

Combination Raised Floor/Wood Floor Box – Provides an Innovative Open Space Solution

861 Series™ Floor Boxes bring power or communication services directly to the point-of-use for open space applications. 861 Series Floor Boxes have been designed for use in both raised and wood-constructed floors and are available with a variety of cover options. These boxes will accept Wiremold flush-style poke-thru cover assemblies which are available in dedicated power, communication or pass-through versions. They will also accept 895 and 896 Series Single Service Covers that are available in brass, brushed aluminum, and nonmetallic materials.

861 Series Floor Boxes are an ideal solution for bringing power or communication to board rooms, commercial offices or upscale residences. And all 861 Series Floor Boxes include TopGuard protection, an industry-leading design that not only meets but exceeds UL scrub water exclusion requirements for tile, wood, and carpeted floors.



861 Series Floor Box – an ideal solution for power or communication needs.

FEATURES & BENEFITS

- **Individual slide covers on flush poke-thru-style cover assemblies.** Protects power and communication devices. Power slide cover snaps back into place when receptacle is not in use. 861AMDTC Floor Box is the only all-communications unit available with slide cover protection.
- **Suitable for use in air-handling spaces.** In accordance with Sec. 300-22(C) of the National Electrical Code.
- **Provides flexibility with a single floor box unit.** 861QTC has a 15A quad receptacle that can be wired in either standard or isolated ground configuration.
- **“Step-on-it” installation.** Reduces labor cost by eliminating the need for a routed opening on carpet and tile applications or special tools for installation. Allows all wiring to be completed at floor level.
- **Meets ADA Accessibility Guidelines.** The trim flanges for this product have been designed to meet the ADA Accessibility Guidelines as it pertains to ADA Standard 4.5 which addresses changes in floor and ground surface levels. The poke-thru trim flanges are beveled so the slope is no greater than 1:2 ratio.
- **Reusable and accessible flip top disposable cover plate.** Prevents unit from seating too far into the sub floor. Saves time and money during installation by allowing wire connections to be made at the time of installation, prior to activating the floor box.
- **Supported by one of the most complete lines of activation covers in the industry.** Compatible with 895 and 896 Series Covers that are available in brass, brushed aluminum, and polycarbonate, as well as a variety of aesthetically-pleasing flush, poke-thru style cover options to meet any decor and can accommodate most power or data requirements.
- **Datacom connectivity option.** Accepts industry standard and proprietary devices from a wide range of manufacturers to provide a seamless and aesthetically pleasing interface for voice, data, audio and video applications at the point-of-use.
- **TopGuard protection.** An integral design which keeps out water, dirt, and debris from the power and communication compartments. Whenever you see the TopGuard protection icon applied to any Wiremold product, you will know that the product meets and exceeds the new UL scrub water exclusion requirement.
- **UL Listed to U.S. and Canadian safety standards for tile, terrazzo, and the UL requirements under UL514A and UL514C for the scrub water exclusion test for carpet and wood floors.**



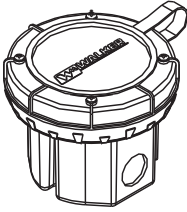
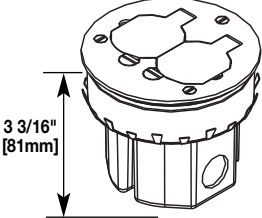
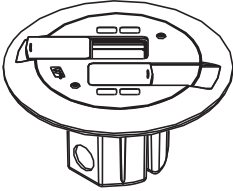
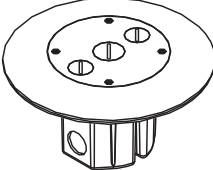
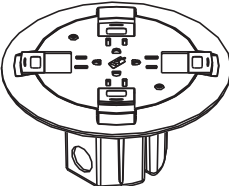

Protection from water, dirt, and debris.

861 Series Floor Box Ordering Information

Catalog No./Item	Description/Specifications
<p>861</p> 	<p>Raised Floor/Wood Floor Box – Die-cast aluminum construction with three 1/2" trade size knockouts; two on the sides and one on the bottom. 18 cu. in. [295 cu. cm] capacity. Requires a 4" [102mm] diameter hole. Comes complete with a disposable cover. Receptacle and activation sold separately.</p>
<p>861DB</p> 	<p>Raised Floor/Wood Floor Box Assembly – Complete with 20A duplex receptacle and brass cover plate. Die-cast aluminum construction with three 1/2" trade size knockouts; two on the sides and one on the bottom. 18 cu. in. [295 cu. cm] capacity. Requires a 4" [102mm] diameter hole.</p>
<p>861AMDTCGY 861AMDTCBK 861AMDTCAL 861AMDTCBS 861AMDTCAB 861AMDTCVY</p> 	<p>Raised Floor/Wood Floor Box Assembly – All communication floor boxes accept up to four UTP connectors. Flush flanges available in painted gray (GY), black (BK), ivory (VY), or brushed metal finishes in aluminum (AL) and brass (BS). Slide covers match painted flange colors: gray, black. Aluminum and brass flanges shipped with black slide cover. Brass flange also available with nonmetallic brass-color (AB) slide holder. Die-cast aluminum construction with three 1/2" trade size knockouts; two on the sides and one on the bottom. 18 cu. in. [295 cu.cm] capacity. Requires a 4" [102mm] diameter hole. Includes two (2) Wiremold Open System adapters, two (2) Ortronics® TracJack adapters and two (2) Ortronics® Series II adapters.</p>
<p>NOTE: Assembled with scrub water gasket. For use in floors with tile, wood, or carpet covering.</p>	<p>NOTE: Assembled with scrub water gasket. For use in floors with tile, wood, or carpet covering.</p>
<p>861FFTCGY 861FFTCBK 861FFTCAL 861FFTCBS 861FFTCVY</p> 	<p>Furniture Feed Raised Floor/Wood Floor Box Assembly – Cover has two 1/2" trade size conduits and one 3/4" trade size threaded conduit opening for feeding cables and wires through floor. Flush flanges available in painted gray (GY), black (BK), ivory (VY), or brushed metal finishes in aluminum (AL) and brass (BS). Die-cast aluminum construction with three 1/2" trade size knockouts; two on the sides and one on the bottom, 18 cu. in. [295 cu. cm] capacity. Requires a 4" [102mm] diameter hole.</p>
<p>NOTE: Assembled with scrub water gasket. For use in floors with tile, wood, or carpet covering.</p>	<p>NOTE: Assembled with scrub water gasket. For use in floors with tile, wood, or carpet covering.</p>
<p>861QTCGY 861QTCBK 861QTCAL 861QTCBS 861QTCAB 861QTCVY</p> 	<p>Raised Floor/Wood Floor Box Assembly – Complete with prewired 15A quad receptacle can be wired as standard or isolated ground. Flush cover is available in painted gray (GY), black (BK), ivory (VY), or brushed metal finishes in aluminum (AL) and brass (BS). Slide covers match painted flange colors: gray, black. Aluminum and brass flanges shipped with black slide cover. Brass flange also available with nonmetallic brass color slide holder (AB). Die-cast aluminum construction with three 1/2" trade size knockouts; two on the sides and one on the bottom, 18 cu. in. [295 cu. cm] capacity. Requires a 4" [102mm] diameter hole.</p>
<p>NOTE: Assembled with scrub water gasket. For use in floors with tile, wood, or carpet covering.</p>	<p>NOTE: Assembled with scrub water gasket. For use in floors with tile, wood, or carpet covering.</p>

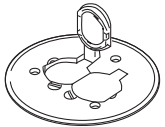
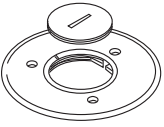
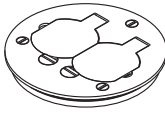
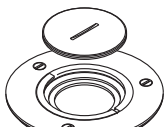
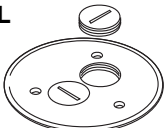
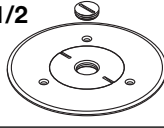
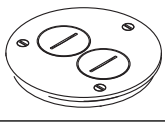
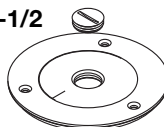
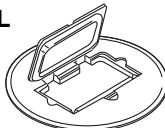
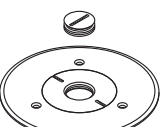
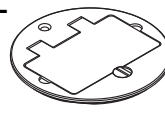
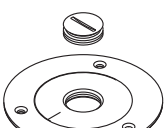
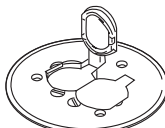
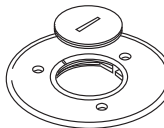
861 Series Floor Boxes Single Service Cover Plates Ordering Information

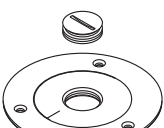
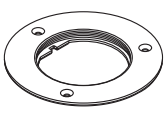
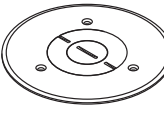
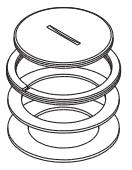
Catalog No./Item	Description/Specifications	Catalog No./Item	Description/Specifications
895 895TCAL	 Duplex Cover Plate with Flip Lids – Brass (895) or brushed aluminum (895TCAL) duplex cover plate with flip lids, 5 1/2" [140mm] for carpet.	896CK	 Cover Plate – Brass communication or power cover plate with 2 1/4" [57mm] threaded opening for carpet.
895T 895TAL	 Duplex Cover Plate with Flip Lids – Brass (895T) or brushed aluminum (895TAL) duplex cover plate with flip lids, 4 1/4" [108mm] for tile.	896TCK	 Cover Plate – Brass communication or power cover plate with 2 1/4" [57mm] threaded opening for tile.
895SP 895SPCAL	 Cover Plate with Two Screw Plug Openings* – Brass (895SP) or brushed aluminum (895SPAL) cover plate with two screw plug openings, 5 1/2" [140mm] diameter for carpet.	896CK-1/2 896CKAL-1/2	 Cover Plate – Brass or brushed aluminum cover plate with 1/2" [12.7mm] threaded opening for tile.
895TSP	 Cover Plate with Two Screw Plug Openings – Brass cover plate with two screw plug openings, 4 1/4" [108mm] for tile.	896TCK-1/2 896TCKAL-1/2	 Cover Plate – Brass or brushed aluminum cover plate with 1/2" [12.7mm] threaded opening for tile.
895GFI 895GFICAL	 GFI Receptacle Cover Plate – Brass (895GFI) or brushed aluminum (895GFICAL) GFI receptacle cover plate, 5 1/2" [140mm] for carpet.	896CK-3/4	 Cover Plate – Brass cover plate with 3/4" [19.1mm] threaded opening for carpet.
895TGFI 895TGFIAL	 GFI Receptacle Cover Plate – Brass (895TGFI) or brushed aluminum (895TGFIAL) GFI receptacle cover plate, 4 1/4" [108mm] for carpet.	896TCK-3/4	 Cover Plate – Brass cover plate with 3/4" [19.1mm] threaded opening for tile.
895P-BLK 895P-BRN 895P-BRZ 895P-AL	 Duplex Cover Plate with Flip Lids – Black polycarbonate duplex cover plate with flip lids for carpet. [140mm] diameter. Cover available in black (BLK), brown (BRN), bronze (BRN) and aluminum (AL).	896CK-1	 Cover Plate – Brass cover plate with 1" [25mm] threaded opening for carpet.
896	 Cover Plate – Brass communication or power cover plate with 2 5/8" [67mm] threaded opening for carpet. Abandonment Plug (825CK) sold separately.	896TCK-1	 Cover Plate – Brass cover plate with 1" [25mm] threaded opening for tile.
896T	 Cover Plate – Brass communication or power cover plate with 2 5/8" [67mm] threaded opening for tile. Abandonment Plug (825CK) sold separately.	896PCK-BLK 896PCK-BRN 896PCK-BRZ 896PCK-AL	 Brass Polycarbonate Communications or Power Plate – One plug with 1 1/8" [29mm] opening, one plug with 1 15/16" [33mm] opening for pass-through only. Available in black (BLK), brown (BRN), bronze (BRZ) and aluminum (AL).
		825CK	 Conversion Kit – Brass conversion kit includes plug, adapter ring, gaskets, and gasket support plate. For carpet or tile installations.

NOTE: All 895 Series Cover Plates are furnished with gasket and three screws. All carpet cover plates are 5 1/2" [140mm] in diameter. All tile cover plates are 4 1/4" [108mm] in diameter.

Flush Quad Power Poke-Thru Style Cover Ordering Information

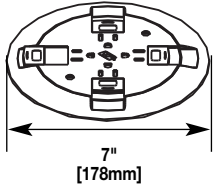
Catalog No./Item	Description/Specifications
RC9CTCGY RC9CTCBK RC9CTCAL RC9CTCBS RC9CTCAB RC9CTCVY RC9CTCAA	<p>Finish Flange & Slide Holder Assembly - Flange available in painted gray (GY), black (BK), ivory (VY), and brushed metal finishes in aluminum (AL) and brass (BS). Aluminum and brass flanges shipped with black cover. Brass flange also available with brass colored cover assembly (AB). Aluminum flange also available with aluminum colored cover assembly (AA).</p> <p>NOTE: Quad Receptacle sold separately. When RC9CTC is ordered for the 861 Wood Floor Box the RC9REC must be purchased at the same time.</p>
	<p>NOTE: Assembled with scrub water gasket. For use in floors with tile, wood, or carpet covering.</p>

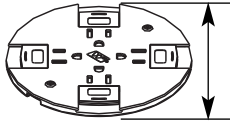
Catalog No./Item	Description/Specifications
RC9SHTCGY RC9SHTCBK RC9SHTCBS RC9SHTCVY RC9SHTCAA	<p>Nonmetallic Slide Holder Assembly - Available in gray (GY), black (BK), ivory (VY), nonmetallic brass (BS) and nonmetallic aluminum (AA).</p> <p>NOTE: Assembled with scrub water gasket. For use in floors with tile, wood, or carpet covering.</p>
	

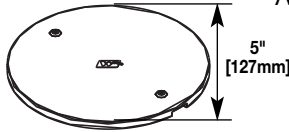
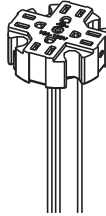
Catalog No./Item	Description/Specifications
RC9APTCBK	<p>Abandonment Plate - Available in black (BK).</p> 
RC9REC	<p>Replacement Receptacle - Prewired 15A quad receptacle can be wired as standard receptacle or isolated ground. Available only in black. See installation instructions with replacement receptacle for complete installation details.</p>  <p>NOTE: When ordering the RC9REC to assemble into the 861 a RC9CTC must be purchased at the same time.</p>

Flush Communication Poke-Thru Style Cover Ordering Information

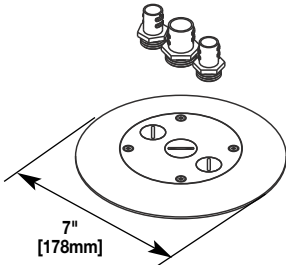
Catalog No./Item	Description/Specifications
RC7CFFTCGY RC7CFFTCBK RC7CFFTCAL RC7CFFTCBS	<p>Finish Flange & Conduit Adapter Assembly - Complete with one 3/4" [19.1mm] conduit and two 1/2" trade size adapters and closure plugs. Colors available in painted black (BK), gray (GY), forged brushed aluminum (AL), and brass (BS). Use with RC7STC Insert to form a complete poke-thru assembly.</p>
	<p>NOTE: Assembled with scrub water gasket. For use in floors with tile, wood, or carpet covering.</p>

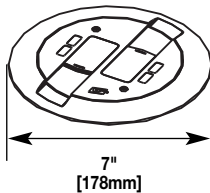
Catalog No./Item	Description/Specifications
RC9CMDTCGY RC9CMDTCBK RC9CMDTCAL RC9CMDTCBS RC9CMDTCAB RC9CMDTCVY RC9CMDTCAA	<p>Finish Flange & Slide Holder Assembly - Flange available in painted gray (GY), black (BK), ivory (VY), and brushed metal finishes in aluminum (AL) and brass (BS). Aluminum and brass flanges shipped with black cover. Brass flange also available with brass colored cover assembly (AB). Aluminum flange also available with aluminum colored cover assembly (AA). Includes two (2) Wiremold Open System inserts. Includes bezels to accept four (4) Ortronics® TracJack inserts, and bezels to accept two dual Ortronics® Series II modular inserts. TracJack and Series II devices sold separately.</p>
	<p>NOTE: Assembled with scrub water gasket. For use in floors with tile, wood, or carpet covering.</p>

861 Series Floor Boxes Exploded Views

Flush Communications Poke-Thru Style Exploded Views

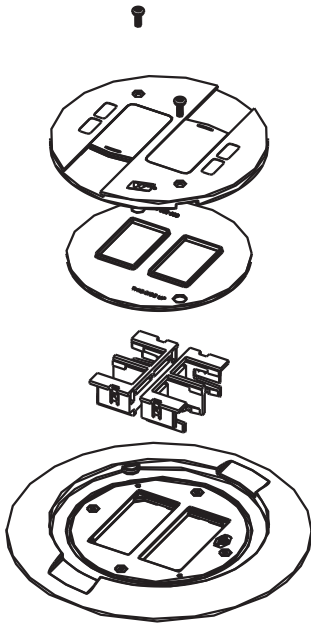

NOTE: RC9CMDTC Cover Assembly shown with two Ortronics® TracJack bezels. (Modular adapters sold separately.)

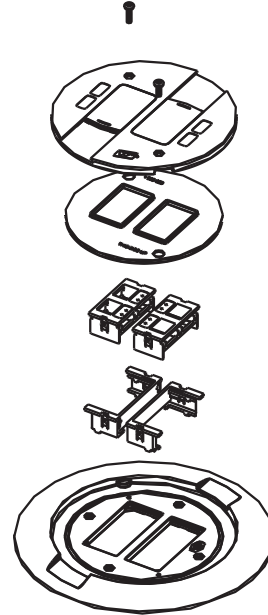

NOTE: RC9CMDTC Cover Assembly shown with Wiremold® Open System inserts. (Modular adapters sold separately.)

Flush Quad Power Poke-Thru Style Exploded View

RC9CTC Cover Assembly

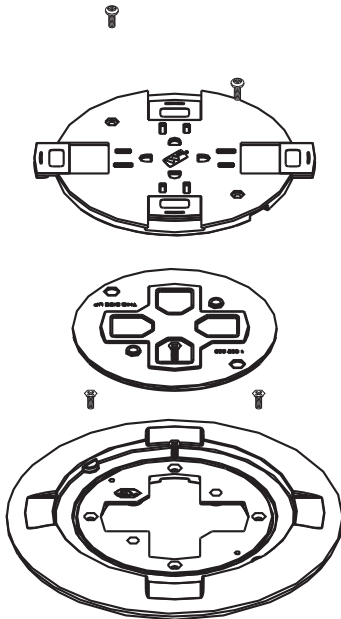

Single Service Floor Box Exploded View

861 Box Assembly

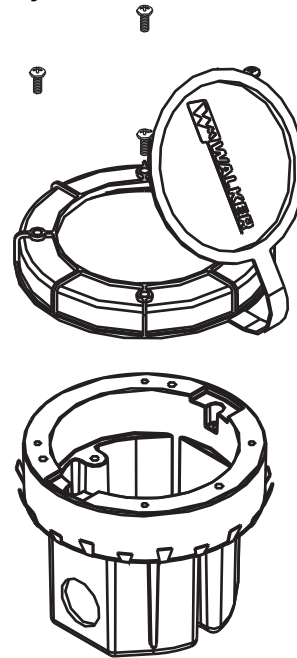

861 Series Floor Boxes Exploded Views (continued)

Single Service Wood Floor Box Exploded View

861DB Box Assembly

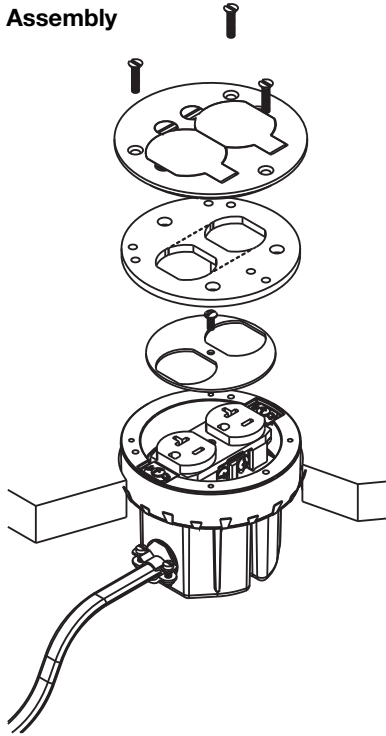

Flush Quad Power Poke-Thru Style Floor Box Exploded View

861QTC Box Assembly

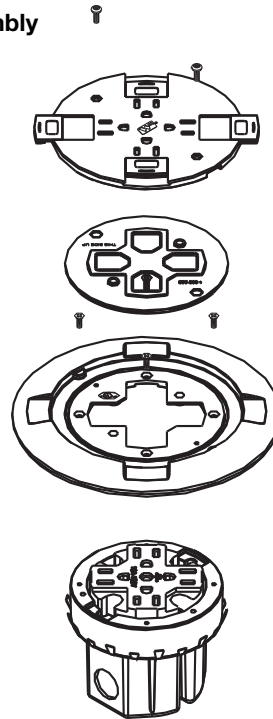

Flush Communications Poke-Thru Style Series Exploded Views

Open System

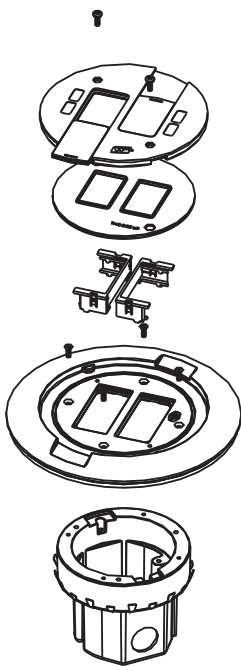

NOTE: 861AMDTC Box Assembly shown with adapter that holds the Activate and Open System inserts

Ortronics®

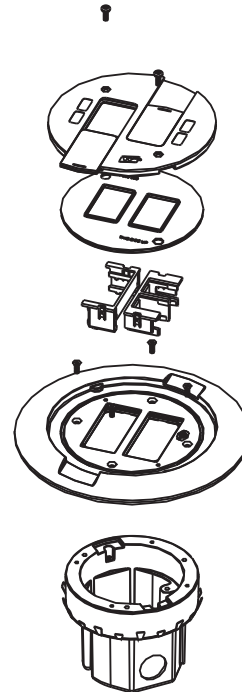

NOTE: 861AMDTC Box Assembly shown with Ortronics® Series II and TracJack adapters.

NOTES



Electrical Wiring Systems

60 Woodlawn Street
West Hartford, CT 06110
Phone: 1.877.BY.LEGRAND (295-3472)
www.legrand.us

570 Applewood Crescent
Vaughan, Ontario L4K 4B4
Phone: 905.738.9195
www.legrand.ca

ED786R9 - Updated August 2013 - For latest specs visit www.legrand.us/wiremold

© Copyright 2013 Legrand All Rights Reserved

