

# Ocal

## GREENLEE ELECTRIC BENDER

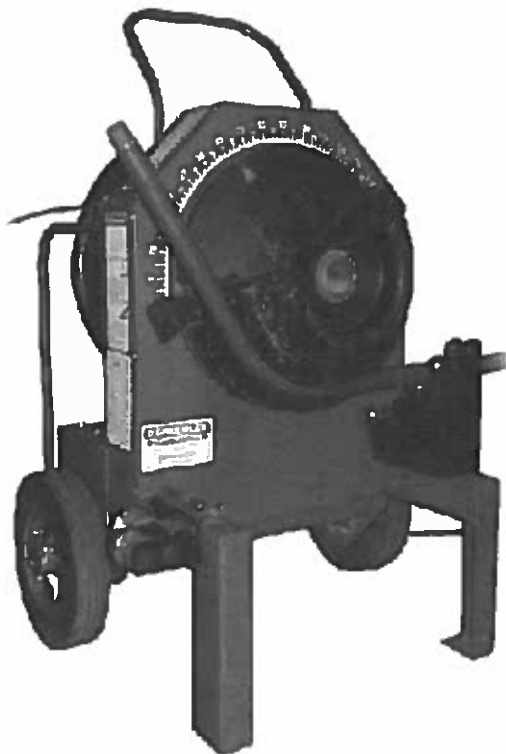

GBENDER

CAT. NO.	DESCRIPTION
GBENDER	GREENLEE MODEL 555 ELECTRIC BENDER (FOR PVC-COATED CONDUIT)
	SHOES AND ROLLER KIT FOR 40 MIL PVC-COATED CONDUIT
37279	SHOES & ROLLER SUPPORTS, CONDUIT SIZE 1/2 THROUGH 2
	KIT CONSISTS OF ONE EACH:
00946	ROLLER SUPPORT, CONDUIT SIZE 1/2 THROUGH 1-1/4
00573	SHOE, CONDUIT SIZE 1/2 THROUGH 1-1/4
37281	SHOE, CONDUIT SIZE 1-1/2 AND 2
37282	ROLLER SUPPORT, CONDUIT SIZE 1-1/2 THROUGH 2
23818	METAL STORAGE BOX

### GENERAL NOTES

1. ALL DIMENSIONS ARE FOR REFERENCE ONLY.
2. DIMENSIONS IN BRACKETS [ ] ARE IN METRIC UNITS.

### REVISIONS

3. SEE ERN 2012996 FOR APPROVAL SIGNATURES & RELEASE DATE.  
PROJECT NO: RM401876

[www.inb.com](http://www.inb.com)

**Thomas & Betts**  
A Member of the ABB Group

DESCRIPTION:

## OCAL INSTALLATION TOOLS

ORIGINAL PROJECT NO / ( ERN NO )

RD55861 / ( 2016562 )

SHEET NO:

1 OF 12

REV. NO:

3

DRAWING NO:

WSD-000413

THIS DRAWING IS INTENDED FOR DESCRIPTIVE PURPOSES ONLY, AND THE RIGHT IS RESERVED TO DEVIATE FROM ANY OF THE DETAILS SHOWN HEREON.  
COPYRIGHT THOMAS & BETTS CORPORATION. ALL RIGHTS RESERVED. PROPRIETARY AND CONFIDENTIAL.

# HAND BENDERS



CAT. NO.	DESCRIPTION
35220	HAND BENDER, CONDUIT SIZE 1/2 (FOR PVC-COATED CONDUIT)
35225	HAND BENDER, CONDUIT SIZE 3/4 (FOR PVC-COATED CONDUIT)
2424A8	HAND BENDER, CONDUIT SIZE 1 (FOR PVC-COATED CONDUIT)

<b>Thomas &amp; Betts</b> A Member of the ABB Group	
<a href="http://www.tnb.com">www.tnb.com</a>	
DESCRIPTION: <b>OCAL INSTALLATION TOOLS</b>	
SHEET NO: 2 OF 12	REV. NO: 3
DRAWING NO: <b>WSD-000413</b>	

THIS DRAWING IS INTENDED FOR DESCRIPTIVE PURPOSES ONLY. AND THE RIGHT IS RESERVED TO DEVIATE FROM ANY OF THE DETAILS SHOWN HEREON.  
 COPYRIGHT THOMAS & BETTS CORPORATION. ALL RIGHTS RESERVED. PROPRIETARY AND CONFIDENTIAL.

# RHINO HIGH-PERFORMANCE THREADING MACHINE

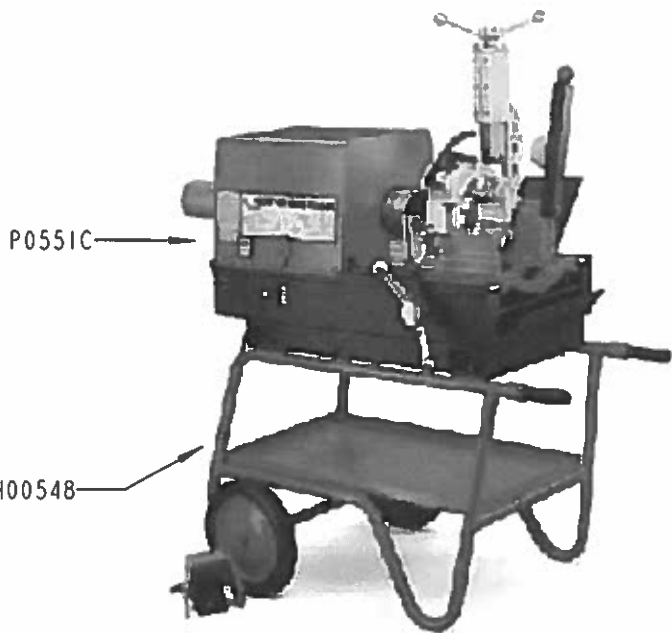

P0551C

ROTH00548



P20305C



ROTH02385

THREADING MACHINE WITH BUILT-IN PIPE CUTTER, REAMER, FOOT-OPERATED SAFETY SWITCH, 1/2 TO 2 AND 2-1/2 TO 4 AUTOMATIC DIE HEADS & PRECISION ALLOY DIES.

HEAVY-DUTY, 115V AC/DC, 50/60 Hz MOTOR DEVELOPS UP TO 3 HP.

COLLONS SUPER GRIP R/L CHUCKING SYSTEM FEATURES 4 HEAVY-DUTY JAWS, SPECIALLY DESIGNED FOR PVC-COATED CONDUIT, AT FRONT & REAR TO AUTOMATICALLY GRIP AND CENTER PIPE.



89101  
89102  
59912

CAT. NO.	DESCRIPTION
RHINO HIGH-PERFORMANCE THREADING MACHINE	
P00551C	RHINO THREADING MACHINE WITH JAWS, CONDUIT SIZE 1/2 THROUGH 4 (FOR PVC-COATED CONDUIT)
ROTH00548	OPTIONAL WHEELED STAND WITH TOOL TRAY (FOR RHINO THREADING MACHINE)
REPLACEMENT THREADING DIE SETS (FOR RHINO THREADING MACHINE)	
89101	THREADING DIE SET, CONDUIT SIZE 1/2 AND 3/4
89102	THREADING DIE SET, CONDUIT SIZE 1 THROUGH 2
59912	THREADING DIE SET, CONDUIT SIZE 2-1/2 THROUGH 4
REPLACEMENT JAW SETS (FOR RHINO THREADING MACHINE)	
P20305C	JAW SET (8 PIECES), FOR PVC-COATED CONDUIT
ROTH02385	JAW SET (8 PIECES), FOR GALVANIZED RIGID CONDUIT



**Thomas & Betts**  
A Member of the ABB Group

www.tnb.com

DESCRIPTION: **OCAL INSTALLATION TOOLS**

SHEET NO:	REV. NO:	DRAWING NO:
3 OF 12	3	<b>WSD-000413</b>

THIS DRAWING IS INTENDED FOR DESCRIPTIVE PURPOSES ONLY, AND THE RIGHT IS RESERVED TO DEVIATE FROM ANY OF THE DETAILS SHOWN HEREON. COPYRIGHT THOMAS & BETTS CORPORATION, ALL RIGHTS RESERVED. PROPRIETARY AND CONFIDENTIAL.

# SUPERTRONIC 2000 POWER THREADER

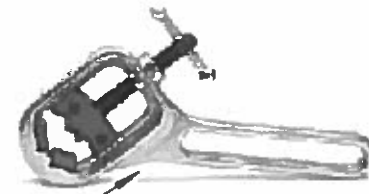

SAFE VISE (P00077C) IS INCLUDED WITH THE POWER THREADER SET.



FORGED PIPE CLAMP (71280) IS INCLUDED WITH THE POWER THREADER SET.

COMPLETE SET INCLUDES SUPERTRONIC 2000, FORGED PIPE CALMPS, SAFE VISE, THREAD-CUTTING SPRAY, QUICK-CHANGE DIE HEADS WITH TEMPERED-STEEL PRECISION DIES FOR TRADE SIZE 1/2 THROUGH 2 AND PVC-COATED CONDUIT AND CARRYING CASE.

15-25 RPM THREADING SPEED WITH 60 RPM RAPID REVERSE FOR TIME SAVINGS.

DUST-TIGHT CASING WITH SEALED LUBRICATION ENSURES LONG SERVICE LIFE AND LOW MAINTENANCE.

CAT. NO.	DESCRIPTION
P71259C	SUPERTRONIC 2000 POWER THREADER SET, CONDUIT SIZE 1/2, 3/4, 1, 1-1/4, 1-1/2 AND 2 (FOR PVC-COATED CONDUIT)

<b>Thomas &amp; Betts</b> A Member of the ABB Group			
<a href="http://www.tnb.com">www.tnb.com</a>			
DESCRIPTION: <b>OCAL INSTALLATION TOOLS</b>			
	SHEET NO: <b>4 OF 12</b>	REV. NO: <b>3</b>	DRAWING NO: <b>WSD-000413</b>

THIS DRAWING IS INTENDED FOR DESCRIPTIVE PURPOSES ONLY. AND THE RIGHT IS RESERVED TO DEVIATE FROM ANY OF THE DETAILS SHOWN HEREON. COPYRIGHT THOMAS & BETTS CORPORATION. ALL RIGHTS RESERVED. PROPRIETARY AND CONFIDENTIAL.

# MINI-COLLINS ELECTRIC POWER DRIVE

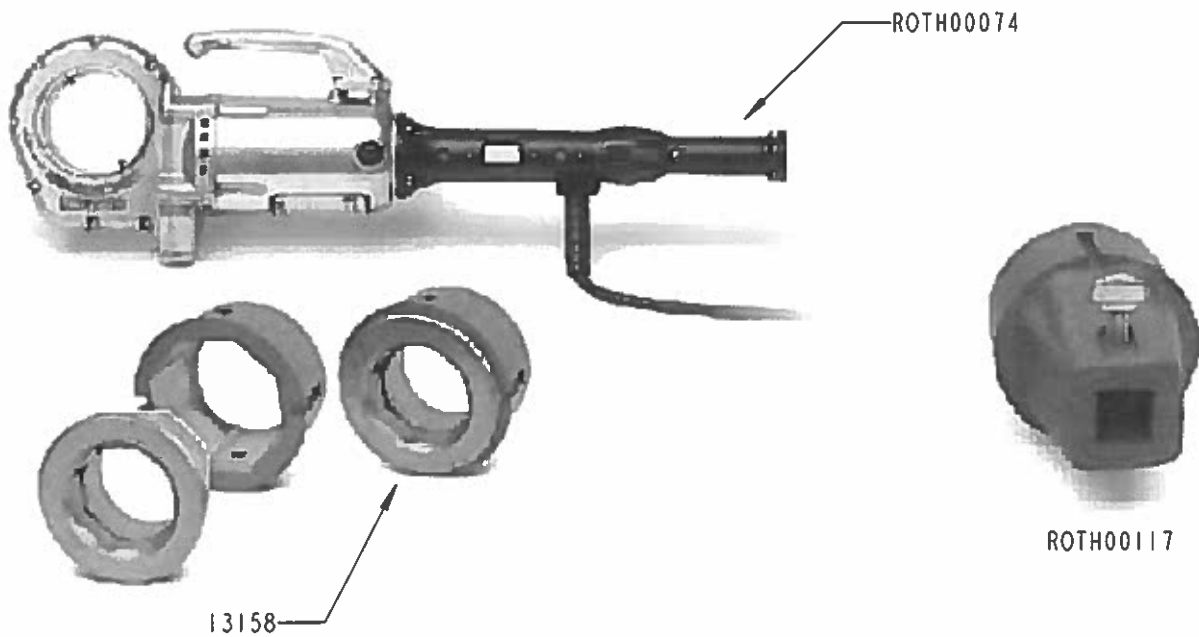

115V, 15A REVERSIBLE MOTOR PROVIDES THE POWER TO MAKE ANY TURNING JOB EASIER.

TIGHTENS NUTS, DRIVES CABLE PULLERS, TURNS HOISTS AND JACKS, OPENS & CLOSES VALVES AND DRIVES UP TO 6" GEARED THREADERS.

COMPATIBLE WITH RIGID 12R DIE HEADS.

CAT. NO. 13158 ADAPTER ENABLES SUPER CUT DIE HEADS TO BE USED WITH ROTHENBERGER MINI-COLLINS AND RIGID MODEL 700 PORTABLE THREADING MACHINES.

CAT. NO.	DESCRIPTION
ROTH00074	MINI-COLLINS ELECTRIC POWER DRIVE, CONDUIT SIZE 1/2 THROUGH 2
13158	MINI-COLLINS ADAPTER FOR SUPER CUT DIE HEADS
ROTH00117	MINI-COLLINS 1" SQUARE SHAFT DRIVE FOR GEARED THREADERS
ROTH00119	STEEL CARRYING CASE FOR MINI-COLLINS

<b>Thomas &amp; Betts</b> A Member of the ABB Group	
www.inb.com	
DESCRIPTION: <b>OCAL INSTALLATION TOOLS</b>	
SHEET NO: 5 OF 12	REV. NO: 3
DRAWING NO: <b>WSD-000413</b>	

THIS DRAWING IS INTENDED FOR DESCRIPTIVE PURPOSES ONLY, AND THE RIGHT IS RESERVED TO DEVIATE FROM ANY OF THE DETAILS SHOWN HEREON. COPYRIGHT THOMAS & BETTS CORPORATION. ALL RIGHTS RESERVED. PROPRIETARY AND CONFIDENTIAL.

# SUPER CUT DIE HEADS



P70905C



P70912C  
P70913C  
P70914C  
P70915C  
P70849C  
P70850C

FIT SUPERTRONIC 2000 THREADER.

USE WITH MINI-COLLINS OR RIGID MODEL 700 WITH CAT. NO. 13158 ADAPTER.

CAT. NO.	DESCRIPTION
P70905C	SUPER CUT DIE HEADS, CONDUIT SIZE 1/2 THROUGH 2 (FOR PVC-COATED CONDUIT)
P70912C	SUPER CUT DIE HEAD, CONDUIT SIZE 1/2 (FOR PVC-COATED CONDUIT)
P70913C	SUPER CUT DIE HEAD, CONDUIT SIZE 3/4 (FOR PVC-COATED CONDUIT)
P70914C	SUPER CUT DIE HEAD, CONDUIT SIZE 1 (FOR PVC-COATED CONDUIT)
P70915C	SUPER CUT DIE HEAD, CONDUIT SIZE 1-1/4 (FOR PVC-COATED CONDUIT)
P70849C	SUPER CUT DIE HEAD, CONDUIT SIZE 1-1/2 (FOR PVC-COATED CONDUIT)
P70850C	SUPER CUT DIE HEAD, CONDUIT SIZE 2 (FOR PVC-COATED CONDUIT)

<b>Thomas &amp; Betts</b> A Member of the ABB Group	
<a href="http://www.tnb.com">www.tnb.com</a>	
DESCRIPTION: <b>OCAL INSTALLATION TOOLS</b>	
SHEET NO: <b>6 OF 12</b>	REV. NO: <b>3</b>
DRAWING NO: <b>WSD-000413</b>	

THIS DRAWING IS INTENDED FOR DESCRIPTIVE PURPOSES ONLY. AND THE RIGHT IS RESERVED TO DEVIATE FROM ANY OF THE DETAILS SHOWN HEREON.  
COPYRIGHT THOMAS & BETTS CORPORATION. ALL RIGHTS RESERVED. PROPRIETARY AND CONFIDENTIAL.

# TRI-STAND VISES

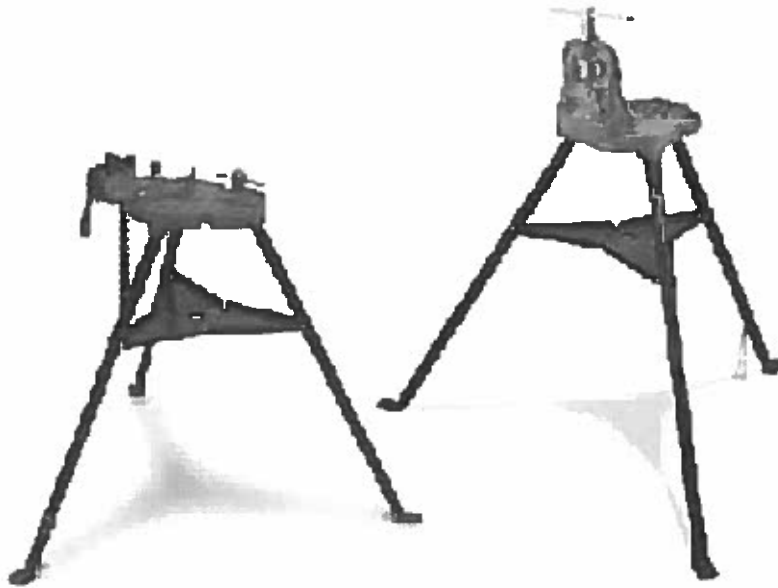

ROTH00076

P00076C

STURDY, STABLE FRAME COLLAPSES FOR EASY MOBILITY AND STORAGE.

CEILING BRACE FOR OVERHEAD SUPPORT ENABLES YOU TO SECURE FRAME EVEN DURING DIFFICULT WORK.

FEATURES RECESSES FOR BENDING TUBES 3/8", 1/2" AND 3/4" O.D.

CAT. NO.	DESCRIPTION
ROTH00076	TRI-STAND WITH 6" CHAIN VISE (USE WITH OCAL JAWS FOR PVC-COATED CONDUIT)
P00076C	TRI-STAND WITH BENCH YOKE VISE (INCLUDES JAWS DESIGNED FOR USE WITH PVC-COATED CONDUIT)

<b>Thomas &amp; Betts</b> A Member of the ABB Group	
<a href="http://www.tnb.com">www.tnb.com</a>	
DESCRIPTION: <b>OCAL INSTALLATION TOOLS</b>	
SHEET NO: 7 OF 12	REV. NO: 3
DRAWING NO: <b>WSD-000413</b>	

THIS DRAWING IS INTENDED FOR DESCRIPTIVE PURPOSES ONLY, AND THE RIGHT IS RESERVED TO DEVIATE FROM ANY OF THE DETAILS SHOWN HEREON.  
COPYRIGHT THOMAS & BETTS CORPORATION. ALL RIGHTS RESERVED. PROPRIETARY AND CONFIDENTIAL.

## OCAL HALF-SHELL CLAMPS (FOR CHAIN VISE CLAMPING)



PATENT-PENDING, CROSS-HATCHED INTERIOR SURFACE GRIPS CONDUIT SECURELY WHILE SAFEGUARDING PVC JACKET FROM DAMAGE.

TWO-PIECE CONSTRUCTION, CAST FROM DUCTILE IRON FOR EXCEPTIONAL STRENGTH, DURABILITY AND PERFORMANCE.

EACH CLAMP CLEARLY MARKED WITH TRADE SIZE FOR EASY IDENTIFICATION.

OPENINGS AT EACH END ENABLE HANGING FOR HANDY STORAGE.

CAT. NO.	DESCRIPTION
INDIVIDUAL HALF-SHELL CLAMPS (FOR PVC-COATED CONDUIT)	
HLF-SHL-CLP1/2	HALF-SHELL CLAMP, CONDUIT SIZE 1/2 (FOR PVC-COATED CONDUIT)
HLF-SHL-CLP3/4	HALF-SHELL CLAMP, CONDUIT SIZE 3/4 (FOR PVC-COATED CONDUIT)
HLF-SHL-CLP1	HALF-SHELL CLAMP, CONDUIT SIZE 1 (FOR PVC-COATED CONDUIT)
HLF-SHL-CLP1-1/4	HALF-SHELL CLAMP, CONDUIT SIZE 1-1/4 (FOR PVC-COATED CONDUIT)
HLF-SHL-CLP1-1/2	HALF-SHELL CLAMP, CONDUIT SIZE 1-1/2 (FOR PVC-COATED CONDUIT)
HLF-SHL-CLP2	HALF-SHELL CLAMP, CONDUIT SIZE 2 (FOR PVC-COATED CONDUIT)
HLF-SHL-CLP2-1/2	HALF-SHELL CLAMP, CONDUIT SIZE 2-1/2 (FOR PVC-COATED CONDUIT)
HLF-SHL-CLP3	HALF-SHELL CLAMP, CONDUIT SIZE 3 (FOR PVC-COATED CONDUIT)
HLF-SHL-CLP3-1/2	HALF-SHELL CLAMP, CONDUIT SIZE 3-1/2 (FOR PVC-COATED CONDUIT)
HLF-SHL-CLP4	HALF-SHELL CLAMP, CONDUIT SIZE 4 (FOR PVC-COATED CONDUIT)
HLF-SHL-CLP5	HALF-SHELL CLAMP, CONDUIT SIZE 5 (FOR PVC-COATED CONDUIT)
HLF-SHL-CLP6	HALF-SHELL CLAMP, CONDUIT SIZE 6 (FOR PVC-COATED CONDUIT)
HALF-SHELL CLAMP SET (IN CARRYING/STORAGE CASE)	
HLF-SHL-CLP-SET1	HALF-SHELL CLAMP SET, CONDUIT SIZE 1/2 THROUGH 2 (FOR PVC-COATED CONDUIT)

<b>Thomas &amp; Betts</b> A Member of the ABB Group	
<a href="http://www.tnb.com">www.tnb.com</a>	
DESCRIPTION: <b>OCAL INSTALLATION TOOLS</b>	
	SHEET NO: <b>8 OF 12</b>
	REV. NO: <b>3</b>
	DRAWING NO: <b>WSD-000413</b>

THIS DRAWING IS INTENDED FOR DESCRIPTIVE PURPOSES ONLY, AND THE RIGHT IS RESERVED TO DEVIATE FROM ANY OF THE DETAILS SHOWN HEREON. COPYRIGHT THOMAS & BETTS CORPORATION. ALL RIGHTS RESERVED. PROPRIETARY AND CONFIDENTIAL.



# OCAL JAWS (FOR YOKE STYLE VISE CLAMPING)

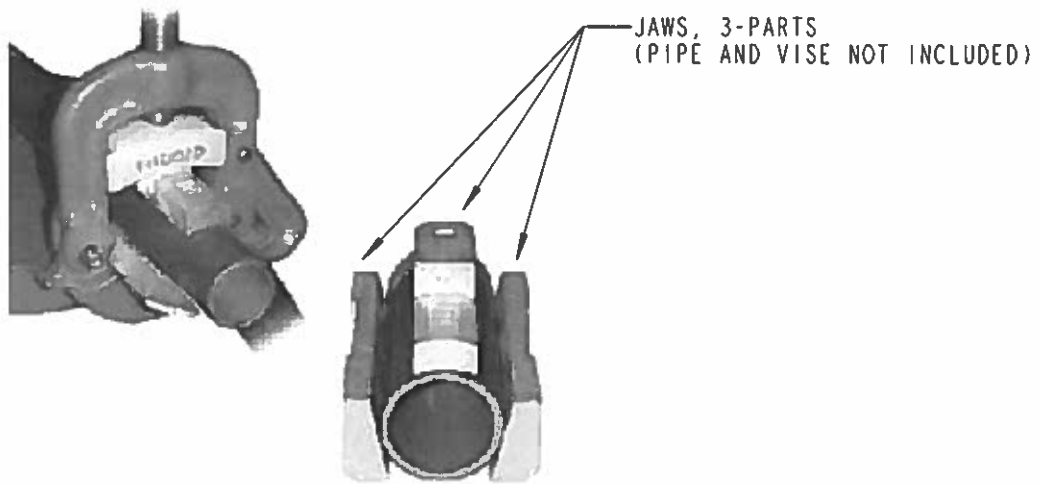

DESIGNED TO HOLD PVC-COATED CONDUIT SAFELY AND SECURELY IN A YOKE-STYLE VISE.  
 REPLACES THE STANDARD JAW INSERTS IN A YOKE VISE.  
 MACHINED ALUMINUM CONSTRUCTION.

CAT. NO.	DESCRIPTION
JAWS23	JAWS, USED WITH RIGID NO. 23 YOKE VISE (FOR PVC-COATED CONDUIT)
JAWS76	JAWS, USED WITH ROTHENBERGER YOKE VISE (FOR PVC-COATED CONDUIT)

<a href="http://www.tnb.com">www.tnb.com</a>	<b>Thomas &amp; Betts</b> A Member of the ABB Group		
DESCRIPTION: <b>OCAL INSTALLATION TOOLS</b>			
	SHEET NO: 9 OF 12	REV. NO: 3	DRAWING NO: <b>WSD-000413</b>

THIS DRAWING IS INTENDED FOR DESCRIPTIVE PURPOSES ONLY, AND THE RIGHT IS RESERVED TO DEVIATE FROM ANY OF THE DETAILS SHOWN HEREON.  
 COPYRIGHT THOMAS & BETTS CORPORATION, ALL RIGHTS RESERVED, PROPRIETARY AND CONFIDENTIAL.

# STEEL PIPE CUTTERS & RATCHET PIPE REAMER



P70045C



70289

SMOOTH RUNNING RATCHET.  
TEMPERED-STEEL CUTTING BIT.

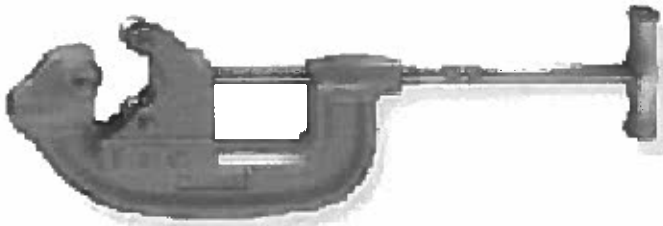

P70060C

EASY PRESSURE CONTROL TRANSMITS OPTIMUM FORCE ONTO TUBE.

HARDENED, HIGH -ALLOY STEEL CUTTER WHEEL PROVIDES LONG SERVICE LIFE AND BURR-FREE EXTERNAL CUTTING.

CAT. NO.	DESCRIPTION
STEEL PIPE CUTTERS (DESIGNED FOR PVC-COATED CONDUIT)	
P70045C	STEEL PIPE CUTTER, PIPE O.D. 1/8" THROUGH 2"
P70060C	STEEL PIPE CUTTER, PIPE O.D. 1/8" THROUGH 4"
RATCHET PIPE REAMER	
70289	RATCHET PIPE REAMER, PIPE O.D. 1/4" THROUGH 4"

<b>Thomas &amp; Betts</b> A Member of the ABB Group		
<a href="http://www.tnb.com">www.tnb.com</a>		
DESCRIPTION: <b>LOCAL INSTALLATION TOOLS</b>		
SHEET NO: <b>10 OF 12</b>	REV. NO: <b>3</b>	DRAWING NO: <b>WSD-000413</b>

# OCAL J-WRENCHES

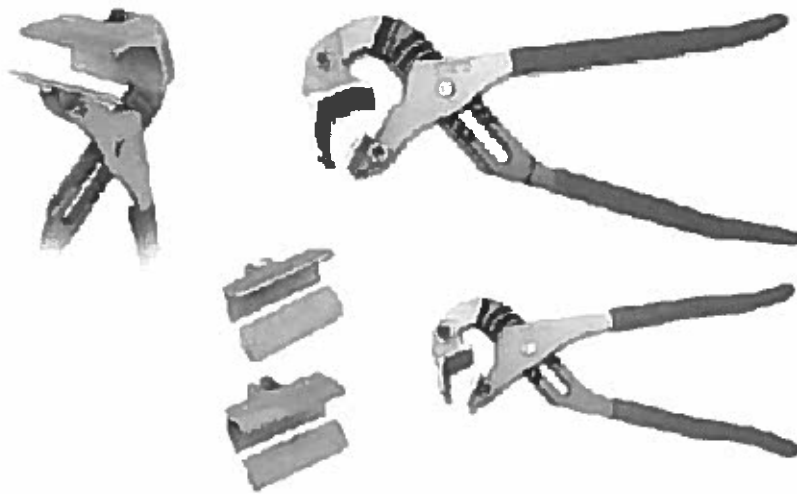

CAT. NO.	DESCRIPTION
OCAL J-WRENCHES (FOR PVC-COATED CONDUIT)	
J442	12" J-WRENCH WITH JAWS, CONDUIT SIZE 1/2 THROUGH 1-1/4
J460	16" J-WRENCH WITH JAWS, CONDUIT SIZE 1-1/2 THROUGH 2-1/2
J42	12" JAW SET ONLY, CONDUIT SIZE 1/2 THROUGH 1-1/4
J60	16" JAW SET ONLY, CONDUIT SIZE 1-1/2 THROUGH 2-1/2

<a href="http://www.tnb.com">www.tnb.com</a>		<b>Thomas &amp; Betts</b> A Member of the ABB Group	
		DESCRIPTION: <b>OCAL INSTALLATION TOOLS</b>	
	SHEET NO: 11 OF 12	REV. NO: 3	DRAWING NO: <b>WSD-000413</b>

THIS DRAWING IS INTENDED FOR DESCRIPTIVE PURPOSES ONLY, AND THE RIGHT IS RESERVED TO DEVIATE FROM ANY OF THE DETAILS SHOWN HEREON. COPYRIGHT THOMAS & BETTS CORPORATION. ALL RIGHTS RESERVED. PROPRIETARY AND CONFIDENTIAL.

## ALUMINUM PIPE WRENCHES

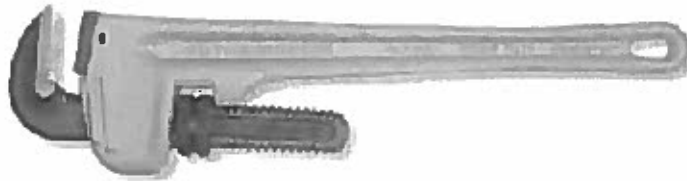

### AL PIPE WRENCHES

EXTREMELY LIGHT ALUMINUM ALLOY OFFERS HIGH STRENGTH BUT WEIGHS 40% LESS THAN STANDARD CAST. SELF-CLAMPING, SPRING-SUPPORTED HOOK FOR EASY, ONE-HANDED, RATCHET-LIKE USE. SCALE ON HOOK FOR QUICK PRESET OF TUBE DIAMETER.



### STRAP WRENCHES

SPECIALLY COATED STRAP WON'T ABSORB OIL.

CAT. NO.	DESCRIPTION
ALUMINUM PIPE WRENCHES (FOR PVC-COATED CONDUIT)	
P70159C	10" AL PIPE WRENCH, STEEL TUBE O.D. 1-1/2" MAX.
P70160C	14" AL PIPE WRENCH, STEEL TUBE O.D. 2" MAX.
P70161C	18" AL PIPE WRENCH, STEEL TUBE O.D. 2-1/2" MAX.
P70162C	24" AL PIPE WRENCH, STEEL TUBE O.D. 3" MAX.
RIGID STRAP WRENCHES	
31355	RIGID STRAP WRENCH, 11.75" HANDLE LENGTH, 1.75" STRAP WIDTH, 3.50" O.D. PIPE CAPACITY
31370	RIGID STRAP WRENCH, 18" HANDLE LENGTH, 1.75" STRAP WIDTH, 5.50" O.D. PIPE CAPACITY

<b>Thomas &amp; Betts</b> A Member of the ABB Group	
<a href="http://www.inb.com">www.inb.com</a>	
DESCRIPTION: <b>LOCAL INSTALLATION TOOLS</b>	
SHEET NO: <b>12 OF 12</b>	REV. NO: <b>3</b>
DRAWING NO: <b>WSD-000413</b>	

THIS DRAWING IS INTENDED FOR DESCRIPTIVE PURPOSES ONLY. AND THE RIGHT IS RESERVED TO DEVIATE FROM ANY OF THE DETAILS SHOWN HEREON. COPYRIGHT THOMAS & BETTS CORPORATION. ALL RIGHTS RESERVED. PROPRIETARY AND CONFIDENTIAL.