

NETWORK

product solutions

4

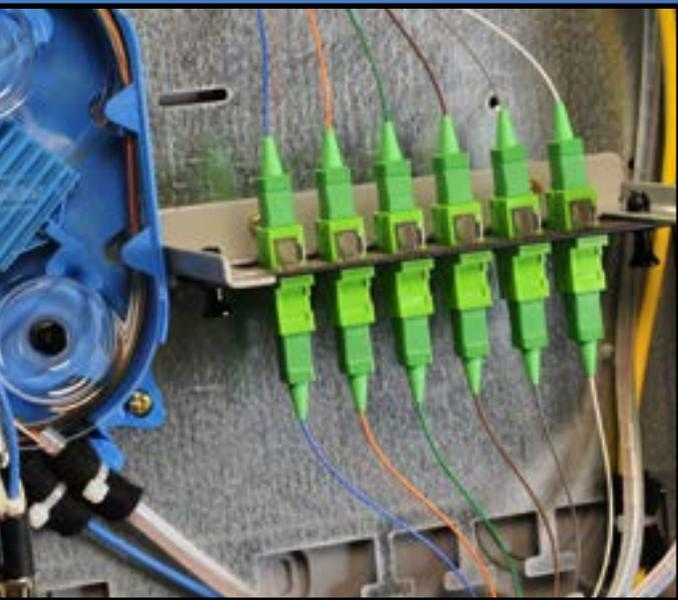
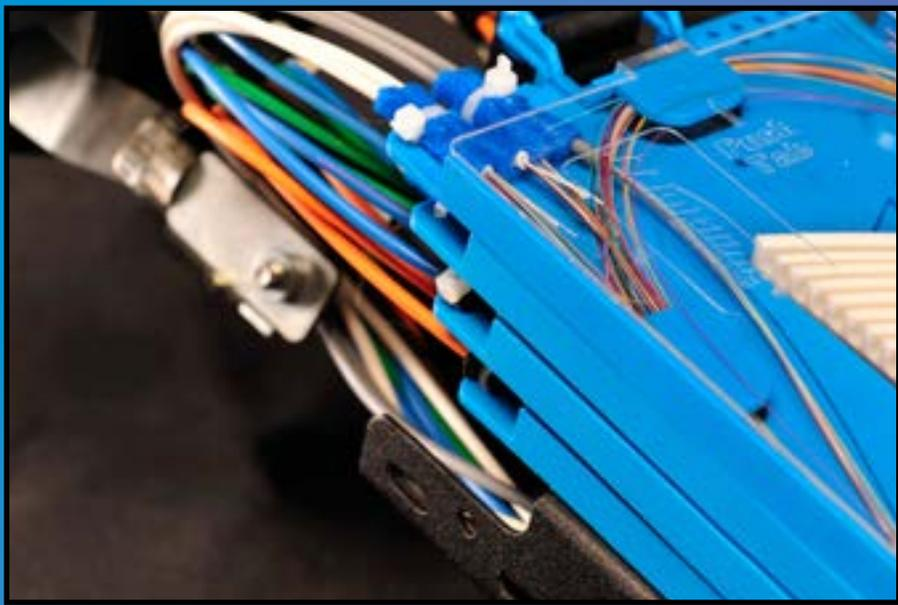

PROVEN QUALITY SINCE 1983

WWW.GOMULTILINK.COM

Multilink
Innovation At Work

Worldwide Distribution of Multilink Products



- *Specialized Custom Solutions*
- *Six Sigma Methodology in Quality Standards*
- *Manufacturing*
- *Logistics Services*



**"Made In America,
For The World"**

Contact Us |

North America	Europe, Middle East & Africa	Latin & South America
Tel: +1 440 366 6966 Fax: +1 440 366 6802 Email: engsupport@gomultilink.com	Tel: +1 440 366 6966 Fax: +1 440 366 6802 Email: engsupport@gomultilink.com	Tel: +1 954 499 9203 Mobile: +1 305 684 2388 Email: hquinones@gomultilink.com



MADE IN AMERICA

Dear Valued Customers,

The birth of Multilink in 1983 would not have been possible without you, our valued customers. From our first patented coring and stripping tool in 1991, to our patented true UPS power supplies in 1999, and now on to our newest fiber innovations in 2013, you have been there to support our innovative spirit.

We have seen a lot as the market and technology continually change directions. We know that every change presents new challenges for you and changes what we need to offer for you to get the job done. It is our core responsibility, at Multilink, to build the right product to meet your needs while maintaining the premium quality you expect from Multilink, and offering those products to you at an acceptable price. Each year we continue to put funding back into our Research and Development department to make sure we can, and will, keep our product offerings current with the needs of the market.

Let us hope the next 30 years will continue to benefit you and Multilink as we continue the journey of innovation, and you can count on us to continue to stand behind our products, logistics, and custom solutions for you, our valued customers.

Sincerely,



Steve Kaplan
CEO

Building the Right Product Solutions for You

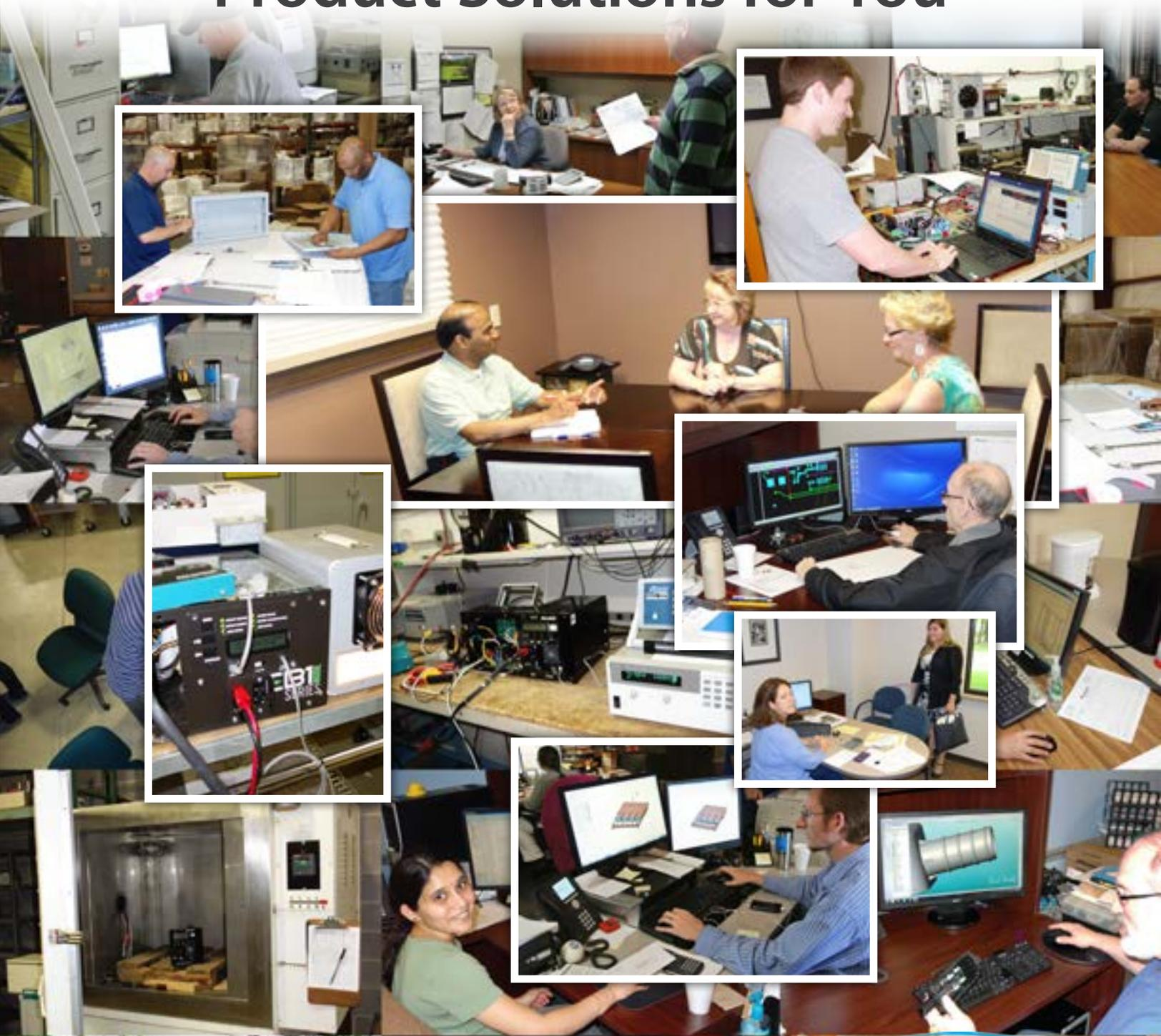



Patents & Innovations

2013	Automatic Lock Configuration Splice Tray
2012	Telecommunications Mounting Enclosure - Pat# 8,254,567 B2
2011	Cable And Overlay Molding - Pat# 7,908,806 Downspout Raceway System - Pat# 7,964,804 B2 Industry's First Online Fiber Box Configurator
2010	Flex Grid Internal Mounting on Plastic Boxes
2009	Slack Cable Storage Box - Pat# 7,477,829 B2
2008	Slack Cable Storage Box w/ Adjustable Height Spools - Pat# 7,359,611 B1 Slack-N-Roll Storage Device Dual Wall Heat Transfer System For Outdoor Enclosures Downspout Raceway
2007	First Web Video Installation Training For Fusion Splicing Training First Web Video Installation Instruction Training For Power Supply FTTx Fiber Optic Slack Storage Enclosure FTTx Overlay Molding For Existing Molding FTTx Exterior Fiber Optic Slack Storage Enclosure
2005	Drop Fiber Sno-Shoe - Pat# D450,042S Multipath Pavement Duct System 5 Amp Min. Stand By Power Supply Direct Core Cooling Open Face Molding
2004	Compression Seal Technology Dome Enclosure Tech Bag For Handling Converters
2002	Communication Cable Clip - Pat# 6,378,814 B1
2001	Battery Power Supply Source Of Uninterruptible Power Supply - Pat# 6,268,665 B1
2000	Release Of 1st Airflow Power Supply Cabinet - Pat# 6,932,443 B1
1999	Patented The 1st UPS With Polarity Of Inverters CCP Tech - Pat# 5,994,793
1998	Fiber Optic Splice Case - Pat# 5,732,180
1997	First Cable Identification Tag - Pat# 387,811
1993	Patented And Trademarked First Plastic Sno-Shoe - Pat# 5,408,571 Architectural Cove Molding For Housing Cable Wires - Pat# D332,941
1992	Patented First Low Cost Torque Wrench - Pat# 5,152,200
1991	Patented Coring And Stripping Tool For Dielectric Cable - Pat# 5,023,995

Table of Contents

Rack Mount Fiber Enclosures	9-19
Wall Mount Fiber Enclosures	20-29
Splice Trays	30-31
Fiber Pedestals	32
Pre-Terminated Configuration	33-35
Loaded Adapter Panels	36-38
Blank Adapter Panels	39
Adapters	40-41
CT-X Modules	42-47
Fiber Termination Modules & Splitters	48-50
Pigtails & Jumpers	51-58
Fiber Tools & Accessories	59-61
Fiber Management	62-63
Rack Mount Cable Managers	64-67
Starfighter Splice Closures	69-81
Splice Trays	82-83
Grounding/Bonding	84
Slack Storage	85-87
Cable Identification	88-90
Environmentally Controlled Enclosures	91-108
Traffic Products	109-122
Multi-Dwelling Units	123-144
Plastic Demarcation Enclosures	145-159
Gel-Seal	161-162
Drop Splice Hardware & Accessories	163-166
Raceway	167-199
Raceway Accessories	200-202
Tools & Accessories	203-206
Terms & Conditions of Sale	207



Multilink's Family of Rack Mount Enclosures



Application

The Multilink family of rack mounted optical termination and in-rack splice enclosures are designed for the interconnection of patch cables, a combination of patching and splicing, or in-rack splicing. All of the enclosures are equipped with universal 19" or 23" rack mounting brackets. The product line supports from 2 to 24 termination panels in a variety of standard RU enclosures. Termination Shelves (TS) are designed with a slide out master panel shelf and allows for storage of splice trays behind the master termination panel. The Patch Splice (PS) enclosures have two separate slide out shelves: One with a termination master panel; the other with a tray support bracket and hinged trays. Swing out (SO) enclosures are designed for narrow depth applications with a hinged swing out master panel and splice tray storage.

Features & Benefits

- Steel and aluminum with a polyester powder coat finish in either standard Black or Off White
- Universal mounting with reversible 19" or 23" mounting brackets
- Swing out or Slide out master termination and splice tray panels
- Patching and splicing capabilities
- Removable front and rear doors for maximum access
- Improved access to network terminations or splices
- Flexibility in rack space with a variety of solutions
- Complete family of low, medium and high capacity distribution
- Available with pre-terminated cabling or pigtails

Multilink in-rack mounted termination enclosures are designed to provide connectivity and distribution solutions. Enclosures are supplied with universal mounting hardware for 19" or 23" mounting. Slide out and swing out master panel style enclosures are designed to support the storage of splice trays. Each enclosure can be ordered fully terminated with cabling or pigtails from the factory, saving valuable installation time and in-field labor expenses. Products with your customized logo are available for OEM or other applications. Units are available in standard Black or Off White.

Swing-Out Style Fiber Distribution Units



FRM-1RU-2X-SO

12

Stock ID	10-4323 (Black) 10-4325 (Off White)
Description	Rack Mount FDU 1RU in height with 2 termination panel capacity and swing out master panel tray
Dimensions	1.75" H x 17" W x 11.0" D
Weight	12 lbs.
Material	16 GA Powder Coated Steel
Capacity	(2) Panels
Splice Tray	(2) 1120-SSTA or 1120-SSTP



FRM-2RU-4X-SO

13

Stock ID	10-4327 (Black) 10-4326 (Off White)
Description	Rack Mount FDU 2RU in height with 4 termination panel capacity and swing out master panel tray
Dimensions	3.5" H x 17" W x 11.0" D
Weight	13 lbs.
Material	16 GA Powder Coated Steel
Capacity	(4) Panels
Splice Tray	(4) 1120-SSTA or 1120-SSTP

*Adapter Panels Not Included In Units

Specifications subject to change without notice.

© Multilink, Inc. 2013 • All Rights Reserved

Slide-Out Style Fiber Distribution Units



FRM-2RU-4X-TS

14

Stock ID	10-4457 (Black - Steel) 10-4533 (Black - Aluminum) 10-4453 (Off White - Aluminum)
Description	Rack Mount FDU 2RU in height with 4 termination panel capacity and slide out master panel tray
Dimensions	3.5" H x 17" W x 14.0" D
Finish	Polyester Powder Coated
Weight	<i>Steel</i> - 22 lbs. <i>Aluminum</i> - 12 lbs.
Capacity	(4) Panels
Splice Tray	(2) 2000-SSTA



FRM-3RU-6X-TS

15

Stock ID	10-4538 (Black - Steel) 10-4540 (Black - Aluminum) 10-4455 (Off White - Aluminum)
Description	Rack Mount FDU 3RU in height with 6 termination panel capacity and slide out master panel tray
Dimensions	5.25" H x 17" W x 14.0" D
Finish	Polyester Powder Coated
Weight	<i>Steel</i> - 24 lbs. <i>Aluminum</i> - 13 lbs.
Capacity	(6) Panels
Splice Tray	(3) 2000-SSTA



FRM-4RU-12X-TS

16

Stock ID	10-4534 (Black - Steel) 10-4536 (Black - Aluminum) 10-4456 (Off White - Aluminum)
Description	Rack Mount FDU 4RU in height with 12 termination panel capacity and slide out master panel tray
Dimensions	7.0" H x 17" W x 14.0" D
Finish	Polyester Powder Coated
Weight	<i>Steel</i> - 26 lbs. <i>Aluminum</i> - 14 lbs.
Capacity	(12) Panels
Splice Tray	(8) 2000-SSTA

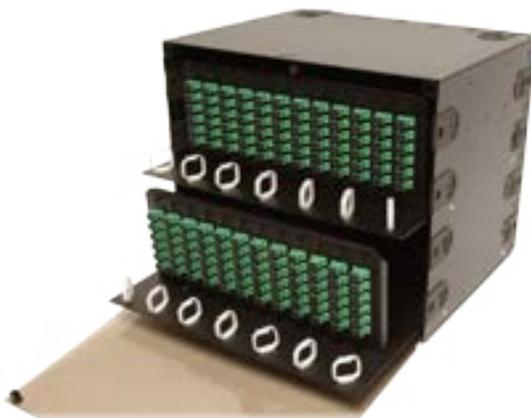

FRM-8RU-24X-TS

17

Stock ID	10-4546 (Black) 10-4545 (Off White)
Description	Rack Mount FDU 8.5RU in height with 24 termination panel capacity and dual slide out master panel trays
Dimensions	14.88" H x 17" W x 14.0" D
Weight	19 lbs.
Material	060" Powder Coated Aluminum
Capacity	(24) Panels
Splice Tray	(16) 2000-SSTA (8 trays on each Slide out Master Panel Tray)

*Adapter Panels Not Included In Units

High Density Fiber Distribution Units



FRM-1RU-3X-TS-HD

39

Stock ID	045-339-10 (Black) 045-339-11 (Off White)
Description	High Density Rack Mount FDU 1RU with split top design and locking slide out master panel tray
Dimensions	1.75" H x 17" W x 16" D
Weight	17 lbs.
Material	.060" Powder Coated Steel
Capacity	(3) Panels
Splice Tray	(2) 4072-SSTP



FRM-2RU-6X-TS-HD

40

Stock ID	045-382-10 (Black) 045-382-11 (Off White)
Description	High Density Rack Mount FDU 2RU with split top design and locking slide out master panel tray
Dimensions	3.5" H x 17" W x 16" D
Material	Powder Coated Aluminum
Capacity	(6) Panels
Splice Tray	(4) 4072-SSTP



FRM-3RU-9X-TS-HD

41

Stock ID	045-418-10 (Black) 045-418-11 (Off White)
Description	High Density Rack Mount FDU 3RU with split top design and locking slide out master panel tray
Dimensions	5.25" H x 17" W x 16" D
Material	Powder Coated Aluminum
Capacity	(9) Panels
Splice Tray	(6) 4072-SSTP



FRM-4RU-12X-TS-HD

42

Stock ID	045-391-10 (Black) 045-391-11 (Off White)
Description	High Density Rack Mount FDU 4RU with split top design and locking slide out master panel tray
Dimensions	7" H x 17" W x 16" D
Material	Powder Coated Aluminum
Capacity	(12) Panels
Splice Tray	(8) 4072-SSTP

High Density Fiber Distribution Units

Features & Benefits

- 72 Fiber capacity in 1 Rack Unit
- Convenient split-top design
- Durable powder coat finish available in black or off white
- Patching and splicing capabilities
- Locking master panel
- Increased fiber management
- Available pre-terminated

This rack mounted fiber distribution unit provides high density fiber capacity of up to 72 fibers when utilizing the adapter panels shown and two of our 4072-SSTP splice trays (not included). The slide out master panel tray locks into the retracted and fully extended positions. The split top design allows for easy termination access while bridge lances that run along the front of the unit provide easy tie down ability for fiber management entering or exiting the unit.



Featured Product

FRM-1RU-3X-TS-HD

Stock ID: 045-339-10



FRM-8RU-24X-TS-HD

44

Stock ID	045-583-10 (Black) 045-583-11 (Off White)
Description	High Density Rack Mount FDU 8RU in height with split top design and slide out master panel tray
Dimensions	13.88" H x 17" W x 16" D
Material	Powder Coated Aluminum
Capacity	(24) Panels
Splice Tray	(16) 4072-SSTP

Slide-Out Removable Top Style Fiber Distribution Units



FRM-1RU-3X-TS-S

54

Stock ID	045-686-10 (Black) 045-686-11 (Off White)
Description	Rack Mount FDU 1RU in height with split top design and slide out master panel tray
Dimensions	1.75" H x 17" W x 14.6" D
Weight	15 lbs.
Material	.060" Powder Coated Steel
Capacity	(3) Panels
Splice Tray	(3) 1120-SSTP

Product Updated



FRM-2RU-6X-TS-S

55

Stock ID	045-798-10 (Black) 045-798-11 (Off White)
Description	Rack Mount FDU 2RU in height with 6 termination panel capacity and slide out master panel tray
Dimensions	3.50" H x 17" W x 14.6" D
Weight	19 lbs.
Material	.060" Powder Coated Steel
Capacity	(6) Panels
Splice Tray	(3) 2000-SSTA

Product Updated



FRM-3RU-9X-TS-S

56

Stock ID	045-799-10 (Black) 045-799-11 (Off White)
Description	Rack Mount FDU 3RU in height with 9 termination panel capacity and slide out master panel tray
Dimensions	5.2" H x 17" W x 14.6" D
Weight	20.5 lbs.
Material	.060" Powder Coated Steel
Capacity	(9) Panels
Splice Tray	(5) 2000-SSTA

Product Updated



FRM-4RU-12X-TS-S

57

Stock ID	045-800-10 (Black) 045-800-11 (Off White)
Description	Rack Mount FDU 4RU in height with 12 termination panel capacity and slide out master panel tray
Dimensions	6.96" H x 17" W x 14.6" D
Weight	26 lbs.
Material	.060" Powder Coated Steel
Capacity	(12) Panels
Splice Tray	(8) 2000-SSTA

Product Updated

*Adapter Panels Not Included In Units

Specifications subject to change without notice.

© Multilink, Inc. 2013 • All Rights Reserved



Signature Series Fiber Distribution Units

The Multilink Signature Series panel offers a solution in which you can adapt the unit to any adapter panel or module footprint you want in a way that has never been offered before. The newest Multilink patch panel series is engineered to allow adaptation to a wide variety of patching applications as well as module installations. We can now adjust to any of these scenarios with just a simple swap of the bulkhead bracket. The unique master panel design allows for easy and secure routing of fiber without obstructions or compromising your bend radius.



FRM-1RU-XX-SIG

Stock ID	045-665-00 (Black)
Description	Signature Series Rack Mount FDU 1RU in height with slide tray and no bulkhead
Dimensions	1.75" H x 19" W x 14.19" D
Material	Aluminum & Steel
Capacity	See bulkhead options
Splice Tray	Splicing available with modules and cassettes only



FRM-4RU-XX-SIG

Stock ID	045-763-00 (Black)
Description	Signature Series Rack Mount FDU 4RU in height with slide tray and no bulkhead
Dimensions	7" H x 19" W x 14.2" D
Material	Aluminum & Steel
Capacity	See bulkhead options
Splice Tray	Splicing available with modules and cassettes only



Bulkhead-Standard Multilink Panels

Stock ID	072-208-20 (1RU) 072-277-20 (4RU)
Description	Signature Series bulkhead for standard Multilink adapter panels/modules
Capacity	(3) Panels per rack unit



Bulkhead-Multilink CT-X Modules

Stock ID	072-208-50 (1RU) 072-277-50 (4RU)
Description	Signature Series bulkhead for Multilink CT-X Modules
Capacity	(2) Modules per rack unit



Bulkhead-Narrow Multilink Modules

Stock ID	072-208-30 (1RU) 072-277-30 (4RU)
Description	Signature Series bulkhead for Multilink Narrow FTM Modules
Capacity	(4) Modules per rack unit

Note: Both a bulkhead and a main panel must be ordered separately to have a complete unit. All bulkheads are interchangeable, with no other changes to the tray or body except relocating the stop plungers. Multilink standard one year manufacturing warranty applies. Contact us for a copy of our full warranty details.

Slide-Out Style Combination Patch & Splice Distribution Units



FRM-4RU-4X-PS (Includes 1 4048 splice tray)

18

Stock ID	10-5270 (Black) 10-2146 (Off White)
Description	Rack Mount FDU 4RU in height with slide out master panel with 4 termination capacity and separate splice out splice tray panel
Dimensions	7.0" H x 17" W x 14.0" D
Weight	16 lbs.
Material	.060" Powder Coated Aluminum
Capacity	(4) Panels
Splice Tray	(4) 4048-SSTP or (4) 4072-SSTP

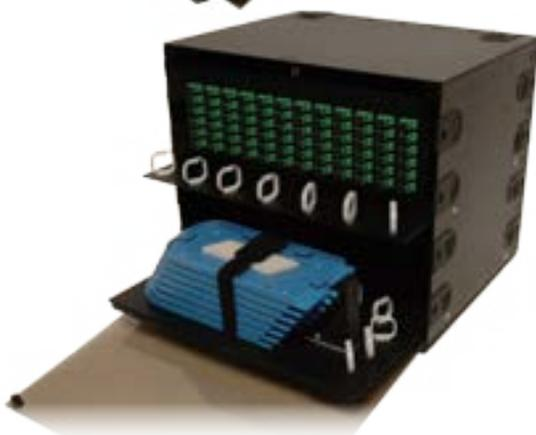

FRM-8RU-12X-PS (Includes 1 4048 splice tray)

19

Stock ID	10-8584 (Black) 10-8585 (Off White)
Description	Rack Mount FDU 8.5RU in height with slide out master panel with 12 termination capacity and separate splice out splice tray panel
Dimensions	14.88" H x 17" W x 14.0" D
Weight	20 lbs.
Material	.060" Powder Coated Aluminum
Capacity	(12) Panels
Splice Tray	(8) 4048-SSTP or (8) 4072-SSTP

Slide-Out Style Splice Shelves



FRM-3RU-SS

Stock ID	045-782-10 (Black) 045-783-10 (Off White)
Description	Rack Mount 3RU in height slide out master splice tray support panel
Dimensions	5.25" H x 17" W x 14.0" D
Weight	7.25 lbs.
Material	.060" Powder Coated Aluminum
Capacity	(4) 24 Fiber Splice Trays
Splice Tray	(4) 4048-SSTP or (4) 4072-SSTP



FRM-4RU-SS

Stock ID	045-785-10 (Black) 045-784-10 (Off White)
Description	Rack Mount 4RU in height slide out master splice tray support panel
Dimensions	7.0" H x 17" W x 14.0" D
Weight	8.35 lbs.
Material	.060" Powder Coated Aluminum
Capacity	(8) 24 Fiber Splice Trays
Splice Tray	(8) 4048-SSTP or (8) 4072-SSTP

*Splice Trays Not Included In Units

Slide-Out Style Splice Shelves

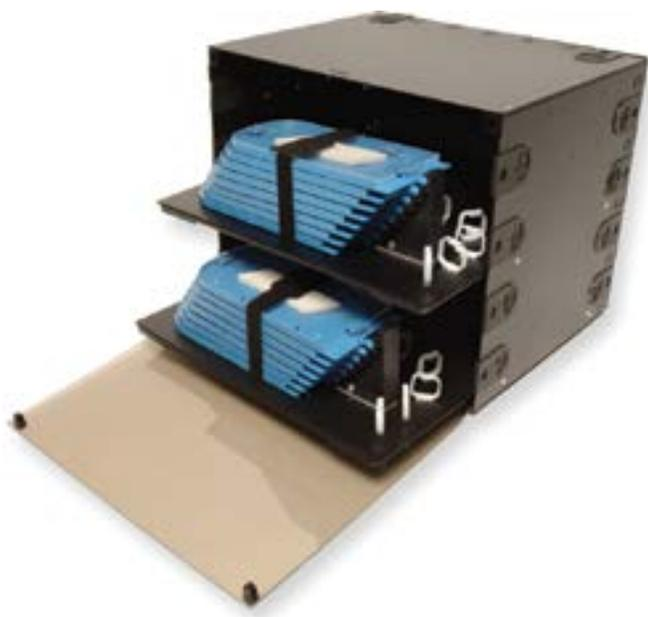

FRM-8RU-SS

Stock ID	045-786-10 (Black) 045-787-10 (Off White)
Description	Rack Mount 8.5RU in height slide out master splice tray support panel
Dimensions	14.88" H x 17" W x 14.0" D
Weight	13.75 lbs.
Material	.060" Powder Coated Aluminum
Capacity	(16) 24 Fiber Splice Trays (8 on each shelf)
Splice Tray	(16) 4048-SSTP or (16) 4072-SSTP

In-Rack Patch Enclosure Solutions



FF-RM-12X

20

Stock ID	10-1038 (Black) 10-6450 (Off White)
Description	Rack Mount 4RU in height fixed master panel with integrated horizontal and vertical jumper guides
Dimensions	7.0" H x 17" W x 14.0" D
Weight	9.5 lbs.
Material	.060" Powder Coated Aluminum
Capacity	(12) Panels



Main unit is offset 15/16" from front of brackets

FRM-1RU-2X-TS-DOT

46

Stock ID	045-586-10 (Black) 045-586-30 (Black w/Slide Tray) ⁵²
Description	Rack Mount 1RU in height made for a 19" or 23" rack width. Features slide-off cover, 2 fixed bulkhead positions, and 2 captive grommets for cable entry.
Dimensions	1.72" H x 12.25" W x 7.68" D (excluding brackets)
Weight	5.1 lbs.
Material	Powder Coated Steel
Capacity	(2) Panels (1) 612-SSTP Splice Tray

*Adapter Panels Not Included In Units

Optional Rack Mount Equipment



Sliding Drawer Shelves

Stock ID	1RU - 045-372-10 2RU - 045-163-10
Description	19" Rack Mount Drawer
Dimensions	1RU - 1.75" H x 19" W x 16.02" D 2RU - 3.65" H x 19" W x 16.02" D
Material	Powder Coated Steel
Capacity	1RU - 1.27" H x 16.25" W x 15.63" D 2RU - 3.54" H x 16.25" W x 15.63" D

The Multilink Rack Mount Sliding Drawer Shelf is available 1RU or 2RU in height and designed for 19" rack mounting only. Drawer fully extends from rack and can also be used as a shelf for a laptop or test equipment. (Includes mounting hardware)



FRM-1RU-3X Bulkhead

Stock ID	065-060-10
Description	19" Rack Mount Patch Panel 1RU w/ 10-32 & 12-24 hardware included
Material	Powder Coated Steel
Capacity	3 Adapter Panels



FRM-1RU Patch Bulkhead

Stock ID	48 SC - 072-233-10 36 SC - 072-238-10 24 LC - 072-235-10
Description	19" Rack Mount Patch Panel 1RU w/ 10-32 hardware included
Material	Powder Coated Steel



FRM-1RU-3X Bulkhead w/ Shelf

Stock ID	072-035-10
Description	19" Rack Mount Bulkhead with Shelf for Slack Storage w/ 10-32 & 12-24 hardware included
Dimensions	1.75" H x 19" W x 8" D
Material	Powder Coated Steel
Capacity	3 Adapter Panels



FRM-1RU Shelf

Stock ID	072-043-10
Description	19" Rack Mount Shelf 1RU
Dimensions	1.75" H x 19" W x 12" D
Material	Powder Coated Steel
Capacity	30 lbs.



FRM-RU Filler Panels

Stock ID	1RU - 072-046-10 2RU - 072-046-20 3RU - 072-046-30 4RU - 072-046-40
Description	19" Rack Mount Filler Panels
Material	Powder Coated Steel

Rack Enclosure Accessories



Lock & Key for Rack Mount Enclosures

Stock ID	99534
Description	Lock and Key for Lexan Doors of Rack Mount Enclosures

Ask for 99534 to be installed on your rack mount enclosure



Strain Relief Kit (1RU)

Stock ID	065-249-10
Description	Strain Relief Bracket for 1RU Rack Mount Enclosures with bracket and tie straps
Material	Powder coated steel, plastic straps



Strain Relief Kit (2RU or larger)

Stock ID	065-151-10
Description	Strain Relief Bracket for Rack Mount Enclosures
Diameter	Ø.300 - .790"
Material	Powder coated steel, rubber grommets
Grommets	(1) Ø .300 - .400", (1) Ø .410 - .500", (1) Ø .510 - .790"



Indoor Network Switch Enclosure

Stock ID	050-051-20
Description	Wall Mounted Indoor Network Switch Enclosure for 19" Rack Equipment w/Duplex Outlet and Thermostatically Controlled 100CFM Fan
Dimensions	24" H x 27.6" W x 8.4" D
Material	Powder Coated Steel
Capacity	3 Rack Units

Multilink's Family of Wall Mount Enclosures



The Multilink family of wall mounted optical termination enclosures are designed to provide solutions for both the interconnection of patch cabling and a combination of patching and splicing. The family accommodates from a single termination panel up to 16 termination panels. Depending on the type of optical termination panel used, enclosures can support up to 192 terminations. The family of enclosures is separated into several application specific groups to support the level of termination capacity and feature sets required for the enclosures mount location.

Features & Benefits

- Durable Steel or Aluminum with a polyester powder coat finish in either standard Black or Off White.
- Several units are designed with additional means of security but maintaining ease in access for craft personnel.
- Individual compartments for separation of network and distribution terminations.
- Wide range of sizes and feature sets to accommodate specific application requirements.
- Easy to install, load, and maintain.
- Available with loaded termination panels and pre-connectorized pigtails.
- Durable construction.

Standard Single Outer Door Fiber Distribution Units

Multilink wall mount enclosures are designed to provide connectivity and distribution solutions. Enclosures are divided into several groups to meet application specific requirements such as Construction Grade, Single Door, Dual Door, Added Security, NEMA 4 and NEMA 12. Products with your customized logo are available for OEM or other applications. Units are available in standard Black or Off White unless specified.

MultiLite Construction Grade Fiber Distribution Units



WM-2X

26

Stock ID	10-7944 Black Only
Description	Wall mount single outer door construction grade distribution unit with 2 termination panel capacity
Dimensions	9.25" H x 13" W x 3.5" D
Box Weight	7 lbs.
Material	18 GA Powder Coated Steel
Capacity	(2) Panels
Splice Tray	(2) 1120-SSTP



WM-4X

27

Stock ID	10-7945 Black Only
Description	Wall mount single outer door construction grade distribution unit with 4 termination panel capacity
Dimensions	11.5" H x 13" W x 3.5" D
Box Weight	8 lbs.
Material	18 GA Powder Coated Steel
Capacity	(4) Panels
Splice Tray	(4) 1120-SSTP



WM-8X

28

Stock ID	10-7790 Black Only
Description	Wall mount single outer door construction grade distribution unit with inner network compartment security door and 8 termination panel capacity
Dimensions	12" H x 17" W x 6" D
Box Weight	15 lbs.
Material	18 GA Powder Coated Steel
Capacity	(8) Panels
Splice Tray	(8) 1120-SSTP

*Adapter Panels Not Included In Units

Specifications subject to change without notice.

© Multilink, Inc. 2013 • All Rights Reserved

Standard Single Outer Door Fiber Distribution Units



FWM-1X

32

Stock ID	045-164-10 / FWM-1X-BK, Black 045-164-11 / FWM-1X-OW, Off White
Description	Compact indoor wall mount enclosure for inter connectivity and termination of optical fibers
Panels	(1) Multilink Adapter Panels (see individual panel capacities)
Dimensions	6.30" H x 5.50" W x 1.57" D
Fiber Capacity	(1) Fiber Spool
Material	18 Gauge Steel
Coating	Electrostatic polyester powder coat paint, available in Black & Off White



FWM-1X-SP

33

Stock ID	045-187-10 / FWM-1X-SP-BK, Black 045-187-11 / FWM-1X-SP-OW, Off White
Description	Compact indoor wall mount enclosure for inter connectivity and termination of optical fibers
Panels	(1) Multilink Adapter Panels (see individual panel capacities)
Dimensions	6.30" H x 5.50" W x 1.57" D
Fiber Capacity	(12) Single Splice Holder
Material	18 Gauge Steel
Coating	Electrostatic polyester powder coat paint, available in Black & Off White

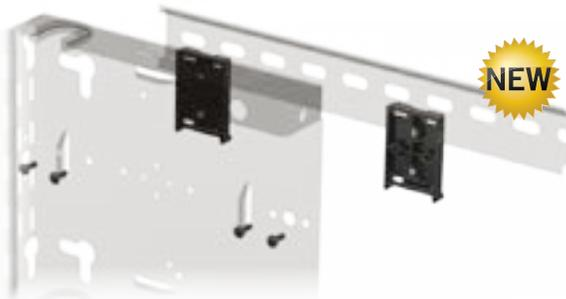

NEW

Din Rail Mounting Kit

Stock ID	072-188-20 (Black)
Description	Din rail mounting kit (compatible w/ FWM-1X)



FWM-2X-PH

35

Stock ID	045-178-10 (Black) 045-178-11 (Off White)
Description	Compact indoor wall mount enclosure for inter connectivity and termination of optical fiber
Dimensions	10" H x 8.22" W x 3.81" D
Material	16 GA Gauge Steel
Capacity	(2) Multilink Adapter Panels
Splice Tray	(2) 1120-SSTP

*Adapter Panels And Fiber Are Not Included In Units

Standard Lockable Fiber Distribution Units



FWM-2X-LC

01

Stock ID	10-2012 (Black) 10-2730 (Off White)
Description	Wall mount single outer door distribution unit with inner network compartment security door and 2 termination panel capacity
Dimensions	10.2" H x 12" W x 3.5" D
Box Weight	8 lbs.
Material	18 GA Powder Coated Steel
Capacity	(2) Panels
Splice Tray	(2) 1120-SSTP



FWM-4X-LC

02

Stock ID	10-1914 (Black) 10-2714 (Off White)
Description	Wall mount single outer door distribution unit with inner network compartment security door and 4 termination panel capacity
Dimensions	12" H x 12" W x 3.5" D
Box Weight	9 lbs.
Material	18 GA Powder Coated Steel
Capacity	(4) Panels
Splice Tray	(4) 1120-SSTP



FWM-4X-D

08

Stock ID	99024BK (Black) 99024K (Off White)
Description	Wall mount dual outer door distribution unit with lockable network compartment door and 4 termination panel capacity
Dimensions	10.8" H x 12" W x 4" D
Box Weight	10 lbs.
Material	16 GA Powder Coated Steel
Capacity	(4) Panels
Splice Tray	(4) 1120-SSTP



FWM-9X-D

09

Stock ID	10-5283 (Black) 10-5281 (Off White)
Description	Wall mount dual outer door distribution unit with lockable network and distribution compartment doors and 9 termination panel capacity
Dimensions	17" H x 21.2" W x 5" D
Box Weight	23 lbs.
Material	16 GA Powder Coated Steel
Capacity	(9) Panels
Splice Tray	(3) 2000-SSTA

*Adapter Panels Not Included In Units

Specifications subject to change without notice.

© Multilink, Inc. 2013 • All Rights Reserved

Splice Tray Management & Storage Units



FWE-288-XH

Stock ID	045-063-10 (Black Only)
Description	Economy 288 port wall mount unit, double door
Dimensions	17" H x 21.2" W x 5" D
Box Weight	23 LBS.
Material	16 Gauge Steel
Capacity	(12) splice trays, single fusion, ribbon, or mechanical
Splice Tray	(12) 2000-SSTA or 2020-SSTP



FWE-288-XH (Single door)

Stock ID	045-771-10 (Black Only)
Description	Economy 288 port wall mount unit
Dimensions	17.3" H x 22.5" W x 5" D
Box Weight	23 LBS.
Material	16 Gauge Steel
Capacity	(12) splice trays, single fusion, ribbon, or mechanical
Splice Tray	(12) 2000-SSTA or 2020-SSTP



FWM-0X-N1-3

Stock ID	045-139-10 (Beige Only)
Description	Wall mount splice tray storage and distribution unit with padlockable and removable outer door. 3 Splice trays included.
Dimensions	17.5" H x 9" W x 4" D
Material	16 GA Powder Coated Steel
Capacity	(3) Splice Trays
Splice Tray	1120-SSTP



FWM-8184

Stock ID	045-706-10 (Beige Only w/ 1 4048 Splice Tray)
Description	Wall mount splice tray storage and distribution unit with screw-down, removable outer door.
Dimensions	19.15" H x 8.25" W x 4" D (excluding mounting bracket)
Material	16 GA Powder Coated Steel
Capacity	(4) Splice Trays
Splice Tray	(4) 4048-SSTP

FWM-8204

Stock ID	045-751-10 (Beige Only w/ 4 4072 Splice Trays)
Description	Wall mount splice tray storage and distribution unit with screw-down, removable outer door.
Dimensions	21.15" H x 8.25" W x 4" D (excluding mounting bracket)
Material	16 GA Powder Coated Steel
Capacity	(4) Splice Trays
Splice Tray	(4) 4072-SSTP

*Splice Trays And Fiber Not Included In Units

Splice Tray Management & Storage Units



OSE 384/576

Stock ID	045-009-10 / OSE 384/576 Black 045-009-11 / OSE 384/576 Off White
Description	Wall mounted central splicing and cable management enclosure
Dimensions	32" H x 30" W x 15.25" D
Box Weight	47 lbs.
Material	.080" Aluminum
Capacity	(16) Splice Trays
Splice Tray	(16) 4048-SSTP or (16) 4072 SSTP
Cable-Addition Kit	065-016-10 (See page 25)

Added Security Dual Door Fiber Distribution Units



FF-WM-2X

05

Stock ID	10-4469 (Black) 10-6707 (Off White)
Description	Compact wall mount dual outer door distribution unit with 2 termination panel capacity and integrated network compartment and removable style locking door
Dimensions	6" H x 12" W x 5.5" D
Box Weight	8 lbs.
Material	16 GA Powder Coated Steel
Capacity	(2) Panels
Splice Tray	(2) 1120-SSTP



FF-WM-4X

06

Stock ID	10-4462 (Black) 10-6706 (Off White)
Description	Compact wall mount dual outer door distribution unit with 4 termination panel capacity and integrated network compartment work shelf and removable style locking door
Dimensions	12" H x 14.3" W x 4.9" D
Box Weight	12 lbs.
Material	16 GA Powder Coated Steel
Capacity	(4) Panels
Splice Tray	(2) 1120-SSTP



FF-WM-8X

29

Stock ID	045-030-10 (Black) 045-030-11 (Off White)
Description	Compact wall mount dual outer door distribution unit with 8 termination panel capacity and integrated network compartment work shelf and removable style locking door
Dimensions	16" H x 20" W x 6.5" D
Box Weight	24 lbs.
Material	16 GA Powder Coated Steel
Capacity	(8) Panels
Splice Tray	(4) 2000-SSTA

*Adapter Panels Not Included In Units

Outdoor Style Fiber Distribution Units



FWM-2X-N1 (with termination panel)
FWM-0X-N1 (without termination panel)
ICM-2X (optional termination panel)

22

Stock ID	10-4870 - FWM-2X-N1 (Beige Only) 10-9867 - FWM-0X-N1 (Beige Only) 10-7812 - ICM-2X
Description	Wall mount distribution unit with lockable and removable single outer door. Available as a 2 panel termination and splice or splice only unit
Dimensions	17.5" H x 9" W x 4" D
Material	16 GA Powder Coated Steel
Capacity	(2) Panels
Splice Tray	(2) 1120-SSTP (4 trays if no termination panel unit used)
Compliances	NEMA Type 1



FWM-2X-N4D

23

Stock ID	045-060-10 (Beige Only)
Description	Wall mount single outer door distribution unit with lockable network compartment door and 2 termination panel capacity
Dimensions	14" H x 15" W x 8.1" D
Material	.08" Powder Coated Aluminum
Capacity	(2) Panels
Splice Tray	(2) 1120-SSTP
Compliances	NEMA Type 1, 4 <i>(Mounting kit required for NEMA 4 compliance)</i>
Mounting Kit	072-105-11
Pole Kit	072-060-10



FWM-4X-N4D

24

Stock ID	045-080-10 (Beige Only)
Description	Wall mount single outer door distribution unit with lockable network compartment door and 4 termination panel capacity
Dimensions	16" H x 17" W x 9.1" D
Material	.08" Powder Coated Aluminum
Capacity	(4) Panels
Splice Tray	(4) 2000-SSTA (4) 1120-SSTP
Compliances	NEMA Type 1, 4 <i>(Mounting kit required for NEMA 4 compliance)</i>
Mounting Kit	072-105-11
Pole Kit	072-051-10



FWM-12X-N4D

25

Stock ID	045-042-10 (Beige Only)
Description	Wall mount single outer door distribution unit with lockable network compartment door and 12 termination panel capacity
Dimensions	20" H x 21.2" W x 11.3" D
Material	.08" Powder Coated Aluminum
Capacity	(12) Panels
Splice Tray	(6) 3000-SSTA
Compliances	NEMA 1, 4 <i>(Mounting kit required for NEMA 4 compliance)</i>
Mounting Kit	072-105-11
Pole Kit	072-061-10

*Adapter Panels, Fiber, and Splice Trays Not Included In Units

Outdoor Style Fiber Distribution Units



FF-OCS-4X

53

Stock ID	045-741-10 (Gray Only)
Description	Wall mounted NEMA 1, 2, 3, 4, 4X, 12, and 13 rated enclosure with a single outer door and inner network security door. 4 Panel termination capacity and field drilled cable entries using standard weather tight conduit fittings.
Dimensions	15.84" H x 13.85" W x 6.79" D
Weight	10 lbs.
Material	Impact and Weather Resistant Plastic
Capacity	(4) Panels
Splice Tray	(4) 1120-SSTP
Options	NPT Cable Entrance Kit (065-016-10)



FF-OCS-6X

11

Stock ID	10-3338 (Gray Only)
Description	Wall mounted NEMA 1, 2, 3S, 4, 4X, 12 & 13 rated enclosure with a single outer door and inner network security door. 6 Panel termination capacity and field drilled cable entries using standard weather tight conduit fittings.
Dimensions	Outside - 18" H x 16" W x 10" D Inside - 16" H x 14" W x 7" D
Weight	10 lbs.
Material	Impact and Weather Resistant Plastic
Capacity	(6) Panels
Splice Tray	(4) 1120-SSTP or 3000-SSTA
Options	NPT Cable Entrance Kit (065-016-10)

Lockable Draw-Latch



Cable Addition Kit

Stock ID	065-016-10
Description	Cable Addition Kit for Branch or Lateral Cable Additions, .3"-.98"
UOM	Each

Grommet Inserts For 1" NPT Fittings

Stock ID	10-5552	10-5127	10-5128	10-6550	10-5129	10-6552	10-6002	10-5130	10-5134	065-082-10
10 Pack ID	10-5553	10-5421	10-5422	10-6551	10-5419	10-6553	10-6003	10-5483	10-5420	N/A
# of Ports	1	1	1	8	6	4	4	4	4	1-SC
Cable Size	.3"-.4"	.41"-.5"	.51"-.79"	.150"	.265"	.300"	.350"	.370"	Flat Drop	SC Outdoor
Weight	.5 lbs.	.5 lbs.	.5 lbs.	.5 lbs.	.5 lbs.	.5 lbs.	.5 lbs.	.5 lbs.	.5 lbs.	.2 lbs.

Plastic Fiber Distribution Units



RNI-1500 w/ Fiber Distribution Configuration

Stock ID	020-098-10
Description	Indoor/Outdoor Plastic Wall Enclosure RNI-1500
Dimensions	12.27" W x 11.88" H x 4.86" D
Capacity	(2) Adapter Panels and (2) 612 Splice Trays
Material	UV Stabilized Plastic, Gray (can be painted with latex paint)
Cable Entry	Multiple Entry Points at Bottom of Enclosure

FWP-16SC-24SP

50

Stock ID	020-120-20
Description	Wall mount distribution box with flip-up patch panel, and fixed splice tray below
Dimensions	12" H x 10.25" W x 3.75" D
Material	Plastic
Capacity	(16) SC Connections (24) Splices

Featured Product



RNI-2500

Stock ID: 020-104-50

*Adapter Panels, Fiber, and Splice Trays Not Included In Units

Plastic Fiber Distribution Units

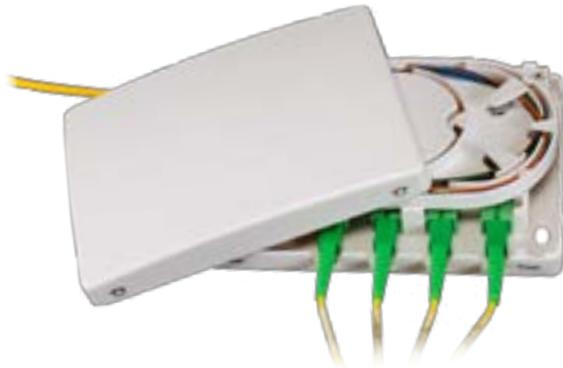

FWP-4SC-4SP

49

Stock ID	020-124-20
Description	Wall mounted, plastic distribution unit with removable cover and swing out slack tray.
Dimensions	4.3" H x 6" W x 1.2" D
Material	Plastic
Capacity	(4) SC Connections (4) Splices

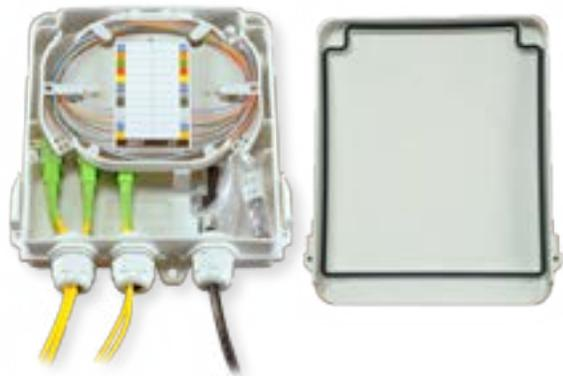

FWP-8SC-12SP

51

Stock ID	020-118-20
Description	Wall mounted, plastic distribution unit with removable cover and swing out splice panel.
Dimensions	8.3" H x 6.9" W x 2" D
Material	Plastic
Capacity	(8) SC Connections (12) Splices



FWP-2SC-2SP

Stock ID	065-773-10
Description	Wall mounted, plastic distribution unit with removable cover, SC duplex adapter holder, and splice holder.
Dimensions	3" H x 6" W x .625" D
Material	Plastic
Capacity	(2) SC Connections (2) Splices



RNI-2500 w/ Fiber Distribution Configuration

Stock ID	020-104-50
Description	Indoor/Outdoor Plastic Wall Enclosure RNI-2500
Dimensions	12.95" H x 12.37" W x 4.9" D
Capacity	(2) Adapter Panels and (2) 612 Splice Trays
Material	UV Stabilized Plastic, Gray (can be painted with latex paint)
Cable Entry	Multiple Non-Captive Entry Points at Bottom of Enclosure

*Adapter Panels, Fiber, and Splice Trays Not Included In Units

Splice Trays

All of the Multilink splice trays are universal to the industry. These trays are compatible with all of our enclosures. The splice trays provide protection and organization of fiber splices. Adhesive backed fiber insert holders and assorted cable ties included (grommets included on the 3030-SSTP).



2000-SSTA

X2

Stock ID	70506K
Model #	2000-SSTA
Description	24 Single Fusion Splice Tray
Dimensions	11.75" L x 4" W x .5" D
Weight	Approx. 0.65 lbs.
Material	Aluminum
Capacity	24 Single Fusion Splices, 16 Mechanical Splices, or 96 Mass Fusion Splices



3000-SSTA

X6

Stock ID	70505K
Model #	3000-SSTA
Description	24 Single Fusion Splice Tray
Dimensions	7.75" L x 6" W x .5" D
Weight	Approx. 0.54 lbs.
Material	Aluminum
Capacity	24 Single Fusion Splices, 16 Mechanical Splices, or 96 Mass Fusion Splices



2020-SSTP

X3

Stock ID	70709K
Model #	2020-SSTP
Description	24 Single Fusion Splice Tray
Dimensions	12.25" L x 4" W x .5" D
Weight	Approx. 0.54 lbs.
Material	Plastic Base w/ Aluminum Cover
Capacity	24 Single Fusion Splices, 16 Mechanical Splices, or 96 Mass Fusion Splices

Splice Trays

All of the Multilink splice trays are universal to the industry. These trays are compatible with all of our enclosures. The splice trays provide protection and organization of fiber splices. Adhesive backed fiber insert holders and assorted cable ties included (grommets included on the 3030-SSTP).



612-SSTP

X8

Stock ID	065-209-10
Model #	612-SSTP
Description	12 Single Fusion Splice Tray
Dimensions	6" L x 2.75" W x .75" D
Weight	Approx. 0.10 lbs.
Material	Plastic
Capacity	12 Single Fusion Splices Only 40mm Splice Sleeve Only



1120-SSTP

X9

Stock ID	072-059-10
Model #	1120-SSTP
Description	12 Single Fusion Splice Tray
Dimensions	6.5" L x 5.13" W x 0.5" D
Weight	Approx. 0.20 lbs.
Material	Plastic
Capacity	12 Single Fusion Splices Only 40mm Splice Sleeve Only

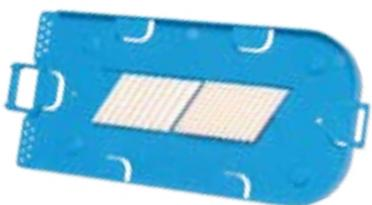

4048-SSTP

X4

Stock ID	10-8007
Model #	4048-SSTP
Description	24 Single Fusion Splice Tray
Dimensions	9.75" L x 4.5" W x .5" D
Weight	Approx. 0.60 lbs.
Material	Plastic
Capacity	24 Single Fusion Splices (48 Dual Stacked), 16 Mechanical Splices, or 96 Mass Fusion Splices



4072-SSTP

X5

Stock ID	065-001-10
Model #	4072-SSTP
Description	36 Single Fusion Splice Tray
Dimensions	10.75" L x 5.75" W x .5" D
Weight	Approx. 0.60 lbs.
Material	Plastic
Capacity	36 Single Fusion Splices (72 Dual Stacked), 24 Mechanical Splices, or 144 Mass Fusion Splices



3030-SSTP

X7

Stock ID	70706K
Model #	3030-SSTP
Description	24 Single Fusion Splice Tray
Dimensions	8.25" L x 5.75" W x .5" D
Weight	Approx. 0.50 lbs.
Material	Plastic
Capacity	24 Single Fusion Splices, 16 Mechanical Splices, or 96 Mass Fusion Splices

Fiber Distribution Pedestals



An Outside Plant Pedestal designed for splicing and termination fiber optic cable. The peds split base design allows for ring cutting of the fiber optic cable for mid-span access, and termination of up to 48 drop cables utilizing SC Duplex style adaptors. The optical splitters used within this product are a fused biconic design and housed within the lower splice tray. The pedestal includes one 24 fiber splice tray, and all the hardware required to secure three cables. This design also lends itself to cross-connect applications saving the expense of a stand-alone cabinet.

Construction

Material	Base - HDPE High Density Poly Ethylene Cover - LDPE Low Density Poly Ethylene Rotomolding Frame & Termination Plate - Aluminum
Hardware	Stainless Steel
Plate Finish	Polyester Powder Coat

Cover	Removable cover slides on top of unit and is secured by hex-head bolt
Cable Entrance	Bottom Open For Concrete Pad, Or Vault Mounting
Capacity	(24-144) SC Duplex Adapters Up to 192 Single Fusion Splices

Stock ID	Description	Dimensions	UOM
020-135-20	48 SC Fiber Distribution Pedestal w/ (1) 4048-SSTP Included	31"H x 10"W x 10"D	Each
020-135-30	192 Splice-Only Fiber Distribution Pedestal w/ (1) 4048-SSTP Included	31"H x 10"W x 10"D	Each
020-137-20	144 SC Fiber Distribution Pedestal w/ (1) 4072-SSTP Included	41" L x 12" W x 12" D	Each
10-8007	4048-SSTP 24ct. Single Fusion Splice Tray	9.75" L x 4.5" W x .5" D	Each
065-001-10	4072-SSTP 36ct. Single Fusion Splice Tray	10.75" L x 5.75" W x .5" D	Each



For more information on additional sizes, pricing, and availability please contact your Customer Service Representative.

Rack and Wall Mount FDU Configurator

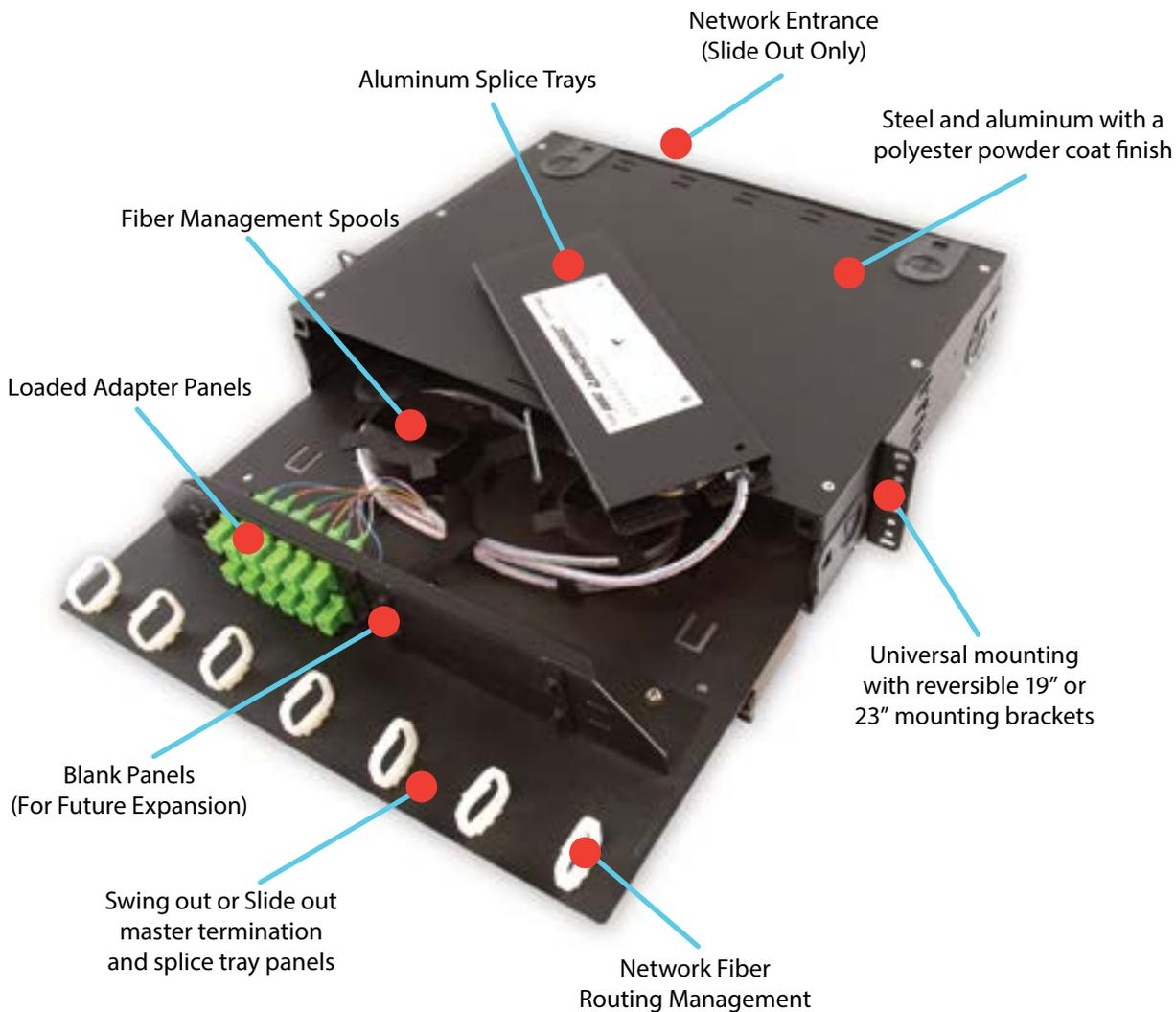

Rack and Wall Mount FDU Configurator

ML- - - - - - - - - -

ML - 02 - 24 - B - ST6 - MP - 003 - 21 - 12

Translates:

FWM-2X-LC, 24 loaded ports, Black, ST 6 Port Multimode, Multifiber pigtails, 3 meters in length, equipped with 2 of the 1120-SSTA trays

Enclosure Type	# Of Conn.	Color	Adapter	Pigtail	Length (Meters)	Splice Tray***	Splice Count
WALL MOUNTS							
01 FWM-2X-LC	006	B-Black	SCS=SC Simplex MM	00=None	00X**	X2=2000-SSTA	24
02 FWM-4X-LC	012	O-Off White	SCD=SC Duplex MM	T9=900µm (spiral wrap)		X3=2020-SSTP	24
05 FF-WM-2X	018	BE-Beige*	SUS=SC Simplex SM	T3=3mm		X4=4048-SSTP	24
06 FF-WM-4X	024	G-Gray*	SUD=SC Duplex SM	MD=Module		X5=4072-SSTP	36
08 FWM-4X-D	030		SAS=SC/APC Simplex SM	OSP=OSP Dielectric Cable		X6=3000-SSTA	24
09 FWM-9X-D	036		SAD=SC/APC Duplex SM	OSA=OSP Armored Cable		X7=3030-SSTP	24
53 FF-OCS-4X	042		SGS=SC Simplex 10Gig	RBN= Ribbon		X8=612-SSTP	12
11 FF-OCS-6X	048		SGD=SC Duplex 10Gig	DST=Distribution Cable (Riser Rated)		X9=1120-SSTP	12
22 FWM-2X-N4	054						
23 FWM-2X-N4D	060		FC=FC MM			"X" denotes number of trays	
24 FWM-4X-N4D	066		FU=FC SM				
25 FWM-12X-N4D	072		FA=FC/APC				
26 WM-2X (Multilite)	096						
27 WM-4X (Multilite)	144		LCAD=LC/APC Duplex SM				
28 WM-8X (Multilite)	288		LCAQ=LC/APC Quad SM				
29 FF-WM-8X			LCPD=LC Duplex MM				
32 FWM-1X-BK			LCPQ=LC Quad MM				
33 FWM-1X-SP-BK			LCUD=LC Duplex SM				
35 FWM-2X-PH			LCUQ=LC Quad SM				
37 RNI-1000			LCGD=LC Duplex 10 Gig				
38 RNI-1500			LCGQ=LC Quad 10 Gig				
43 RNI-1200							
45 RNI-2500			ST6=ST 6 port MM				
49 FWP-4SC-4SP			ST8=ST 8 port MM				
50 FWP-16SC-24SP			ST12=ST 12 port MM				
51 FWP-8SC-12SP			SM6=ST 6 port SM				
			SM8=ST 8 port SM				
			SM12=ST 12 port SM				
RACK MOUNTS							
12 FRM-1RU-2X-SO							
54 FRM-1RU-3X-TS-S							
39 FRM-1RU-3X-TS-HD							
46 FRM-1RU-2X-TS-DOT							
52 FRM-1RU-2X-TS-DOT-S							
13 FRM-2RU-4X-SO							
14 FRM-2RU-4X-TS							
55 FRM-2RU-6X-TS-S							
40 FRM-2RU-6X-TS-HD							
15 FRM-3RU-6X-TS							
56 FRM-3RU-9X-TS-S							
41 FRM-3RU-9X-TS-HD							
16 FRM-4RU-12X-TS							
57 FRM-4RU-12X-TS-S							
18 FRM-4RU-4X-PS							
42 FRM-4RU-12X-TS-HD							
17 FRM-8.5RU-24X-TS							
19 FRM-8.5RU-12X-PS							
44 FRM-8RU-24X-TS-HD							
20 FF-RM-12X							

* Only available for specified boxes. Refer to catalog descriptions.

** Feet divided by 2.54 and rounded up to the full meter.

*** Align with unit type.

	Stock ID	Model #	Conn. Type	# Of Conn.	Ferrule	Mode	Fiber Polish	Conn. Color	Plate Color	Plate Code
	10-5458	MST-06-P-BLK	ST	6	Phos. Bronze	MM	PC UPC	Chrome	Black	ST6
	10-5457	MST-06-P-OW							Off White	
	99234K	MST-06-C-BLK	ST	6	Ceramic	SM	Any	Chrome	Black	SM6
	99223K	MST-06-C-OW							Off White	
	10-9196	MST-12-P-BLK	ST	12	Phos. Bronze	MM	PC UPC	Chrome	Black	ST12
	10-9195	MST-12-P-OW							Off White	
	10-6065	MST-12-C-BLK	ST	12	Ceramic	SM	Any	Chrome	Black	SM12
	10-6177	MST-12-C-OW							Off White	
	10-5095	MFC-06-P-BLK	FC	6	Phos. Bronze	MM	PC UPC	Chrome	Black	FC
	10-8751	MFC-06-P-OW							Off White	
	10-4744	MFC-06-C-BLK	FC	6	Ceramic	SM	Any	Chrome	Black	FU
	99218CK	MFC-06-C-OW							Off White	
	065-218-50	MFC-12-P-BLK	FC	12	Phos. Bronze	MM	PC UPC	Chrome	Black	FC
	065-218-51	MFC-12-P-OW							Off White	
	065-218-10	MFC-12-C-BLK	FC	12	Ceramic	SM	Any	Chrome	Black	FU
	065-218-11	MFC-12-C-OW							Off White	
	065-389-20	MMTP-06-B-BLK	MTP	6	N/A	SM	APC	Black	Black	N/A
	-	MMTP-06-B-OW							Off White	
	065-378-20	MMTP-08-B-BLK	MTP	8	N/A	SM	APC	Black	Black	N/A
	-	MMTP-08-B-OW							Off White	
	065-389-30	MMTP-06-A-BLK	MTP	6	N/A	MM	PC	Aqua	Black	N/A
	-	MMTP-06-A-OW							Off White	
	065-378-30	MMTP-08-A-BLK	MTP	8	N/A	MM	PC	Aqua	Black	N/A
	-	MMTP-08-A-OW							Off White	

	Stock ID	Model #	Conn. Type	# Of Conn.	Ferrule	Mode	Fiber Polish	Conn. Color	Plate Color	Plate Code
	10-4810	MSC-06-SM-C-BLK	SC	6	Ceramic	SM	UPC	Blue	Black	SUS
	10-6178	MSC-06-SM-C-OW							Off White	
	10-1817	MSC-12-SM-C-BLK	SC	12	Ceramic	SM	UPC	Blue	Black	SUD
	10-6181	MSC-12-SM-C-OW							Off White	
	065-478-10	MSC-06D-SM-C-BLK	SC	6	Ceramic	SM	UPC	Blue	Black	SUD
	065-478-11	MSC-06D-SM-C-OW							Off White	
	10-4442	MSCA-06-SM-C-BLK	SC	6	Ceramic	SM	APC	Green	Black	SAS
	99222K	MSCA-06-SM-C-OW							Off White	
	10-5327	MSCA-12-SM-C-BLK	SC	12	Ceramic	SM	APC	Green	Black	SAD
	99224K	MSCA-12-SM-C-OW							Off White	
	065-479-10	MSCA-06D-SM-C-BLK	SC	6	Ceramic	SM	APC	Green	Black	SAD
	065-479-11	MSCA-06D-SM-C-OW							Off White	
	10-9995	MSC-06-MM-P-BLK	SC	6	Phos. Bronze	MM	PC	Beige	Black	SCS
	10-9996	MSC-06-MM-P-OW							Off White	
	10-5535	MSC-12-MM-P-BLK	SC	12	Phos. Bronze	MM	PC	Beige	Black	SCD
	065-518-10	MSC-12-MM-P-OW							Off White	
	065-477-10	MSC-06D-MM-P-BLK	SC	6	Phos. Bronze	MM	PC	Beige	Black	SCD
	065-477-11	MSC-06D-MM-P-OW							Off White	
	065-242-10	MSCG-6-MM-P-BLK	SC 10 GIG	6	Phos. Bronze	MM	PC	Aqua	Black	SGS
	065-242-11	MSCG-6-MM-P-OW							Off White	
	065-243-10	MSCG-12-MM-P-BLK	SC 10 GIG	12	Phos. Bronze	MM	PC	Aqua	Black	SGD
	065-243-11	MSCG-12-MM-P-OW							Off White	
	065-480-10	MSCG-6D-MM-P-BLK	SC 10 GIG	6	Phos. Bronze	MM	PC	Aqua	Black	SGD
	065-480-11	MSCG-6D-MM-P-OW							Off White	

Specifications subject to change without notice.

© Multilink, Inc. 2013 • All Rights Reserved

	Stock ID	Model #	Conn. Type	# Of Conn.	Ferrule	Mode	Fiber Polish	Conn. Color	Plate Color	Plate Code
	10-9709	MLCD-12-SM-C-BLK	LC	12	Ceramic	SM	UPC	Blue	Black	LCUD
	10-9710	MLCD-12-SM-C-OW							Off White	
	065-244-10	MLCQ-24-SM-C-BLK	LC	24	Ceramic	SM	UPC	Blue	Black	LCUQ
	065-244-11	MLCQ-24-SM-C-OW							Off White	
	10-9123	MLCDA-12-SM-C-BLK	LC	12	Ceramic	SM	APC	Green	Black	LCAD
	065-508-10	MLCDA-12-SM-C-OW							Off White	
	065-420-10	MLCQA-24-SM-C-BLK	LC	24	Ceramic	SM	APC	Green	Black	LCAQ
	065-420-11	MLCQA-24-SM-C-OW							Off White	
	10-3626	MLCD-12-MM-P-BLK	LC	12	Phos. Bronze	MM	PC	Beige	Black	LCPD
	10-3627	MLCD-12-MM-P-OW							Off White	
	065-225-10	MLCQ-24-MM-P-BLK	LC	24	Phos. Bronze	MM	PC	Beige	Black	LCPQ
	065-225-11	MLCQ-24-MM-P-OW							Off White	
	065-245-10	MLCDG-12-MM-P-BLK	LC 10 GIG	12	Phos. Bronze	MM	PC	Aqua	Black	LCGD
	065-245-11	MLCDG-12-MM-P-OW							Off White	
	065-246-10	MLCQG-24-MM-P-BLK	LC 10 GIG	24	Phos. Bronze	MM	PC	Aqua	Black	LCGQ
	065-246-11	MLCQG-24-MM-P-OW							Off White	



	Stock ID	Description
A	065-387-10	SC Simplex Panel Plug
B	065-388-10	SC Duplex Panel Plug
C	065-765-10	SC Simplex Panel Plug (Flangeless)
D	065-766-10	LC Duplex Panel Plug
E	065-767-10	ST Panel Plug

	Stock ID	Model #	Conn. Type	# Of Conn. Holes	Plate Color
	10-6061	MSCB-06-BB-BLK	SC	6	Black
	10-6063	MSCB-06-BB-OW			Off White
	065-390-10	MSCD-03-NB-BLK	SC DUPLEX or LC QUAD	3	Black
	065-390-11	MSCD-03-NB-OW			Off White
	10-5534	MSCBH-03-NB-BLK	SC DUPLEX or LC QUAD	6	Black
	10-8187	MSCBH-03-NB-OW			Off White
	10-5455	MSTA-03-BB-BLK	ST	6	Black
	10-5450	MSTA-03-BB-OW			Off White
	10-9188	MSTA-12-BB-BLK	ST	12	Black
	10-9189	MSTA-12-BB-OW			Off White
	10-4610	MLCD-03-NB-BLK	LC DUPLEX	6	Black
	10-4609	MLCD-03-NB-OW			Off White
	10-8750	MFCB-03-DB-BLK	FC	6	Black
	10-8752	MFCB-03-DB-OW			Off White
	065-227-10	MFCB-12-DB-BLK	FC	12	Black
	065-227-11	MFCB-12-DB-OW			Off White
	10-7666	MFMB-600BB-BLK	-	0	Black
	10-7668	MFMB-600BB-OW			Off White
	065-354-10	MKJB-04-NB-BLK	KEYSTONE	4	Black
	065-354-11	MKJB-04-NB-OW			Off White
	065-389-10	MTP-06-BK	MTP	6	Black
	-	MTP-06-OW			Off White
	065-378-10	MTP-08-BK	MTP	8	Black
	-	MTP-08-OW			Off White

	Stock ID	Type	Fiber Polish	Mode	Sleeve Material	Color	Foot Print
	99306	ST	Any	MM	Phos. Bronze	Chrome	ST
	99307	ST	Any	SM	Ceramic	Chrome	ST
	99309	FC	Any	MM	Phos. Bronze	Chrome	FC
	99310	FC	Any	SM	Ceramic	Chrome	FC
	10-1688	MTRJ	PC	MM or SM	N/A	Black	MTRJ
	99304	SC Simplex	UPC	SM	Ceramic	Blue	SC Simplex
	10-5513	SC Duplex	UPC	SM	Ceramic	Blue	SC Duplex
	10-3642	SC Simplex	APC	SM	Ceramic	Green	SC Simplex
	10-5378	SC Duplex	APC	SM	Ceramic	Green	SC Duplex
	10-5382	SC Simplex	PC	MM	Phos. Bronze	Beige	SC Simplex
	99302	SC Duplex	PC	MM	Phos. Bronze	Beige	SC Duplex
	065-236-10	SC Simplex 10 GIG	PC	MM	Phos. Bronze	Aqua	SC Simplex
	065-237-10	SC Duplex 10 GIG	PC	MM	Phos. Bronze	Aqua	SC Duplex

	Stock ID	Type	Fiber Polish	Mode	Sleeve Material	Color	Foot Print
	10-4605	LC Duplex	UPC	SM	Ceramic	Blue	LC Duplex
	065-607-10	LC Duplex	UPC	SM	Ceramic	Blue	SC Simplex
	065-239-10	LC Quad	UPC	SM	Ceramic	Blue	SC Duplex
	065-414-10	LC Duplex	APC	SM	Ceramic	Green	LC Duplex
	065-597-10	LC Duplex	APC	SM	Ceramic	Green	SC Simplex
	065-419-10	LC Quad	APC	SM	Ceramic	Green	SC Duplex
	10-9711	LC Duplex	PC	MM	Phos. Bronze	Beige	LC Duplex
	065-204-10	LC Duplex	PC	MM	Phos. Bronze	Beige	SC Simplex
	065-238-10	LC Quad	PC	MM	Phos. Bronze	Beige	SC Duplex
	065-240-10	LC Duplex 10 GIG	PC	MM	Phos. Bronze	Aqua	SC Simplex
	065-241-10	LC Quad 10 GIG	PC	MM	Phos. Bronze	Aqua	SC Duplex
	065-146-10	MTP	APC	SM	N/A	Black	MTP
	065-146-20	MTP	PC	MM	N/A	Aqua	MTP

Specifications subject to change without notice.

© Multilink, Inc. 2013 • All Rights Reserved

CT-X System

NEW

CT-X

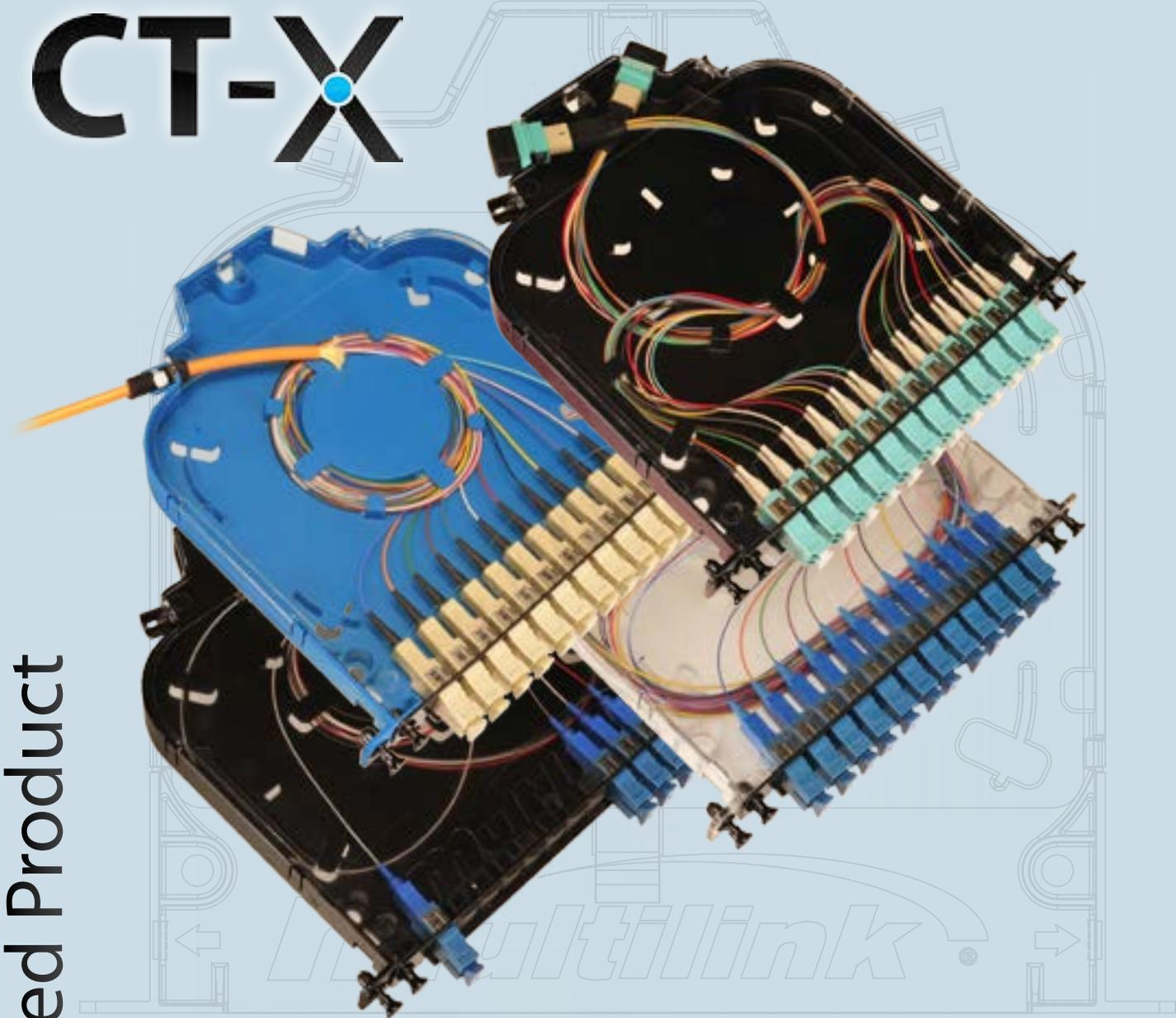

Featured Product

The Multilink CT-X is a versatile platform to fulfill your fiber infrastructure requirements. The core of the design is the base module that accommodates patching, splicing, splitters, or plug-and-play connections. All connections to the CT-X, including the adapter panel, are non captive, allowing greater flexibility during splicing, installation, and future changes. All back connections to the base are bidirectional, allowing fiber to enter from either left or right build outs, or both. The CT-X base is available in three colors, multiple adapter panels, and a clear cover for quick viewing of fiber layout.

CT-X System



patch, splice, mtp or splitter. configure them your way.

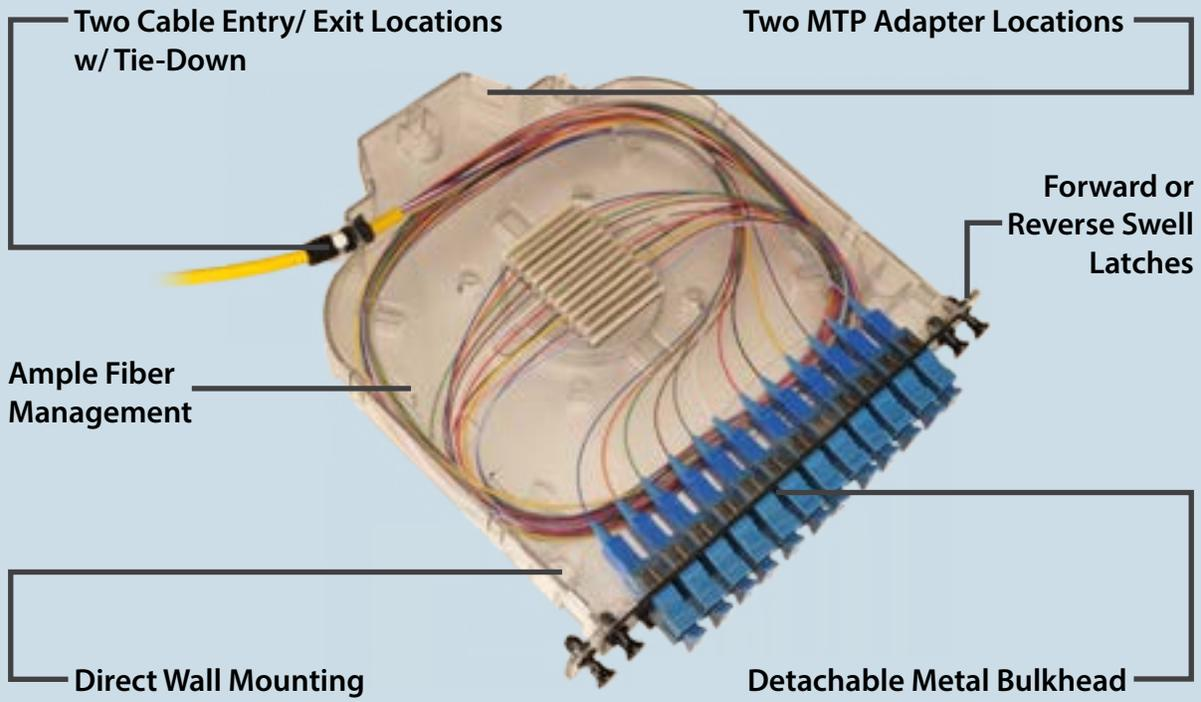



CT-X Patch & Splice

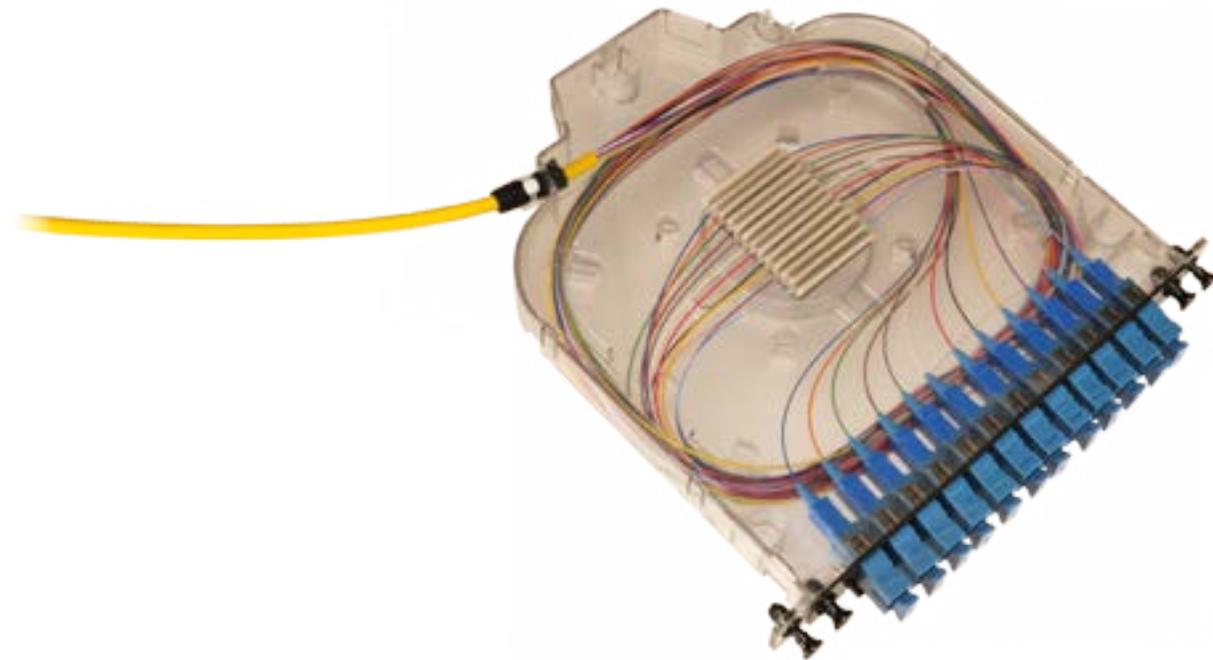

Ordering Information

Color	
BL	Black
CY	Cyan
CL	Clear

Pigtail	
P	1M Included
N	Not Included

CT-X - **PS** - **BL** - **12** - **SCA** - **P**

Fiber Count	
LC	12
SC	12

Adapter/ Polish, Fiber	
LCA	LC/APC SM 9µm
LCU	LC/UPC SM 9µm
SCA	SC/APC SM 9µm
SCU	SC/UPC SM 9µm
LC1	LC/PC OM1 62.5µm
LC2	LC/PC OM2 50µm
LC3	LC/PC OM3 50µm
LC4	LC/PC OM4 50µm
SC1	SC/PC OM1 62.5µm
SC2	SC/PC OM2 50µm
SC3	SC/PC OM3 50µm
SC4	SC/PC OM4 50µm

Cartridge Terminal System	
CT-X	

Patch & Splice	
PS	



CT-X MTP

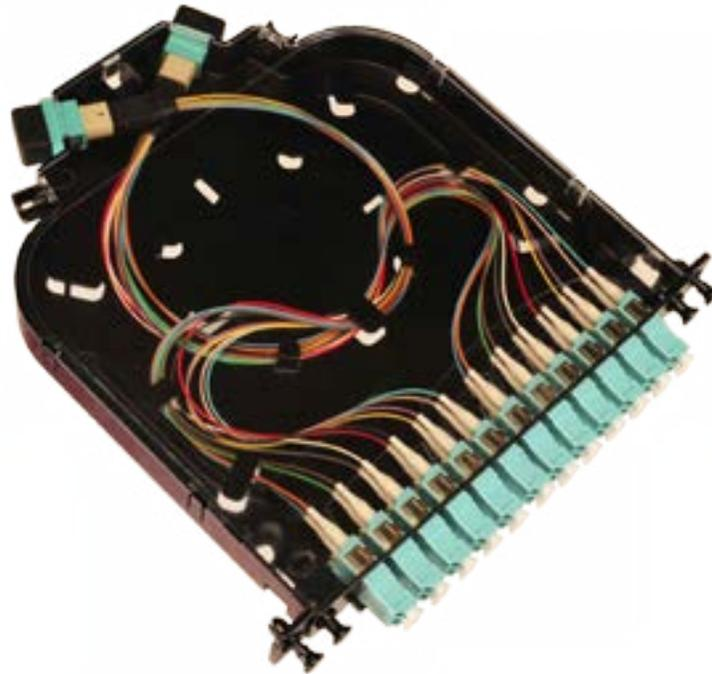

Ordering Information

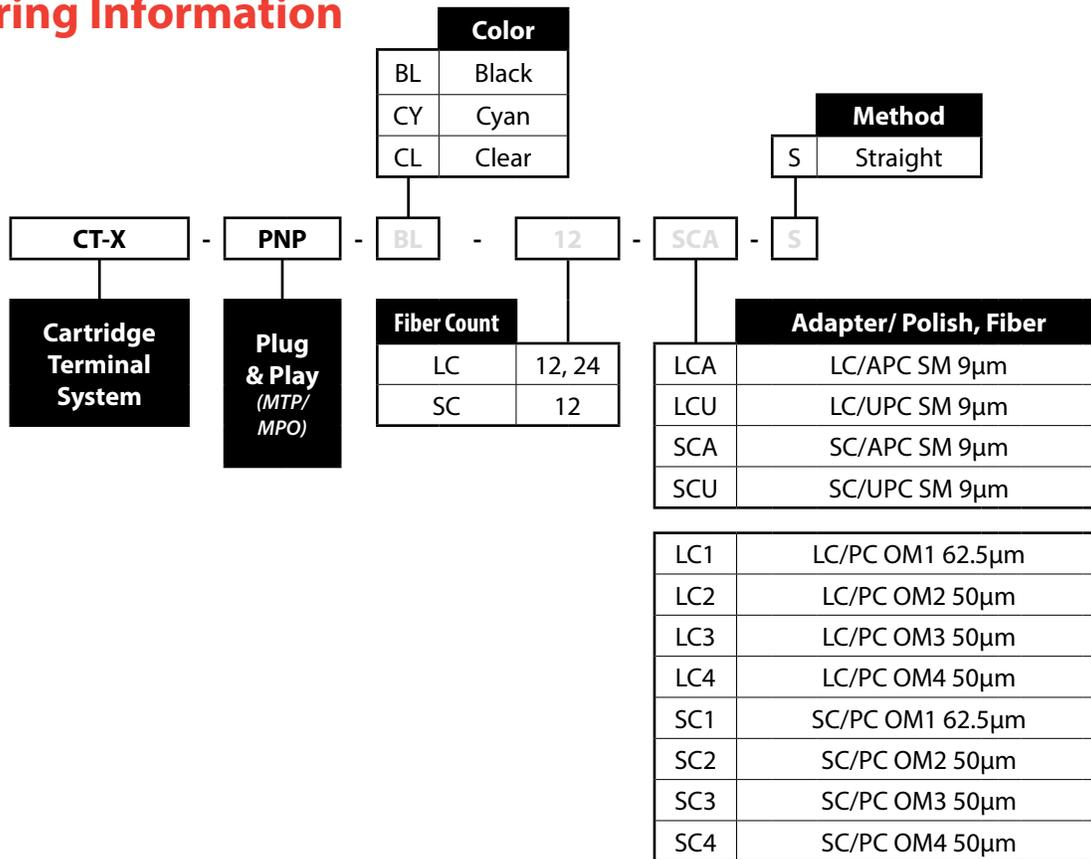

Note: MTP(s) are male pinned.



CT-X Splitter

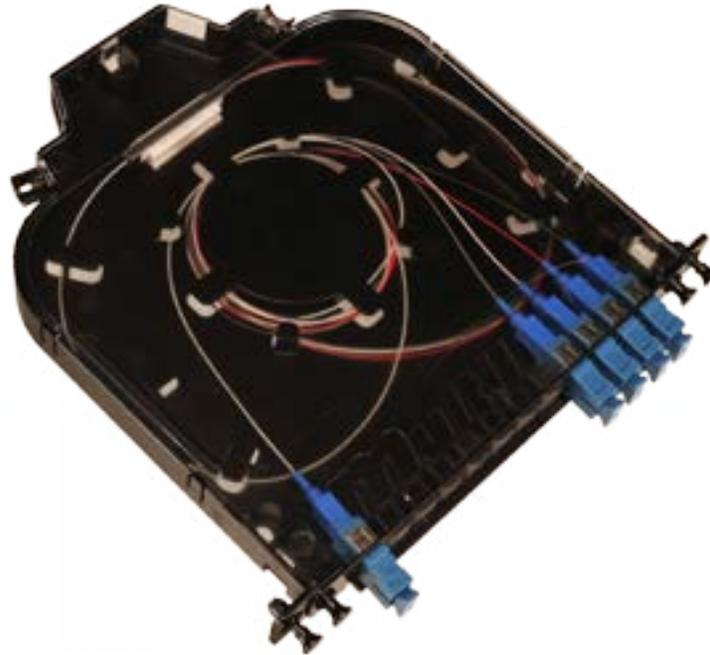

Ordering Information

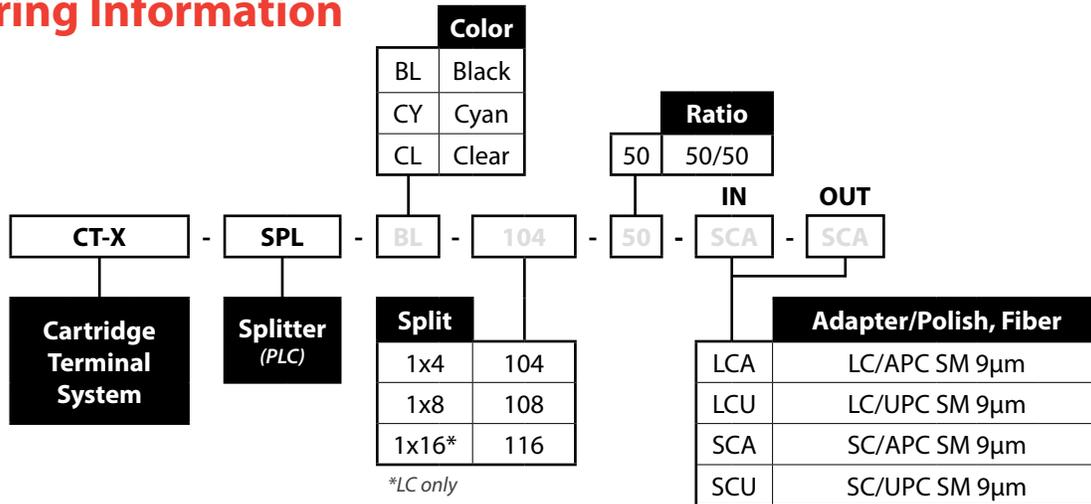

Operating Wavelength (nm) 1260~1650

	Insertion Loss	Return Loss	Directivity
1x4	≤7.4 dB	≥55 dB	≥55 dB
1x8	≤10.3 dB		
1x16	≤13.8 dB		

Fiber Termination Modules / FTMs

Pigtail Version

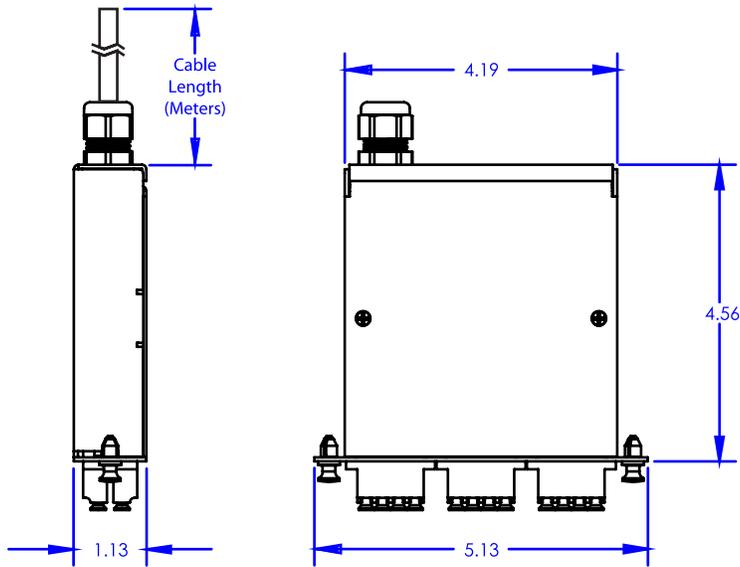

MTP Version

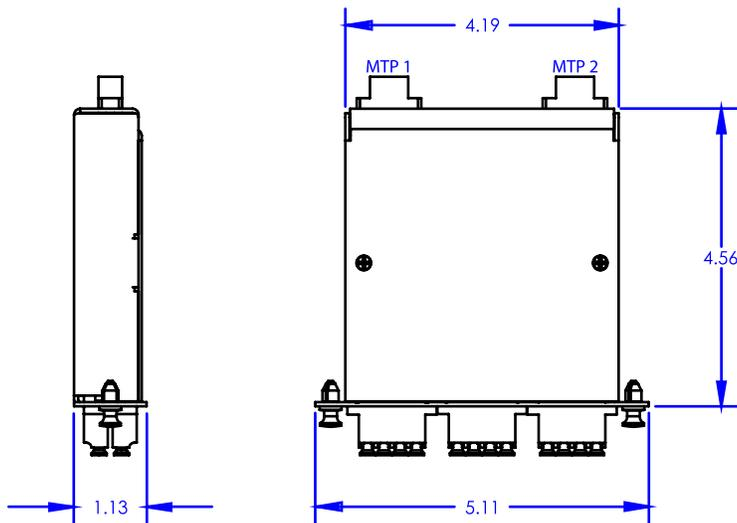

Fiber Termination Modules / FTMs

Splice Version

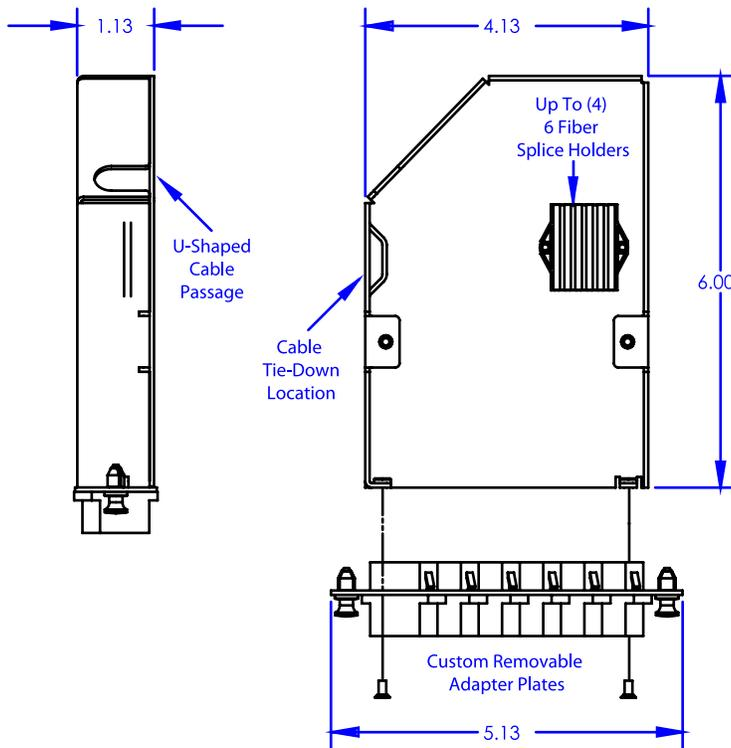

Ordering Information

FTM				
Fiber Termination Module	Number of Adapters	Front Adapter Type	Fiber Type	Back Adapter Type
	06	SC/UPC	SM, 9/125µm	P Pigtail Version Includes * length in meters of OFNR Distribution Jacketed Fiber type per adapter type.
	12	SC/APC	SM, 9/125µm	
	24	LC/UPC	SM, 9/125µm	
	*SC Only	SC/PC50	MM, 50/125µm (OM2)	M1 or M2 MTP Version Includes 1 or 2 MTP adapters in back connected to adapters in front with fiber type per adapter type. M1=1-12 Adapters M2=13-24 Adapters
		SC/PC62	MM, 62.5/125µm (OM1)	
		SC/PCLO	MM, 50/125µm (OM3) Laser Optimized	S1 Splice Version Includes 1 meter of color coded 900µm fiber connected to adapters in front with fiber type per adapter type.
		LC/PC50	MM, 50/125µm (OM2)	
		LC/PC62	MM, 62.5/125µm (OM1)	SR1 Splice Version Includes 1 meter of color coded Ribbon fiber connected to adapters in front with fiber type per adapter.
		LC/PCLO	MM, 50/125µm (OM3) Laser Optimized	

*Note: FTM Modules are typically suited to rack mounted fiber enclosures. All fibers used in FTM assemblies are SMF28e+ (ITU-T G.652) for SM and Corning™ Clearcurve (ITU G.651.1) for MM.

PLC Optical Splitters, LGX (Multilink™), & 19" Rack Mounting

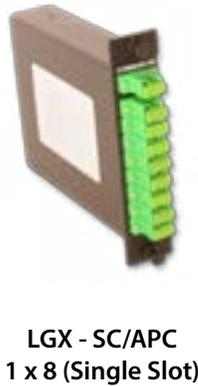
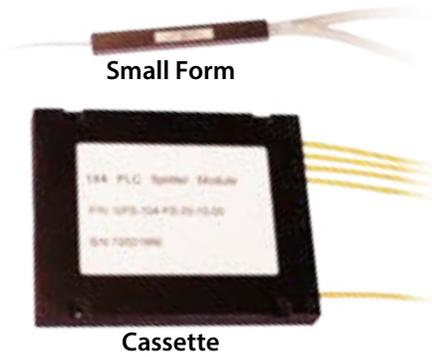

Multilink Fiber Optics Line of PLC splitters offers superior performance and field- proven reliability for harsh environments. Features include low insertion loss (IL), low polarization dependent loss (PDL), high port to port uniformity, and compact space saving designs.

Applications

- FTTx PON Networks
- CATV
- CWDM & DWDM Systems

Features & Benefits

- PLC Telcordia compliant GR1221
- Low Insertion Loss (IL)
- Low PDL
- Space-saving design
- Customized packaging available

Specifications

Parameters	1 x 4	1 x 8	1 x 16	1 x 32
Operating wavelength nm	1260-1650			
Insertion loss typ. / max. dB	7.1 / 7.4	10.4 / 10.7	13.6 / 13.9	16.8 / 17.2
Uniformity dB	≤ 0.8	≤ 1.0	≤ 1.4	≤ 1.6
PDL dB	≤ 0.3	≤ 0.3	≤ 0.3	≤ 0.3
Return loss dB	≥ 55	≥ 55	≥ 55	≥ 55
Directivity dB	≥ 55	≥ 55	≥ 55	≥ 55
Maximum input power mW	250			
Operation Temperature C°	-40 ~ +85			
Storage Temperature C°	-40 ~ +85			
Small Form Dimensions mm	4 x 7 x 60		6 x 19 x 100	
Reggeized Cassette Dimensions mm	8 x 80 x 100		16 x 80 x 136	18 x 114 x 140
LGX Module Dimensions mm Standard LC & SC Adapters Compact LC Adapters Only	129 x 125 x 28	129 x 125 x 28	129 x 125 x 56 129 x 125 x 28	129 x 125 x 112 129 x 125 x 56
19" Rack Mount Dimensions mm (width x depth x height) in (width x depth x height)	N/A		431 x 235 x 44 17 x 9.25 x 1.75	

Operating wavelength is design guaranteed. Above test results measured without connectors.

Ordering Information

Small Form & Cassette

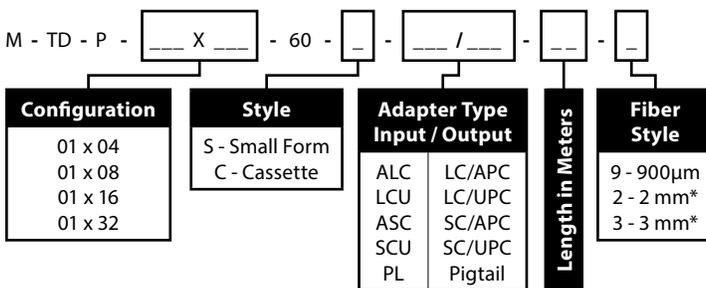

*Note: 2 & 3 mm fiber available only in Cassette style.

LGX & Rack Mount

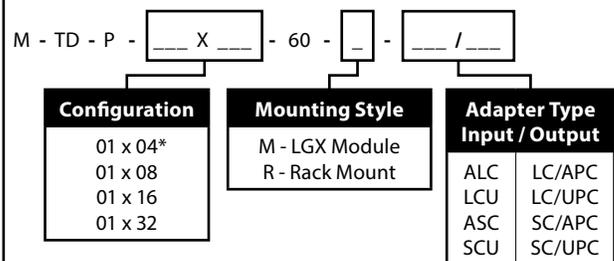

*Note: 1x4 Configuration not available as rack module. All optical splitters available in several custom configurations and packaging options contact customer service for additional information.

For Use In Rack And Wall Mount Fiber Distribution Enclosures

		Stock ID	Connector/ Polish	# of Fibers	Overall Length (m)
Single Mode (OS1) 9/125/900µm	Spiral Wrapped	10-6415	SC/UPC	6	3
		10-6416		12	
		10-6417	SC/APC	6	3
		10-6418		12	
		065-089-10	ST/UPC	6	3
		065-090-10		12	
		065-808-10	LC/UPC	6	3
		065-180-10		12	
		10-8703	FC/UPC	6	3
		065-365-10		12	
	065-810-10	LC/APC	6	3	
			12		
	OFNR (Yellow)	065-370-10	SC/UPC	6	3
		065-371-10		12	
		065-394-10	SC/APC	6	3
		065-395-10		12	
		065-374-10	ST/UPC	6	3
		065-375-10		12	
		065-809-10	LC/UPC	6	3
065-396-10		12			
065-811-10		LC/APC	6	3	
065-437-10			12		
Single Mode Ribbon	OFNR (Yellow)	065-282-10	SC/UPC	12	3
		065-523-10	SC/APC	12	3
		065-561-10	LC/UPC	12	3

For GSA / Buy American Compliant Pigtails Please Add (-US) To The End Of Your Stock ID ex: 10-6415-US

Point-Of-Purchase Packaging Sale Bags Include Fiber Cable, Test Data & Labeling

Specifications subject to change without notice.

© Multilink, Inc. 2013 • All Rights Reserved

For Use In Rack And Wall Mount Fiber Distribution Enclosures

		Stock ID	Connector/ Polish	# of Fibers	Overall Length (m)
Multi Mode (OM1) 62.5/125/900µm	Spiral Wrapped	065-055-10	SC/PC	6	3
		065-228-10		12	
		065-056-10	ST/PC	6	3
		065-101-10		12	
		065-812-10	LC/PC	6	3
		065-179-10		12	
	065-178-10	FC/PC	6	3	
	OFNR (Orange)	065-372-10	SC/PC	6	3
		065-373-10		12	
		065-376-10	ST/PC	6	3
		065-377-10		12	
		065-813-10	LC/PC	6	3
065-397-10		12			
Multi Mode (OM3) 50/125/900µm	OFNR (Aqua)	065-439-10	SC/PC	6	3
		065-438-10		12	
		065-494-10	ST/PC	12	3
		065-815-10	LC/PC	6	3
		065-487-10		12	



Fiber Fan Out Kits

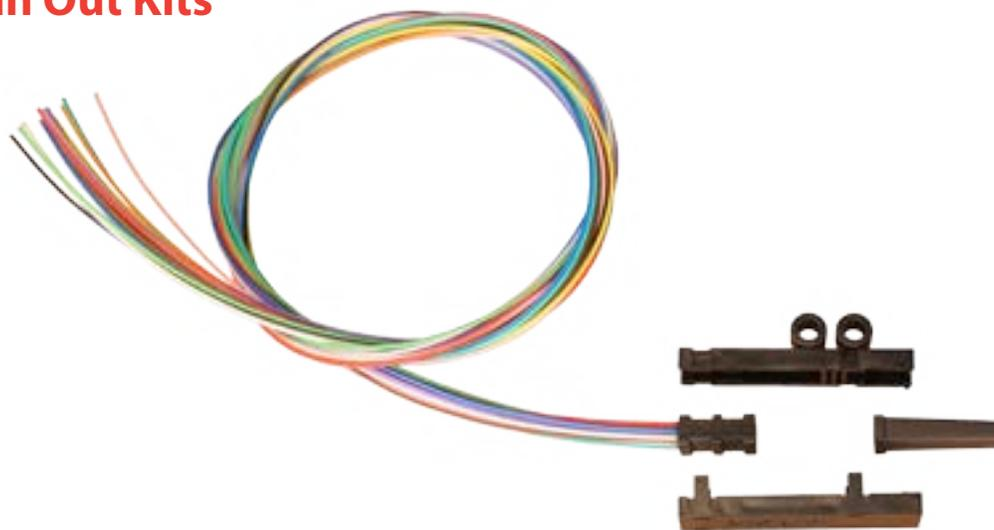

Stock ID	Description	UOM
065-744-10	Fan Out Kit - 6 Fiber - 25"	Each
065-745-10	Fan Out Kit - 12 Fiber - 25"	Each
065-749-10	Fan Out Kit - 12 Fiber - 36"	Each

Single Mode Simplex Jumpers

UPC / Simplex



Stock ID	# 1 Connector	# 2 Connector	Cable Core/Clad	Cable Jacket	Cable Color	Length (m)
10-6310	ST/UPC	ST/UPC	9/125µm	2.9-3.0mm	Yellow	1
10-6311	ST/UPC	ST/UPC	9/125µm	2.9-3.0mm	Yellow	2
10-6312	ST/UPC	ST/UPC	9/125µm	2.9-3.0mm	Yellow	3
10-6313	ST/UPC	ST/UPC	9/125µm	2.9-3.0mm	Yellow	5
10-6314	ST/UPC	ST/UPC	9/125µm	2.9-3.0mm	Yellow	10



10-6315	SC/UPC	SC/UPC	9/125µm	2.9-3.0mm	Yellow	1
10-6316	SC/UPC	SC/UPC	9/125µm	2.9-3.0mm	Yellow	2
10-6317	SC/UPC	SC/UPC	9/125µm	2.9-3.0mm	Yellow	3
10-6318	SC/UPC	SC/UPC	9/125µm	2.9-3.0mm	Yellow	5
10-6319	SC/UPC	SC/UPC	9/125µm	2.9-3.0mm	Yellow	10



10-6320	LC/UPC	LC/UPC	9/125µm	2.9-3.0mm	Yellow	1
10-6321	LC/UPC	LC/UPC	9/125µm	2.9-3.0mm	Yellow	2
10-6322	LC/UPC	LC/UPC	9/125µm	2.9-3.0mm	Yellow	3
10-6323	LC/UPC	LC/UPC	9/125µm	2.9-3.0mm	Yellow	5
10-6324	LC/UPC	LC/UPC	9/125µm	2.9-3.0mm	Yellow	10



10-6325	FC/UPC	FC/UPC	9/125µm	2.9-3.0mm	Yellow	1
10-6326	FC/UPC	FC/UPC	9/125µm	2.9-3.0mm	Yellow	2
10-6327	FC/UPC	FC/UPC	9/125µm	2.9-3.0mm	Yellow	3
10-6328	FC/UPC	FC/UPC	9/125µm	2.9-3.0mm	Yellow	5
10-6329	FC/UPC	FC/UPC	9/125µm	2.9-3.0mm	Yellow	10

APC / Simplex



Stock ID	# 1 Connector	# 2 Connector	Cable Core/Clad	Cable Jacket	Cable Color	Length (m)
10-6400	FC/APC	FC/APC	9/125µm	2.9-3.0mm	Yellow	1
10-6401	FC/APC	FC/APC	9/125µm	2.9-3.0mm	Yellow	2
10-6402	FC/APC	FC/APC	9/125µm	2.9-3.0mm	Yellow	3
10-6403	FC/APC	FC/APC	9/125µm	2.9-3.0mm	Yellow	5
10-6404	FC/APC	FC/APC	9/125µm	2.9-3.0mm	Yellow	10



10-6405	SC/APC	SC/APC	9/125µm	2.9-3.0mm	Yellow	1
10-6406	SC/APC	SC/APC	9/125µm	2.9-3.0mm	Yellow	2
10-6407	SC/APC	SC/APC	9/125µm	2.9-3.0mm	Yellow	3
10-6408	SC/APC	SC/APC	9/125µm	2.9-3.0mm	Yellow	5
10-6409	SC/APC	SC/APC	9/125µm	2.9-3.0mm	Yellow	10

For GSA / Buy American Compliant Jumpers Please Add (-US) To The End Of Your Stock ID ex: 10-6415-US



Point-Of-Purchase Packaging Sale Bags Include Fiber Cable, Test Data & Labeling

Single Mode Duplex Jumpers

UPC / Duplex



Stock ID	# 1 Connector	# 2 Connector	Cable Core/Clad	Cable Jacket	Cable Color	Length (m)
10-6330	ST/UPC	ST/UPC	9/125µm	2.9-3.0mm	Yellow	1
10-6331	ST/UPC	ST/UPC	9/125µm	2.9-3.0mm	Yellow	2
10-6332	ST/UPC	ST/UPC	9/125µm	2.9-3.0mm	Yellow	3
10-6333	ST/UPC	ST/UPC	9/125µm	2.9-3.0mm	Yellow	5
10-6334	ST/UPC	ST/UPC	9/125µm	2.9-3.0mm	Yellow	10

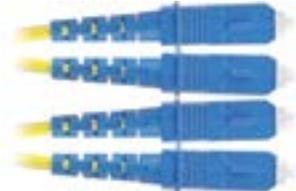

10-6335	SC/UPC	SC/UPC	9/125µm	2.9-3.0mm	Yellow	1
10-6336	SC/UPC	SC/UPC	9/125µm	2.9-3.0mm	Yellow	2
10-6337	SC/UPC	SC/UPC	9/125µm	2.9-3.0mm	Yellow	3
10-6338	SC/UPC	SC/UPC	9/125µm	2.9-3.0mm	Yellow	5
10-6339	SC/UPC	SC/UPC	9/125µm	2.9-3.0mm	Yellow	10

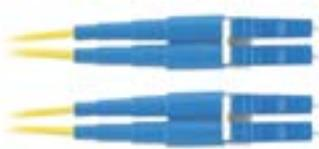

10-6340	LC/UPC	LC/UPC	9/125µm	2.9-3.0mm	Yellow	1
10-6341	LC/UPC	LC/UPC	9/125µm	2.9-3.0mm	Yellow	2
10-6342	LC/UPC	LC/UPC	9/125µm	2.9-3.0mm	Yellow	3
10-6343	LC/UPC	LC/UPC	9/125µm	2.9-3.0mm	Yellow	5
10-6344	LC/UPC	LC/UPC	9/125µm	2.9-3.0mm	Yellow	10

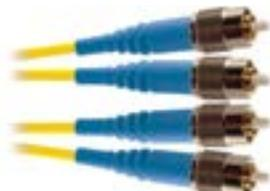

10-6345	FC/UPC	FC/UPC	9/125µm	2.9-3.0mm	Yellow	1
10-6346	FC/UPC	FC/UPC	9/125µm	2.9-3.0mm	Yellow	2
10-6347	FC/UPC	FC/UPC	9/125µm	2.9-3.0mm	Yellow	3
10-6348	FC/UPC	FC/UPC	9/125µm	2.9-3.0mm	Yellow	5
10-6349	FC/UPC	FC/UPC	9/125µm	2.9-3.0mm	Yellow	10

APC / Duplex

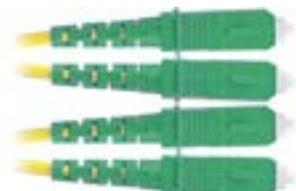

Stock ID	# 1 Connector	# 2 Connector	Cable Core/Clad	Cable Jacket	Cable Color	Length (m)
065-529-10	SC/APC	SC/APC	9/125µm	2.9-3.0mm	Yellow	1
065-527-10	SC/APC	SC/APC	9/125µm	2.9-3.0mm	Yellow	2
065-489-10	SC/APC	SC/APC	9/125µm	2.9-3.0mm	Yellow	3
065-534-10	SC/APC	SC/APC	9/125µm	2.9-3.0mm	Yellow	5
065-512-10	SC/APC	SC/APC	9/125µm	2.9-3.0mm	Yellow	10

For GSA / Buy American Compliant Jumpers Please Add (-US) To The End Of Your Stock ID ex: 10-6415-US



Point-Of-Purchase Packaging Sale Bags Include Fiber Cable, Test Data & Labeling

Single Mode Hybrid Jumpers

UPC / Simplex



Stock ID	# 1 Connector	# 2 Connector	Cable Core/Clad	Cable Jacket	Cable Color	Length (m)
10-6380	ST/UPC	SC/UPC	9/125µm	2.9-3.0mm	Yellow	1
10-6381	ST/UPC	SC/UPC	9/125µm	2.9-3.0mm	Yellow	2
10-6382	ST/UPC	SC/UPC	9/125µm	2.9-3.0mm	Yellow	3
10-6383	ST/UPC	SC/UPC	9/125µm	2.9-3.0mm	Yellow	5
10-6384	ST/UPC	SC/UPC	9/125µm	2.9-3.0mm	Yellow	10



10-6385	LC/UPC	SC/UPC	9/125µm	2.9-3.0mm	Yellow	1
10-6386	LC/UPC	SC/UPC	9/125µm	2.9-3.0mm	Yellow	2
10-6387	LC/UPC	SC/UPC	9/125µm	2.9-3.0mm	Yellow	3
10-6388	LC/UPC	SC/UPC	9/125µm	2.9-3.0mm	Yellow	5
10-6389	LC/UPC	SC/UPC	9/125µm	2.9-3.0mm	Yellow	10

UPC / Duplex

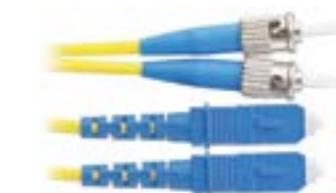

Stock ID	# 1 Connector	# 2 Connector	Cable Core/Clad	Cable Jacket	Cable Color	Length (m)
10-6390	ST/UPC	SC/UPC	9/125µm	2.9-3.0mm	Yellow	1
10-6391	ST/UPC	SC/UPC	9/125µm	2.9-3.0mm	Yellow	2
10-6392	ST/UPC	SC/UPC	9/125µm	2.9-3.0mm	Yellow	3
10-6393	ST/UPC	SC/UPC	9/125µm	2.9-3.0mm	Yellow	5
10-6394	ST/UPC	SC/UPC	9/125µm	2.9-3.0mm	Yellow	10

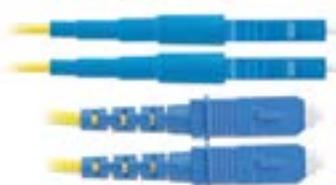

10-6395	LC/UPC	SC/UPC	9/125µm	2.9-3.0mm	Yellow	1
10-6396	LC/UPC	SC/UPC	9/125µm	2.9-3.0mm	Yellow	2
10-6397	LC/UPC	SC/UPC	9/125µm	2.9-3.0mm	Yellow	3
10-6398	LC/UPC	SC/UPC	9/125µm	2.9-3.0mm	Yellow	5
10-6399	LC/UPC	SC/UPC	9/125µm	2.9-3.0mm	Yellow	10

APC / Simplex



Stock ID	# 1 Connector	# 2 Connector	Cable Core/Clad	Cable Jacket	Cable Color	Length (m)
10-6410	FC/APC	SC/APC	9/125µm	2.9-3.0mm	Yellow	1
10-6411	FC/APC	SC/APC	9/125µm	2.9-3.0mm	Yellow	2
10-6412	FC/APC	SC/APC	9/125µm	2.9-3.0mm	Yellow	3
10-6413	FC/APC	SC/APC	9/125µm	2.9-3.0mm	Yellow	5
10-6414	FC/APC	SC/APC	9/125µm	2.9-3.0mm	Yellow	10

For GSA / Buy American Compliant Jumpers Please Add (-US) To The End Of Your Stock ID ex: 10-6415-US



Point-Of-Purchase Packaging Sale Bags Include Fiber Cable, Test Data & Labeling

Multi Mode Simplex Jumpers

50/125µm



Stock ID	# 1 Connector	# 2 Connector	Cable Core/Clad	Cable Jacket	Cable Color	Length (m)
10-6266	ST	ST	50/125µm	2.9-3.0mm	Orange	1
10-6267	ST	ST	50/125µm	2.9-3.0mm	Orange	3
10-6268	ST	ST	50/125µm	2.9-3.0mm	Orange	5
10-6269	ST	ST	50/125µm	2.9-3.0mm	Orange	10



10-6270	SC	SC	50/125µm	2.9-3.0mm	Orange	1
10-6271	SC	SC	50/125µm	2.9-3.0mm	Orange	3
10-6272	SC	SC	50/125µm	2.9-3.0mm	Orange	5
10-6273	SC	SC	50/125µm	2.9-3.0mm	Orange	10



10-6274	LC	LC	50/125µm	2.9-3.0mm	Orange	1
10-6275	LC	LC	50/125µm	2.9-3.0mm	Orange	3
10-6276	LC	LC	50/125µm	2.9-3.0mm	Orange	5
10-6277	LC	LC	50/125µm	2.9-3.0mm	Orange	10

62.5/125µm



Stock ID	# 1 Connector	# 2 Connector	Cable Core/Clad	Cable Jacket	Cable Color	Length (m)
10-6241	ST	ST	62.5/125µm	2.9-3.0mm	Orange	1
10-6242	ST	ST	62.5/125µm	2.9-3.0mm	Orange	2
10-6243	ST	ST	62.5/125µm	2.9-3.0mm	Orange	3
10-6244	ST	ST	62.5/125µm	2.9-3.0mm	Orange	5
10-6245	ST	ST	62.5/125µm	2.9-3.0mm	Orange	10



10-6246	SC	SC	62.5/125µm	2.9-3.0mm	Orange	1
10-6247	SC	SC	62.5/125µm	2.9-3.0mm	Orange	2
10-6248	SC	SC	62.5/125µm	2.9-3.0mm	Orange	3
10-6249	SC	SC	62.5/125µm	2.9-3.0mm	Orange	5
10-6250	SC	SC	62.5/125µm	2.9-3.0mm	Orange	10



10-6251	LC	LC	62.5/125µm	2.9-3.0mm	Orange	1
10-6252	LC	LC	62.5/125µm	2.9-3.0mm	Orange	2
10-6253	LC	LC	62.5/125µm	2.9-3.0mm	Orange	3
10-6254	LC	LC	62.5/125µm	2.9-3.0mm	Orange	5
10-6255	LC	LC	62.5/125µm	2.9-3.0mm	Orange	10

For GSA / Buy American Compliant Jumpers Please Add (-US) To The End Of Your Stock ID ex: 10-6415-US

Point-Of-Purchase Packaging Sale Bags Include Fiber Cable, Test Data & Labeling

Multi Mode Duplex Jumpers

50/125µm



Stock ID	# 1 Connector	# 2 Connector	Cable Core/Clad	Cable Jacket	Cable Color	Length (m)
10-6194	ST	ST	50/125µm	2.9-3.0mm	Orange	1
10-6195	ST	ST	50/125µm	2.9-3.0mm	Orange	3
10-6196	ST	ST	50/125µm	2.9-3.0mm	Orange	5
10-6197	ST	ST	50/125µm	2.9-3.0mm	Orange	10

10-6198	SC	SC	50/125µm	2.9-3.0mm	Orange	1
10-6199	SC	SC	50/125µm	2.9-3.0mm	Orange	3
10-6200	SC	SC	50/125µm	2.9-3.0mm	Orange	5
10-6201	SC	SC	50/125µm	2.9-3.0mm	Orange	10

10-6202	LC	LC	50/125µm	2.9-3.0mm	Orange	1
10-6203	LC	LC	50/125µm	2.9-3.0mm	Orange	3
10-6204	LC	LC	50/125µm	2.9-3.0mm	Orange	5
10-6205	LC	LC	50/125µm	2.9-3.0mm	Orange	10

62.5/125µm

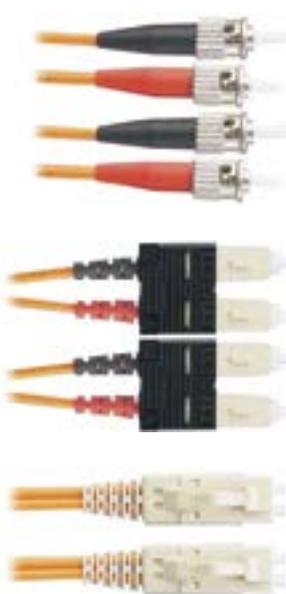

Stock ID	# 1 Connector	# 2 Connector	Cable Core/Clad	Cable Jacket	Cable Color	Length (m)
10-6278	ST	ST	62.5/125µm	2.9-3.0mm	Orange	1
10-6279	ST	ST	62.5/125µm	2.9-3.0mm	Orange	2
10-6280	ST	ST	62.5/125µm	2.9-3.0mm	Orange	3
10-6281	ST	ST	62.5/125µm	2.9-3.0mm	Orange	5
10-6282	ST	ST	62.5/125µm	2.9-3.0mm	Orange	10

10-6283	SC	SC	62.5/125µm	2.9-3.0mm	Orange	1
10-6284	SC	SC	62.5/125µm	2.9-3.0mm	Orange	2
10-6285	SC	SC	62.5/125µm	2.9-3.0mm	Orange	3
10-6286	SC	SC	62.5/125µm	2.9-3.0mm	Orange	5
10-6287	SC	SC	62.5/125µm	2.9-3.0mm	Orange	10

10-6288	LC	LC	62.5/125µm	2.9-3.0mm	Orange	1
10-6289	LC	LC	62.5/125µm	2.9-3.0mm	Orange	2
10-6290	LC	LC	62.5/125µm	2.9-3.0mm	Orange	3
10-6291	LC	LC	62.5/125µm	2.9-3.0mm	Orange	5
10-6292	LC	LC	62.5/125µm	2.9-3.0mm	Orange	10

For GSA / Buy American Compliant Jumpers Please Add (-US) To The End Of Your Stock ID ex: 10-6415-US



Point-Of-Purchase Packaging Sale Bags Include Fiber Cable, Test Data & Labeling

Multi Mode Hybrid Jumpers

Simplex

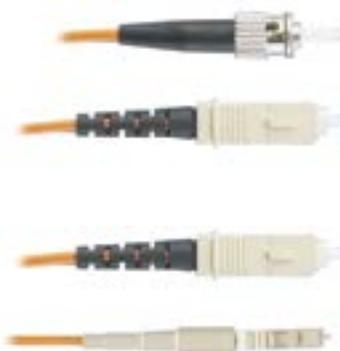

Stock ID	# 1 Connector	# 2 Connector	Cable Core/Clad	Cable Jacket	Cable Color	Length (m)
10-6256	ST	SC	62.5/125µm	2.9-3.0mm	Orange	1
10-6257	ST	SC	62.5/125µm	2.9-3.0mm	Orange	2
10-6258	ST	SC	62.5/125µm	2.9-3.0mm	Orange	3
10-6259	ST	SC	62.5/125µm	2.9-3.0mm	Orange	5
10-6260	ST	SC	62.5/125µm	2.9-3.0mm	Orange	10

10-6261	SC	LC	62.5/125µm	2.9-3.0mm	Orange	1
10-6262	SC	LC	62.5/125µm	2.9-3.0mm	Orange	2
10-6263	SC	LC	62.5/125µm	2.9-3.0mm	Orange	3
10-6264	SC	LC	62.5/125µm	2.9-3.0mm	Orange	5
10-6265	SC	LC	62.5/125µm	2.9-3.0mm	Orange	10

Duplex

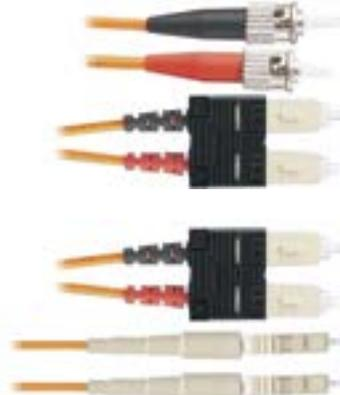

Stock ID	# 1 Connector	# 2 Connector	Cable Core/Clad	Cable Jacket	Cable Color	Length (m)
10-6184	ST	SC	62.5/125µm	2.9-3.0mm	Orange	1
10-6185	ST	SC	62.5/125µm	2.9-3.0mm	Orange	2
10-6186	ST	SC	62.5/125µm	2.9-3.0mm	Orange	3
10-6187	ST	SC	62.5/125µm	2.9-3.0mm	Orange	5
10-6188	ST	SC	62.5/125µm	2.9-3.0mm	Orange	10

10-6189	SC	LC	62.5/125µm	2.9-3.0mm	Orange	1
10-6190	SC	LC	62.5/125µm	2.9-3.0mm	Orange	2
10-6191	SC	LC	62.5/125µm	2.9-3.0mm	Orange	3
10-6192	SC	LC	62.5/125µm	2.9-3.0mm	Orange	5
10-6193	SC	LC	62.5/125µm	2.9-3.0mm	Orange	10

10Gig Fiber Jumpers

50/125µm

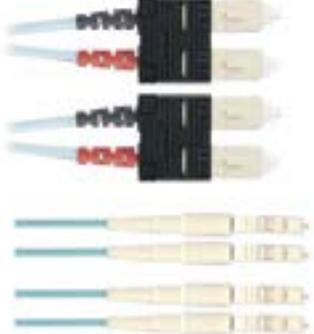

Stock ID	# 1 Connector	# 2 Connector	Cable Core/Clad	Cable Jacket	Cable Color	Length (m)
10-6229	SC	SC	50/125µm	3.0mm	Aqua	1
10-6230	SC	SC	50/125µm	3.0mm	Aqua	2
10-6231	SC	SC	50/125µm	3.0mm	Aqua	3
10-6232	SC	SC	50/125µm	3.0mm	Aqua	5

10-6237	LC	LC	50/125µm	3.0mm	Aqua	1
10-6238	LC	LC	50/125µm	3.0mm	Aqua	2
10-6239	LC	LC	50/125µm	3.0mm	Aqua	3
10-6240	LC	LC	50/125µm	3.0mm	Aqua	5

For GSA / Buy American Compliant Jumpers Please Add (-US) To The End Of Your Stock ID ex: 10-6415-US

Point-Of-Purchase Packaging Sale Bags Include Fiber Cable, Test Data & Labeling

Fiber Accessories



Connector Cleaner

Stock ID	10-6174
Part #	F1-7020
Description	Connector Cleaner (20 ft.) Universal
UOM	Each



Cleaning Media Replacement Reel

Stock ID	10-6175
Part #	F1-7021
Description	Cleaning Media Replacement Reel (Not Shown)
UOM	Each

Lint Free Kimwipes®

Stock ID	10-6171
Part #	F1-34-155
Description	Lint Free Kimwipes® / 280/Box
UOM	Each



Bottled Alcohol

Stock ID	10-6168
Part #	F1-00728
Description	Bottle Alcohol / 28oz.
UOM	Each



Automatic Dispensing Bottle

Stock ID	10-6169
Part #	F1-007P
Description	Automatic Dispensing Bottle (Amber Glass)
UOM	Each

Fiber Accessories



Fiber Optic Protective Sleeves

Transparent plastic tube and stainless steel rod designed to prevent stress and protect fusion fiber optic splices in field and factory operations. Sleeves are made of ethylene vinyl acetate (EVA) with heat activated memory, which causes them to shrink under heat. Sleeves shrink tightly to exclude air and hold the rod firmly, preventing abrasion of delicate glass fibers. Available in 60mm and 40mm.

Stock ID	Part #	Description	Dimensions	UOM
76500	MF-2170	Fiber Optic Protective Sleeves 60mm	60mm	50
76501	DH-1-40	Fiber Optic Protective Sleeves 40mm	40mm	50
065-725-10	N/A	F/Fbr Optic Ribbon Protective Sleeves 40mm	Ribbon	50
065-383-10	N/A	Ribbon Fiber Protector	Ribbon	EA



Fiber Prep Cable Cleaner

Fiber optic cable cleaner is used for quick and easy removal of cable gels, greases, tars, and oils from fiber optic and coax cables. Leaves no residue! This effective (full-strength) formula evaporates completely and contains no hazardous materials.

Stock ID	Part #	Description	Dimensions	UOM
75200	2200-FOW	Foil Pack F/O Cable Wipe	-	Each
75202	2320-FC	F/O Cable Cleaner (not shown above)	32 oz.	Each
75203	2100-FC	F/O Cable Cleaner	128 oz.	Each

Fiber Accessories



Free-Flexing, Color Coded Buffer Tubing

Why make the task of splicing fiber optic cable any harder than it has to be? Other manufacturers may offer flexible buffer tubing, but they only come in one color, making it all too easy to mismatch fiber. Multiflex™ is color coded to the standardized specifications used by fiber optic cable manufacturers to allow you to easily identify and match fiber during the splicing process. Multiflex™ comes in twelve standardized colors and is available in bulk quantities of 50' rolls. It is also free flexing, making the fiber more manageable and easier to handle in the close confines of the splice enclosure. So give Multiflex™ a try next time you splice fiber optic cable, and you'll see the difference it makes.

Part#	Description	Dimensions	Wt. lbs.	UOM
72010	2000-BL-K-Muliflex Blue Buffer Tubing (Bulk)	50' Roll	.15	Each
72020	2000-OR-K-Muliflex Orange Buffer Tubing (Bulk)	50' Roll	.15	Each
72110	2000-GR-K-Muliflex Green Buffer Tubing (Bulk)	50' Roll	.15	Each
72120	2000-BR-K-Muliflex Brown Buffer Tubing (Bulk)	50' Roll	.15	Each
72210	2000-SL-K-Muliflex Slate Buffer Tubing (Bulk)	50' Roll	.15	Each
72220	2000-WH-K-Muliflex White Buffer Tubing (Bulk)	50' Roll	.15	Each
72310	2000-RD-K-Muliflex Red Buffer Tubing (Bulk)	50' Roll	.15	Each
72320	2000-BK-K-Muliflex Black Buffer Tubing (Bulk)	50' Roll	.15	Each
72410	2000-YL-K-Muliflex Yellow Buffer Tubing (Bulk)	50' Roll	.15	Each
72420	2000-VI-K-Muliflex Violet Buffer Tubing (Bulk)	50' Roll	.15	Each
72510	2000-RS-K-Muliflex Rose Buffer Tubing (Bulk)	50' Roll	.15	Each
72520	2000-AQ-K-Muliflex Aqua Buffer Tubing (Bulk)	50' Roll	.15	Each

Basic Fiber Optic Tool Kit

Contents

- Canned Air
- PVC Electrical Tape
- 3oz. Alcohol Bottle
- Miller Fiber Stripper
- Connector Cleaner
- Kevlar Scissors
- Jacket Stripper
- Buffer Tube Stripper
- Round Cable Slitter
- (50) Foam Swabs
- Kimwipes®
- Utility Knife
- Tweezers
- Needle Nose Pliers
- Fusion Splice Sleeves
- Piano Wire
- 4 Bit Screwdriver
- Black Marker
- Safety Glasses
- (5) D-Gel Wipes
- Black Work Mat
- Fiber Disposal Unit
- Wire Marker Dispenser
- Ruler
- Fabric Tape Measure
- 1/2" Nut Driver
- (3) Economy Tie Labels
- Rugged Carrying Case
- 1 Meter 3mm Furcation Tube
- 1 Meter 900µm Furcation Tube



Stock ID	Part #	Description	UOM
10-6498	ML-F1-0053	Basic Fiber Tool Kit	Each

Fiber Management Spools



Round Spool

Stock ID	999124
Description	Round Spool
Bend Radius	1.50"
Overall Size	1.30" H x Ø3.00" spool x Ø4.70" flange
Mounting	2x Ø0.21" mounting hole
Material/ Color	Plastic/ Black
UOM	Each



Half Round Spool

Stock ID	10-7766
Description	Half Round Spool (2 pcs shown)
Bend Radius	1.25"
Overall Size	1.36" H x Ø2.50" spool x Ø3.50" flange
Mounting	1x Ø0.16" mounting hole
Material/ Color	Plastic/ Black
UOM	Each



Half Round Spool

Stock ID	10-3621
Description	Half Round Spool (2 pcs shown)
Bend Radius	1.75"
Overall Size	2.75" H x Ø3.50" spool x Ø4.50" flange
Mounting	2x Ø0.356" x 0.50" Slot, both ends 1x Ø0.125" x 0.80" Slot, both ends
Material/ Color	Plastic/ Black
UOM	Each



Slack-N-Roll

Stock ID	649-048-10
Description	Slack-N-Roll Base
Bend Radius	1.17"
Overall Size	0.61" H x Ø5.88"
Mounting	2 x 0.20" mounting holes
Material/ Color	Plastic/ Blue
UOM	Each



Spool Bracket

Stock ID	649-101-10
Description	Spool Bracket
Bend Radius	1"
Overall Size	.67" H x 4.92" W x 1.42" D
Mounting	Ø0.17" alignment stud & Ø0.18" mounting hole
Material/ Color	Plastic/ Black
UOM	Each

Fiber Management Straps & Ties



Wire Management Strap

Stock ID	99944K
Description	Wire Management Strap
Overall Size	0.63" W x Ø1.50" max.
Mounting	Pressure sensitive adhesive
Material/ Color	Velcro® brand, black
UOM	50 pieces/pack

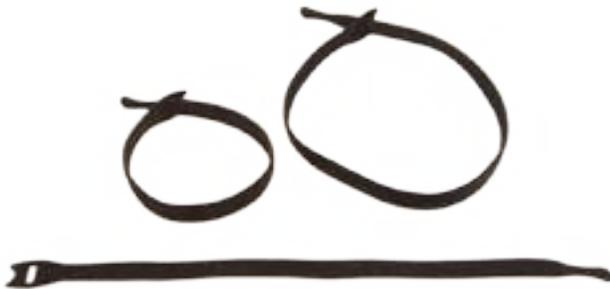

Wire Management Loop Tie

Stock ID	99000000FUT8AK
Description	Wire Management Loop Tie, 8" length
Overall Size	0.50" W x 8.0" L
Material/ Color	Velcro® brand, black
UOM	25 pieces/pack

Stock ID	99000000FUT12AK
Description	Wire Management Loop Tie, 12" length
Overall Size	0.50" W x 12.0" L
Material/ Color	Velcro® brand, black
UOM	25 pieces/pack



Heavy Duty Cinch Tie

Stock ID	999119
Description	Heavy Duty Cinch Tie, 12"
Overall Size	0.75" W x 12.0" L
Material/ Color	Velcro® brand strap w/plastic buckle, black
UOM	Each

Stock ID	999120
Description	Heavy Duty Cinch Tie, 18"
Overall Size	0.75" W x 18.0" L
Material/ Color	Velcro® brand strap w/plastic buckle, black
UOM	Each

Slotted Duct Cable Management

Multilink offers both horizontal and vertical cable management products extruded from high grade polymers. All of our horizontal cable managers are produced to fit on a standard 19" rack. Our organizers ship with both the base and the cover as a set. The only color available is black. The slotted duct features open ends for ease in cable management.

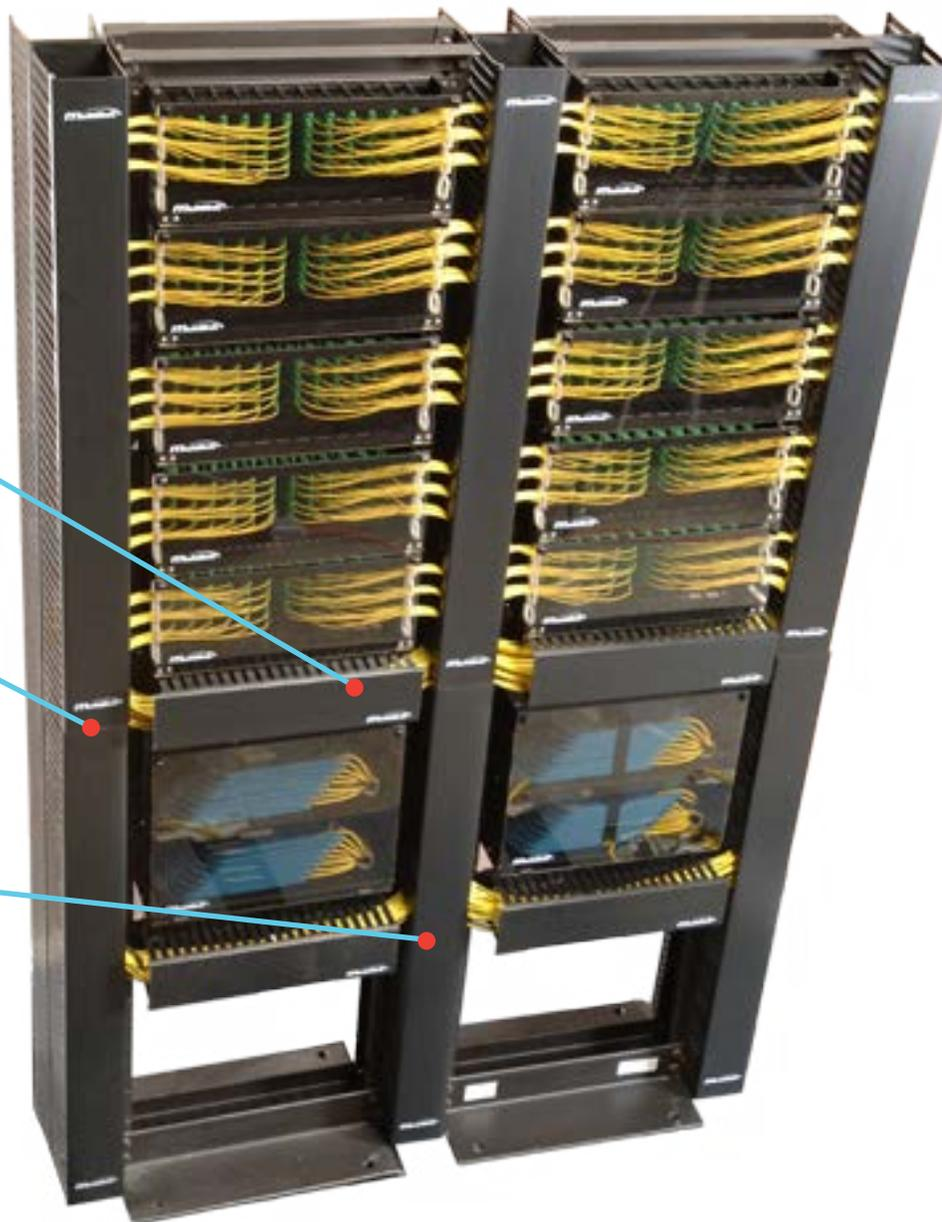

Horizontal Fiber Manager:
Features base and cover cable management on the front and backside. Brackets are featured on both ends.

Double Sided, Side Mount/ Front & Rear: Features base and cover cable management on the front and backside. Brackets are on one side only for a left or right side rack attachment.

Center Mount/Front & Rear: Features base and cover cable management on the front and backside. Brackets are on both sides of the duct for a center mount attachment between two racks.

Material	Service Temperature	Flammability	Approvals
Self extinguishing PVC	+5°F to +140°F (-15°C to +60°C)	UL94 V-0 Rated Material	UL, CSA & Lloyds Register

Slotted Duct Cable Management

Vertical Cable Managers

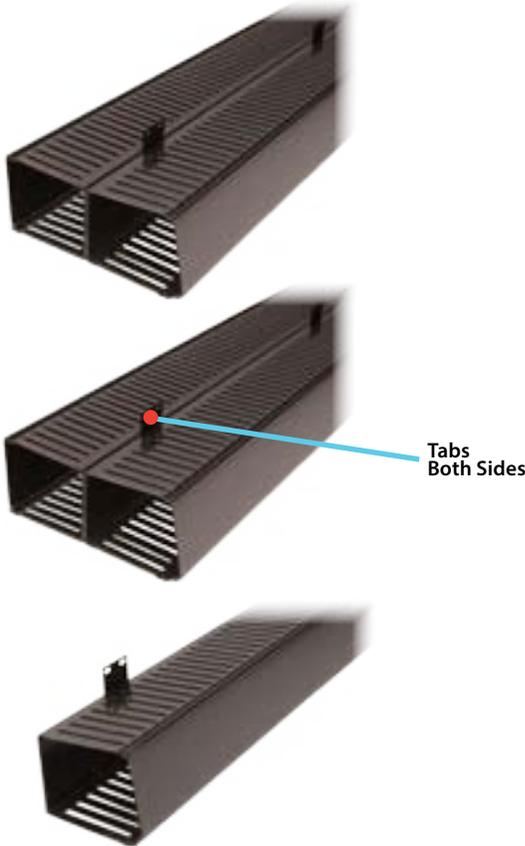

10-4154

Stock ID	10-4154
Description	Double Sided, Side Mount/Front & Rear Brackets are on one side only
Dimensions	4" W x 5" D Front & Rear, 83" H
Weight	13.0 lbs.
Material	High Grade Polymer

10-4155

Stock ID	10-4155
Description	Center Mount/Front & Rear Brackets are on both sides
Dimensions	4" W x 5" D Front & Rear, 83" H
Weight	13.0 lbs.
Material	High Grade Polymer

10-4156

Stock ID	10-4156
Description	Single Sided, Side Mount/Front Only Brackets are on one side only
Dimensions	4" W x 5" D on Front Only, 83" H
Weight	7.0 lbs.
Material	High Grade Polymer

Horizontal Cable Managers



10-4164 (1RU in height)

Stock ID	10-4164
Description	Single Sided Horizontal Cable Manager For Standard 19" Racks
Dimensions	1.5" W x 3" D Front Only
Weight	2.0 lbs.
Material	High Grade Polymer

10-4165 (1RU in height)

Stock ID	10-4165
Description	Single Sided Horizontal Cable Manager For Standard 19" Racks
Dimensions	1.5" W x 2" D Front Only
Weight	2.0 lbs.
Material	High Grade Polymer

Slotted Duct Cable Management

Horizontal Cable Managers



10-4160 (2RU in height)

Stock ID	10-4160
Description	Single Sided Horizontal Cable Manager For Standard 19" Rack
Dimensions	3" W x 3" D Front Only
Weight	3.0 lbs.
Material	High Grade Polymer



10-4158 (2RU in height)

Stock ID	10-4158
Description	Single Sided Horizontal Cable Manager For Standard 19" Rack
Dimensions	4" W x 5" D Front Only
Weight	7.0 lbs.
Material	High Grade Polymer



10-4162 (1RU in height)

Stock ID	10-4162
Description	Double Sided Horizontal Cable Manager For Standard 19" Rack
Dimensions	1.5" W x 3" D Front/1" W x 4" H Rear
Weight	5.0 lbs.
Material	High Grade Polymer



10-4163 (1RU in height)

Stock ID	10-4163
Description	Double Sided Horizontal Cable Manager For Standard 19" Rack
Dimensions	1.5" W x 2" D Front/1" W x 4" H Rear
Weight	3.5 lbs.
Material	High Grade Polymer



10-4161 (2RU in height)

Stock ID	10-4161
Description	Double Sided Horizontal Cable Manager For Standard 19" Rack
Dimensions	3" W x 3" D Front/2" W x 4" H Rear
Weight	8.0 lbs.
Material	High Grade Polymer

Slotted Duct Cable Management

Horizontal Cable Managers



10-4159 (2RU in height)

Stock ID	10-4159
Description	Double Sided Horizontal Cable Manager For Standard 19" Rack
Dimensions	3" W x 3" H Front/3" W x 5" H Rear
Weight	10.5 lbs.
Material	High Grade Polymer



10-5437 (2RU in height)

Stock ID	10-5437
Description	Double Sided Horizontal Cable Manager Brackets are on both sides
Dimensions	3" W x 3" H Front & Rear
Weight	10.0 lbs.
Material	High Grade Polymer



10-4157 (2RU in height)

Stock ID	10-4157
Description	Double Sided Horizontal Cable Manager For Standard 19" Rack
Dimensions	4" W x 5" H Front/4" W x 5" H Rear
Weight	13.0 lbs.
Material	High Grade Polymer



10-4166 (2RU in height)

Stock ID	10-4166
Description	Double Sided Horizontal Cable Manager For Standard 19" Rack with Special Strain Relief Bracket
Dimensions	3" W x 3" H Front/3" W x 5" H Rear
Weight	11 lbs.
Material	High Grade Polymer

Multilink's Family Of Splice Enclosures

STARFIGHTER™



Select the correct Starfighter Dome to meet your needs!

SFOC	XXXX	-	X	-	X	-	X	-	X	-	X
		Dome Size	Splice Tray	# Splice Trays	Mounting	# Cable Strain Relief	# Ground Lugs				
Starfighter Fiber Optic Closure	4024	4024-D (48 Single fusion)	A 612-SSTP 12 Splices	X 0-4	X P=Pole/Wall A=Aerial D=ADSS X=None	X 3-6 (3/4" Fitting)	X 0-5*				
	4048	4048-D (96 Single fusion)	B 4048-SSTP 24 Splices	X 0-4	X P=Pole/Wall A=Aerial D=ADSS X=None	X 3-6 (3/4" Fitting)	X 0-5*				
	4000	4000-D (192 Single fusion)	B 4048-SSTP 24 Splices	X 0-8	X P=Pole/Wall A=Aerial D=ADSS X=None	X 3-6 (1" Fitting)	X 0-6*				
4000-D (288 Single fusion)		C 4072-SSTP 36 Splices									

SFOC4024-A-1-A-3-1

3 is standard

*See notes

Grounding Lug Selection:

Selecting (0) grounding lugs will remove grounding braid and bonding clamps from dome.
 Selecting (1 or more) grounding lugs will include only (1) grounding braid.

4024-D Starfighter™ Dome Enclosure

The Multilink Starfighter 4024-D Fiber Optic Dome Splice closure is an “all parts” inclusive hermetically sealed splice enclosure designed for ease of assembly and re-entry. The closure is designed with a gasketed split end plate for midaccess cable applications and an easy to install “no special tool” sealing system. All major hardware is factory installed to allow for quick field installation. Universal grommets along with compression style lateral or branch cable seals, makes installing the enclosure easy. The 4024-D is a small capacity closure that can be used in aerial, pedestal, and underground applications.



Features & Benefits

- Completely sealed with compression seal technology
- Ease in installation requiring no special tools
- GR-771 and CATV industry compliant
- Mid-access design for installation over existing cables without disturbing a working cable
- Capacity: (4) 612 - SSTP - 48 Single Fusion Splices

Specifications

Exterior Closure Length	15.3" (38.9cm)
Exterior Closure Diameter	8.5" (21.59cm)
Cable Entry	(2) Express / Feeder / (4) Branch or Lateral
Express/Feeder Cable Diameter	
Max.	.75" (19mm)
Min.	.30" (7.62mm)
Branch/Lateral Cable Diameter	
Max.	.63" (16mm)
Min.	.27" (6.9mm)
Weight	6.5 lbs (3kg)
Material	Dome - Polyethylene, End Plates - Glass Filled Polypropylene, V-Band - Polypropylene

Ordering

Stock ID	Description	Dimensions	Wt. Lbs.	UOM
020-059-10	4024-D Starfighter Fiber Optic Dome Splice Enclosure with 1 Splice Tray	15.3" L x 8.5" D	6.5 lbs (3kg)	Each
065-209-10	612-SSTP Splice Tray, 12 Single/24 Ribbon Splice Capacity	6" L x 2.75" W x .75" D	0.10 lbs.	Each
10-8362	4024-D-AHK Aerial Hanger Kit	1" x 2" x 6"	2 lbs.	Pair
072-002-10	4024-D-WPK Wall or Pole Mounting Bracket/Kit	2" x 4" x 15"	2 lbs.	Each
072-002-20	4024-D-SS ADSS Mounting Kit	N/A	3 lbs.	Each
10-8181	4024-D-CAK Cable Addition Kit	N/A	1 lbs.	Each
10-7166	Compression Wrench for 3/4" NPT Fittings Aluminum	N/A	0.5 lbs.	Each

4024-D Starfighter™ Dome Enclosure

Grommet Inserts for 3/4" NPT Fittings

								
Stock ID	10-8084	10-8087	10-8085	10-8090	10-8092	10-8091	10-8088	10-9999
10 Pack ID	10-8096	10-8106	10-8097	10-8109	10-8111	10-8110	10-8107	10-5414
# of Ports	4	4	3	3	3	2	1	1
Cable Size	.20"-.24"	.16"-.20"	.24"-.28"	.16"-.20"	Flat Drop	.25"-.29"	.27"-.31"	.32"-.46"
Weight	.5 lbs.	.5 lbs.	.5 lbs.	.5 lbs.	.5 lbs.	.5 lbs.	.5 lbs.	.5 lbs.

4024-D Cable Addition Kit

10-8181

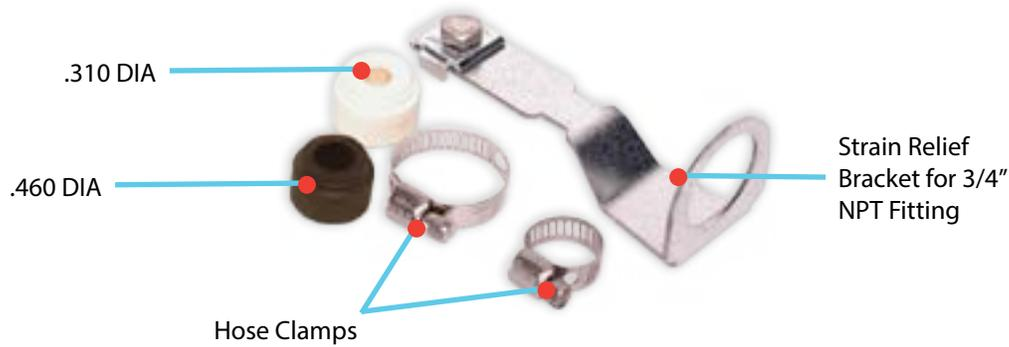

4048-D Starfighter™ Dome Enclosure



The Multilink Starfighter™ 4048D Fiber Optic Dome Splice Closure is an “all parts” inclusive hermetically sealed splice enclosure designed for ease of assembly and re-entry. The closure is designed with a gasketed split end plate for mid-access cable applications and includes an integrated slack storage basket, interlocking splice trays via a modified keyhole style stacking module, and an easy to install no special tool sealing system. All major hardware is factory installed to allow for quick field installation. Universal grommets along with compression style lateral or branch cable seals, makes installing the enclosure easy to assemble. The 4048D is a medium capacity closure that can be used in aerial, pedestal, and underground applications.

Features & Benefits

- Completely sealed with compression seal technology
- Ease in installation requiring no special tools
- GR-771 and CATV industry compliant
- Mid-access design for installation over existing cables without disturbing a working cable
- Capacity: (4) 4048 - SSTP - 96 Single Fusion Splices
- RUS Listed

Specifications

Exterior Closure Length	19.29"
Exterior Closure Diameter	8.5"
Cable Entry	(2) Express / Feeder / (4) Branch or Lateral
Express/Feeder Cable Diameter	
Max.	.75" (19mm)
Min.	.30" (7.62mm)
Branch/Lateral Cable Diameter	
Max.	.63" (16mm)
Min.	.27" (6.9mm)
Weight	7.5 lbs.
Dome	Polyethylene, End Plates - Glass Filled Polypropylene, V-Band - Polypropylene

Ordering

Stock ID	Description	Dimensions	Wt. Lbs.	UOM
10-8365	4048-D Starfighter Fiber Optic Dome Splice Enclosure w/ 1 Splice Tray	19" L x 8.5" D	7.5 lbs.	Each
020-049-10	4048-D Starfighter Fiber Optic Dome Splice Enclosure w/ Splice Tray & 6 ground lugs	19" L x 8.5" D	7.5 lbs.	Each
10-9126	4048-D Starfighter Fiber Optic Dome Splice Enclosure w/ Pedestal	40" L x 10" D	28.5 lbs.	Each
10-8007	4048-SSTP Splice Tray 24 Single/48 Ribbon Splice Capacity	9.75" L x 4.5" W x .5" D	0.57 lbs.	Each
10-8362	4048-D-AHK Aerial Hanger Kit	1" x 2" x 6"	2 lbs.	Pair
072-001-10	4048-D-WPK Wall or Pole Mounting Bracket/Kit	19"L x 1.5" W x 3.7"H	2 lbs.	Each
072-002-20	4048-D-SS ADSS Mounting Kit	N/A	3 lbs.	Each
10-8181	4048-D-CAK Cable Addition Kit	N/A	1 lbs.	Each
10-7166	Compression Wrench for 3/4" NPT Fittings Aluminum	N/A	0.5 lbs.	Each
065-058-10	4048-D Slack Rack Steel/Powder Coated, Black	N/A	0.5 lbs.	Each

4048-D Starfighter™ Dome Enclosure

Grommet Inserts for 3/4" NPT Fittings

								
Stock ID	10-8084	10-8087	10-8085	10-8090	10-8092	10-8091	10-8088	10-9999
10 Pack ID	10-8096	10-8106	10-8097	10-8109	10-8111	10-8110	10-8107	10-5414
# of Ports	4	4	3	3	3	2	1	1
Cable Size	.20"-.24"	.16"-.20"	.24"-.28"	.16"-.20"	Flat Drop	.25"-.29"	.27"-.31"	.32"-.46"
Weight	.5 lbs.	.5 lbs.	.5 lbs.	.5 lbs.	.5 lbs.	.5 lbs.	.5 lbs.	.5 lbs.

4048-D Cable Addition Kit

10-8181

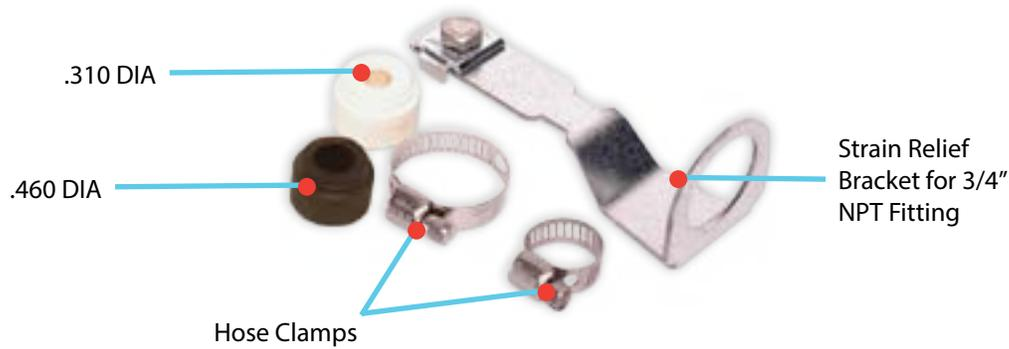



4000-D Starfighter™ Dome Enclosure

Customer Favorite

The Starfighter 4000-D Dome Splice Closure is designed for above or below grade applications and supports up to 6 or more cable entries. The closure has a unique gasketed Split End Plate system that allows for midaccessing cable up to 1.125" in diameter. Branch or lateral cables can be added to any one of four compression seal entry ports. Multiple cables (up to 6) can also be installed utilizing multi-port grommets available for the closure. The closure requires no special tools, adhesives, or mastics for installation. The new unibody slack storage basket and hinged splice trays allow for maximum storage and access of fiber and fiber bundles. Splice capacity of 288 single fusion splices using the 4072-SSTP tray 36 splice.

Features & Benefits

- Completely sealed with compression seal technology
- Ease in installation requiring no special tools
- GR-771 and CATV industry compliant
- Mid-access design for installation over existing cables without disturbing a working cable
- Can be used for above or below grade applications
- Capacity: w/ (8) 4048 - SSTP - 192 Single Fusion Splices
Capacity: w/ (8) 4072 - SSTP - 288 Single Fusion Splices
- RUS Listed

Specifications

Exterior Closure Length	24.63" (62.56cm)
Exterior Closure Diameter	11.92" (30.28cm)
Cable Entry	(2) Express / Feeder / (4) Branch or Lateral
Express/Feeder Cable Diameter Max. Min.	1.12" (28.5mm) .375" (9.5mm)
Branch/Lateral Cable Diameter Max. Min.	.98" (24.9mm) .30" (7.62mm)
Weight	12.5 lbs (5.67kg)
Material	Dome - Polyester, End Plates - Glass Filled Polypropylene, V-Band - Polypropylene

Ordering

Stock ID	Description	Dimensions	Wt. Lbs.	UOM
10-8146	4000-D Starfighter Dome Splice Enclosure w/ one 4072-SSTP Splice Tray	22.0" L x 10.0" D	12.50	Each
020-046-10	4000-D Starfighter Dome Splice Enclosure w/ one 4072-SSTP & 6 ground lugs	22.0" L x 10.0" D	N/A	Each
020-002-20	4000-D Starfighter Dome Splice Enclosure w/ one 4048-SSTP Splice Tray	22.0" L x 10.0" D	12.50	Each
10-8007	4048-SSTP 24 Fiber Splice Tray	9.75" L x 4.5" W x 0.5" D	0.57	Each
065-001-10	4072-SSTP 36 Fiber Splice Tray	10.75" L x 5.75" W x 0.5" D	0.59	Each
10-5324	4000-D-AHK Aerial Hanger Kit	1" x 2" x 6"	2 lbs.	Pair
10-5335	4000-D-WPK Wall or Pole Mounting Bracket/Kit	24"L x 2" W x 4"H	2 lbs.	Each
072-002-20	4000-D-SS ADSS Mounting Kit	N/A	3 lbs.	Each
10-6028	4000-D-CAK Cable Addition Kit	N/A	1 lbs.	Each
10-7167	Compression Wrench for 1" NPT Fittings Aluminum	N/A	0.5 lbs.	Each
10-6635	4000-D Assembly Stand	N/A	5 lbs.	Each

4000-D Starfighter™ Dome Enclosure

Interconnect Modules

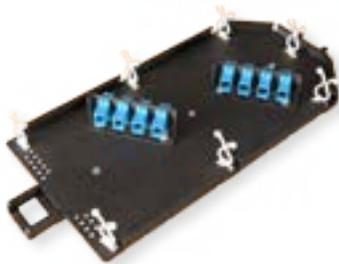

Stock ID	Description	Dimensions	Wt. Lbs.	UOM
10-6074	4000-D-4PKSCU Interconnect Module with 4 SC/UPC Bulkheads	3" x 6" x 14"	2.0	Each
10-5416	4000-D-4PKSCA Interconnect Module with 4 SC/APC Bulkheads	3" x 6" x 14"	2.0	Each
10-9164	4000-D-16PKSCU Interconnect Module with 8 SC/UPC Duplex Bulkheads (Shown) Mounts In Same	3" x 6" x 14"	2.0	Each

Grommet Inserts for 1" NPT Fittings

Stock ID	10-5552	10-5127	10-5128	10-6550	10-5129	10-6552	10-6002	10-5130	10-5134
10 Pack ID	10-5553	10-5421	10-5422	10-6551	10-5419	10-6553	10-6003	10-5483	10-5420
# of Ports	1	1	1	8	6	4	4	4	4
Cable Size	.3"- .4"	.41"- .5"	.51"- .79"	.150"	.265	.300	.350	.370	Flat Drop
Weight	.5 lbs.	.5 lbs.	.5 lbs.	.5 lbs.	.5 lbs.	.5 lbs.	.5 lbs.	.5 lbs.	.5 lbs.

4000-D Cable Addition Kit

10-6028



4000-D Wall/Pole Mount Kit

10-5335



1120-F Starfighter™ MiniButt

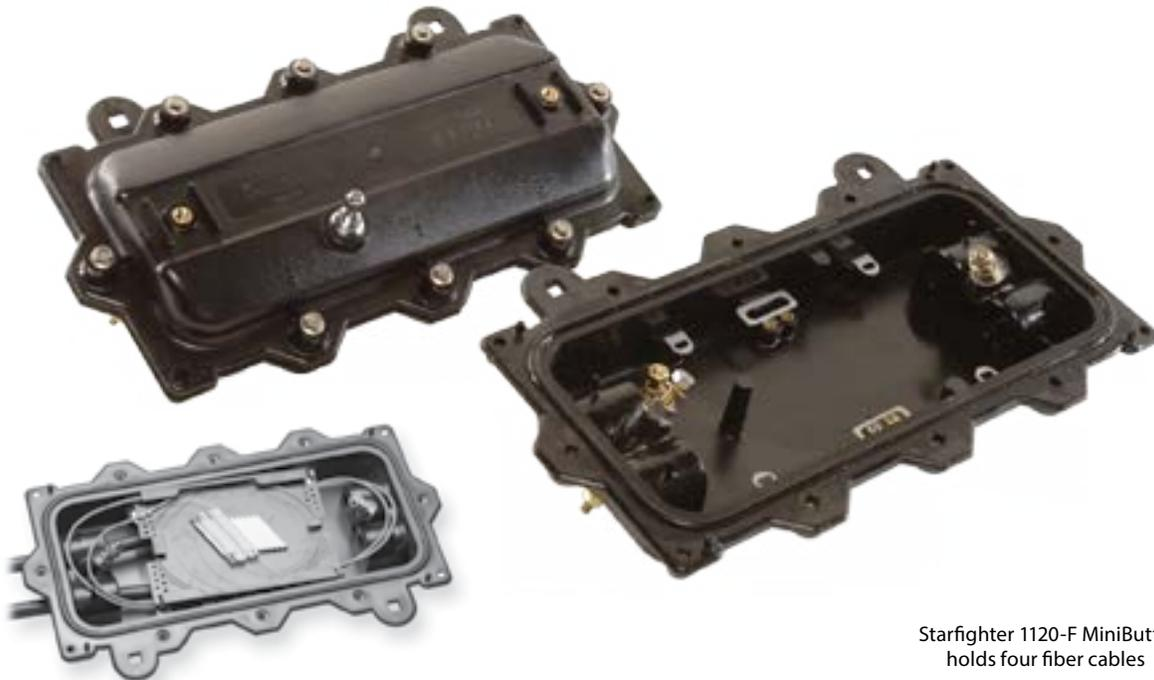

Starfighter 1120-F MiniButt™ holds four fiber cables

The 1120-F MiniButt Fiber Optic Splice Closure is designed for low count fiber splicing and in areas where space is a constraint. The closure incorporates an integrated gasket to prevent the ingress of water but to allow for ease in access.

Patent # 5732180

Features & Benefits

- Supports both Inline or Butt Configurations
- Lightweight and compact
- Up to four cable entries with cable OD range of .3" to .63"
- Suitable for above or below grade installations
- Constructed with impact and corrosion resistant materials
- Integrated "F" pressure testing valve and grounding lugs.
- Up to 24 single fusion or 48 mass fused fibers
- Equipped with all parts required for normal splicing applications
- Capacity: (2) 1120 - SSTA - 24 Single Fusion Splices
- RUS Listed

Specifications

Exterior Closure Length	15" (38.1cm)
Exterior Closure Width	6.5" (16.5cm)
Exterior Closure Height	3.5" (8.9cm)
Cable Entry	(4) Branch or Lateral
Cable Diameter	
Max.	.63" (16mm)
Min.	.3" (7.6mm)
Material	5720U Xenoy

Stock ID	Description	Dimensions	Wt. Lbs.	UOM
70203K	1120-F Starfighter Minibutt	15" L x 6.5" W x 3" D (38cm x 16.5cm x 7.6cm)	6.0	Each
70205K	1120-F Starfighter Minibutt with One 1120-SSTA Splice Tray	15" L x 6.5" W x 3" D (38cm x 16.5cm x 7.6cm)	6.35	Each
072-059-10	1120-SSTP 12 Fiber Splice Tray	6.5" L x 5.13" W x .50" D	0.20	Each

2000-F Starfighter™ Splice Closure



Starfighter 2000-F
holds four fiber cables

The Starfighter 2000-F is a medium capacity fiber optic splice closure designed for a majority of splicing applications in above and below grade installations. The closure supports both aluminum and plastic splice trays and is fully gasketed to prevent the ingress of water while allowing for ease in entry. The unit is compact and manufactured with highly impact and corrosion resistant materials.

Patent # 5732180

Features & Benefits

- Supports both Inline or Butt configurations
- Lightweight and compact
- Up to four cable entries with cable OD range of .3" to .63"
- Suitable for above or below grade installations
- Constructed with impact and corrosion resistant materials
- Integrated "F" pressure testing valve and grounding lugs
- Up to 72 single fusion or 144 mass fused fibers
- Equipped with all parts required for normal splicing applications
- Capacity: (3) 2000 - SSTA - 72 Single Fusion Splices
- Capacity: (3) 2020 - SSTA - 72 Single Fusion Splices
- RUS Listed

Specifications

Exterior Closure Length	24.5"(62.2cm)
Exterior Closure Width	8"(20.3cm)
Exterior Closure Height	5"(12.7cm)
Cable Entry	(4) Branch or Lateral
Branch/Lateral Cable Diameter	
Max.	.63" (16mm)
Min.	.3" (7.6mm)
Material	5720U Xenoy

Stock ID	Description	Dimensions	Wt. Lbs.	UOM
70304K	2000-F Starfighter	24.5" L x 8" W x 5" D (62.2cm x 20.3cm x 12.7cm)	9.0	Each
70302K	2000-F Starfighter with One 2000-SSTA Splice Tray	24.5" L x 8" W x 5" D (62.2cm x 20.3cm x 12.7cm)	9.0	Each
70506K	2000-SSTA 24 Fiber Splice Tray	11.75" L x 4" W x .5" D	.65	Each
70709K	2020-SSTP 24 Fiber Splice Tray	12.25" L x 4" W x .5" D	.54	Each

3000-F Starfighter™ Splice Closure

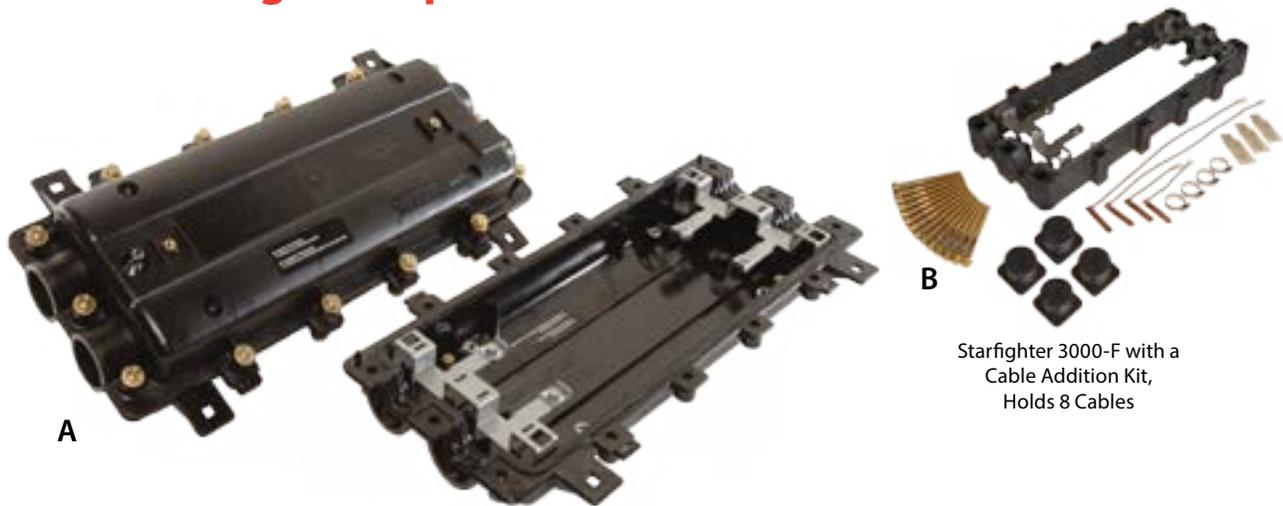

Starfighter 3000-F with a Cable Addition Kit, Holds 8 Cables

The Starfighter 3000-F is a high capacity splice closure designed for major splice points in the network. The closure supports both Inline and Butt configurations and is expandable utilizing an optional cable expansion kit. The closure utilizes gasketed sealing along with a patented cable seal which allows for mid-span access to the largest cables. The closure can be used in both above and below grade applications.

Patent # 5732180

Features & Benefits

- Mid-access cables up to 1.1" in diameter
- Supports both Inline or Butt configurations
- Up to eight cable entries with cable OD range of 0.3" to 1.1"
- Suitable for above or below grade installations
- Constructed with impact and corrosion resistant materials
- Integrated "F" pressure testing valve and grounding lugs
- Up to 288 single fusion or 576 mass fused fibers
- Equipped with all parts required for normal splicing applications
- Capacity: (6) 3000 - SSTA - 144 Single Fusion Splices
- Capacity: (6) 3030 - SSTP - 144 Single Fusion Splices
- Capacity: w/ 3000 CAK (12) - 288 Single Fusion Splices
- RUS Listed

Specifications

Exterior Closure Length	21.13" (53.66cm)
Exterior Closure Width	8.25" (20.96cm)
Exterior Closure Height	8" (20.32cm)
Cable Entry	(4) Branch or Lateral (8) with CAK
Cable Diameter	
Max.	1.124" (28.55mm)
Min.	.375" (9.525mm)
Material	5720U Xenoy

Stock ID	Description	Dimensions	Wt. Lbs.	UOM
A 70575K	3000-F Starfighter	21" L x 9.63" W x 4.5" D (53.3cm x 21.6cm x 11.4cm)	10.0	Each
- 70536K	3000-F Starfighter with 1 3000-SSTA Splice Tray (Not Pictured)	21" L x 9.63" W x 4.5" D (53.3cm x 21.6cm x 11.4cm)	11.0	Each
- 70582K	3000-F Starfighter with 1 3030-SSTP Splice Tray (Not Pictured)	21" L x 9.63" W x 4.5" D (53.3cm x 21.6cm x 11.4cm)	11.0	Each
B 70314K	3000-CAK (Cable Addition Kit) Starfighter	21" L x 9.38" W x 3" D (53.3cm x 23.83cm x 7.62cm)	8.0	Each
- 70505K	3000-SSTA 24 Fiber Splice Tray	7.75" L x 6" W x .5" D	1.0	Each
- 70706K	3030-SSTP 24 Fiber Splice Tray	8.25" L x 5.75" W x .5" D	1.0	Each

Splice Closure Accessories



1100-A Aerial Hanger Brackets

Stock ID	70800K
Description	1100-A Aerial Hanger Brackets
Weight	.66 lbs
Material	Stainless Steel
UOM	Pair



1100-SS ADSS Mounting Kit

Stock ID	71241K
Description	1100-SS ADSS Mounting Kit
Weight	.55 lbs.
Material	Plastic/Stainless Steel
UOM	Each



1100-W Wall/Pole Mounting Brackets

Stock ID	70307K
Description	1100-W Wall/Pole Mounting Brackets
Weight	.35 lbs
Material	Galvanized Steel
UOM	Pair



1100-T Standard Tap Bracket

Stock ID	70653
Description	1100-T Standard Tap Bracket
Weight	.19 lbs
Material	Aluminum
UOM	Each

Starfighter™ Optical Terminal Enclosure

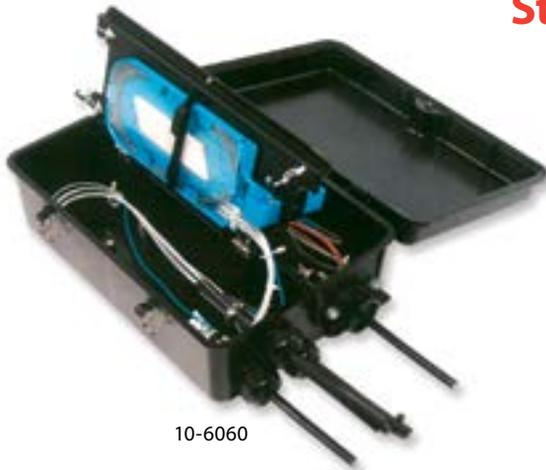

10-6060



020-066-10

The OTE (Optical Terminal Enclosure) is designed to support the splicing of optical drops and traditional splicing in aerial, pole, or wall mount applications. The unit is an inline enclosure with four ports on each end. The OTE is constructed of a durable and impact resistant polyethylene material specifically formulated for outside plant environments. The unit can support express cabling as well as the addition of branch or lateral cabling. When used as a drop splicing enclosure, the OTE will support a variety of drop designs and provide the environmental sealing and strain relief required. Up to 36 drops can be supported in FTTH applications. The enclosure is supplied with all of the hardware required to seal and secure the express/feeder cables, and a (12) fiber splice tray.

Features & Benefits

- Easy to assemble cable sealing and retention system.
- Reduces operating costs by allowing customers to purchase additional capacity only when needed.
- Reduces closure inventory. The enclosure is suitable for a wide variety of above grade installation and mounting applications.
- Universal above grade optical fiber splicing and termination capability.
- High impact resistant and UV resistant thermoplastic for long life.
- Supports PON components as well as optical connectorized terminations.
- Provides all in one sealing and strain relief of individual drops.
- Can support up to 36 individual drops.
- Mid-access capable for cables up to 1.125" in diameter.

Specifications

Exterior Closure Length	18.5"	Standard Splice Trays	4 (Enclosure comes equipped with 1 Tray)
Exterior Closure Depth	6.0"	Standard Cables	2 (Express Feeder)
Exterior Closure Height	11.5"	FTTH/Lateral Ports	6 Ports (Up to 36 Individual Drops)
Cable Entry Ports	(2) Express Feeder, (6) Branch Lateral, or Multiport*	Standard Single Splices	48
Express/Feeder Cable Diameter	Max. 1.124"/Min. 0.375"	Branch/Lateral Cable Diameter	Max. 0.98"/Min. 0.30"

Drop Seals or other cable seal kits, see ordering information

*Multiport Cable Seals are available to support up to 36 fiber drops for FTTH Applications

Ordering

Stock ID	Description	Dimensions	Weight	UOM
10-6060	Starfighter OTE Optical Termination Enclosure (Basic Enclosure)	18.5" L x 11.5" W x 6" D	10 lbs.	Each
020-026-20	Starfighter OTE Optical Termination Enclosure w/ 6 Scout Adapters	18.5" L x 11.5" W x 6" D	12 lbs.	Each
020-066-10	Starfighter OTE Optical Termination Enclosure w/ 8 SC/APC Adapters	18.5" L x 11.5" W x 6" D	12 lbs.	Each
10-8007	4048-SSTP 24 Fiber Splice Tray	9.75" L x 4.5" W x 0.5" D	0.57 lbs.	Each
10-5435	Wall/Pole Mounting Bracket w/ Mounting Hardware	N/A	3 lbs.	Each
10-5436	Aerial Hanger Bracket Kit	N/A	N/A	Pair
10-5434	ADSS Mounting Bracket	N/A	N/A	Each

OTE Additional Options

Grommet Inserts For 1" NPT Fittings

Stock ID	10-5552	10-5127	10-5128	10-6550	10-5129	10-6552	10-6002	10-5130	10-5134	065-082-10
10 Pack ID	10-5553	10-5421	10-5422	10-6551	10-5419	10-6553	10-6003	10-5483	10-5420	N/A
# of Ports	1	1	1	8	6	4	4	4	4	1-SC
Cable Size	.3"-.4"	.41"-.5"	.51"-.79"	.150"	.265	.300	.350	.370	Flat Drop	SC Outdoor
Weight	.5 lbs.	.5 lbs.	.5 lbs.	.5 lbs.	.5 lbs.	.5 lbs.	.5 lbs.	.5 lbs.	.5 lbs.	.2 lbs.



1" NPT Dome Fitting

Stock ID	10-5122
Description	1" NPT Dome Fitting-Includes. Insert for
Dimensions	.71"- .98" Diameter Cable
Material	Plastic
UOM	Each

OTE Cable Addition Kit

Stock ID	065-016-10
Description	OTE Cable Addition Kit for Branch or Lateral Cable Additions, .3"-.98"
UOM	Each

Splice Trays

All of the Multilink splice trays are universal to the industry. These trays are compatible with all of our enclosures. The splice trays provide protection and organization of fiber splices. Adhesive backed fiber insert holders and assorted cable ties included (grommets included on the 3030-SSTP).



1120-SSTA

X1

Stock ID	70902K
Model #	1120-SSTA
Description	12 Single Fusion Splice Tray
Dimensions	6.5" L x 4.75" W x .5" D
Weight	Approx. 0.35 lbs.
Material	Aluminum
Capacity	12 Single Fusion Splices



2000-SSTA

X2

Stock ID	70506K
Model #	2000-SSTA
Description	24 Single Fusion Splice Tray
Dimensions	11.75" L x 4" W x .5" D
Weight	Approx. 0.65 lbs.
Material	Aluminum
Capacity	24 Single Fusion Splices, 16 Mechanical Splices, or 96 Mass Fusion Splices



3000-SSTA

X6

Stock ID	70505K
Model #	3000-SSTA
Description	24 Single Fusion Splice Tray
Dimensions	7.75" L x 6" W x .5" D
Weight	Approx. 0.54 lbs.
Material	Aluminum
Capacity	24 Single Fusion Splices, 16 Mechanical Splices, or 96 Mass Fusion Splices



2020-SSTP

X3

Stock ID	70709K
Model #	2020-SSTP
Description	24 Single Fusion Splice Tray
Dimensions	12.25" L x 4" W x .5" D
Weight	Approx. 0.54 lbs.
Material	Plastic Base w/ Aluminum Cover
Capacity	24 Single Fusion Splices, 16 Mechanical Splices, or 96 Mass Fusion Splices

Splice Trays

All of the Multilink splice trays are universal to the industry. These trays are compatible with all of our enclosures. The splice trays provide protection and organization of fiber splices. Adhesive backed fiber insert holders and assorted cable ties included (grommets included on the 3030-SSTP).



612-SSTP

X8

Stock ID	065-209-10
Model #	612-SSTP
Description	12 Single Fusion Splice Tray
Dimensions	6" L x 2.75" W x .75" D
Weight	Approx. 0.10 lbs.
Material	Plastic
Capacity	12 Single Fusion Splices Only 40mm Splice Sleeve Only



1120-SSTP

X9

Stock ID	072-059-10
Model #	1120-SSTP
Description	12 Single Fusion Splice Tray
Dimensions	6.5" L x 5.13" W x 0.5" D
Weight	Approx. 0.20 lbs.
Material	Plastic
Capacity	12 Single Fusion Splices Only 40mm Splice Sleeve Only

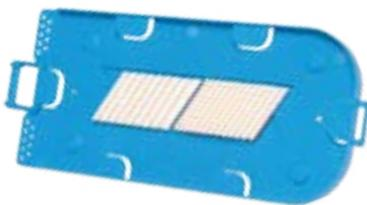

4048-SSTP

X4

Stock ID	10-8007
Model #	4048-SSTP
Description	24 Single Fusion Splice Tray
Dimensions	9.75" L x 4.5" W x .5" D
Weight	Approx. 0.60 lbs.
Material	Plastic
Capacity	24 Single Fusion Splices (48 Dual Stacked), 16 Mechanical Splices, or 96 Mass Fusion Splices



4072-SSTP

X5

Stock ID	065-001-10
Model #	4072-SSTP
Description	36 Single Fusion Splice Tray
Dimensions	10.75" L x 5.75" W x .5" D
Weight	Approx. 0.60 lbs.
Material	Plastic
Capacity	36 Single Fusion Splices (72 Dual Stacked), 24 Mechanical Splices, or 144 Mass Fusion Splices

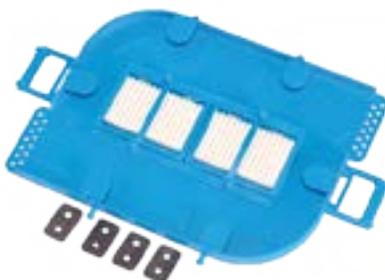

3030-SSTP

X7

Stock ID	70706K
Model #	3030-SSTP
Description	24 Single Fusion Splice Tray
Dimensions	8.25" L x 5.75" W x .5" D
Weight	Approx. 0.50 lbs.
Material	Plastic
Capacity	24 Single Fusion Splices, 16 Mechanical Splices, or 96 Mass Fusion Splices

3015-MSGK Mid-Span Grounding/Bonding Enclosure



The Starfighter Mid-Span Grounding Closure is specifically designed to allow for meeting grounding and bonding specifications. The closure has a Gel Seal technology to provide for a water tight seal without the need for any additional grommets or special seals. The closure is also designed for re-sealing cable sheath damaged as a result of placing or outside plant events.

Features & Benefits

- Completely sealed with Gel Seal technology.
- Ease in installation requiring no special tools.
- Compact for tight areas.
- Mid-access design for installation over existing cables without disturbing a working cable.
- Can be used for above or below grade applications.

Stock ID	Description	Dimensions	Weight Lbs.	UOM
313015MS6K	3015-MSGK Mid-Span Grounding Bonding Enclosure	12"L x 2.38"D	1.86	Each

Slack Storage Devices - Plastic Sno-Shoe®, Fiber Optic Storage, Aerial and Vault

The Multilink Plastic Sno-Shoe® has been designed with two purposes in mind. The first is to store additional lengths of fiber along the strand for later use. The second is to act as a safeguard, protecting the minimum bend radius of the fiber optic cable while establishing proper installation practices. The Multilink Plastic Sno-Shoe® is a durable and cost effective tool for storing fiber optic cable in the air!

Benefits

Why use the Plastic Adjustable Sno-Shoe®?

- Prevents microbends in fiber optic cable
- Provides consistency and regularity in fiber optic loops
- Solution to spacing problems on poles
- 20 year pro-rated warranty

Features

- The plastic material design makes the Sno-Shoe® non-conductive.
- Countersunk nut wells for easy one tool installation.
- The captive design of the Patented Cable Trough™ allows the installer to simply lay the cable in the trough, leaving both hands free to secure the cable to the unit.
- Stackability: the Plastic Adjustable Sno-Shoe® can be stacked in multiple cable configurations to accommodate additional fiber mount tiering.
- The multiple slots in the Patented Cable Trough™ allow you to secure the cable with either heavy duty tie wraps or stainless steel straps. These slots also allow you to secure additional cable to the unit in expansion situations without having to remove any of the previously installed cable from the unit and also allows for water and ice drainage.

Rule of Thumb

When selecting the Sno Shoe to best fit your application:

20 x Fiber Radius = Sno Shoe Size*

**Always consult your fiber manufacturer to determine your minimum bend radius*



Strand Mount



ADSS Mount



Slack Storage Devices



7" PLASTIC SNO-SHOE® W/MOUNTING BRACKET & HARDWARE

Stock ID	Model #	Mounting Kit	Channel Length	Channel Width	Channel Depth	MOQ
649-011-20	VASSB	Strand	22"	1.75"	1.0"	1 pc
649-011-10	VASSB	None	22"	1.75"	1.0"	1 pc
Overall Size		Weight Each	Bend Radius	Boxed Qty	Boxed Weight	
13.0"L x 11.0"W x 1.6"D		1.0 Lbs	3.5"	1	1.4 Lbs	



10" PLASTIC SNO-SHOE® W/MOUNTING BRACKET & HARDWARE

Stock ID	Model #	Mounting Kit	Channel Length	Channel Width	Channel Depth	MOQ
71211K	2110-SSPTB	Strand	52"	1.0"	1.0"	2 pcs
71220K	2110-SSPSS	ADSS	52"	1.0"	1.0"	2 pcs
Overall Size		Weight Each	Bend Radius	Boxed Qty	Boxed Weight	
23.8"L x 12.3"W x 1.1"D		1.4 Lbs	5"	2	3.5 Lbs	



16" PLASTIC SNO-SHOE® W/MOUNTING BRACKET & HARDWARE

Stock ID	Model #	Mounting Kit	Channel Length	Channel Width	Channel Depth	MOQ
71244K	2116-SSPTB	Strand	59"	1.0"	1.25"	2 pcs
71215K	2116-SSPSS	ADSS	59"	1.0"	1.25"	2 pcs
Overall Size		Weight Each	Bend Radius	Boxed Qty	Boxed Weight	
24.0"L x 18.0"W x 1.5"D		1.7 Lbs	8"	2	4.4 Lbs	



Customer Favorite



21" PLASTIC SNO-SHOE® W/MOUNTING BRACKET & HARDWARE

Stock ID	Model #	Mounting Kit	Channel Length	Channel Width	Channel Depth	MOQ
71221K	2121-SSPTB	Strand	80"	2.0"	1.75"	1 pc
71226K	2121-SSPSS	ADSS	80"	2.0"	1.75"	1 pc
Overall Size		Weight Each	Bend Radius	Boxed Qty	Boxed Weight	
33.0"L x 25.3"W x 2.0"D		4.8 Lbs	11.5"	1	6.7 Lbs	



STACKING KIT FOR PLASTIC SNO-SHOE®

Stock ID	Kit Includes	Weight	MOQ
71301K	(2) Risers, (2) Bolts, (2) Washers, (2) Nuts	2 Lbs	1 Kit

Slack Storage Devices



16" Sno-Shoe shown with Strand Mounting Bracket fully open

16" PLASTIC ADJUSTABLE SNO-SHOE®

Stock ID	Model #	Mounting Kit	Channel Length	Channel Width	Channel Depth	MOQ
71255K	2116-SAPTBS	Strand	50"-62"	2.0"	2.0"	1 pc
71240K*	2116-SAPTBP	Pole w/Strut	50"-62"	2.0"	2.0"	1 pc
71236K	2116-SAPTBW	Wall	50"-62"	2.0"	2.0"	1 pc
71239K	2116-SAPTBR	Rack	50"-62"	2.0"	2.0"	1 pc
71225K	2116-SAPSS	ADSS	50"-62"	2.0"	2.0"	1 pc
Overall Size		Weight Each	Boxed Qty	Bend Radius	Boxed Weight	
24.5"L x 20.5"W x 2.3"D		5.1 Lbs*	1	8"	6.0 Lbs	

*71240K includes 6ft unistrut. Add 10 lbs.



24" Sno-Shoe shown with Strand Mounting Bracket fully open

24" PLASTIC ADJUSTABLE SNO-SHOE®

Stock ID	Model #	Mounting Kit	Channel Length	Channel Width	Channel Depth	MOQ
71258K	2124-SAPTBS	Strand	75"-87"	2.25"	.88"	1 pc
71261K*	2124-SAPTBP	Pole w/Strut	75"-87"	2.25"	.88"	1 pc
71263K	2124-SAPTBW	Wall	75"-87"	2.25"	.88"	1 pc
Overall Size		Weight Each	Boxed Qty	Bend Radius	Boxed Weight	
36.8"L x 28.8"W x 2.0"D		9.6 Lbs*	1	8"	11.4 Lbs	

*71261K includes 6ft unistrut. Add 10 lbs.



EXTENSIONS FOR ADJUSTABLE SNO-SHOES®

Stock ID	Kit Includes	MOQ
10-7168	(2) 18" Extensions & (2) Hardware Kits	1 Kit
10-7169	(2) 48" Extensions & (2) Hardware Kits	1 Kit



Stock ID	Description	Dimensions	Color	UOM
10-4653	Slack Box SSB-303612	30" x 36" x 12"	Gray	Each
10-4666	Slack Box SSB-364212	36" x 42" x 12"	Gray	Each

MULTITAG™ Tamper Resistant Security Seals

The Multilink, Inc. MULTITAG™ was designed with the installer's problems and needs in mind. The uniquely patented design surrounds the cable with both the body and hasp, making the tag virtually tamperproof!

Customer Favorite



Get Your Custom Logo Engraved On Your Tags!



MT -
 -
 -
 -

MULTILINK TAG
 OPTION 1
 OPTION 2
 TAG COLOR
 WIRE TYPE

Identification Options

PO*	Plain
LW*	Large Writing Panel
BA*	Barcode w/Alphanumerical (5,000 MOQ)
A	7 Digit Alphanumerical
N	Custom Name
L	Custom Logo
W	Writing Panel
O	Denotes No Second Option Desired

*Second option not available

Color Options

01	Yellow	09	Lt. Blue
02	Orange	10	Dk. Blue
03	Purple	11	Lt. Green
04	Gold	12	Dk. Green
05	White	13	Blue Gray
06	Black	14	Rose
07	Red	15	Beige

Other custom colors available upon request

Wire Options

A	Standard
B	Loop

Standard Package is 100 pieces per bag

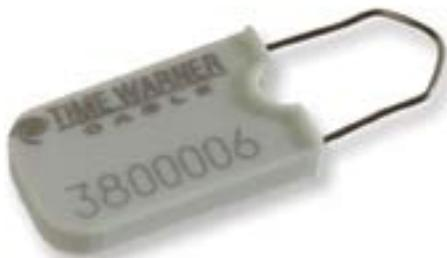

MT-AL
7 Digit Alphanumerical w/Custom Logo



MT-WN
Writing Panel w/Custom Name

Please specify which loop style you prefer when placing your order.

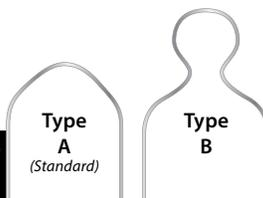

MULTITAG™ Tamper Resistant Security Seals



MT-LO
Custom Logo



MT-WL
Writing Panel w/Custom Logo

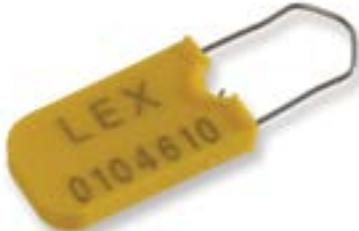

MT-AN
7 Digit Alphanumerical w/Custom Name



MT-WA
Writing Panel, w/7 Digit Alphanumerical



MT-AO
7 Digit, Alphanumerical



MT-PO
Plain



MT-WO
Writing Panel

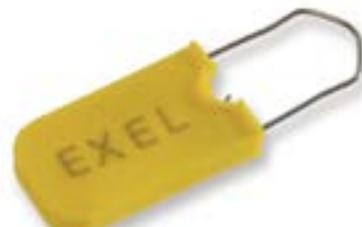

MT-NO
Custom Name



MT-LW
Large Writing Panel



MT-BA
Bar Code w/7 Digit Alphanumerical
(Minimum Order of 5,000 pieces)
Bar Code your Multilink, Inc. MULTITAG™ and get a second set of bar codes to stick on the audit work sheet report!

Cable Markers

MFM Series Lasered Fiber Optic Cable Marker UV Stabilized Body for Weather and Color

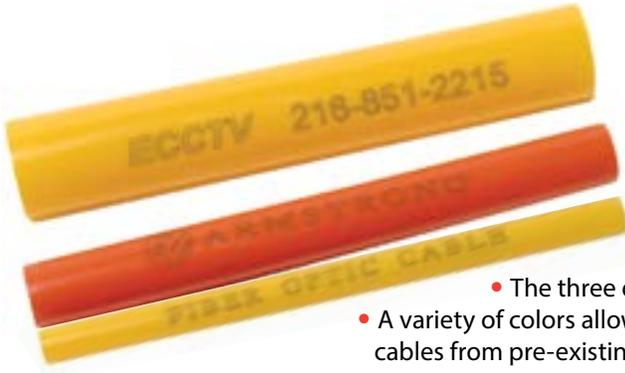

Features & Benefits

- Lifetime warranty on printing and a 20 year pro-rated warranty on plastic body
- Customization provides easy identification of your cables during emergencies or general maintenance
- UV stabilized body won't degrade in outside applications
- Simple and quick installation: Wrap-around design eliminates the need for special tools and adhesives.
- The three different sizes can accommodate a variety of cable configurations
- A variety of colors allow you to segregate your different fiber runs or to distinguish your cables from pre-existing cables

Ordering Information

MFM	-		-		-																															
MULTILINK FIBER MARKER		MARKER DIAMETER SIZE		CUSTOM MARKER OPTIONS		MARKER COLOR OPTIONS																														
		<table border="1"> <tr><td>12</td><td>.5" x 8"</td></tr> <tr><td>15</td><td>1" x 8"</td></tr> <tr><td>20</td><td>2" x 8"</td></tr> </table> <p><small>*Other custom lengths available upon request</small></p>	12	.5" x 8"	15	1" x 8"	20	2" x 8"		<table border="1"> <tr><td>00</td><td>Lasered "Fiber Optic Cable"</td></tr> <tr><td>RT</td><td>Custom Text</td></tr> <tr><td>SL</td><td>Special Logo</td></tr> </table>	00	Lasered "Fiber Optic Cable"	RT	Custom Text	SL	Special Logo		<p>Standard Colors</p> <table border="1"> <tr><td>01</td><td>Yellow</td></tr> <tr><td>02</td><td>Orange</td></tr> <tr><td colspan="2">Custom Colors</td></tr> <tr><td>03</td><td>Blue</td></tr> <tr><td>04</td><td>Green</td></tr> <tr><td>05</td><td>Gray</td></tr> <tr><td>06</td><td>White</td></tr> <tr><td>07</td><td>Brown</td></tr> <tr><td>08</td><td>Red</td></tr> </table> <p><small>*Other custom colors available upon request</small></p>	01	Yellow	02	Orange	Custom Colors		03	Blue	04	Green	05	Gray	06	White	07	Brown	08	Red
12	.5" x 8"																																			
15	1" x 8"																																			
20	2" x 8"																																			
00	Lasered "Fiber Optic Cable"																																			
RT	Custom Text																																			
SL	Special Logo																																			
01	Yellow																																			
02	Orange																																			
Custom Colors																																				
03	Blue																																			
04	Green																																			
05	Gray																																			
06	White																																			
07	Brown																																			
08	Red																																			

- MFM Flag style markers available for 1" cable.
- Same great features with added space for custom identification.
- Marker length is custom to request.
- Contact customer service for more information.



500 Minimum Order with both RT & SL part numbers
 5,000 Minimum Order for custom colors
 Please contact customer service for custom orders and more information
 Please note: \$75.00 one time set-up fee for special logo

Specifications subject to change without notice.

© Multilink, Inc. 2013 • All Rights Reserved

Environmentally Controlled, Forced Convection & Natural Convection



SmartPed 2000-FNC



Applications

An above-ground housing to shelter amplifiers, splice enclosures, nodes, and provide ample space for slack storage in a secured environment.

Features & Benefits

- Pedestal consists of one piece continuous frame made up of galvanealed steel and a top, four doors and skirts made up of galvanealed steel
- Pedestal parts are coated with 2-3 mils of polyester powder coat after undergoing 5 pretreatment processes
- All four doors and top are detachable using stainless steel slide off hinges (8)
- Front doors are locked with a rod-roller system including a flush mounted 1 piece lock
- Back doors are also locked internally and can only be accessed from inside the pedestal
- All door ventilation louvers are backed with fiberglass bug screens
- Convection air flow system in place to properly ventilate cabinet
- Pedestal can either be concrete pad mounted, stake mounted, or vault mounted
- All vertical seams are sealed with synthetic rubber seal, entire cabinet is rain tight
- Built-in universal mounting hardware and accessories made of galvaneal with polyester powder coat to withstand all environments.
- Safety Corners™

Construction

Main Body	Galvannaed Steel / Safety Corners All Vertical Seams Sealed w/ Synthetic Rubber Seal
Hardware	Stainless Steel
Finish	Polyester Powder Coat
Capacity	Ample Space To Mount Amplifiers, Splice Closures, Nodes And Slack Storage

Door	Front Dual Doors, 3 Point Latch, Lockable Back Dual Doors, Locked From Inside All Doors Removable Detachable Top
Cable Entrance	Bottom Open For Concrete Pad, Or Vault Mounting
Heating and Cooling	Natural Convection All Door Louvered Top, Bottom And Back w/ Bug Screen

Part#	Description	Dimensions	UOM
12467K	2000-FNC Node Cabinet and Pedestal Base, includes two mounting rods and slack storage brackets	50"H x 30"W x 16"D	Each
12824	BS-24 Stake	24" L	Each
12432	BS-32 Stake	32" L	Each
12845	BS-42 Stake	42" L	Each

Customize internal SmartPed components to fit your broadband needs. Call Customer Service for more information. (440.366.6966)



Wall/Pole Mount 6RU



Internal equipment not included.

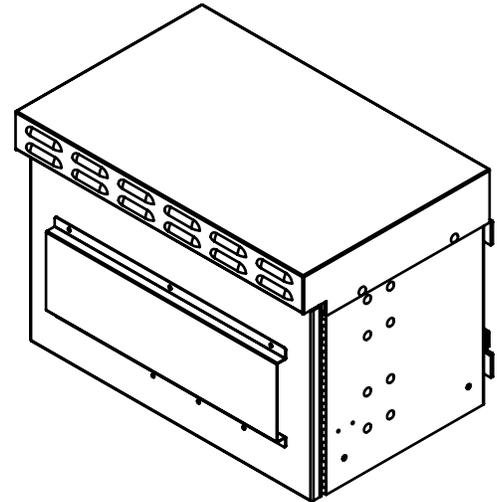
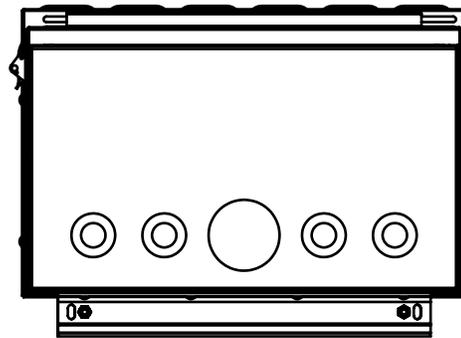
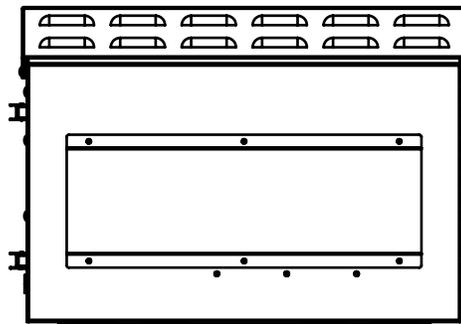
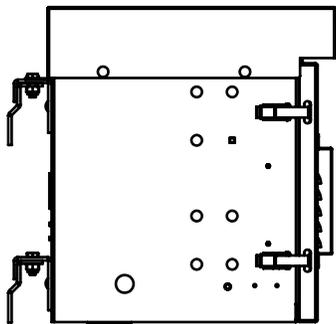

Construction

Main Body	1/8" Aluminum
Hardware	Stainless Steel
Finish	Polyester Powder Coat
Rack	19"-Width 6RU Height 10-32 Threads EIA/TIA Spacing
Door	Padlockable Draw-Latch, Piano Hinge, Wind Stop

Cable Entrance	(4) Dual-Stage Knockouts 1.4-2.5" on Bottom (1) Single Stage Knockout 4" on Bottom (1) Single Stage Knockout 2" on Back (1) Single Stage Knockout 1" on Left Side
Heating and Cooling	Dual 100 CFM 48V DC Fans Door and Roof Louvers Backed w/ Screen
Grounding	Copper Bus Bar, Ground Lug
Mounting	Wall or Unistrut Mount
Powering	DC Wiring

Stock ID	Description	Dimensions	Color	Wt. Lbs.	UOM
030-251-30	Wall/Unistrut Mount 6RU	17.9" H x 25.7" W x 18.6"D	Beige	68	Each

Specifications subject to change without notice.

© Multilink, Inc. 2013 • All Rights Reserved

Wall/Pole Mount 21RU

Customer Favorite

Customer Favorite

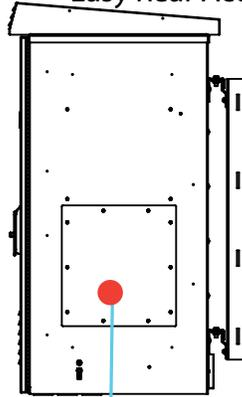
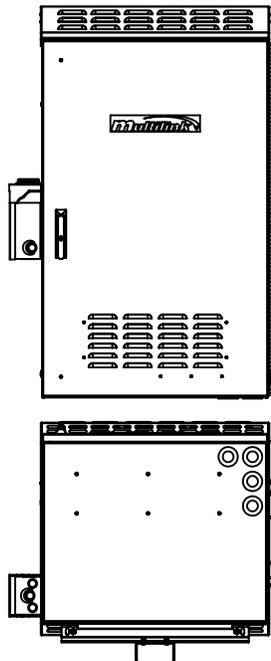
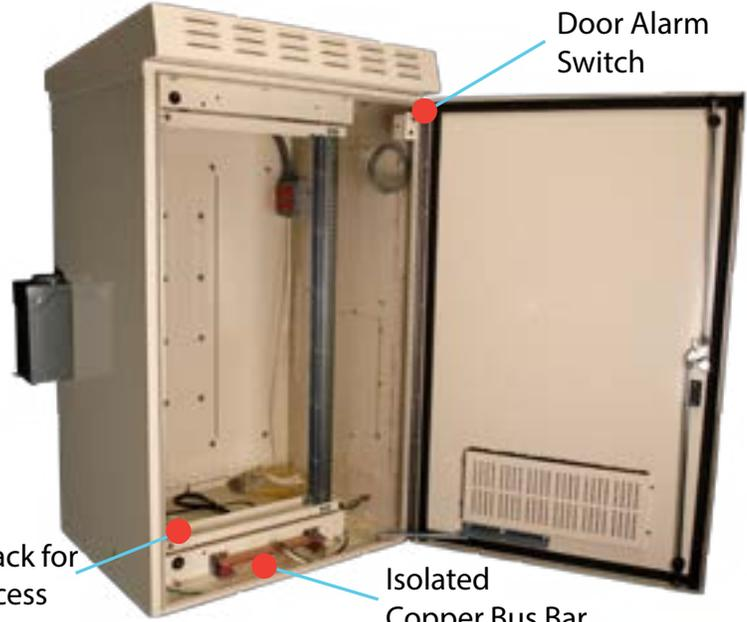

Removable Panel for Optional Heat Exchanger

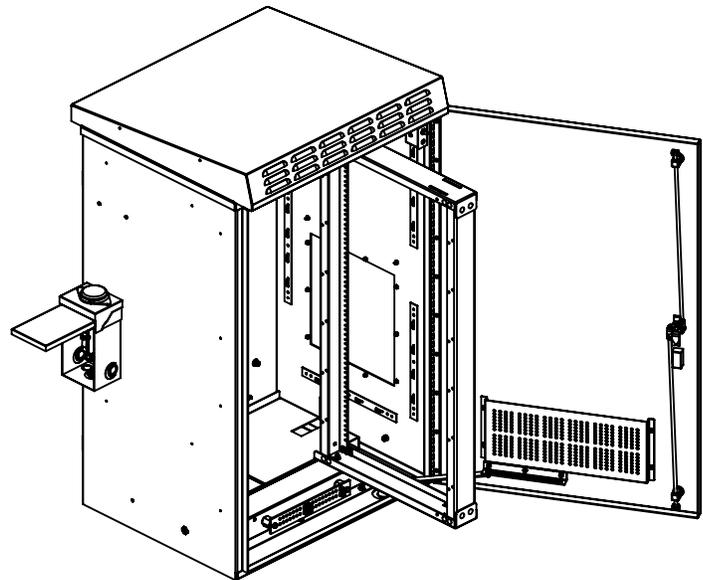

Construction

Main Body	1/8" Aluminum
Hardware	Stainless Steel
Finish	Polyester Powder Coat
Rack	19"-Width, Swingout 21RU Height 10-32 Threads EIA/TIA Spacing
Door	3 Point Latch, Piano Hinge, Wind Stop

Cable Entrance	(4) Dual Stage Knockouts 1-3", Located Front Right of the Cabinet
Heating and Cooling	Can Include A/C or Heat Exchanger
Grounding	All Components Are Grounded To The Main Bus Bar
Mounting	Wall or Pole Mount
Powering	120/240VAC Service Entrance, 20 Amp Circuit Breaker, Surge Protector, (2) Duplex Receptacle, 125V, 20A Ground Bar

Stock ID	Description	Dimensions	Color	Wt. Lbs.	UOM
030-202-10	Wall/Unistrut Mount 21RU	50" H x 29" W x 24"D	Beige	210	Each
030-202-40	Pole Mount 21RU	50" H x 29" W x 24"D	Beige	210	Each

Specifications subject to change without notice.

© Multilink, Inc. 2013 • All Rights Reserved



Wall Mount 5RU

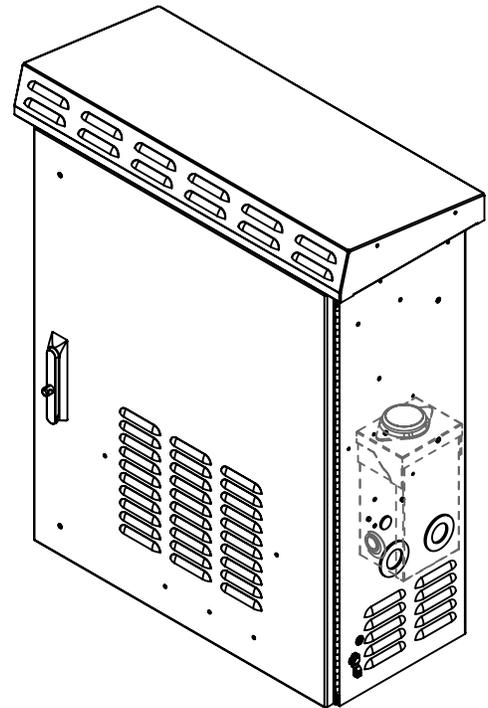
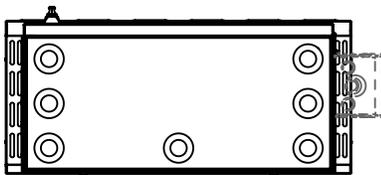
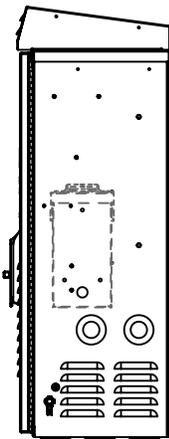
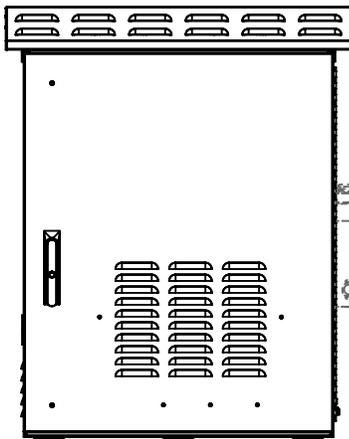

Construction

Main Body	1/8" Aluminum
Hardware	Stainless Steel
Finish	Polyester Powder Coat
Rack	19"-Width, Swingout 5RU Height 10-32 Threads EIA/TIA Spacing
Door	3 Point Latch, Piano Hinge

Cable Entrance	(2) Dual Stage Knockouts 1.38-2.47" Ea. Side (7) Dual Stage Knockouts 1.38-2.47" Bottom
Heating and Cooling	Dual 100CFM Fans
Grounding	All Components Are Grounded To The Main Bus Bar
Mounting	Wall Mount
Powering (-30 only)	70Amp-120VAC Service Entrance, 20 Amp Circuit Breaker, Surge Protector, (2) Duplex Receptacle, 125V, 20A Ground Bar

Stock ID	Description	Dimensions	Color	Wt. Lbs.	UOM
030-264-10	5RU Enclosure w/ Vertical Swing Out Rack	36.12" H x 29" W x 14"D	Beige	80	Each
030-264-20	5RU Enclosure w/ Vertical Swing Out Rack and Service Ent.	36.12" H x 31.7" W x 14"D	Beige	85	Each

Specifications subject to change without notice.

© Multilink, Inc. 2013 • All Rights Reserved

Backhaul 12RU

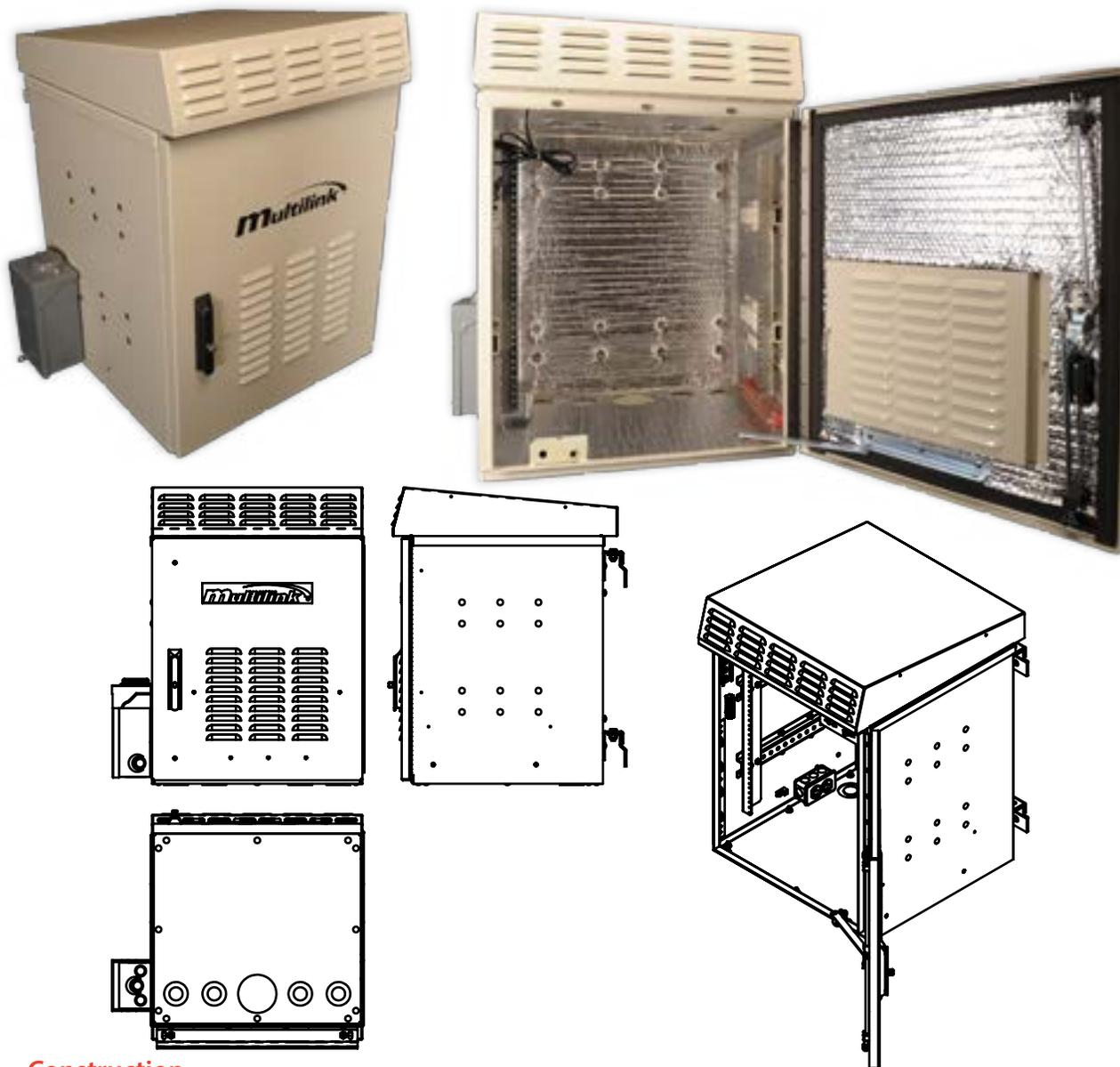

Construction

Main Body	Aluminum
Hardware	Stainless Steel
Finish	Polyester Powder Coat
Rack	19" Width 12RU Height 10-32 Threads EIA/TIA
Door	3 Point Latch, Piano Hinge, Wind Stop

Heating & Cooling	Dual thermostatically controlled, 48V DC, 100CFM fans with patented lifesaver roof
Mounting	Wall/Unistrut
Powering	125V Duplex Receptacle w/Service Entrance
Cable Entrance	4 X(Ø1.5 X 2.25") Dual Stage Knockouts 1 X(Ø4.00") Single Stage Knockout

Stock ID	Description	Dimensions	Color	Wt. Lbs.	UOM
030-180-40	12RU Wall/Unistrut Mount (configured as shown)	31" H x 26" W x 23.5" D	Beige	87	Each
030-180-60	12RU Pole Mount (configured as shown)	31" H x 26" W x 26.2" D	Beige	93	Each
030-180-25	12RU Wall/Unistrut Mount (w/o service entrance, fused 48V DC Fans)	31" H x 22" W x 23.5" D	Beige	85	Each
745-560-P1	12" Ground Mount Pedestal	12" H x 20.14" W x 22" D	Beige	-	Each



Backhaul 12RU w/Heat Exchanger

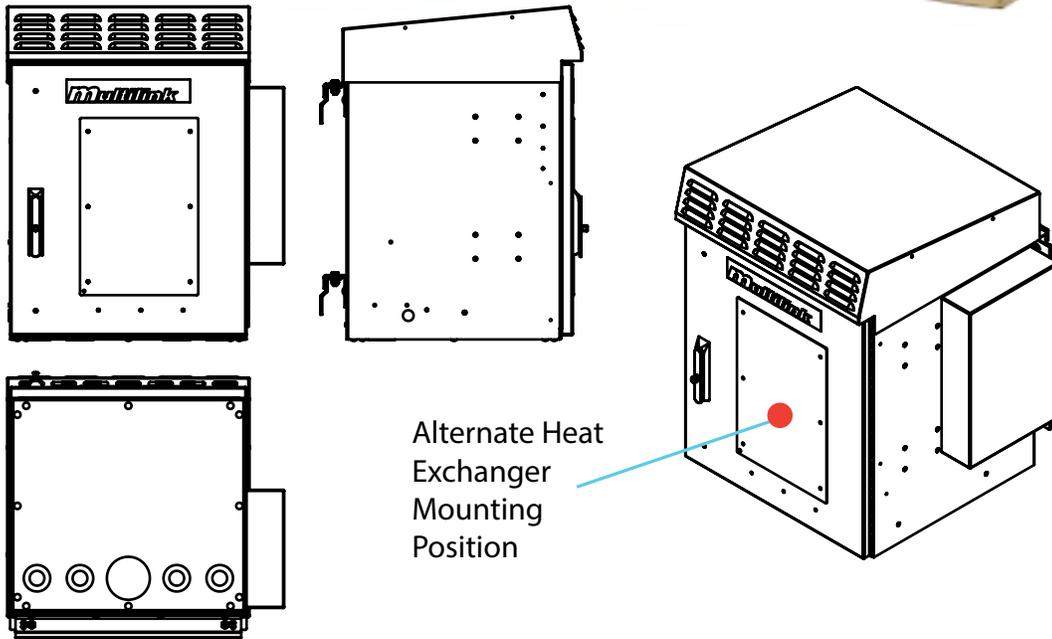

Construction

Main Body	Aluminum
Hardware	Stainless Steel
Finish	Polyester Powder Coat
Rack	19" Width 12RU Height 10-32 Threads EIA/TIA
Door	3 Point Latch, Piano Hinge, Wind Stop

Heating & Cooling	120V AC Heat Exchanger
Mounting	Wall/Unistrut
Powering	125V Duplex Receptacle
Cable Entrance	4 X(Ø1.5 X 2.25") Dual Stage Knockouts 1 X(Ø4.00") Single Stage Knockout

Stock ID	Description	Dimensions	Color	Wt. Lbs.	UOM
030-180-45	12RU Wall/Unistrut Mount w/ Heat Exchanger	31" H x 25.8" W x 24.8" D	Beige	105	Each
745-560-P1	12" Ground Mount Pedestal	12" H x 20.14" W x 22" D	Beige	-	Each



Dual Door Ground Mount 16RU

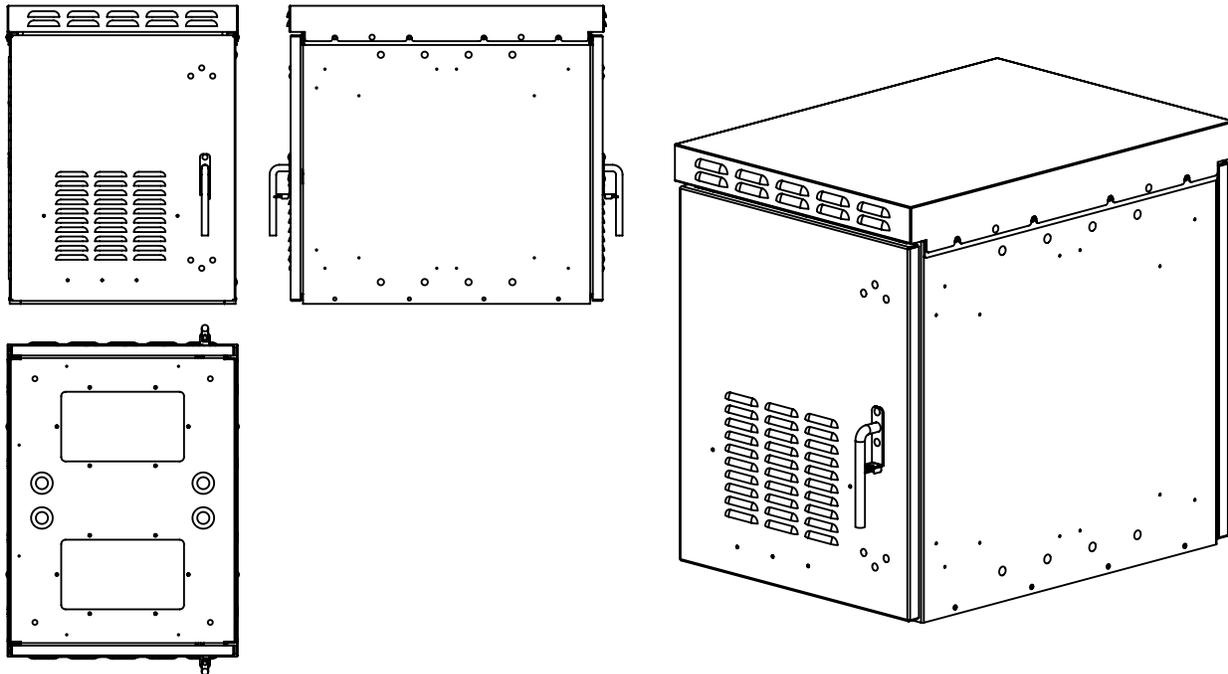

Construction

Main Body	Aluminum
Hardware	Stainless Steel
Finish	Polyester Powder Coat
Rack	19" or 23" Width 16RU Capacity Adjustable Front to Back 10-32 Threads EIA/TIA

Doors	3 Point Latch, Piano Hinge, Wind Stop, Front & Rear Doors
Heating & Cooling	Dual 120V 100CFM Fans, Vented Roof
Mounting	Ground (Concrete Pad)
Powering	Two 125V Duplex Receptacles
Cable Entrance	4 X(Ø1.38 X 2.47") Dual Stage Knockouts 2 X(14" x 8") Removable Plates

Stock ID	Description	Dimensions	Color	Wt. Lbs.	UOM
030-245-10	16RU Ground Mount Enclosure	34.25" H x 25.75" W x 40.24" D	Beige	120	Each

Specifications subject to change without notice.

© Multilink, Inc. 2013 • All Rights Reserved



Ground Mount 64RU w/ Rear Doors

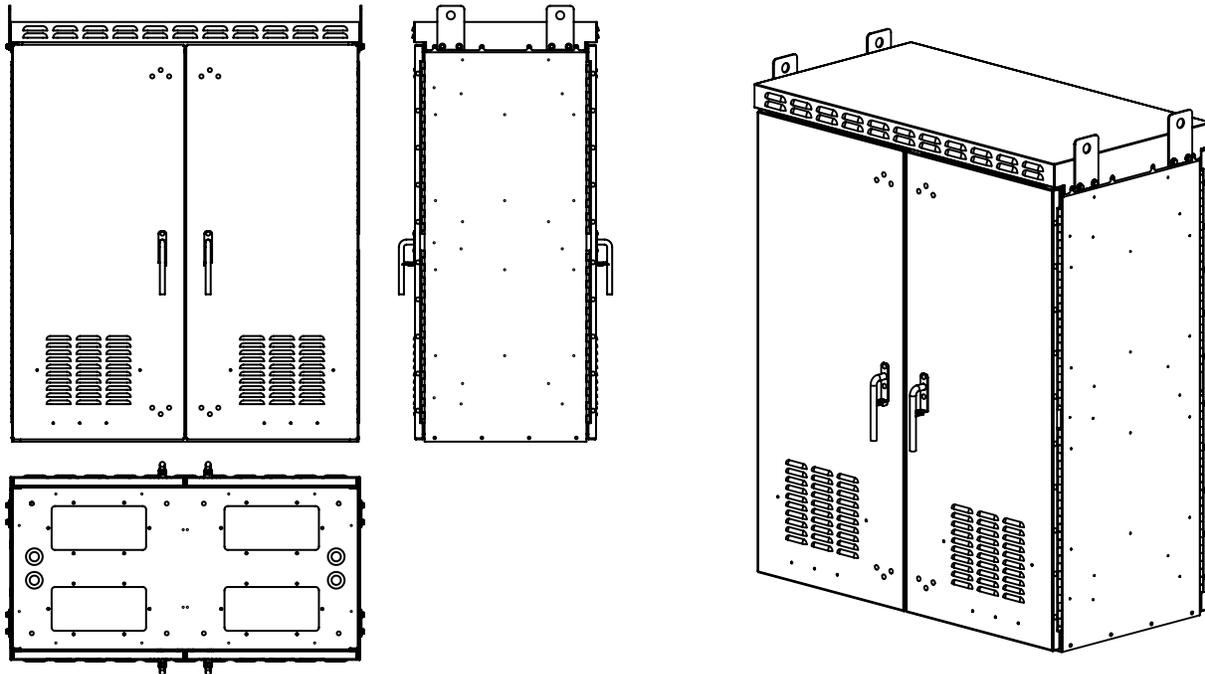

Construction

Main Body	Aluminum
Hardware	Stainless Steel
Finish	Polyester Powder Coat
Rack	19" or 23" Width 128RU Capacity (Front & Rear Rails) Adjustable Front to Back 10-32 Threads EIA/TIA

Doors	3 Point Latch, Piano Hinge, Wind Stop, Front & Rear Doors
Heating & Cooling	Dual 120V 100CFM Fans, Vented Roof
Mounting	Ground (Concrete Pad)
Powering	Two 125V Duplex Receptacles
Cable Entrance	4 X(Ø1.38 X 2.47") Dual Stage Knockouts 4 X(14" x 6.5") Removable Plates

Stock ID	Description	Dimensions	Color	Wt. Lbs.	UOM
030-247-10	64RU Ground Mount Enclosure w/ Rear Doors	62.25" H x 51.4" W x 31.6" D	Beige	-	Each

Specifications subject to change without notice.

© Multilink, Inc. 2013 • All Rights Reserved

Opto-Electronic Enclosure

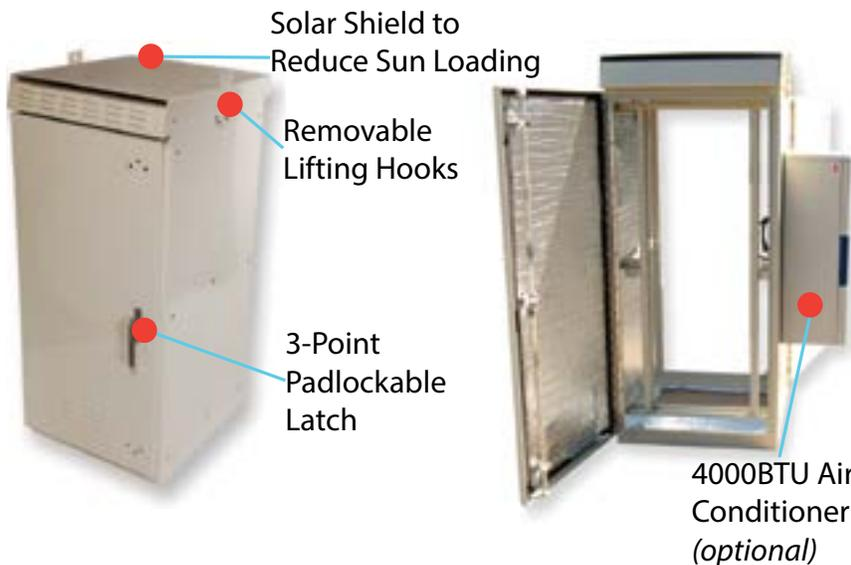

Multilink's Opto-Electronic Enclosure is designed for 19" & 23" rack mounted equipment. This enclosure is designed to protect the equipment from dust, snow and rain. It is equipped with two duplex GFI outlets, a fluorescent light that gets activated by an automatic pressure switch when the door opens. The internal rack is 52" height (29 Rack Units). Also equipped with a solar shield installed above the roof for additional protection from sun loading. An optional air conditioner is available.

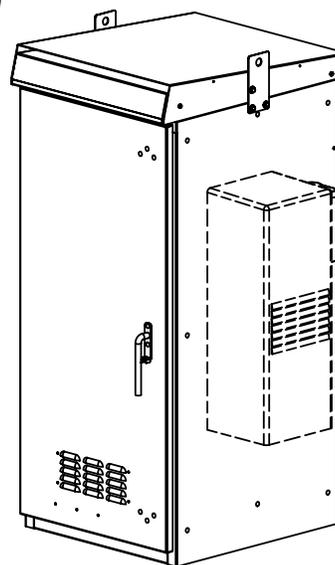
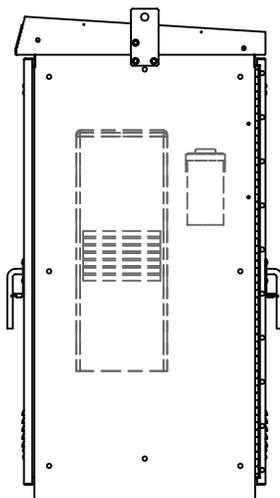
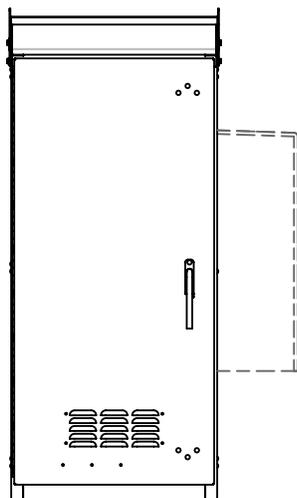

Construction

Main Body	Aluminum
Hardware	Stainless Steel
Finish	Polyester Powder Coat
Rack	19"- 23" Adjustable Width 29RU Height 10-32 Threads EIA/TIA Spacing
Door	Front and Back 3 Point Latch, Piano Hinge, Light Control Switch, Wind Stop
Cable Entrance	14" x 24" Rectangle Opening On Bottom, Rear
Mounting	Ground

Heating and Cooling	Ventilation Louvers On Bottom Of Both Doors Backed By Bug Screen Sloped Roof w/ Ventilation Louvers Backed By Bug Screen Solar Shield Protecting Roof Fan Shelf, 1RU, (6) 100 CFM Fans Mounted On Rack at Top (744-386-20) 120Vac, 15A Breaker, 10ft Cord
Optional Air Conditioner	4000 BTU Air Conditioning w/ Integral Heater
Powering	Customer To Supply 120/240VAC (3) Duplex Receptacle GFCI, 15A, 125VAC, 60Hz (1) Light, 18", 15W, 120VAC (F15-T8-CW/TSC) Controlled By Door Switch

Stock ID	Description	Dimensions	Color	Wt. Lbs.	UOM
030-129-10	Opto-Electronic Enclosure	65.5" H x 28" W x 33" D	Beige	230	Each
030-129-20	Opto-Electronic Enclosure w/ A/C Unit & Service Entrance	65.5" H x 28" W x 33" D	Beige	270	Each

Dual Door Backhaul 17RU

Product Updated

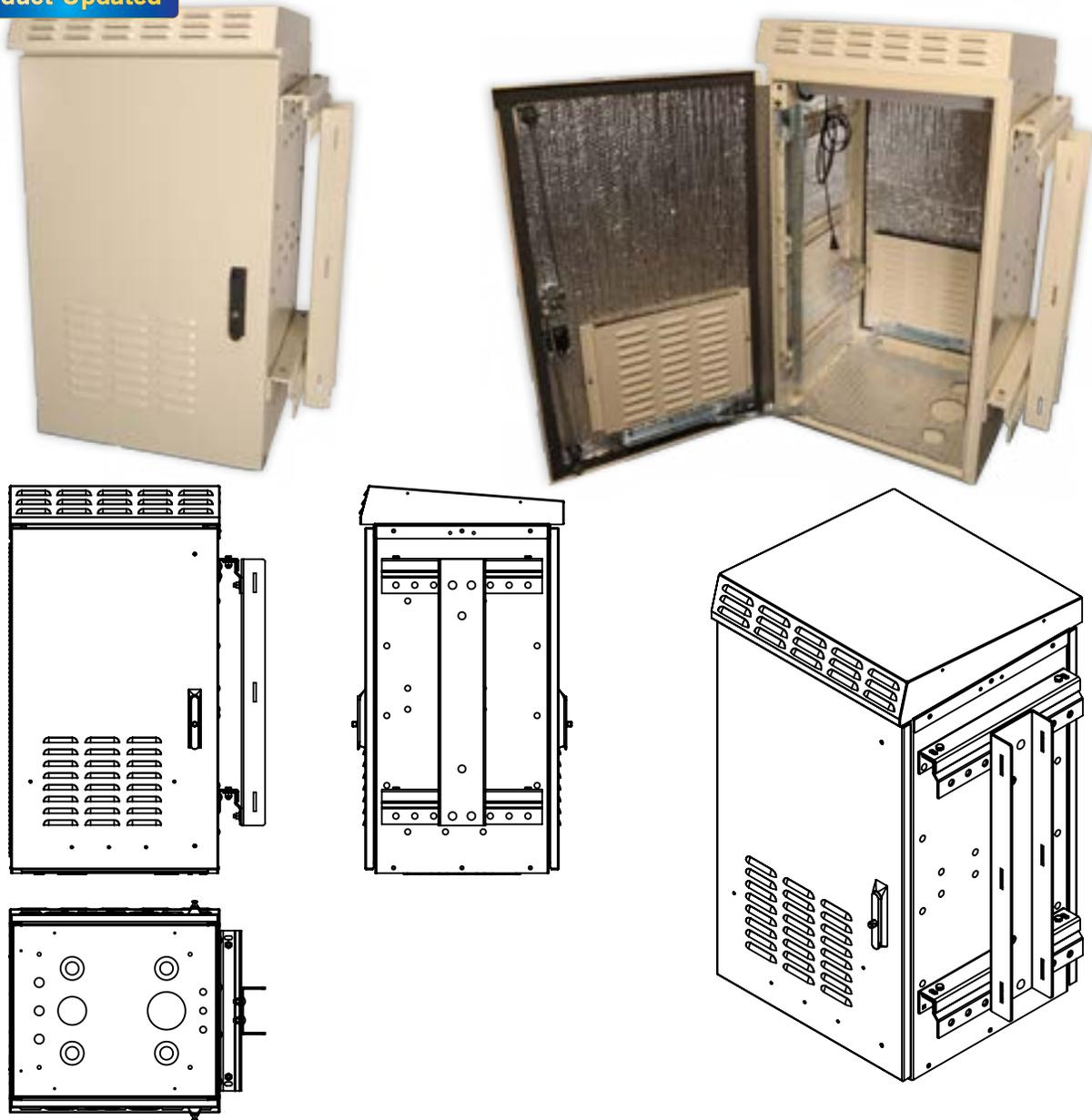

Construction

Main Body	Aluminum
Hardware	Stainless Steel
Finish	Beige Polyester Powder Coat
Rack	19" Width 17RU Height 10-32 Threads EIA/TIA Spacing
Door	Front and Back 3 Point Latch, Piano Hinge, Light Control Switch, Wind Stop

Heating & Cooling	Full Foil-Faced Insulation, Strategically Placed Ventilation Louvers, Patented Lifesaver Design, and (2) 100CFM Fans
Mounting	Pole Mount
Powering	Dual 125V Duplex Receptacles
Cable Entrance	2 X(Ø2.47 X1.38") Dual Stage Knockouts 1 X(Ø4.00") Single Stage Knockout

Stock ID	Description	Dimensions	Color	Wt. Lbs.	UOM
030-201-10	17RU Dual Door Backhaul	41.1" H x 26.9" W x 23.3" D	Beige	150	Each
745-281-P2	Ground Mount Pedestal	6" H x 22" W x 18.4" D	Beige	10	Each

Backhaul 18 RU w/Generator Hookup

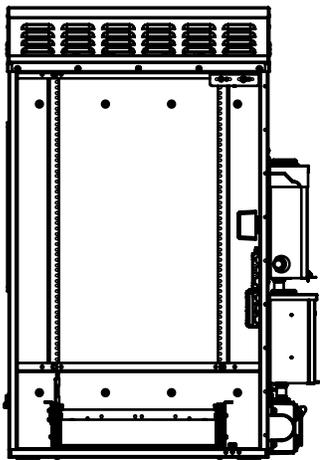

Front View With Door Removed

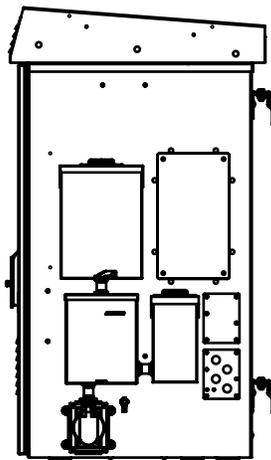

Rear View With Pole Bracket Removed

Construction

Main Body	Aluminum
Hardware	Stainless Steel
Finish	Polyester Powder Coat
Rack	19" Width 18RU Height 10-32 Threads EIA/TIA
Door	3 Point Latch, Piano Hinge, Wind Stop

Heating & Cooling	Dual thermostatically controlled, 48V DC, 100CFM fans with patented lifesaver roof and heat shield
Mounting	Wall
Powering	Dual 125V Quad Receptacles, 100Amp 120/240V 6 Position Service Entrance, 70Amp 240V 2 Position Service Entrance, and Generator Hookup w/Transfer Switch
Cable Entrance	6 X(Ø1" X 2") Dual Stage Knockouts

Stock ID	Description	Dimensions	Color	Wt. Lbs.	UOM
030-185-10	WMO-18RU-N4-BAT-BE	50" H x 34.5" W x 28.5" D	Beige	260	Each

Wall/Pole Mount 14-RU-N4-AC

An above ground housing to shelter environmentally sensitive equipment from rain, sleet, snow, dust, driving wind, hail, corrosion, and vandalism.

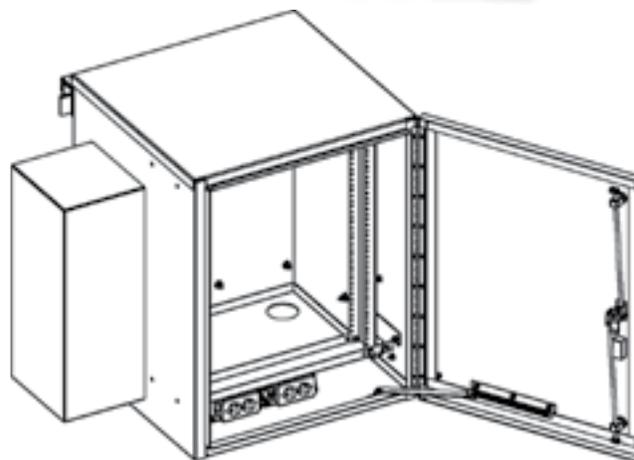
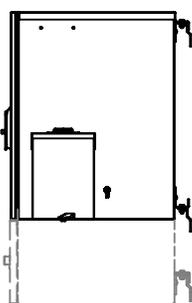
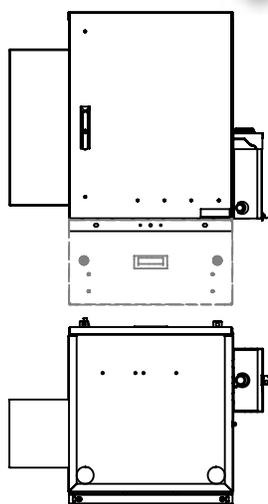

Construction

Main Body	1/8" Aluminum
Hardware	Type 304 Stainless Steel
Finish	Polyester Powder Coat
Rack	19" Width 14RU Height 10-32 Threads EIA/TIA Spacing
Door	3 Point Latch, Piano Hinge Wind Stop
Optional Battery Drawer Capacity	(3) Group 31 or (3) Group 24 or (3) Group 27

Cable Entrance	Standard - (2) 3" conduit entrances located in the bottom rear of the compartment With Battery Drawer - (2) 2.5" conduit entrances located in the back wall
Heating and Cooling	1400-1600 BTU Air Conditioner
Grounding	All components are grounded to the main copper bus bar
Powering	60 Amp Service Entrance AC Load Center (2) Duplex Outlets, 125V 20 Amp Breaker

Stock ID	Description	Dimensions	Color	Wt. Lbs.	UOM
030-152-10	PMO-14RU-N4-AC Pole Mount Enclosure	30.5" H X 24" W x 24" D	Gray	185	Each
030-152-20	WMO-14RU-N4-AC Wall Mount Enclosure w/ 500watt Integral Heater	30.5" H X 24" W x 24" D	Gray	185	Each
030-146-10	WMO-14RU-N4-AC-BAT-PG Wall Mount Enclosure w/ Battery Drawer	43" H x 28" W x 23" D	Gray	205	Each
030-146-11	WMO-14RU-N4-AC-BAT-BE Wall Mount Enclosure w/ Battery Drawer	43" H x 28" W x 23" D	Beige	205	Each
030-151-10	PMO-14RU-N4-AC-BAT-PG Pole Mount Enclosure w/ Battery Drawer	43" H x 28" W x 23" D	Gray	205	Each
030-151-11	PMO-14RU-N4-AC-BAT-BE Pole Mount Enclosure w/ Battery Drawer	43" H x 28" W x 23" D	Beige	205	Each

17RU Mini-OTN

An above ground housing to shelter environmentally sensitive equipment from rain, sleet, snow, dust, driving wind, hail, corrosion, and vandalism.

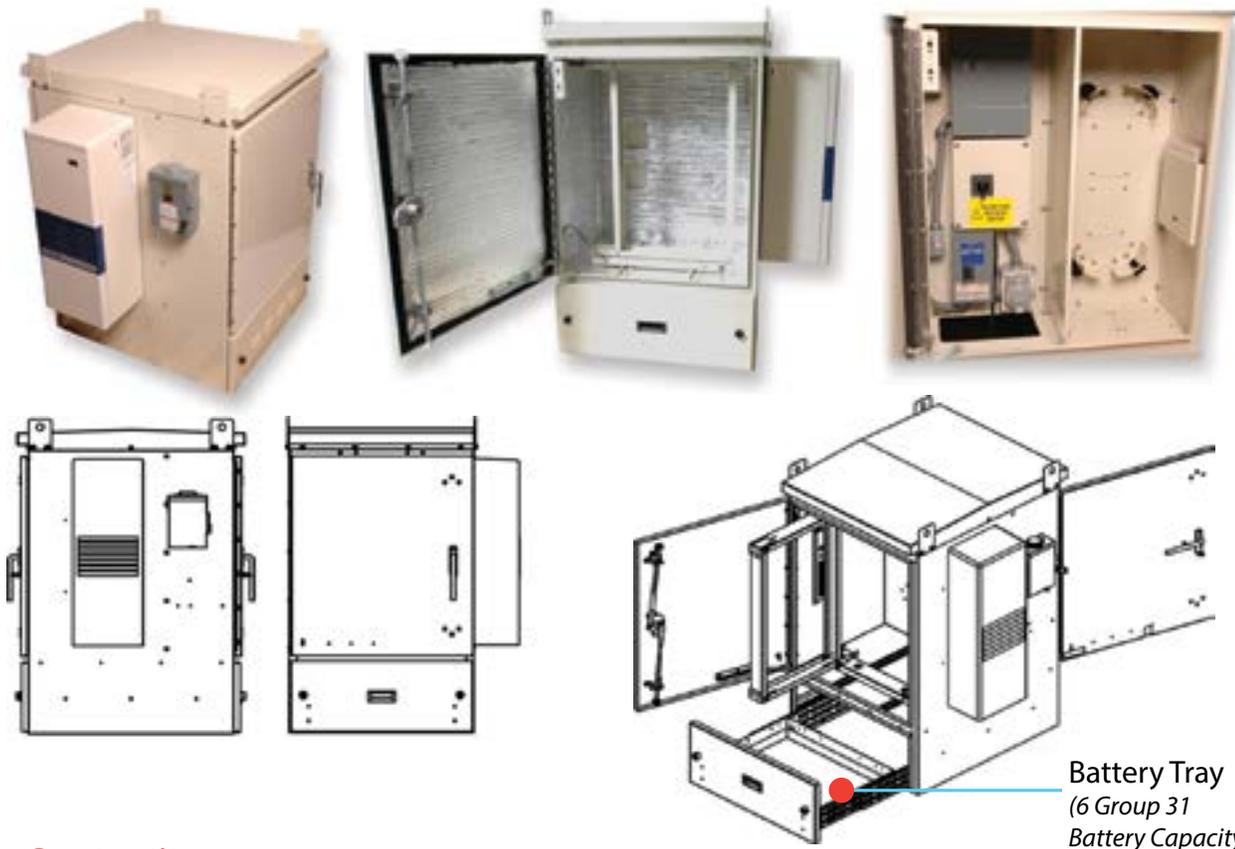

Battery Tray
(6 Group 31
Battery Capacity)

Construction

Main Body	1/8" Aluminum
Hardware	Type 304 Stainless Steel
Finish	Polyester Powder Coat
Rack	19"-23" Adjustable Width 17 RU Height 10-32 threads EIA/TIA spacing
Door	Front - (Rack Section) 3 Point Latch, Piano Hinge, Light Control Switch, Wind Stop Back - (Power Slack Storage Section) 3 Point Latch, Piano Hinge, Wind Stop
Cable Entrance	8" x 20" Regular Opening On Bottom Back
Heating & Cooling	4000 BTU Air Conditioning w/ Integrated Heater

Grounding	All components are grounded to the main copper bus bar
Powering	120/240VAC Service Entrance, 30A/250VAC Fuses Generator Hook-Up w/ Manual Switch (1) Duplex Receptacle, GFCI 20A, 125VAC, 60Hz (1) Duplex Receptacle, GFCI 15A, 125VAC, 60Hz (1) Power Strip, 6 Positions, 120VAC, 15A Breaker (1) Light, 18", 15W, 120V (F15 T8 CW/TSC) Controlled By Front Door Switch

Stock ID	Description	Dimensions	Color	UOM
030-123-10	Mini OTN w/ 4000 BTU A/C Unit	55.25" H x 42.5" W x 39" D	Beige	Each
030-123-50	Mini OTN w/o A/C Unit	55.25" H x 39" W x 39" D	Beige	Each
030-120-10	Mini OTN, w/ 6000 BTU A/C Unit	55.25" H x 42.5" W x 39" D	Beige	Each

OTN Cabinets

The Multilink OTN Cabinet was designed to solve all your remote access needs. It has a compartmentalized design which is easily configurable to fit most applications in the CATV, Outside Plant, and Wireless markets. It can serve as a mini-headend, optical transition node, repeater, hub site, telephony "point of presence", or a cellular microcell site. It is 100% environmentally sealed, therefore, it can house and protect all your environmentally sensitive equipment from the rain, snow, sleet, hail, and driving winds.



6 Bay OTN



2 Bay OTN



4 Bay OTN

Construction

Main Body	1/8" Aluminum
Hardware	Type 304 Stainless Steel
Finish	Polyester Powder Coat
Rack	19"-23" Adjustable Width 10-32 Threads EIA/TIA Spacing 2 Bay 47RU / 4 Bay 95RU / 6Bay 142 RU *Front Racks Swing, Back Fixed
Door	3 Point Latch, Light Control Switch, Piano Hinge, Wind Stop

Cable Entrance	Large Openings On Bottom Of Power And Slack Storage Ends
Heating and Cooling	8,000-12,000 BTU Air Conditioning w/ Integrated Heater Heat Exchangers Available As Options
Grounding	All components are grounded to the main copper bus bar
Mounting	Ground
Powering	60 Amp generator hook-up MAC load center w/ GFI outlets 220V outlet

Stock ID	Description	Dimensions	Rack Units	Color	Wt. Lbs.	UOM
14002-1	2 Bay OTN Cabinet Without Battery Tray - 8,000 BTU A/C	62.5" H x 54.5" W x 36.5" D	47	Gray	760	Each
14002-2	2 Bay OTN Cabinet With Battery Tray - 8,000 BTU A/C	62.5" H x 54.5" W x 36.5" D	47	Gray	760	Each
14002-2BE	2 Bay OTN Cabinet With Battery Tray - 8,000 BTU A/C	62.5" H x 54.5" W x 36.5" D	47	Beige	760	Each
14001	4 Bay OTN Cabinet With Battery Tray - 12,000 BTU A/C	62.5" H x 78.5" W x 36.5" D	95	Gray	960	Each
030-155-20	4 Bay OTN Cabinet With Battery Tray 13,000 BTU A/C and Solar Shield	62.5" H x 78.5" W x 36.5" D	95	Gray	960	Each
030-179-10	4 Bay OTN Cabinet With Battery Tray - 48Vdc 2,500 Watt Heat Exchanger and 4 Swingout Racks	62.5" H x 78.5" W x 36.5" D	95	Beige	960	Each
14000	6 Bay OTN Cabinet With Battery Tray - 12,000 BTU A/C	62.5" H x 106.5" W x 36.5" D	142	Gray	1,200	Each

OTN Cabinet

Power Section Equipped with Heat Exchanger: Multilink OTN Cabinets are available with air conditioning or heat exchanger, depending upon the climate that the cabinet is being used in, and the thermal rating of the electronics housed within. Call Multilink Customer Service, and we can help you choose the best cabinet for your application!

**OTN Cabinets can be ordered as a complete assembly including fiber management & patch panels. Please call Customer Service for more information and ordering options.



Cabinet Options



Product Description

Multilink’s Fan Shelf is designed for both 19” & 23” rack configurations. It provides a massive airflow of 600 CFM. This unique design enables an automatic activation and deactivation of the fans at 100° F and at 90° F respectively. The Fan Shelf operates on 120V AC and is also equipped with a 15 Amp circuit breaker switch (conveniently located towards the front) and a 10 ft. power cord for convenient use in any sized enclosure. Included with the Fan Shelf is a universal mounting kit with required hardware to enable 19” or a 23” configuration.

General Specifications

Construction	Durable Aluminum Construction
Material	3003 H-14 Aluminum
Hardware	Stainless Steel

Finish	Powder Coat Black
Dimensions	17”W x 1.75”H x 14.84” D
Weight	14 lbs. (6.35kg)

Part #	Description	Dimensions	Weight (lbs)	UOM
744-386-20	600 CFM Fan Shelf	28” W x 1.75” H x 14.84” D	14	Each

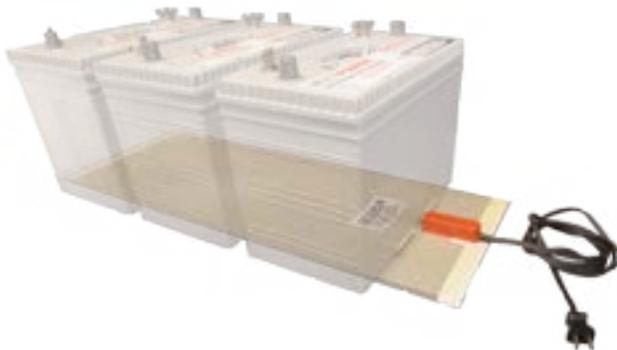

Battery Heater Pad

Stock ID	035-079-10
Description	3 Battery Configuration Heater Pad with 6’ Power Cord 120V/175W
UOM	Each
Dimensions	10”W x 27”L

Additional Sizes Available Upon Request

Custom Cabinet Ordering Guide

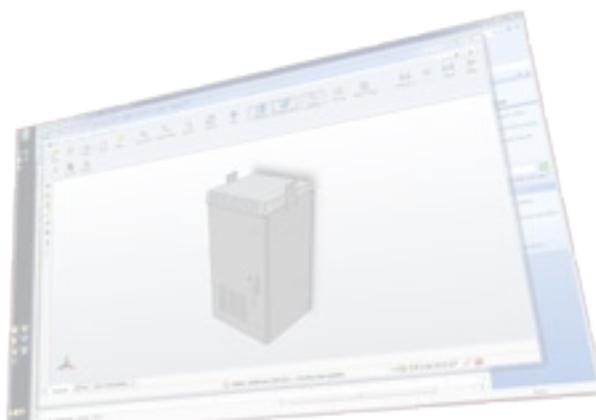
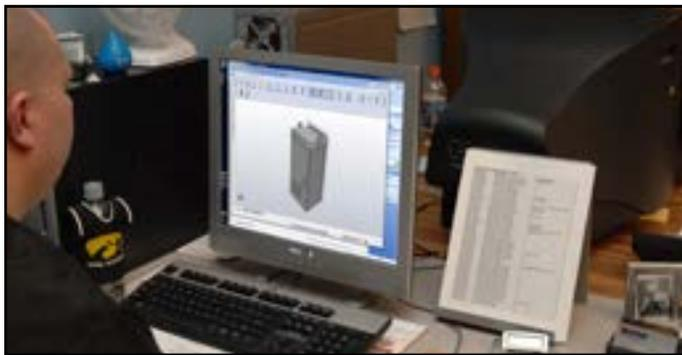

Features	Options	Response
Cabinet Environment	Indoor or Outdoor	
Material	Steel or Aluminum	
Preferred Size	H" x W" x D"	
Color	Beige, Gray, White (Contact for custom color)	
Access Doors	Front, Rear, or Dual	
Desired Locking Mechanism	Cam Lock, 3-Point Latch, Pad Lockable, etc...	
Heating & Cooling	Vents, Fans, A/C, Heat Exchanger (Please contact us to discuss the application)	
Insulating Foil	Yes or No	
Solar Shield	Yes or No	
Electrical Outlet	Yes or No (If yes please specify quantity, Amps & voltage details)	
Service Entrance	Yes or No (If yes please specify number of breakers, Amps & voltage details)	
Meter Base	Yes or No (If yes please specify Amps and any other details)	
Mounting Preference	Wall Mount, Pole Mount, Unistrut Mount, or Pad Mount	
Fiber Management Tie Down Strips	Yes or No	
Generator Disconnect	Yes or No	
Surge Suppression	Yes or No	
Rack System	Yes or No (If yes please specify width)	
Rack Spaces Required	If applicable	
Rack Style	Swing out or Fixed	
Front To Back Adjustable Rack	Yes or No	
Pre-Threaded Rack	Yes or No (If yes please specify screw size)	
Max Equipment Depth	If applicable	
Desired Clearance	From front face of rack rails to the inside face of the door	
Separate Battery Storage	Yes or No	
Light Kit	Yes or No	

Transportation Technology Products



95% of all Multilink products are manufactured in the USA. What that means to you is faster delivery, better quality products, and the satisfaction of knowing you are keeping American workers employed.

336 Stretch Traffic Control Cabinet

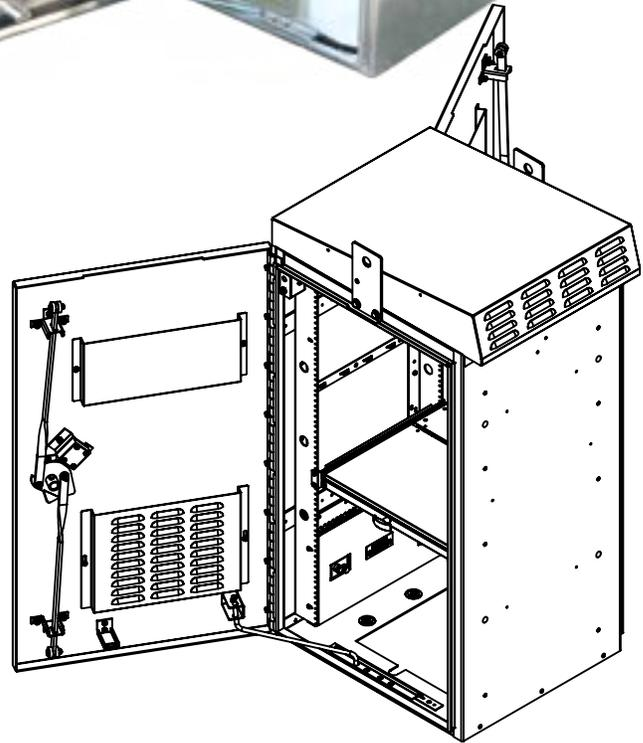
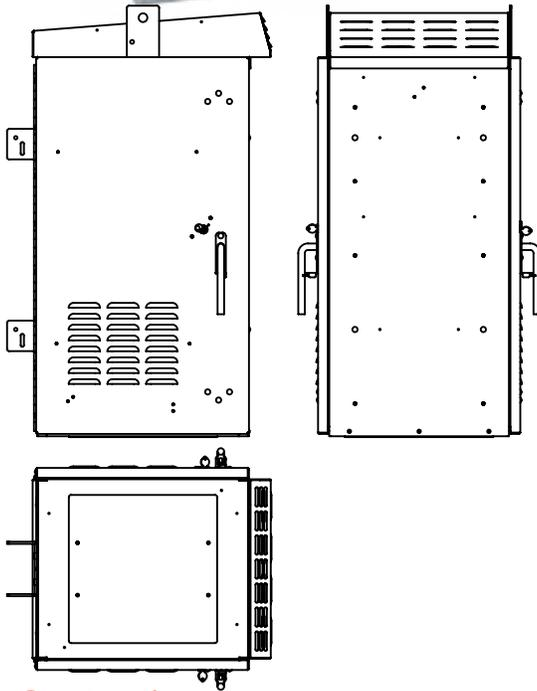

Construction

Main Body	1/8" Aluminum w/Synthetic Rubber Seal
Hardware	Stainless Steel
Finish	Bare
Rack	19" Width 21RU Free Spaces (23RU Total Capacity) 10-32 Treads EIA/TIA Spacing
Door	Dual Door, 3 Point Latch, Corbin #2 Lock, Piano Hinge, Wind Stop, Vent Pocket, Document Holder

Cable Entrance	Cable entry locations in bottom of enclosure
Heating and Cooling	Forced convection w/ cooling fans
Grounding	All components are grounded to the main ground bar
Powering	120V AC ,60Hz 1-PHASE
Accessories/ Special Features	CCTV Panel, 1RU Sliding Drawer Shelf, Power Strip, 2 Light Fixtures

Stock ID	Description	Dimensions	Color	Wt. Lbs.	UOM
030-183-11	336 Stretch Traffic Cabinet	48.6"H x 24.4"W x 23.25"D	Bare	205	Each

Specifications subject to change without notice.

© Multilink, Inc. 2013 • All Rights Reserved

336 Stretch Traffic Control Cabinet

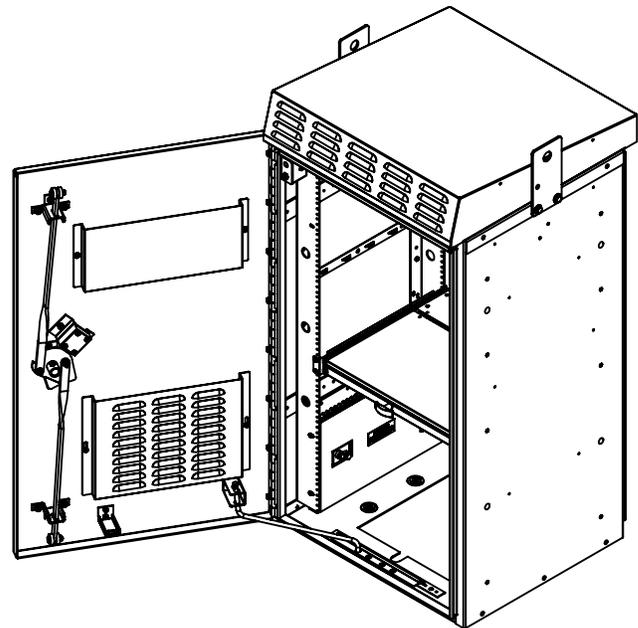
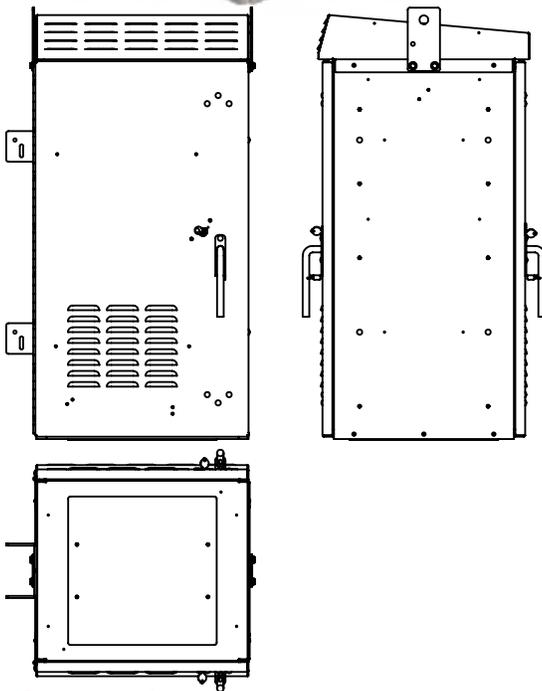

Construction

Main Body	1/8" Aluminum w/Synthetic Rubber Seal
Hardware	Stainless Steel
Finish	Bare
Rack	19" Width 21RU Free Spaces (23RU Total Capacity) 10-32 Treads EIA/TIA Spacing
Door	Dual Door, 3 Point Latch, Corbin #2 Lock, Piano Hinge, Wind Stop, Vent Pocket, Document Holder

Cable Entrance	Cable entry locations in bottom of enclosure
Heating and Cooling	Forced convection w/ cooling fans
Grounding	All components are grounded to the main ground bar
Powering	120V AC .60Hz 1-PHASE
Accessories/ Special Features	CCTV Panel, 1RU Sliding Drawer Shelf, Power Strip, 2 Light Fixtures

Stock ID	Description	Dimensions	Color	Wt. Lbs.	UOM
030-206-10	336 Stretch Traffic Cabinet	48.7"H x 24.4"W x 23.2"D	Bare	-	Each



336 Traffic Control Cabinet

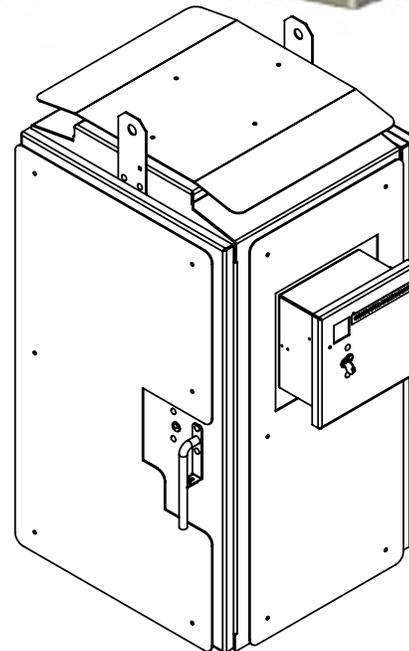
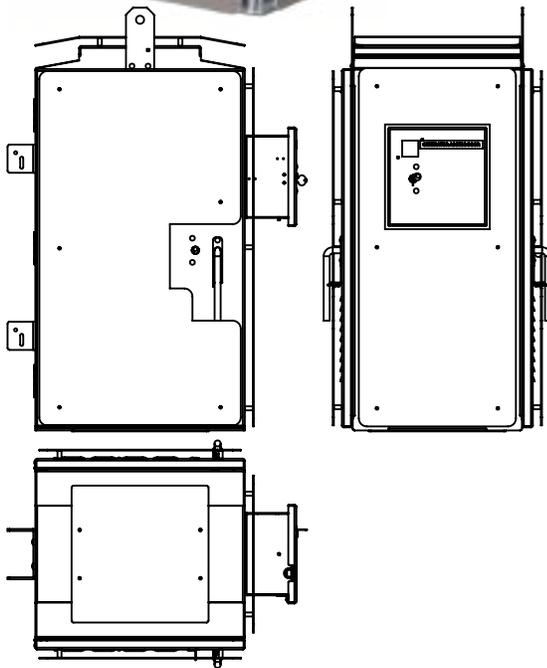

Construction

Main Body	1/8" Aluminum w/Synthetic Rubber Seal
Hardware	Stainless Steel - 316 or 304
Finish	Bare
Rack	19" Width 21RU Total Capacity 10-32 Treads EIA/TIA Spacing
Door	Dual Door, 3 Point Latch, Corbin #2 Lock, Piano Hinge, Wind Stop, Vent Pocket, Document Holder Hooks
Mounting	Pole or Ground Mount

Cable Entrance	Cable entry locations in bottom of enclosure
Heating and Cooling	Forced convection w/ cooling fans and heat sheilds
Grounding	All components are grounded to the main ground bar
Powering	120V AC .60Hz 1-PHASE
Accessories/ Special Features	1RU Sliding Drawer Shelf, 2 (16w) Light Fixtures Each Side Independent Transfer Switch Enclosure Welded on Side w/ Corbin Lock, Gasketing, and Green LED Indicator Light

Stock ID	Description	Dimensions	Color	Wt. Lbs.	UOM
030-238-50	336 Traffic Cabinet	52.6"H x 35.8"W x 28.2"D	Bare	225	Each

Specifications subject to change without notice.

© Multilink, Inc. 2013 • All Rights Reserved

332 Traffic Control Cabinet

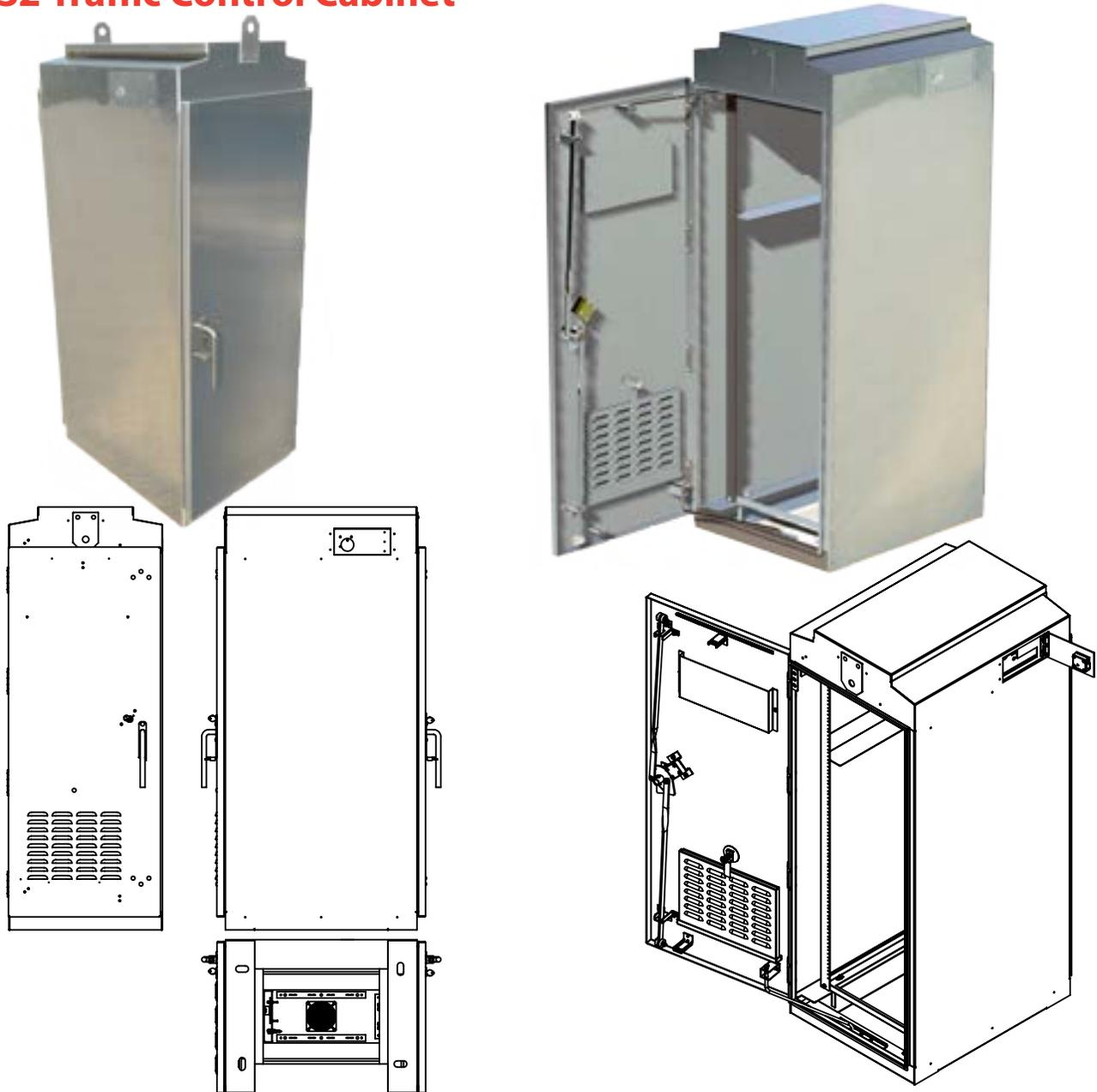

Construction

Main Body	1/8" Aluminum w/Synthetic Rubber Seal
Hardware	Stainless Steel
Finish	Bare
Rack	19" Width 30RU Free Spaces 10-32 Treads EIA/TIA Spacing
Door	Dual Door, 3 Point Latch, Corbin #2 Lock, Piano Hinge, Wind Stop, Vent Pocket, Document Holder

Cable Entrance	Cable entry locations in bottom of enclosure
Heating and Cooling	Forced convection w/ thermostatically controlled cooling fans
Grounding	N/A
Powering	N/A
Accessories/ Special Features	Removable Rack Assembly

Stock ID	Description	Dimensions	Color	Wt. Lbs.	UOM
030-222-10	332 Traffic Cabinet (as shown)	66.8"H x 24.25"W x 33"D	Anodized	-	Each
030-222-20	332 Traffic Cabinet	66.8"H x 24.25"W x 33"D	Bare	-	Each

Specifications subject to change without notice.

© Multilink, Inc. 2013 • All Rights Reserved

Flasher Style Traffic Cabinet

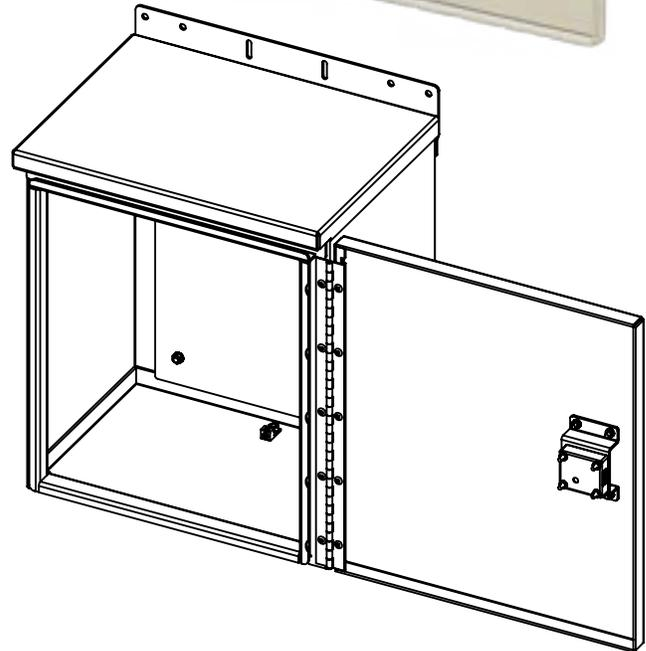
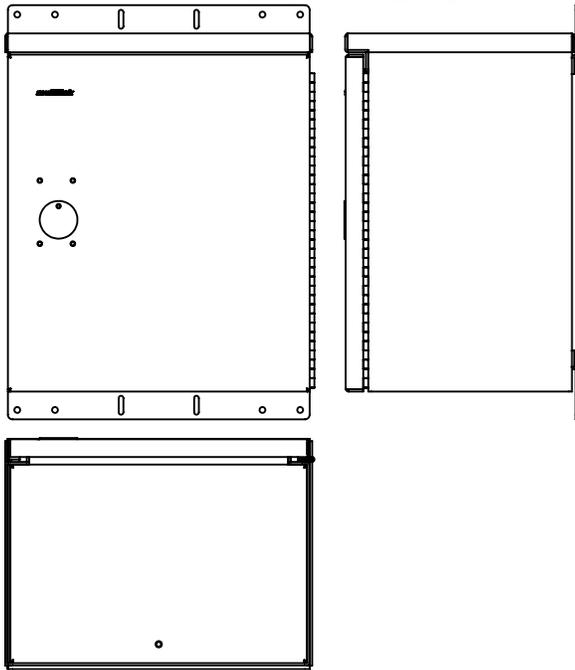
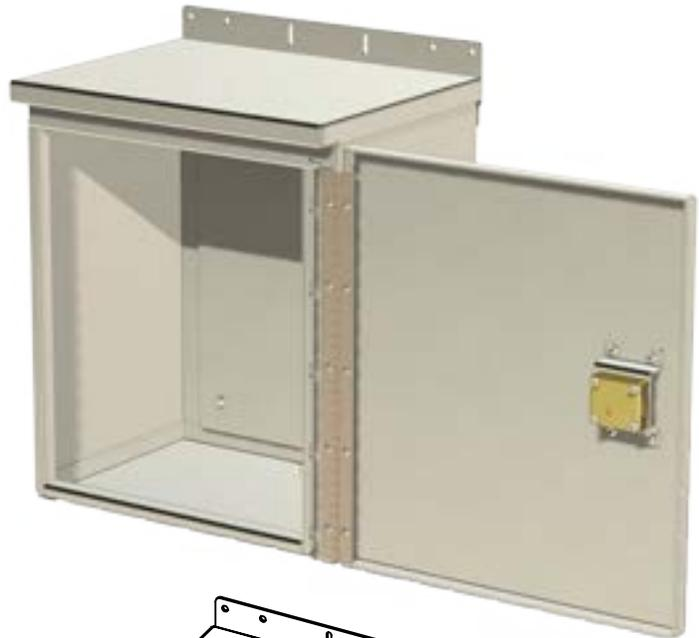

Construction

Main Body	1/8" Aluminum w/Synthetic Rubber Seal
Hardware	Stainless Steel
Finish	Bare
Rack	N/A
Door	Single Door, Corbin Lock w/Skeleton Key, Piano Hinge

Cable Entrance	Knockouts for 2" conduit in bottom of enclosure
Heating and Cooling	N/A
Grounding	Ground lug
Powering	N/A
Accessories/ Special Features	Raised back plate

Stock ID	Description	Dimensions	Color	Wt. Lbs.	UOM
050-141-10	RN1H-161912 Traffic Cabinet	19"H x 16"W x 12"D	Bare	-	Each

Specifications subject to change without notice.

© Multilink, Inc. 2013 • All Rights Reserved

Flasher Style Traffic Cabinet

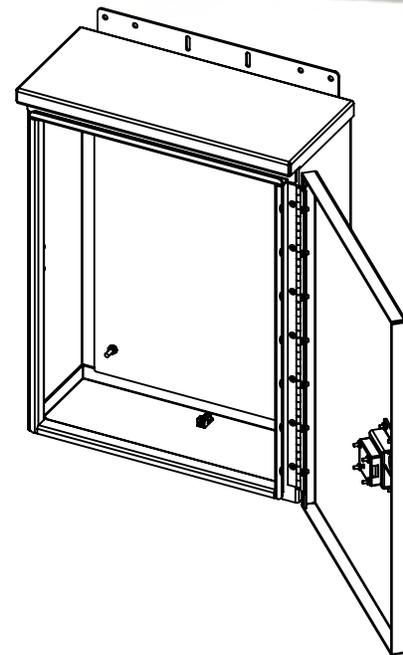
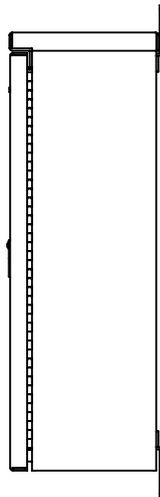
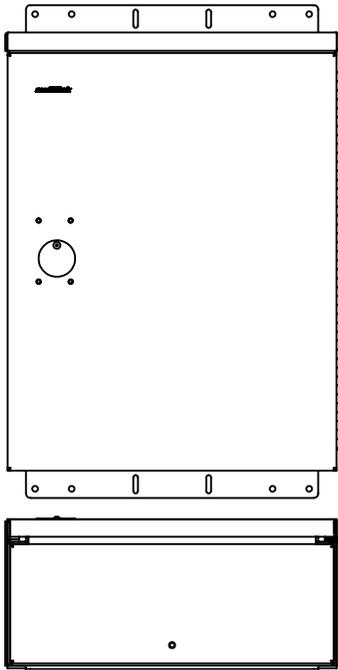

Construction

Main Body	1/8" Aluminum w/Synthetic Rubber Seal
Hardware	Stainless Steel
Finish	Bare
Rack	N/A
Door	Single Door, Corbin Lock w/Skeleton Key, Piano Hinge

Cable Entrance	Knockouts for 2" conduit in bottom of enclosure
Heating and Cooling	N/A
Grounding	Ground lug
Powering	N/A
Accessories/ Special Features	Raised back plate

Stock ID	Description	Dimensions	Color	Wt. Lbs.	UOM
050-140-10	RN1H-18248 Traffic Cabinet	24"H x 18"W x 8"D	Bare	-	Each

Specifications subject to change without notice.

© Multilink, Inc. 2013 • All Rights Reserved

Flasher Style Traffic Cabinet

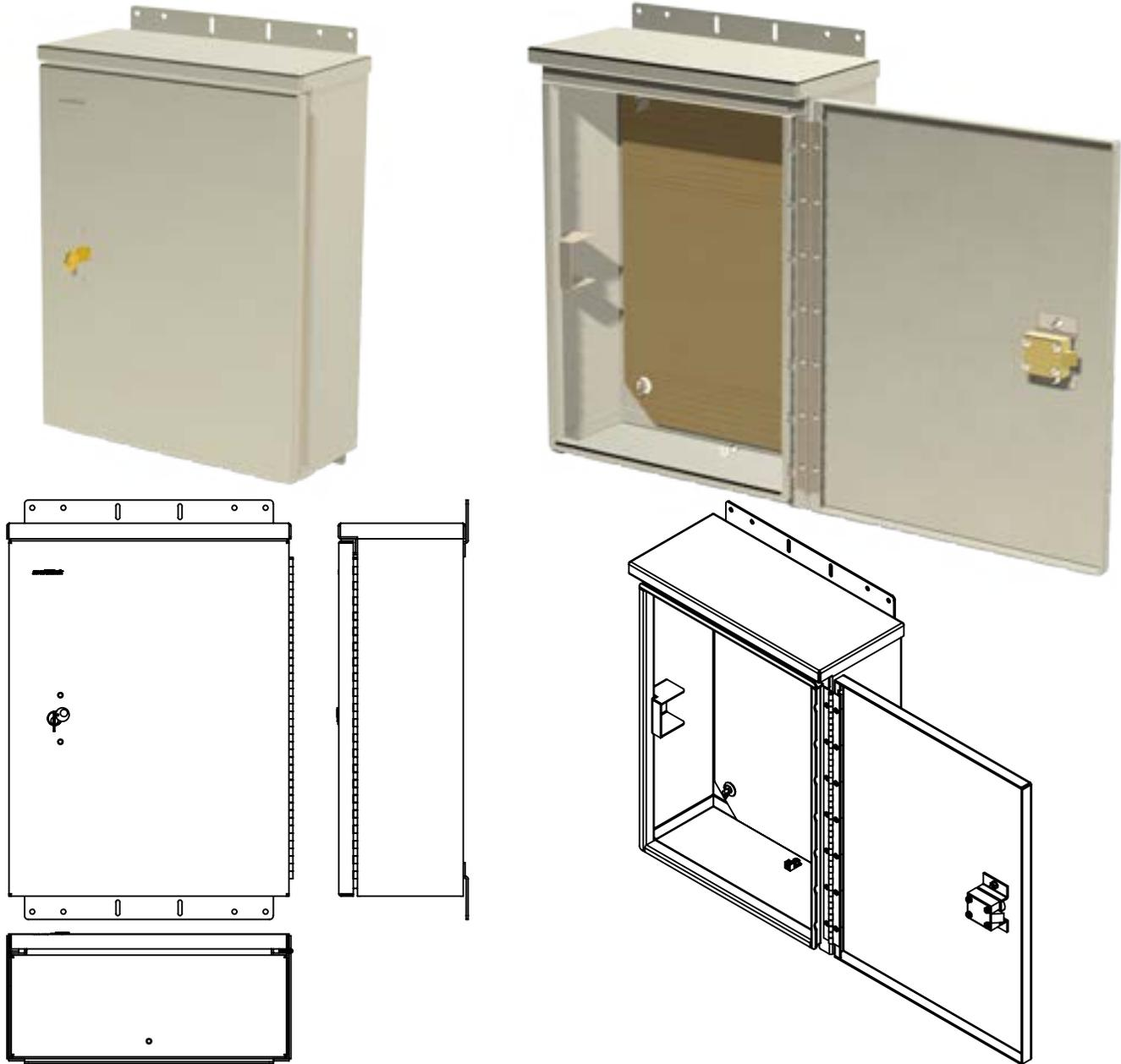

Construction

Main Body	1/8" Aluminum w/Synthetic Rubber Seal
Hardware	Stainless Steel
Finish	Bare
Rack	N/A
Door	Single Door, Right Hand Corbin #2 Lock, Piano Hinge

Cable Entrance	Knockouts for 2" conduit in bottom of enclosure
Heating and Cooling	N/A
Grounding	Ground lug
Powering	N/A
Accessories/ Special Features	Raised back plate

Stock ID	Description	Dimensions	Color	Wt. Lbs.	UOM
050-147-10	RN1H-18248 Traffic Cabinet	24"H x 18"W x 8"D	Bare	-	Each

Specifications subject to change without notice.

© Multilink, Inc. 2013 • All Rights Reserved

Flasher Style Traffic Cabinet

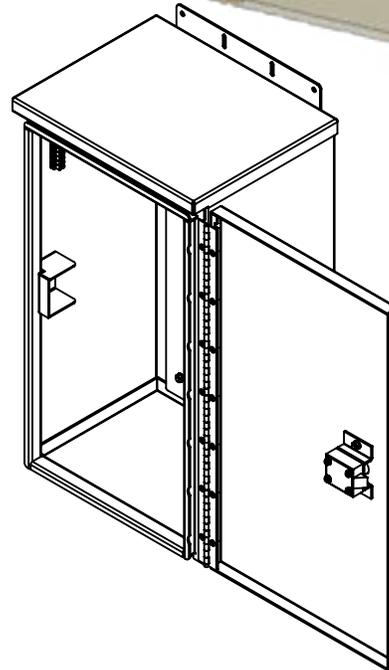
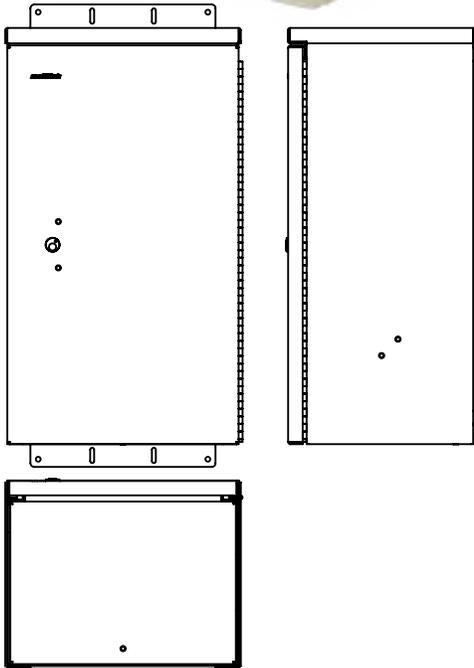

Construction

Main Body	1/8" Aluminum w/Synthetic Rubber Seal
Hardware	Stainless Steel
Finish	Bare
Rack	N/A
Door	Single Door, Right Hand Corbin #2 Lock, Piano Hinge

Cable Entrance	Knockouts for 2" conduit in bottom of enclosure
Heating and Cooling	N/A
Grounding	Ground lug
Powering	N/A
Accessories/ Special Features	Raised back plate

Stock ID	Description	Dimensions	Color	Wt. Lbs.	UOM
050-150-10	Type II Flasher Traffic Cabinet	27"H x 15.25"W x 12"D	Bare	-	Each

Specifications subject to change without notice.

© Multilink, Inc. 2013 • All Rights Reserved

Flasher Style Traffic Cabinet

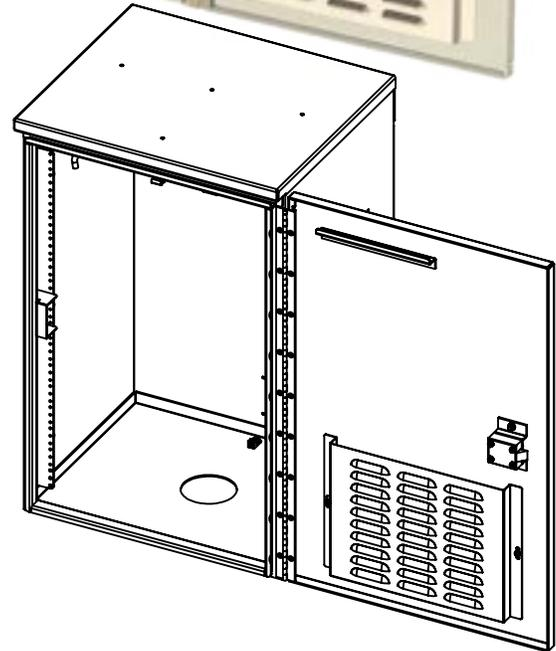
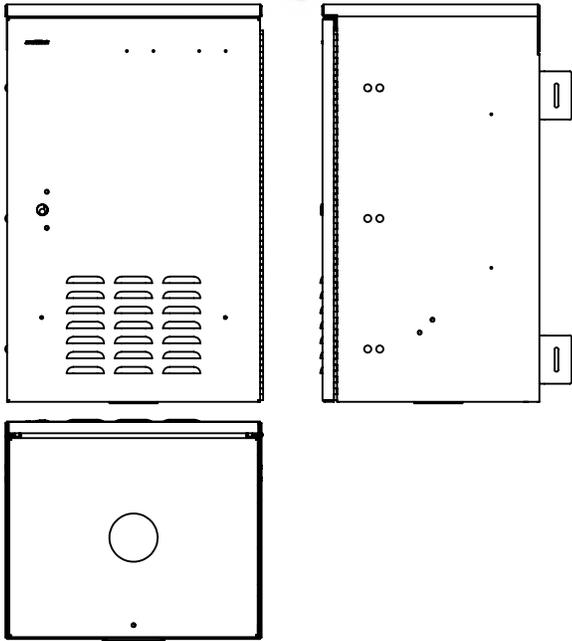

Construction

Main Body	1/8" Aluminum w/Synthetic Rubber Seal
Hardware	Stainless Steel
Finish	Bare
Rack	19" Width 16RU Height 12-24 Treads EIA/TIA Spacing
Door	Single Door, Right Hand Corbin #2 Lock, Piano Hinge, Wind Stop, Vent Pocket

Cable Entrance	Knockout for 3" conduit on bottom
Heating and Cooling	Forced convection w/ thermostatically controlled cooling fans
Grounding	Ground lug
Powering	N/A
Accessories/ Special Features	Duplex Outlet

Stock ID	Description	Dimensions	Color	Wt. Lbs.	UOM
050-199-30	RN1H-213318 Traffic Cabinet	33"H x 21.25"W x 18"D	Bare	-	Each

Type 30IV Traffic Cabinet

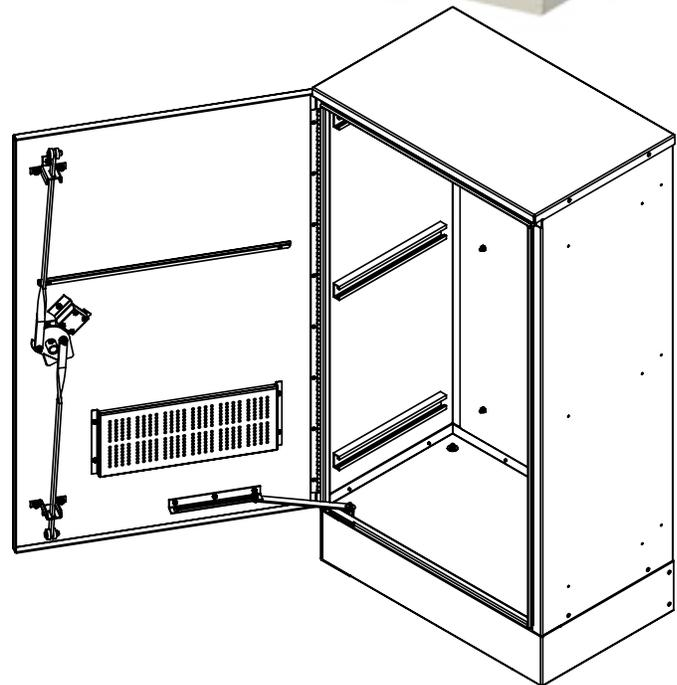
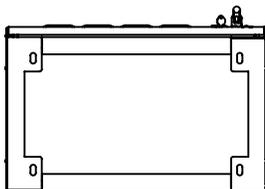
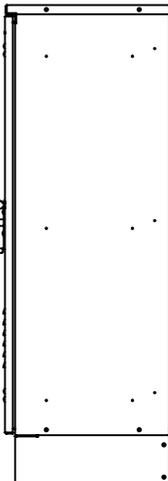
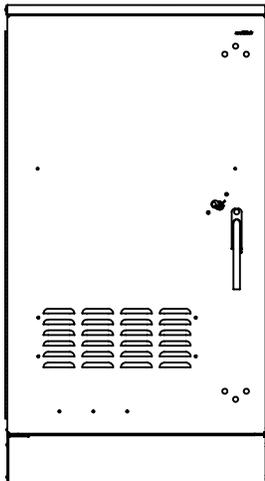

Construction

Main Body	1/8" Aluminum w/Synthetic Rubber Seal
Hardware	Stainless Steel
Finish	Bare
Rack	N/A
Door	Single Door, 3 Point Latch, Corbin #2 Lock, Piano Hinge, Wind Stop, Vent Pocket

Cable Entrance	Knockouts for 2" conduit on bottom of enclosure
Heating and Cooling	N/A
Grounding	N/A
Powering	N/A
Accessories/ Special Features	Unistruts with spring nuts, and raised back plate

Stock ID	Description	Dimensions	Color	Wt. Lbs.	UOM
050-138-10	30IV Traffic Cabinet	56"H x 30"W x 19"D	Bare	-	Each

Specifications subject to change without notice.

© Multilink, Inc. 2013 • All Rights Reserved

Camera Control Interface



Stock ID: 018-039-20



AC Input Voltage	120 Vac, nominal; single-phase only
Nominal Input Voltage Tolerance	105 to 125 Vac
AC Input Current	1 A @ 120 Vac
Input Frequency	60 Hz, ± 3 Hz
Input Power	100 VA; 115 Watts, max
Input Protection	1.5 Amp, 250 volt, slow blow, glass type fuse

Output Voltage	24 Vac camera power
Output Current	4 A
Output Power	96 VA
Output Protection	4 A, 250 V type AGC-2 fuse (1/4" x 1-1/4" glass tube fuse)

Efficiency	Better than 90% over line voltage range, at full load
-------------------	---

LED Display	Four LEDs on front panel indicate operational status Amber: SYSTEM ON Red: CAMERA ON (2) Green: LOCAL ON (Joystick or RS232)
--------------------	---

Operating Temperature Range	-40°C to +60°C (-40°F to +140°F) at 5% to 95% relative humidity, non-condensing
------------------------------------	---

Mounting Dimensions	19-inch rack mountable EIA/TIA Spacing 18.25-inch mounting centers
----------------------------	---

Size	3.5" H x 17" W x 8.5" D (89mm H x 432mm W x 261mm D)
-------------	---

Weight	Approximately 13 Lbs. (6 Kg)
---------------	------------------------------

EMI / RFI Statement

This device has been designed and manufactured to comply with the limits for a Class A digital device pursuant to Part 15 of FCC Rules. These limits are designed to provide reasonable protection against harmful interference when this equipment is operated in a commercial environment. This equipment generates, uses, and can radiate radio frequency energy and, if not installed in accordance with this instruction manual, may cause harmful interference to radio communications. Operation of this equipment in a residential area may cause interference that the user must correct at its own expense.

*Camera shown above is for illustration purposes only. Not included or available for purchase at Multilink.

Controls, Connections & Indicators

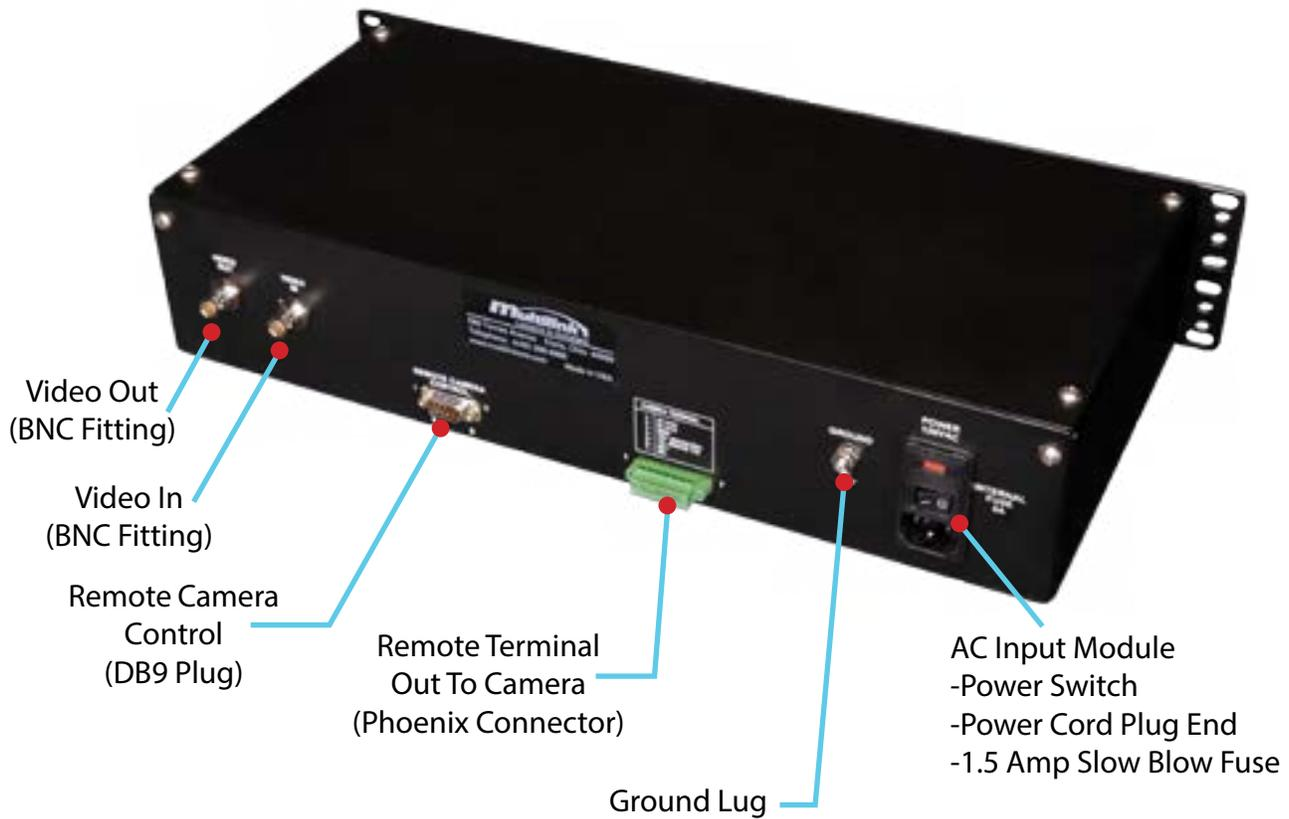

Select Fiber Boxes For DOT



Main unit is offset 15/16" from front of brackets

FRM-1RU-2X-TS-DOT

46

Stock ID	045-586-10 (Black)
Description	Rack Mount 1RU in height made for a 19" or 23" rack width. Features slide-off cover, 2 fixed bulkhead positions, and 2 captive grommets for cable entry.
Dimensions	1.72" H x 12.25" W x 7.68" D (excluding brackets)
Weight	5.1 lbs.
Material	Powder Coated Steel
Capacity	(2) Panels (1) 612-SSTP Splice Tray



FWM-1X-SP

33

Stock ID	045-187-10 / FWM-1X-SP-BK, Black 045-187-11 / FWM-1X-SP-OW, Off White
Description	(1) Multilink Adapter Panels (see individual panel capacities)
Panels	6.30" H x 5.50" W x 1.57" D
Dimensions	(12) Single Splice Holder
Fiber Capacity	18 Gauge Steel
Material	Electrostatic polyester powder coat paint, available in Black & Off White
Coating	



FWM012XPHBK

35

Stock ID	045-178-10 (Black) 045-178-11 (Off White)
Description	Compact indoor wall mount enclosure for inter connectivity and termination of optical fiber
Dimensions	10" H x 8.22" W x 3.81" D
Box Weight	- lbs.
Material	16 GA Gauge Steel
Capacity	(2) Multilink Adapter Panels
Splice Tray	(2) 1120-SSTA



FWM024XLC

02

Stock ID	10-1914 (Black) 10-2714 (Off White)
Description	Wall mount single outer door distribution unit with inner network compartment security door and 4 termination panel capacity
Dimensions	12" H x 12" W x 3.5" D
Box Weight	9 lbs.
Material	18 GA Powder Coated Steel
Capacity	(4) Panels
Splice Tray	(4) 1120-SSTA

Please refer to the Network Product Solutions catalog for additional options

Steel, Stainless Steel, & Aluminum Enclosures



- Multi-Dwelling Units
- Industrial Control Panel
- NEMA Rated
- Junction Boxes

I.D. # _____

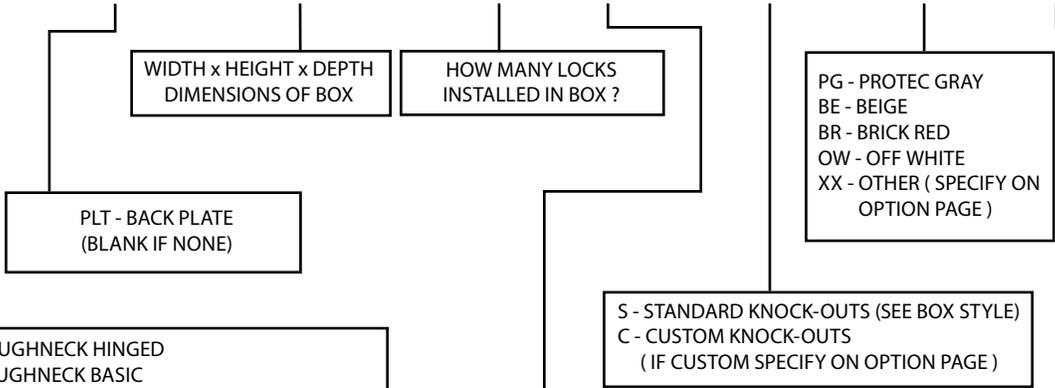
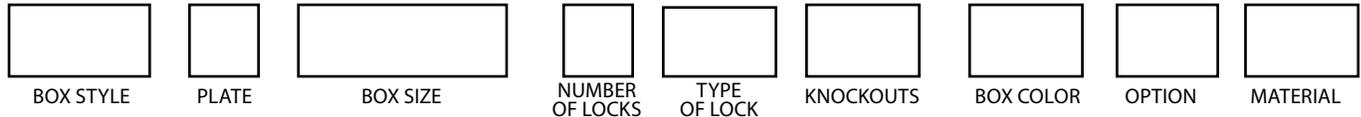

- Pg.**
- 133 RNH - ROUGHNECK HINGED
 - 136 RNB - ROUGHNECK BASIC
 - 134 RNBB - ROUGHNECK BOX-IN-BOX
 - 137 RNHL - ROUGHNECK HANGING-LID
 - 131 M1 - ROUGHNECK ULTRA SERIES
 - 128 RTP - ROUGHNECK TOM PED
 - 135 RNBBH - ROUGHNECK BOX-IN-BOX HINGE
 - 135 RNBBL - ROUGHNECK BOX-IN-BOX LIFT COVER
 - 135 RNBBSH - ROUGHNECK BOX-IN-BOX SUPER HINGE
 - 132 RN2H - ROUGHNECK 2 DOOR HINGE
 - 132 RN1H - ROUGHNECK 1 DOOR HINGE
 - 138 RNHX - ROUGHNECK REMOVABLE DOOR HINGE
 - 127 RNCS - ROUGHNECK SCREW COVER DOOR
 - 126 RN1HN4 - ROUGHNECK NEMA 4 COMPLIANCE
 - 126 RN1HN3R - ROUGHNECK NEMA 3R COMPLIANCE
 - 130 RNSB - ROUGHNECK FLUSH MOUNT PRE-WIRE

- SL - SUPRA
- PL - PLUG
- IL - INNERTITE
- ML - MASTER / DX / MX
- AL - ACE
- DV - STAR PATTERN SCREW
- HA - HASP
- EB - STAR PATTERN SLAM LOCK DESIGN
- HH - 7/16" HEX HEAD (BELCORE 216)
- CAM - 1/4 TURN CAM LOCK
- CV - COMPRESSION VICE 1/4 TURN LATCH
- DL - OVER-CENTER DRAW LATCH
- 3PT - THREE POINT LATCH
- XX - OTHER (SPECIFY)
SEE OPTIONS PAGE FOR LOCK # IF APPLICABLE

- N - NO
- Y - YES (SPECIFY)

- A - ALUMINUM
- S - STEEL
- SS - STAINLESS STEEL

CUSTOM KEY CODES AVAILABLE PER REQUEST

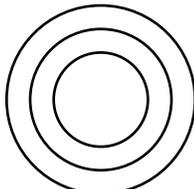

- Round (Conduit) Knockouts**
- A 1-3/8" x 2-15/32"
 - B 7/8" x 1-1/8" x 1-3/4"
 - C 7/8" x 1-1/8" x 1-3/8" x 1-3/4"
 - D 1-3/8" x 1-31/32" x 2-1/2"

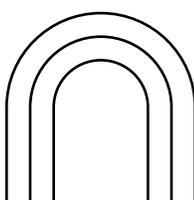

- PVC Riser Guard Knockouts**
- 1.624" x 2.125"
 - 2.156" x 2.625"
 - 2.656" x 3.125"

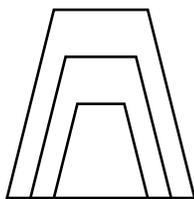

- Trapezoid Knockouts**
- SR075
 - SR100
 - SR200

CONDUIT/KNOCKOUT MATCHING GUIDE		
CONDUIT SIZE	ACTUAL OD	RECOMMENDED KNOCKOUT SIZE
1/2"	.840	7/8"
3/4"	1.060	1-1/8"
1"	1.315	1-3/8"
1-1/4"	1.660	1-11/16"
1-1/2"	1.900	1-31/32"
2"	2.375	2-15/32"
2-1/2"	2.875	2-15/16"
3"	3.5	3-19/32"

Options Page

BOX I.D. # _____

LOCK OPTIONS

TYPE OF LOCK _____

LOCK # _____

SHOULD WAREHOUSE SEND KEYS ?
 YES _____ NO _____

SHOULD THE LOCK BE INSTALLED ?
 YES _____ NO _____

* LIST ANY SPECIAL LOCK INSTRUCTIONS BELOW:

SHIPPING INSTRUCTIONS

BUBBLE WRAP _____

INDIVIDUAL BOX _____

BULK _____

KNOCKOUTS

TYPE OF KNOCKOUT:

A 2 STAGE: 1.375" x 2.46875"

B 2 STAGE: 1.375" x 2.25"

C 2 STAGE: .875" x 1.125" x 1.375" x 1.75"

D 3 STAGE: 1.375" x 1.96875" x 2.5"

J "J" STYLE

P PVC

T TRAPAZOID

R0250 ROUND .250

R0500 ROUND .500

R0562 ROUND .562

R0630 ROUND .630

R1000 ROUND 1.000

R2000 ROUND 2.000

R3000 ROUND 3.000

R4000 ROUND 4.000

*PLEASE SEE ATTACHED PAGE FOR THE LOCATIONS AND TYPE OF KNOCKOUTS FOR THIS BOX

OPTIONAL ACCESSORIES

PLEASE CIRCLE OPTIONS: INSTALL:

D-MARK DROP STAND _____

STAR PLATE _____

SCREEN PLATE _____

RGSB-12 _____

RGSB-18 _____

RGSB-20 _____

RGSB-24 _____

D-MARK _____

OXBOARD _____

PLYWOOD _____

GROUND LUG _____

TAP BRACKET _____

RNRC-100 _____

60078-DRY LID _____

SPECIAL PLATE _____

DOK 1 _____

FANS

AC WIRING _____

DC WIRING _____

RACK RAILS

RACK UNITS _____

THREAD SIZE _____

OTHER _____

NOTES _____

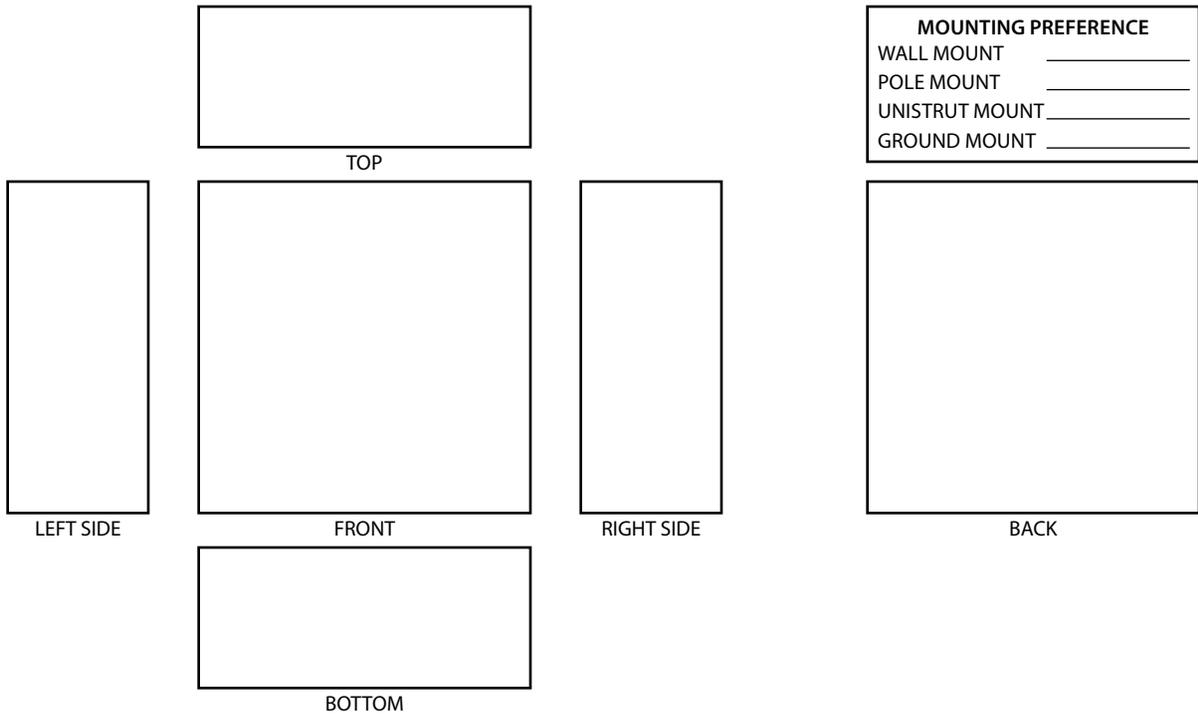

*Select models available UL listed. Contact customer service for more info.

UL Listed Multi-Dwelling Enclosures

The Multilink MDU enclosures listed below have now been UL listed, and NEMA type 1 and 4 approved. The new design features a 216 can wrench compression latch, reversible door, 3/4" plywood backboard, padlockable over center draw latch, and 100% weatherproof gasketing. Standard colors are beige and gray. Mounting bracket sold separately.



Customer Favorite



Stock ID	Description	Dimensions	Color	MOQ
050-152-31	RN1H-24248-1CV-1DL-C-BE-Y-S-INT	24W x 24L x 8D	Beige	EA
050-153-31	RN1H-24244-1CV-1DL-C-BE-Y-S-INT	24W x 24L x 4D	Beige	EA
050-154-31	RN1H-20168-1CV-1DL-C-BE-Y-S-INT	20W x 16L x 8D	Beige	EA
050-155-31	RN1H-20164-1CV-1DL-C-BE-Y-S-INT	20W x 16L x 4D	Beige	EA
050-202-31	RN1H-18148-1CV-1DL-C-BE-Y-S-INT	18W x 14L x 8D	Beige	EA
050-156-31	RN1H-12128-1CV-1DL-C-BE-Y-S-INT	12W x 12L x 8D	Beige	EA
050-152-30	RN1H-24248-1CV-1DL-C-PG-Y-S-INT	24W x 24L x 8D	Gray	EA
050-153-30	RN1H-24244-1CV-1DL-C-PG-Y-S-INT	24W x 24L x 4D	Gray	EA
050-154-30	RN1H-20168-1CV-1DL-C-PG-Y-S-INT	20W x 16L x 8D	Gray	EA
050-155-30	RN1H-20164-1CV-1DL-C-PG-Y-S-INT	20W x 16L x 4D	Gray	EA
050-202-30	RN1H-18148-1CV-1DL-C-PG-Y-S-INT	18W x 14L x 8D	Gray	EA
050-156-30	RN1H-12128-1CV-1DL-C-PG-Y-S-INT	12W x 12L x 8D	Gray	EA

MDU MOUNTING ACCESSORIES

Stock ID	Description	Color	MOQ
072-101-11	MOUNTING BRACKET KIT FOR 24" WIDE RN1H ENCLOSURE	Beige	EA
072-105-11	MOUNTING BRACKET KIT FOR 12", 18" & 20" WIDE RN1H ENCLOSURE	Beige	EA
072-101-10	MOUNTING BRACKET KIT FOR 24" WIDE RN1H ENCLOSURE	Gray	EA
072-105-10	MOUNTING BRACKET KIT FOR 12", 18" & 20" WIDE RN1H ENCLOSURE	Gray	EA

UL Listed Multi-Dwelling Enclosures (Lift-Off Screw Cover)

The Multilink MDU enclosures listed below have now been UL listed, and NEMA type 1 and 4 approved. The new design features a lift-off screw cover and 100% weatherproof gasketing. Standard colors are beige and gray. Mounting bracket sold separately.



Stock ID	Description	Dimensions	Color	MOQ
050-206-31	RNSC-444-SND-TYPE4	4W x 4H x 4D	Beige	EA
050-207-31	RNSC-666-SND-TYPE4	6W x 6H x 6D	Beige	EA
050-208-31	RNSC-6126-SND-TYPE4	6W x 12H x 6D	Beige	EA
050-209-31	RNSC-12126-SND-TYPE4	12W x 12H x 6D	Beige	EA
050-210-31	RNSC-6186-SND-TYPE4	6W x 18H x 6D	Beige	EA
050-211-31	RNSC-18188-SND-TYPE 4	18W x 18H x 8D	Beige	EA
050-206-30	RNSC-444-UG-TYPE4	4W x 4H x 4D	Gray	EA
050-207-30	RNSC-666-UG-TYPE4	6W x 6H x 6D	Gray	EA
050-208-30	RNSC-6126-UG-TYPE4	6W x 12H x 6D	Gray	EA
050-209-30	RNSC-12126-UG-TYPE4	12W x 12H x 6D	Gray	EA
050-210-30	RNSC-6186-UG-TYPE4	6W x 18H x 6D	Gray	EA
050-211-30	RNSC-18188-UG-TYPE 4	18W x 18H x 8D	Gray	EA

MDU MOUNTING ACCESSORIES

Stock ID	Description	Color	MOQ
072-126-11	MOUNTING BRACKET KIT FOR 4" WIDE ENCLOSURE	Beige	EA
072-125-11	MOUNTING BRACKET KIT FOR 6" WIDE ENCLOSURE	Beige	EA
072-126-10	MOUNTING BRACKET KIT FOR 4" WIDE ENCLOSURE	Gray	EA
072-125-10	MOUNTING BRACKET KIT FOR 6" WIDE ENCLOSURE	Gray	EA

Tom Ped Double Box Pedestal

High Security Protection



Available in Steel or Aluminum

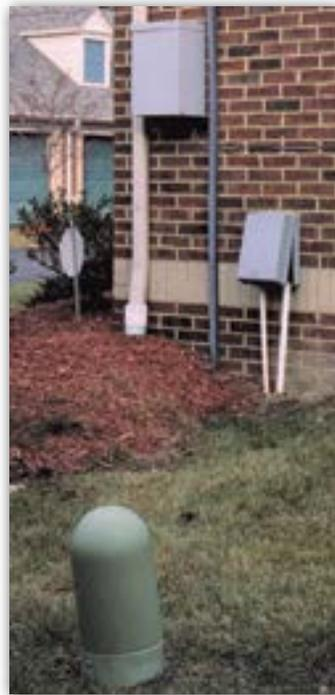

Tom Ped is the answer to these types of MDU problems.

- INCREASED SECURITY
- DECREASED COST
- CLEANER INSTALLATION

Application

The only hybrid high security box-in-box and pedestal enclosure. Designed for broadband multimedia systems.

This concept offers two levels of high security against illegal hook-ups, and keeps your cable well managed. Can be firmly bolted to the wall or staked to the ground.

Features & Benefits

- Box-in-box design.
- Can be keyed to match any manufacturer's locking system
- Built to last with high-grade construction materials
- 100% fusion welded construction for greater durability and quality control of welds
- Textured steel holds paint better.
- Gray baked-on polyester powder coating
- Scratch and salt spray tested
- ASTM rating

Standard Knockouts

- No Knockouts
- Removeable Bottom Plate for front access and open bottom

Recommended Sizes (W x H x D)

- 16" x 42" x 8"
- 15" x 40" x 8"
- 12" x 36" x 8"
- 8" x 32" x 8"

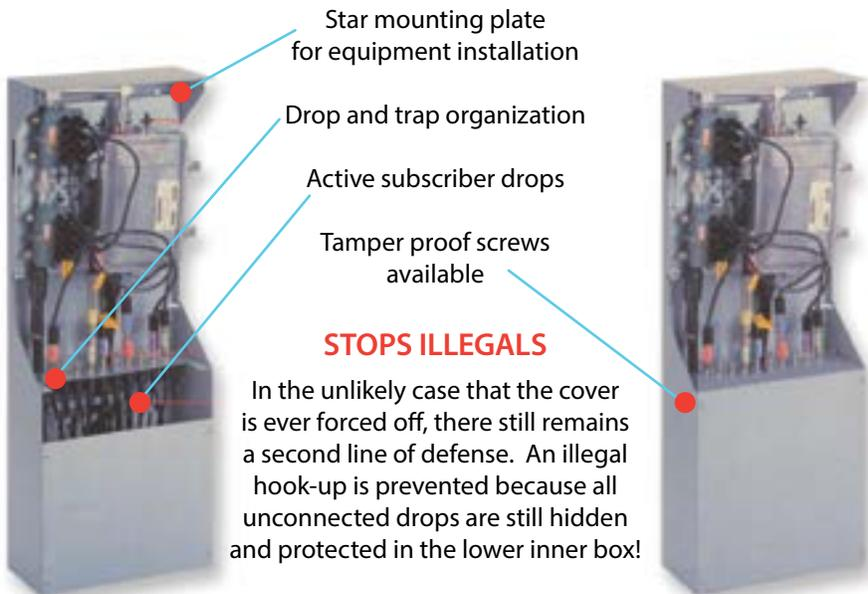

Tom Ped Double Box Pedestal High Security Protection



RTP Hinged Door Style

Includes 3 heavy duty slip hinges for maintenance ease. Above box features a tamper-proof screw slam lock.



RTP Box-in-Box Style With Cut Away Sides

Shown with adjustable star and D-Mark plate. Features tamper-proof screw slam lock.



RTP Box-in-Box Style Pedestal With Full Sides

Box includes D-Mark plate with two mounting options. Also available with star plate and various locking options. Please call Customer Service for more information.



Customized Lock

Stock ID	Description	Dimensions	UOM
12824	BS-24 Pedestal Stake For Tom Ped Double Box Pedestal	24"	Each
12832	BS-32 Pedestal Stake For Tom Ped Double Box Pedestal	32"	Each
12845	BS-42 Pedestal Stake For Tom Ped Double Box Pedestal	42"	Each
12833	RN-TPTB Tom Ped Tap Bracket	-	Each

Please call Customer Service for custom sizes, configurations, and lock specifications

Flush Mount Pre-Wire Box

For New and Post Construction Applications



Applications

Make pre-wiring jobs easier with a Flush Mount Pre-Wire box from Multilink. It's designed for use in common junction locations for pre-wiring in new and post construction applications. It mounts easily to the stud and is adjustable to any size drywall.

Features & Benefits

- Comes complete with mounting hardware
- Can be used in both new and post-construction applications
- Mounts easily to studs and is adjustable to accommodate all sizes of drywall
- Two knockouts on both top and bottom
- Cover is coated with durable white powder coating
- Custom logos and imprints are available

Stock ID	Description	Knockouts	Dimensions	UOM
10799K	RNSB-69 Flush Mount Pre-wire Box (MOQ 25pcs.)	2 Top / 2 Bottom / .875"	9.5" H x 6.5" W x 2.5" D	Each
11568K	RNSB-1214 Flush Mount Pre-wire Box w/Plywood (MOQ 25pcs.)	3 Top / 3 Bottom / .875"	12" H x 14" W x 3" D	Each
060-005-10	RNSB-12143 Flush Mount Pre-wire Box (MOQ 25pcs.)	3 Top / 3 Bottom / .875"	12" H x 14" W x 3" D	Each
045-197-10	Flush Mount Pre-wire Box (MOQ 25pcs.)	3 Top/2 Bottom / Dual Stage 1.375" & 2.25"	20" H x 14.125" W x 4" D	Each

All stock codes listed are for standard options only
Please call Customer Service for custom sizes, configurations, and lock specifications

M1™ Ultra Series

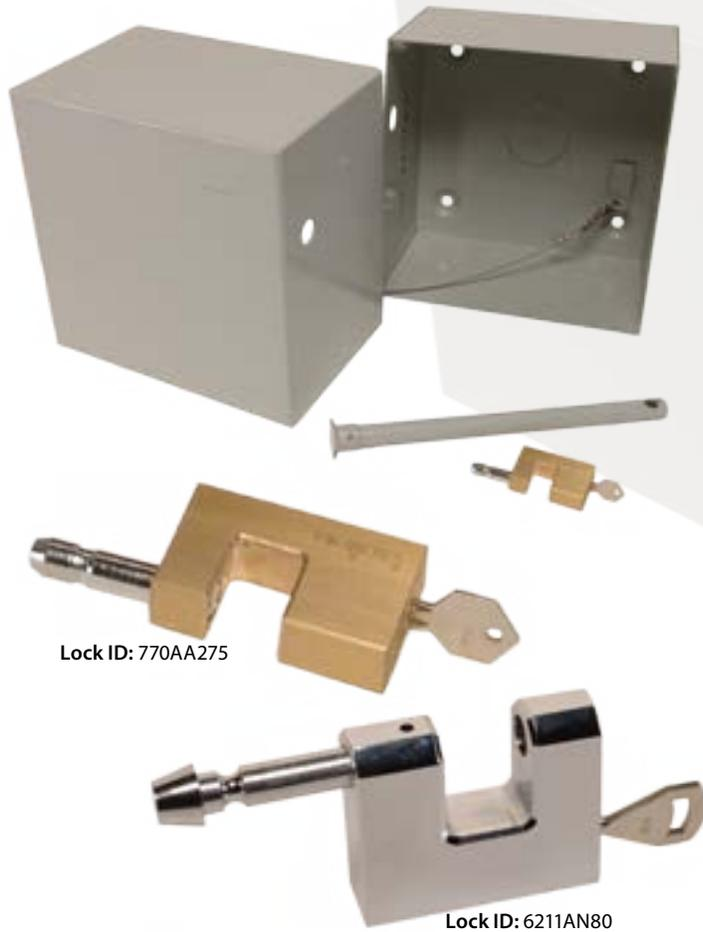

Step up to a new level in high security steel enclosures with the M1™ ultra high security MDU steel enclosure.

Applications

The heavy duty box-in-box design combined with the unique hardened steel security bar closure assembly makes the M1™ as tough as a tank!

Features & Benefits

The M1™ Ultra Series is constructed with the cover robotically seam welded, a feature not offered by any other steel enclosure manufacturer in the Cable TV industry! The key to the higher level of security offered by the M1™ Ultra Series box is in the 7/8" diameter steel Ultra Bar which runs through the steel inner bottom and cover of the box and features a 1/2" shackle hole ready to accept practically any high security padlock. With so many features packed into a single steel enclosure it is easy to see why the new M1™ Ultra Series box is the ultimate in high security steel enclosures!

Standard Knockouts

- 1 Back / (D Size)

Recommended Sizes (W x H x D)

- 12" x 12" x 8"
- 12" x 18" x 8"
- 15" x 18" x 8"
- 18" x 24" x 8"

Stock ID	Description	Box Width	Lock ID	UOM
10-5476	M1-12 Hardened Steel Security Bar	12"	770AA275	Each
10-5477	M1-15 Hardened Steel Security Bar	15"	770AA275	Each
10-5480	M1-18 Hardened Steel Security Bar	18"	770AA275	Each
10-7232	M1-8 Extended Hardened Steel Security Bar	8"	6211AN80	Each
10-5488	M1-12 Extended Hardened Steel Security Bar	12"	6211AN80	Each
10-5491	M1-15 Extended Hardened Steel Security Bar	15"	6211AN80	Each
10-5494	M1-18 Extended Hardened Steel Security Bar	18"	6211AN80	Each
10-5960	M1-24 Extended Hardened Steel Security Bar	24"	6211AN80	Each
12709	Roughneck Lid Retaining Cable With 1 Hook	-	-	Each
12712	Roughneck Lid Retaining Cable With 2 Hooks	-	-	Each

Stock codes vary depending on options such as locks and other accessories
Please call Customer Service for custom sizes, configurations, and lock specifications

RN2H/RN1H



RN2H Shown with optional Oxboard & Single Compartment



Features & Benefits

- Now available in depths of 10" and 15"
- Available in aluminum
- Hinged 2-door cover
- Gray baked-on polyester powder coating

Options

- 2 separated compartments
- Standard accessories
- Various locking hardware
- Standard knockouts, size and location
- Voice port mounting plates

Standard Knockouts

- 4 Bottom / 1 Side / 1.375" x 2.468" Knockouts

Recommended Sizes (W x H x D)

- 18" x 24" x 8"
- 24" x 24" x 8"
- 36" x 36" x 8"



RN2H Shown with One Compartment

RNH Hinged Series Enclosures



Features & Benefits

- Hinged cover
- Baked-on polyester powder coating for high corrosion resistance
- Knockout for optional Cam Lock
- Multiple entry knockouts
- Indented mounting holes for easy installation
- 3/4" D-Knockout
- Drain holes to keep moisture out
- Available with Star Slam Lock
- Available with back plate option. Add "PLT" to Box Style. Knockouts will change to PVC Style.

RNH Box with Drop Stand/Organizer Option



Uses same replaceable hasp system as RNB series boxes

Recommended Sizes (W x H x D)	Standard Knockouts	
	Knockouts	Sizes
RNH-10126	2 Bottom	1 Size A / 1 Size C
RNH-12128	2 Bottom	1 Size A / 1 Size C
RNH-12188	3 Bottom	2 Size A / 1 Size C
RNH-15188	3 Bottom	2 Size A / 1 Size C
RNH-20248	3 Bottom	2 Size A / 1 Size C
RNH-24368	3 Bottom	2 Size A / 1 Size C
RNH-36368	3 Bottom	2 Size A / 1 Size C

RNBB - Box-In-Box High Security Series Enclosure

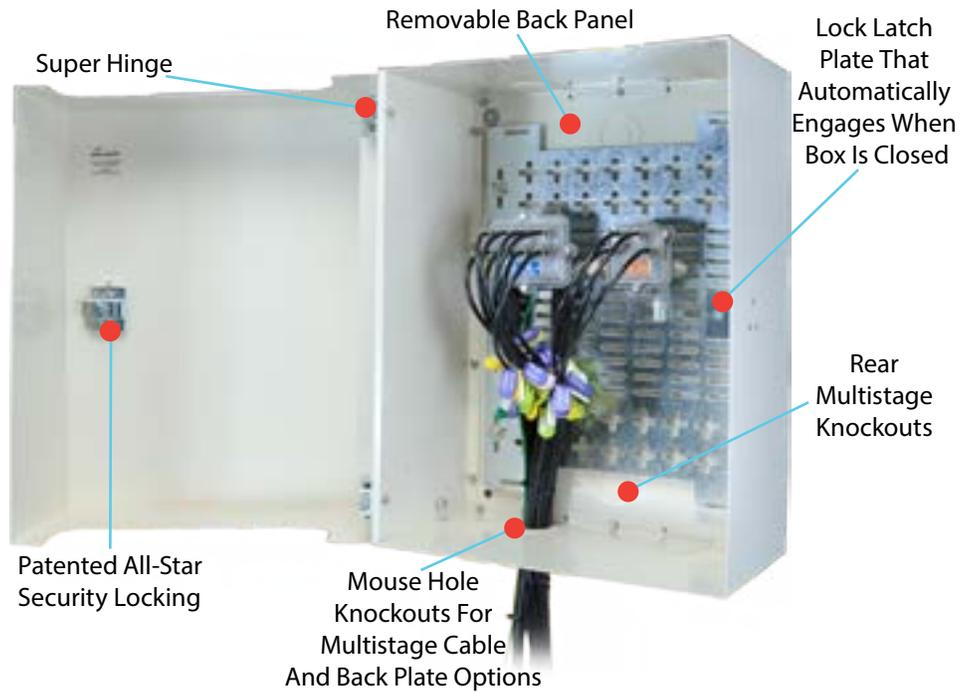

Features & Benefits

- High security bearing sleeve at locking point
- Highly durable polyester powder coat finish for high corrosion resistance
- Full back with multiple entry knockout
- Key style mounting holes for easy installation
- Drain holes to keep moisture out
- Available with Star Slam Lock
- MX and DX locking keyways available
- Available in steel or aluminum
- If aluminum is desired, add an "A" to the end of the part number
- Available with back plate option. Add "PLT" to Box Style Knockouts will change to PVC Style.



Patented All-Star Security Latch Compatible



RNBB Box-in-Box

High Security Series Enclosures



Standard Knockouts

- 2 Bottom / 2 Back / 2 Top / "A" Size

Recommended Sizes (W x H x D)

- 12" x 12" x 8"
- 12" x 18" x 8"
- 15" x 18" x 8"
- 18" x 24" x 8" (Not Available For RNBBH)

Stock codes vary depending on options such as locks and other accessories
Please call Customer Service for custom sizes, configurations, and lock specifications



Shown with Lift Cover (RNBBL)

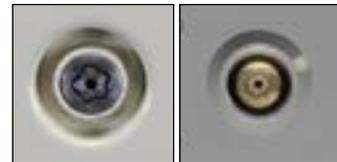

All-Star Latch and Star Pattern Latch Compatible



Shown Closed (RNBB)

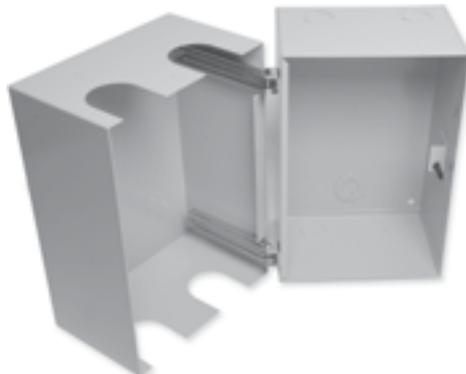

Shown with Super Heavy Duty Hinge Option (RNBBSH)



Shown with Standard Hinge Option (RNBBH)

RNB Series Enclosures



Features & Benefits

- Gray baked-on polyester powder coating for high corrosion resistance
- Knockout for optional Cam Lock
- Multiple entry knockouts
- Indented mounting holes for easy installation
- 3/4" D-Knockout
- Drain holes to keep moisture out
- Available with back plate option. Add "PLT" to Box Style. Knockouts will change to PVC Style.



Zinc chromate, replaceable hasp, standard with every RNB series box.

Recommended Sizes (W x H x D)

- 8" x 12" x 6"
- 12" x 12" x 8"
- 12" x 18" x 8"
- 15" x 18" x 8"

Recommended Sizes (W x H x D)	Standard Knockouts	
	Knockouts	Sizes
RNB-8126	2 Bottom	2 Size C
RNB-12128	2 Bottom	1 Size B / 1 Size C
RNB-12188	3 Bottom	1 Size B / 2 Size C 2 Each Side / 2 Size C
RNB-15188	3 Bottom	1 Size B / 2 Size C 2 Each Side / 2 Size C
RNB-24188	4 Bottom	2 Size B / 2 Size C 2 Each Side / 2 Size C

Stock codes vary depending on options such as locks and other accessories
Please call Customer Service for custom sizes, configurations, and lock specifications

RNHL Hanging Lid Series Enclosure



Features & Benefits

- Can be set up with a variety of cylinder locks, the Innertite Lock, or a tamper proof screw
- Gray baked-on polyester powder coating for high corrosion resistance
- Multiple entry knockouts
- Drain holes available to keep moisture out
- Available with back plate option. Add "PLT" to Box Style. Knockouts will change to PVC Style.

Standard Knockouts

- 2-4 Bottom / 1 Side / B & C Size

Recommended Sizes (W x H x D)

- 8" x 10" x 6"
- 10" x 10" x 6"
- 12" x 12" x 8"
- 12" x 18" x 8"
- 15" x 18" x 8"
- 18" x 24" x 8"
- 24" x 24" x 8"

Multilink is the only manufacturer of steel enclosures that offers built-in drain holes as a standard throughout the entire product line. Stock codes vary depending on options such as locks and other accessories. Please call Customer Service for custom sizes, configurations, and lock specifications.

RNHX Side Swing Hinge Series Enclosure



Special heavy duty grommets, shown above, are now available on all MDU steel units.

Features & Benefits

- Can be set up with a variety of Cylinder Locks, the Inertite Lock, or a tamper proof screw
- Gray baked on polyester powder coating for high corrosion resistance
- Multiple entry knockouts
- Drain holes keep moisture out
- Available with back plate option. Add "PLT" to Box Style. Knockouts will change to PVC Style.

Standard Knockouts

- 2-4 Bottom / 1 Side / B & C Size

Recommended Sizes (W x H x D)

- 12" x 12" x 10"
- 12" x 18" x 10"
- 15" x 18" x 10"
- 18" x 18" x 10"
- 18" x 24" x 10"

Part#	Description	UOM
10-6499	Short, Single Hole MDU Grommet	Each
10-5864	Long, Two Hole MDU Grommet	Each
642-039-10	Long, Snap Fit PVC MDU Grommet	Each

Please call Customer Service for more information
 Stock codes vary depending on options such as locks and other accessories
 Please call Customer Service for custom sizes, configurations, and lock specifications

PLT Option

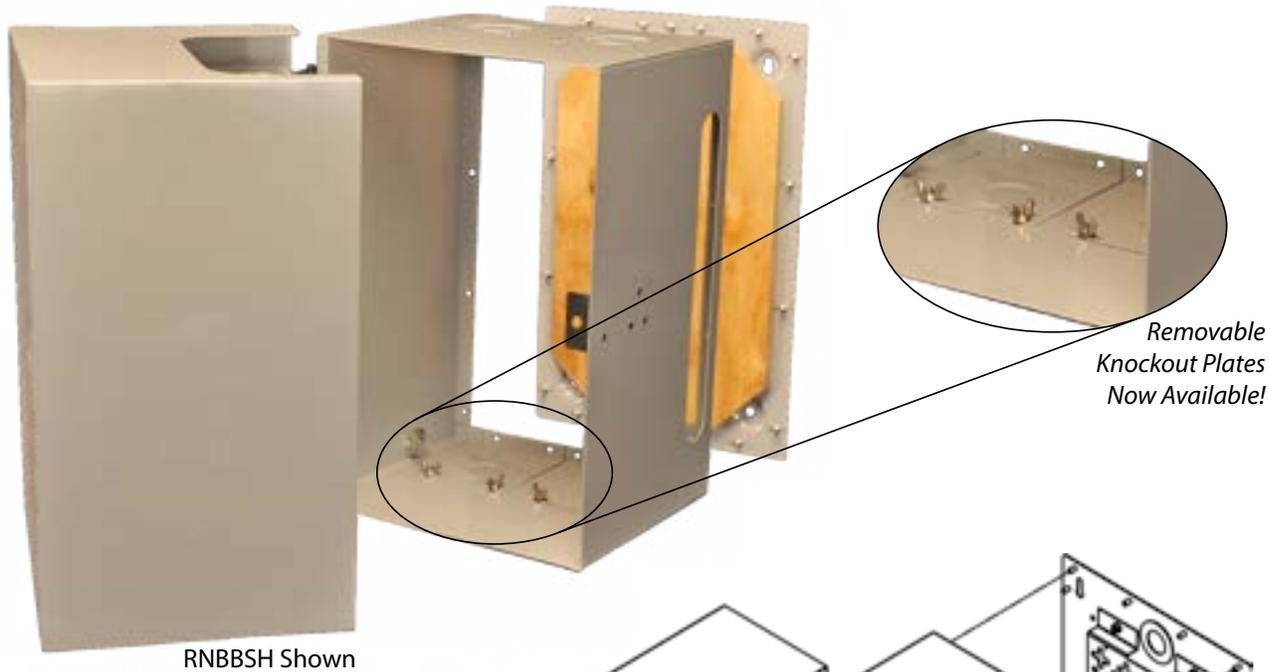

RNBBSH Shown

Features & Benefits

- Back plate can remain mounted to wall during maintenance to allow your customer uninterrupted service
- Baked-on powder coating for high corrosion resistance
- Drain holes to keep moisture out
- Designed with PVC style knockouts to accommodate a quick and easy separation from back plate
- Available in steel or aluminum

Standard Knockouts

- 2 Bottom / 2 Back / 2 Top / "A" Size

Recommended Sizes (W x H x D)

- 12" x 12" x 8"
- 12" x 18" x 8"
- 15" x 18" x 8"
- 18" x 24" x 8"

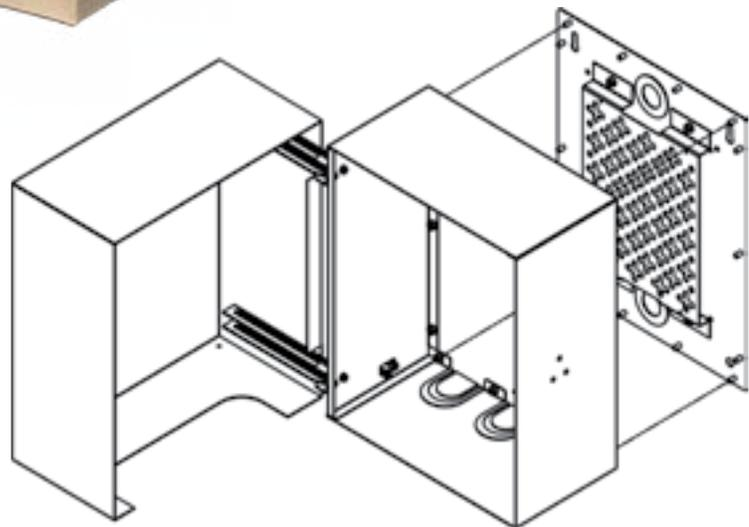

PLT Available w/ These Box Styles

- RNH - ROUGHNECK HINGED
- RNB - ROUGHNECK BASIC
- RNBB - ROUGHNECK BOX-IN-BOX
- RNHL - ROUGHNECK HANGING-LID
- M1 - ROUGHNECK ULTRA SERIES
- RTP - ROUGHNECK TOM PED
- RNBBH - ROUGHNECK BOX-IN-BOX HINGE
- RNBBSH - ROUGHNECK BOX-IN-BOX SUPER HINGE
- RN2H - ROUGHNECK 2 DOOR HINGE
- RN1H - ROUGHNECK 1 DOOR HINGE
- RNHX - ROUGHNECK REMOVABLE DOOR HINGE
- RNSC - ROUGHNECK SCREW COVER

The Multilink Tamper Proof Drivers & Screws

Tamper Proof Screw Drivers made from hardened steel, plated in Zinc Chromate
Each style can be customized with any pattern drive!



Bend Style With
Off Center Drive



"T" Style With
Star Pattern Drive



Classic Driver Style With
Eccentric Drive



Off Center Pin



Custom Star Pattern
(Your Custom Pattern Awaits!)



Eccentric Screw

Star/Slam Lock screw available in custom pattern
Call Customer Service for more information



RNI High Security Locking Systems For Roughneck Steel Enclosures



The MX High Security Customized Locking System-DX Compatible

- The most secure lock ever developed specifically for the Cable TV industry
- Fully compatible with pre-existing DX keyways.
- The unique, patented dual pin design makes the MX the most reliable lock in the industry



IL- Inner-Tite® Barrel Lock and Key



Inner-Tite® Agbay Barrel Lock & Key



Van Lock Cam Lock & Key



Block Lock & Key

Lock part numbers vary depending on type, key way, etc.
Please call Customer Service for more information

Options and Accessories



Van Lock Plug Lock

Self-locking CPLM1 is available in Cable Plug Lock-Master Series and CPLV Cable Plug Lock-Vanamatic (8 in 1).



Master Pad Lock

Multilink is a full line distributor of the most trusted locks in the world, the Master Padlock with (2) keys.



Let's Talk Security

Optional logo/six-digit code. Now you can track and know where your keys and drivers are!



Plastic Supra Lock Dry Lid



SL- Supra Lock



Customized Lock

Features & Benefits

- Reduce passing/transferring of keys
- Keep track of your security
- Track theft of service
- When issuing keys and drivers you can track by six-digit security with employees and subcontractors
- Available on keys and tamper-proof drivers

Ace/Chicago and American Locks with customized key codes can be ordered through Multilink

Multilink is a full line distributor of American Locks

The Multilink data bank tracks all keys and drivers sold by six-digit number system

For more details, please call Customer Service. Lock part numbers vary depending on type, key way, etc.

Options and Accessories



A - Screen Plate



B - Oxboard



C-G - Touch-Up Paint



H - Star Plate



I - Mark Plate



J - Ground Lug

Figure	Stock ID	Description	Dimensions	UOM
A	Varies	Screen Plate	Sized to Fit	Each
B	Varies	Oxboard Backing	Sized to Fit	Each
C	12715	Brown Touch-up Paint	12oz.	Each
D	12716	Beige Touch-up Paint	12oz.	Each
E	12717	Brick Red Touch-up Paint	12oz.	Each
F	12718	White Touch-up Paint	12oz.	Each
G	12719	Grey Touch-up Paint	12oz.	Each
H	Varies	Star Plate	Sized to Fit	Each
I	Varies	D-Mark Plate For Roughneck Steel Enclosures	-	Each
J	12704K	Ground Lug	-	Each
N/A	Varies	Copper Bus Bar	-	Each

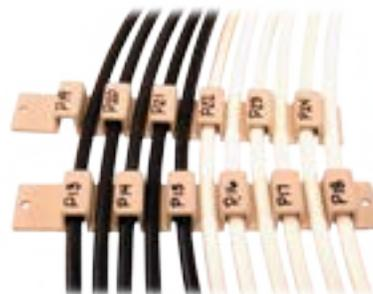

Stock ID	Description	Size	Color	UOM
649-009-10	Cable Organizer	12.7mm	Ivory	Each
649-010-10	Cable Organizer	8.5mm	Ivory	Each

Options and Accessories for Roughneck Steel Enclosures



Optional louvers available on your MDU, please call Customer Service for more information



Keep from losing the detachable lids from your Roughneck Steel Enclosure with this high strength retaining cable with eyelets



New Tap Mounting Bracket Mount taps quickly and easily inside your roughneck box

Part#	Description	UOM
12709	Roughneck Lid Retaining Cable With 1 Hook	Each
12712	Roughneck Lid Retaining Cable With 2 Hooks	Each
12708K	RNBT-7 Tap Bracket	Each

Why does Multilink use Galvanealed Steel vs. Aluminized Steel in the construction of our Steel MDU Enclosures?

Galvanealed Steel - Starzinc-Alloy

Features

- Uniform zinc coated steel sheets feature paint adhesion quality not found in other coated steel sheets
- Surface roughness encourages paint adhesion and provides base for finishing

Uses

- **Automobile**
Underbody parts, reinforcing parts
- **Outdoor**
Roofing, siding, shutters, doors, and traffic signs
- **Indoor**
Air conditioner housings, commercial refrigerators, washing machines, steel furniture, office machines, furnaces, and ovens

Aluminized Steel - Al-Might

Features

- Aluminum coated steel sheets offer high-grade resistance to corrosion and heat
- Excellent heat reflective and good formability
- Beautiful finish even under high temperature

Uses

- **Automobile**
Exhaust pipes, mufflers, catalytic converters, auto heat shields
- **Indoor**
Chimneys, fireplaces, stoves, heat exchangers, water heaters, furnaces, barbecue grills, ovens, and toasters

	Coating Corrosion Resistance	Fire Retardant Resistance	Heat Resistance	Formability	Weldability	Paintability
Galvanealed Steel Starzinc-Alloy	High	Low	Low	High	High	High
Aluminized Steel Al-Might	Low	High	High	Low	Low	Low

• indicates product suitable for
•• indicates greater product suitability

Multilink's Family Of Plastic Demarcation Enclosures



Non-Captive Plastic Demarcation Enclosure

CC-1/JR, CC-1/DWB, and CC-1/110-T



Features & Benefits

- Dual locking system
- Guard Tower locking terminator
- Replaceable hasp
- Custom Logos/Imprints
- Injection Molded available
- Have it your way, we customize to your application!

Patent #331-740

Stock ID	Description	Dimensions	Wt. Lbs./Case	UOM
30125K	CC-1/JR-T Set Up for Locking Terminator Use	7.375" H x 4.75" W x 1.625" D	26 lbs.	50/Case
30105K	CC-1/DWB-T	9.85" H x 6.75" W x 3.7" D	25 lbs.	30/Case
30307K	CC-1/DWB-TS Tamper Proof Screw	9.85" H x 6.75" W x 3.7" D	25 lbs.	30/Case
30155K	CC-1/110-T Set Up for Locking Terminator Use	11" H x 7.0" W x 4.25" D	38 lbs.	30/Case
31440	C-1PC Terminator Cap for CC-1 Enclosures-Gray	-	-	Each

SDU9134 (Single Dwelling Unit) Non-Captive Plastic Demarcation Enclosure

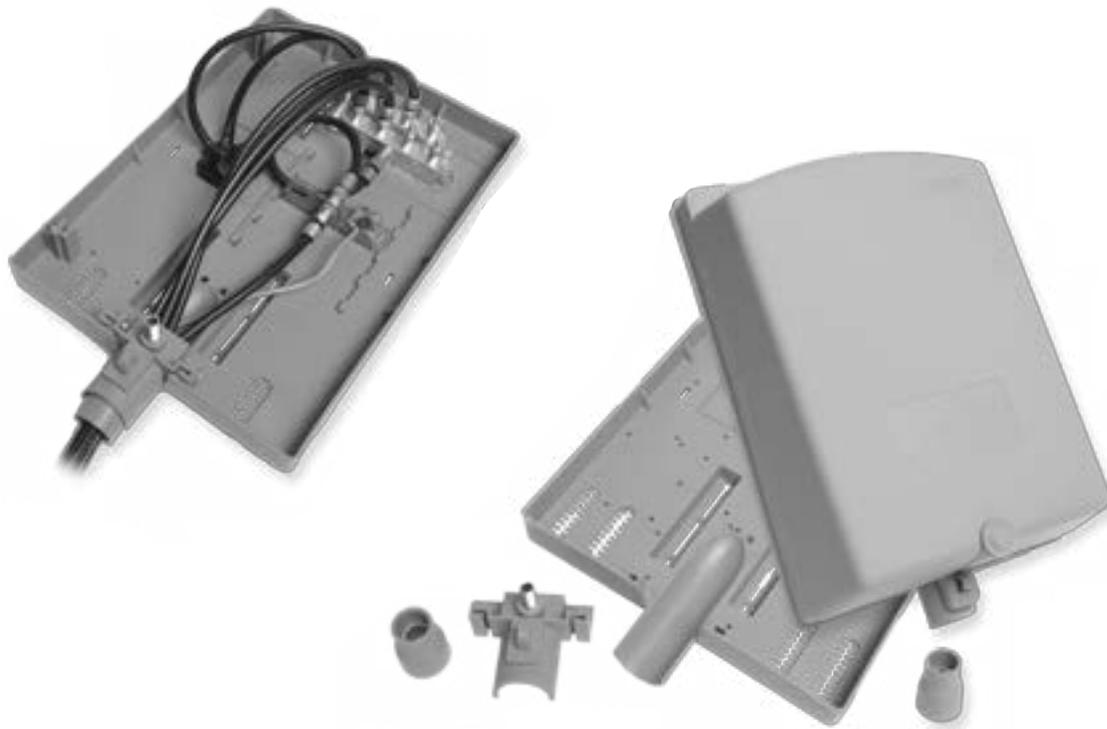

The SDU is more than a plastic enclosure. The innovative, NON CAPTIVE design speeds the upgrade installation time of installing a new demarcation enclosure without disconnecting the customer's service!

Features & Benefits

- Guard Tower locking terminator
- Replaceable Hasp
- Custom Logos/Imprints
- Injection molded available
- Standard color is gray

Stock ID	Description	Dimensions	Wt. Lbs./Case	UOM
30211K-T	SDU-9134 Set up with replaceable hasp and locking terminator security post	13.85" H x 9.31" W x 4" D	19 lbs.	10/Case
30222K	SDU-9134 Set up with replaceable hasp and locking terminator security post - Features Deep Lid	13.85" H x 9.31" W x 5" D	16 lbs.	8/Case

SDU-9134 features tamper proof screws 10/Case

Indoor/Outdoor Wall Enclosure RNI-1000



The RNI-1000 series enclosure is constructed with UV stabilized plastic, standard gray color. Removable door has dual locking systems and accepts custom logos/imprints. Cable entry points can be found on the bottom of this enclosure. Countersunk mounting holes for easy mounting on uneven surfaces.

INDOOR/OUTDOOR WALL ENCLOSURE - RNI-1000

Stock ID	020-027-20
Description	Indoor/Outdoor Wall Enclosure RNI-1000
Dimensions	9.9" H x 10.52" W x 3.27" D
Capacity	7.5" H x 8.0" W x 1.75" D
Material	UV Stabilized Plastic, Gray (can be painted with latex paint)
Cable Entry	Multiple Entry Points at Bottom of Enclosure
Weight	34 lbs. per case
UOM	20 per case

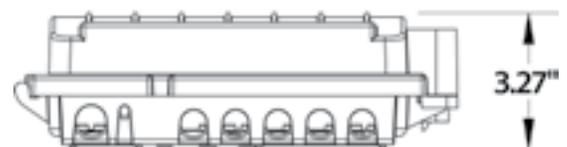
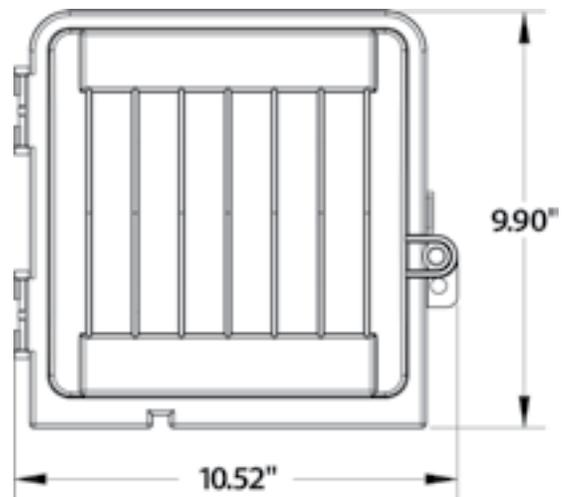

Indoor/Outdoor Wall Enclosure RNI-1200



FlexGrid™ back design for universal mounting

Patent in process



Customer Favorite

The RNI-1200 series enclosure is constructed with UV stabilized plastic, standard gray color. Removable door has dual locking systems and accepts custom logos/imprints. Cable entry points can be found on the bottom of this enclosure. Countersunk mounting holes for easy mounting on uneven surfaces. Back wall incorporated FlexGrid™ arrangement, which incorporates mounting slots for greater flexibility in mounting more products. Slots accept #6 & #8 screws.

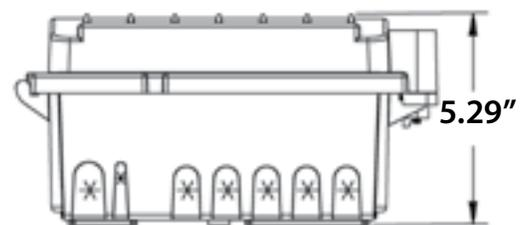
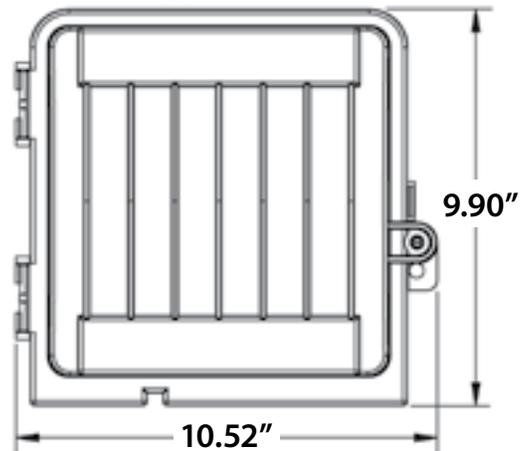

INDOOR/OUTDOOR WALL ENCLOSURE - RNI-1200

Stock ID	020-070-20
Description	Indoor/Outdoor Wall Enclosure RNI-1200
Dimensions	9.90" H x 10.52" W x 5.29" D
Capacity	7.5" H x 8.0" W x 4" D
Material	UV Stabilized Plastic, Gray (can be painted with latex paint)
Cable Entry	Multiple Entry Points at Bottom of Enclosure
Weight	13 lbs. per case
UOM	10 per case

Indoor/Outdoor Wall Enclosure RNI-1500



The RNI-1500 series enclosure is constructed with UV stabilized plastic, standard gray color. Removable door has dual locking systems and accepts custom logos/imprints. Cable entry points can be found on the bottom of this enclosure. Countersunk mounting holes for easy mounting on uneven surfaces.

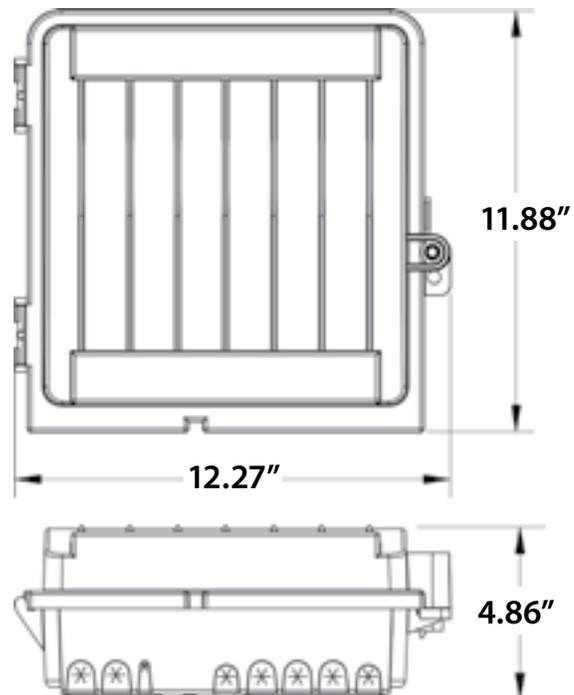

INDOOR/OUTDOOR WALL ENCLOSURE - RNI-1500

Stock ID	020-028-20
Description	Indoor/Outdoor Wall Enclosure RNI-1500
Dimensions	11.88" H x 12.27" W x 4.86" D
Capacity	9.5" H x 9.5" W x 3.25" D
Material	UV Stabilized Plastic, Gray (can be painted with latex paint)
Cable Entry	Multiple Entry Points at Bottom of Enclosure
Weight	20 lbs. per case
UOM	10 per case

Indoor/Outdoor Wall Enclosure RNI-2000



The Multilink RNI-2000 plastic demarcation enclosure provides the ultimate mounting flexibility of our FlexGrid™ mounting system. FlexGrid™ equipped boxes are guaranteed to fit any manufacturers splitter footprint. Mounting area of approximately 9" wide and 6" high provides unsurpassed mounting capability. The specialized grommet strip provides added weatherproofing along with an industry standard locking terminal for security of contents.

INDOOR/OUTDOOR WALL ENCLOSURE - RNI-2000

Stock ID	020-115-20
Description	Indoor/Outdoor Wall Enclosure RNI-2000
Dimensions	11.92" H x 12.27" W x 4.91" D
Capacity	9.5" H x 9.5" W x 3.25" D
Material	UV Stabilized Plastic, Gray (can be painted with latex paint)
Cable Entry	Multiple Entry Points at Bottom of Enclosure
Weight	20 lbs. per case
UOM	10 per case

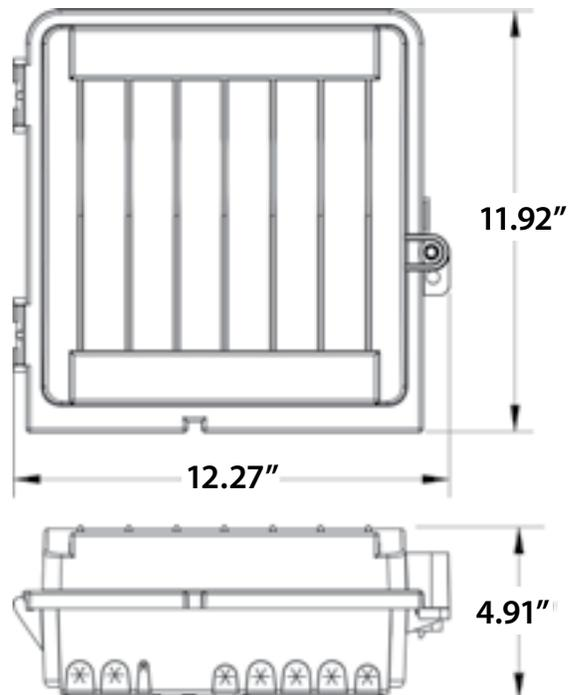

Indoor/Outdoor Wall Enclosure RNI-2500



The Multilink RNI-2500 plastic demarcation enclosure provides the ultimate mounting flexibility of our FlexGrid™ mounting system. FlexGrid™ equipped boxes are guaranteed to fit any manufacturer's splitter footprint. Four raised mounting blocks allow for a second level mounting plate to be installed above the base level of the enclosure. Specialized grommets and a main cable tie-down location provide added security along with industry standard locking terminal.

INDOOR/OUTDOOR WALL ENCLOSURE - RNI-2500

Stock ID	020-104-20
Description	Indoor/Outdoor Wall Enclosure RNI-2500
Dimensions	12.95" H x 12.37" W x 4.90" D
Capacity	9.75" H x 9.75" W x 3.75" D
Material	UV Stabilized Plastic, Gray (can be painted with latex paint)
Cable Entry	Multiple Entry Points at Bottom of Enclosure
Weight	20 lbs. per case
UOM	10 per case

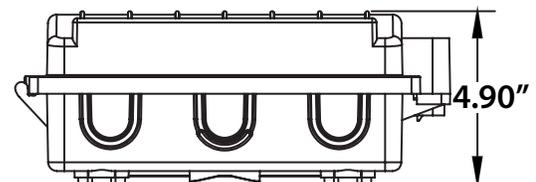
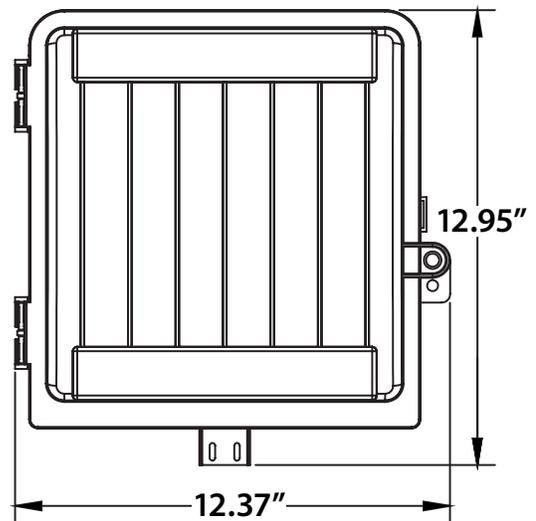

Indoor/Outdoor Wall Enclosure RNI-2600



FlexGrid™ back design for universal mounting

Patent in process

The Multilink RNI-2600 plastic demarcation enclosure provides the ultimate mounting flexibility of our FlexGrid™ mounting system. FlexGrid™ equipped boxes are guaranteed to fit any manufacturers splitter footprint. Mounting area of approximately 9" wide and 6" high provides unsurpassed mounting capability. The specialized grommet strip provides added weatherproofing along with an industry standard locking terminal for security of contents.

INDOOR/OUTDOOR WALL ENCLOSURE - RNI-2600

Stock ID	020-160-20
Description	Indoor/Outdoor Wall Enclosure RNI-2600
Dimensions	11.92" H x 12.29" W x 4.91" D
Capacity	9.5" H x 9.5" W x 3.25" D
Material	UV Stabilized Plastic, Gray (can be painted with latex paint)
Cable Entry	Multiple Non-Captive Entry Points at Bottom of Enclosure
Weight	20 lbs. per case
UOM	10 per case

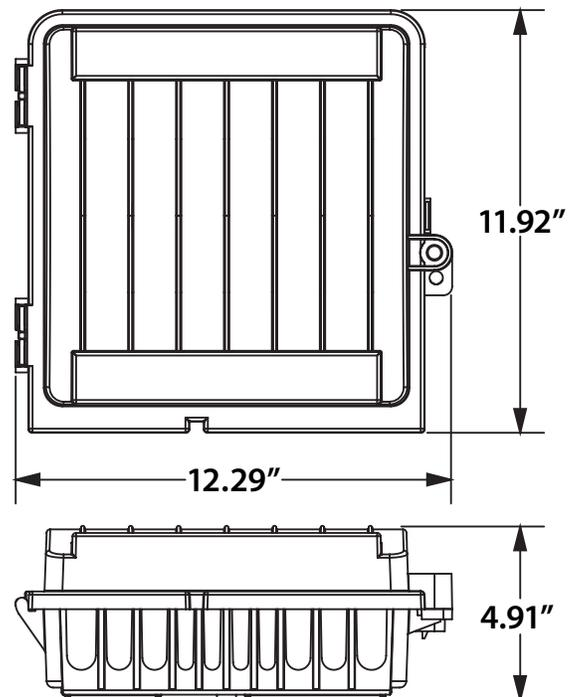

Multimedia Single Door Plastic Demarcation Enclosure



Features & Benefits

- Dual locking system
- Removable cover
- Plywood Optional
- UV stabilized plastic can be painted with Latex paint
- Countersunk mounting holes for easy mounting on uneven surfaces like aluminum or vinyl siding
- Standard color is Gray
- Custom Logos/Imprints
- Injection molded available

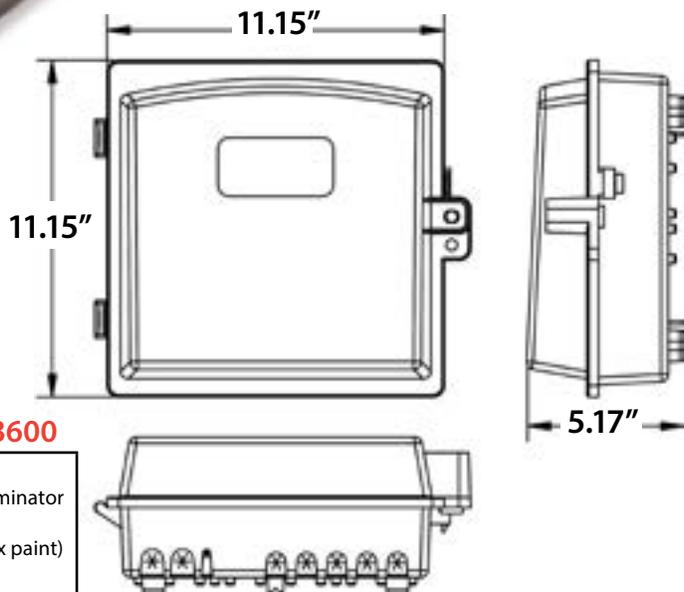

INDOOR/OUTDOOR WALL ENCLOSURE - RNI-3600

Stock ID	30617K
Description	Single Door Demarkation Enclosure w/ Locking Terminator
Dimensions	11.5" H x 11.5" W x 5.17" D
Material	UV Stabilized Plastic, Gray (can be painted with latex paint)
Cable Entry	Multiple Entry Points at Bottom of Enclosure
Weight	18lbs. per case
UOM	10 per case

RNI-3900 Single Door Plastic Demarcation Enclosure



Features & Benefits

- Dual locking system
- Removable cover
- Plywood Optional
- UV stabilized plastic can be painted with Latex paint
- Countersunk mounting holes for easy mounting on uneven surfaces like aluminum or vinyl siding
- Standard color is Gray
- Custom Logos/Imprints
- Injection molded available

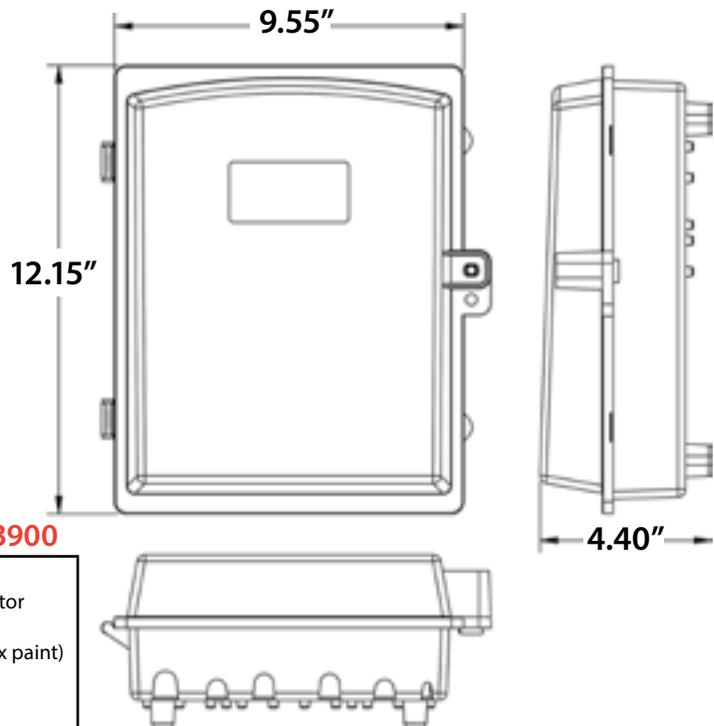

INDOOR/OUTDOOR WALL ENCLOSURE - RNI-3900

Stock ID	10-9899
Description	Plastic demarcation enclosure with locking terminator
Dimensions	12.15" H x 9.55" W x 4.40" D
Material	UV Stabilized Plastic, Gray (can be painted with latex paint)
Cable Entry	Multiple Entry Points at Bottom of Enclosure
Weight	18lbs per case
UOM	10 per case

RNI-3800 Single Door Plastic Demarcation Enclosure

Louvers are designed into cover to look like vents on the side of homes

Custom logo available and molded into plastic

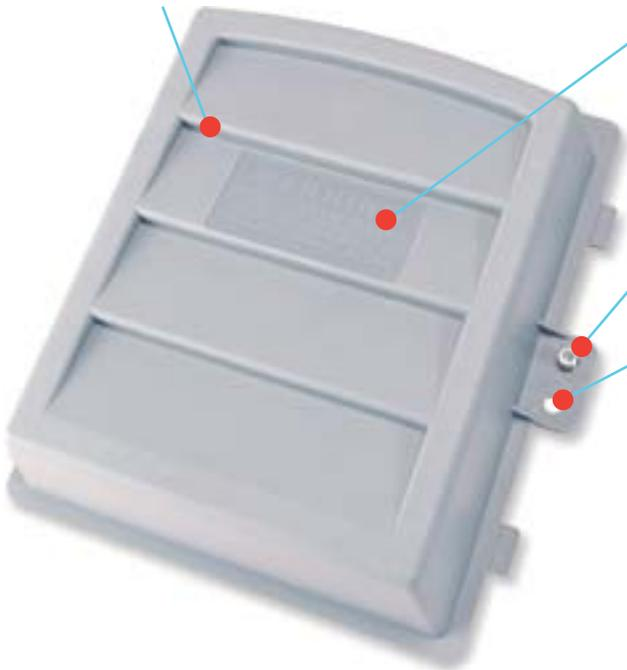

Locking Terminator
Locking hole for cable lock or wires

Features & Benefits

- Dual locking system
- Removable cover
- Plywood Optional
- UV stabilized plastic can be painted with Latex paint
- Countersunk mounting holes for easy mounting on uneven surfaces like aluminum or vinyl siding
- Standard color is Gray
- Custom Logos/Imprints. Injection molded available

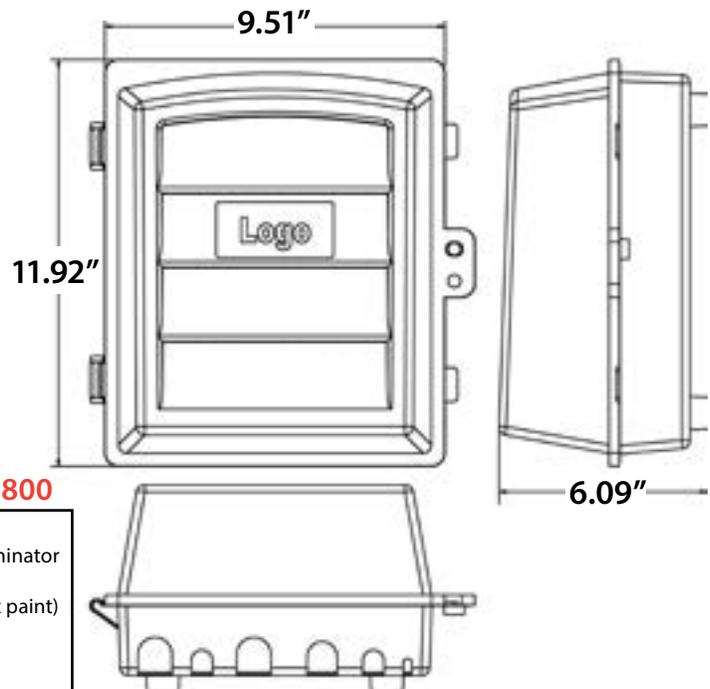

INDOOR/OUTDOOR WALL ENCLOSURE - RNI-3800

Stock ID	10-8609
Description	Single Door Demarkation Enclosure w/ Locking Terminator
Dimensions	11.92" H x 9.51" W x 6.09" D
Material	UV Stabilized Plastic, Gray (can be painted with latex paint)
Cable Entry	Multiple Entry Points at Bottom of Enclosure
Weight	18lbs. per case
UOM	10 per case

RNI-3615 Double Door Plastic Demarcation Enclosure



Punch Down Block Shown
Not Available

Features & Benefits

- Dual door access and locking
- Removable cover
- Countersunk mounting holes for easy mounting on uneven surfaces like aluminum or vinyl siding
- Custom injected molded logo available
- Weatherized UV stabilized plastic for the ultimate protection against the elements
- Enclosure can be painted with Latex paint
- Unique ribbed backing built into the enclosure for easy mounting of equipment anywhere on the pattern
- Removable plastic divider for increased versatility
- Plywood optional.
- Special resistance material available upon request, includes 15 year pro-rated warranty
- Standard color is gray

INDOOR/OUTDOOR WALL ENCLOSURE - RNI-3615

Stock ID	30632K
Description	Dual Door Demarkation Enclosure w/ Locking Terminator
Dimensions	13.84" H x 8" W x 4.43" D
Material	UV Stabilized Plastic, Gray (can be painted with latex paint)
Cable Entry	Multiple Entry Points at Bottom of Enclosure
UOM	10 per case

Minimum order 200pcs.

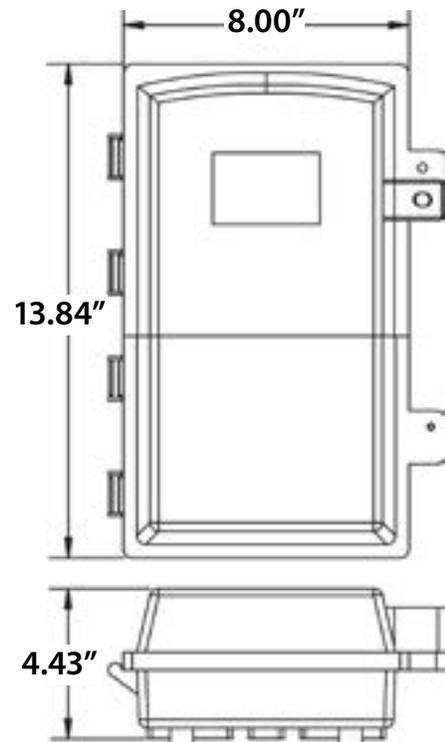

Multimedia Double Door Plastic Demarcation Enclosure

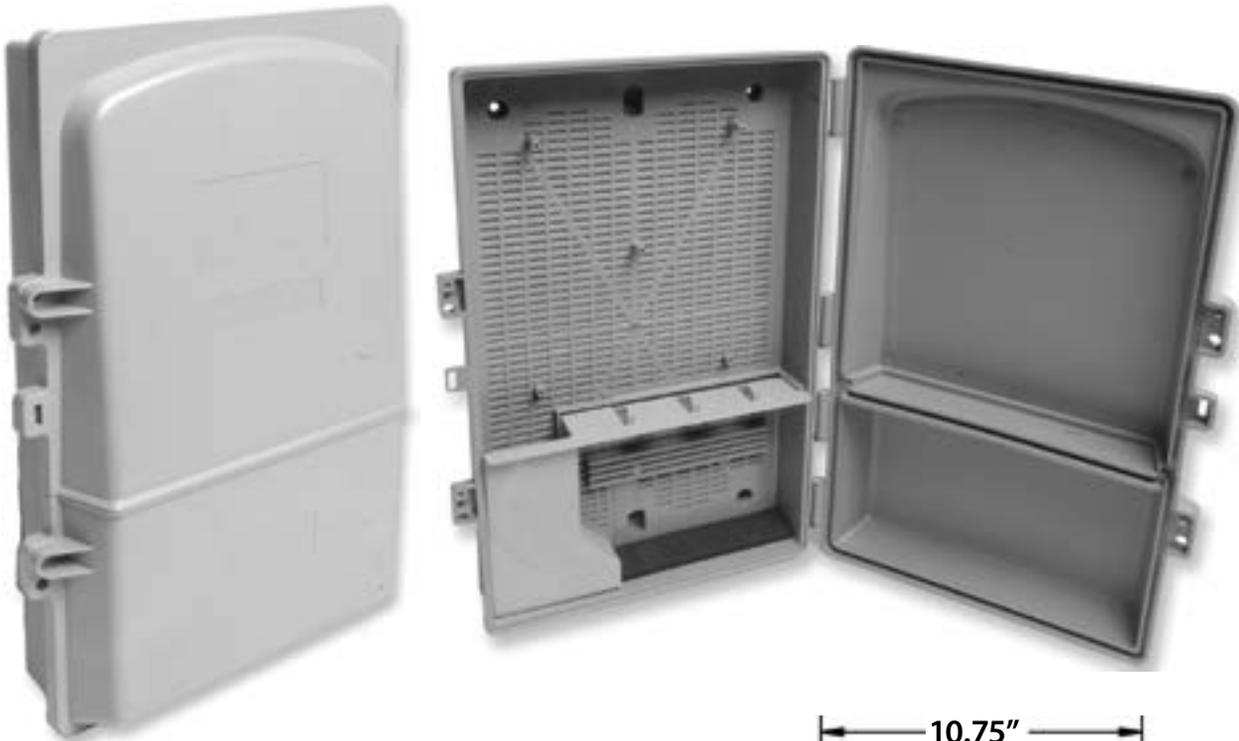

Exterior Features

- Weatherized UV stabilized plastic for the ultimate protection against the elements
- Dual locking system
- UV stabilized plastic can be painted with Latex paint
- Countersunk mounting holes for easy mounting on uneven surfaces like aluminum or vinyl siding
- Can be wall mounted or on a pedestal stake
- Standard color is Gray
- Custom Logos/Imprints. Injection molded available

Interior Features

- Both plastic dividers can be removed for increased versatility
- The removable plastic insert plate has 2 knockouts for F-81 hex holes and an open end hex hole in the center of plate for an F-81

INDOOR/OUTDOOR WALL ENCLOSURE - RNI-3620

Stock ID	30652K
Description	Dual Door Demarkation Enclosure w/ Locking Terminator
Dimensions	16.84" H x 10.75" W x 4.19" D
Material	UV Stabilized Plastic, Gray (can be painted with latex paint)
Cable Entry	Multiple Entry Points at Bottom of Enclosure
Weight	35 lbs. per case
UOM	10 per case

Minimum order 200pcs.

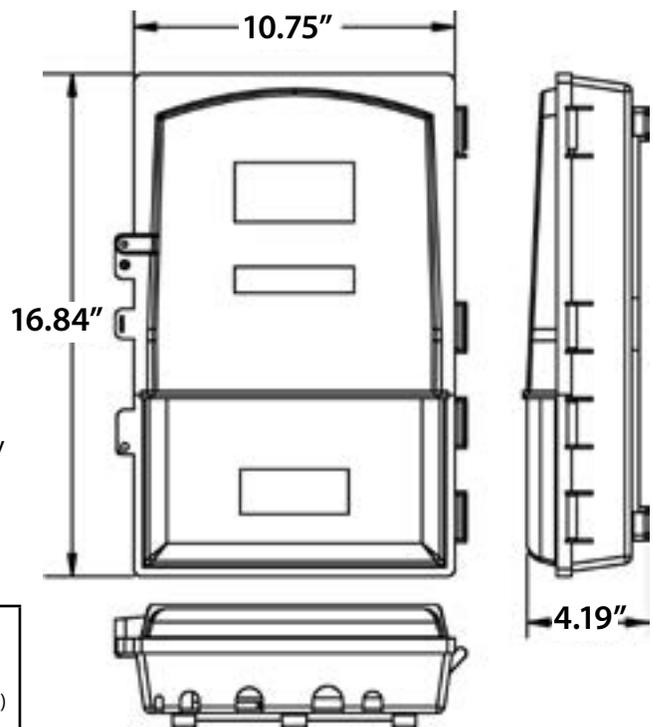

AM Series JIC Size Junction Box

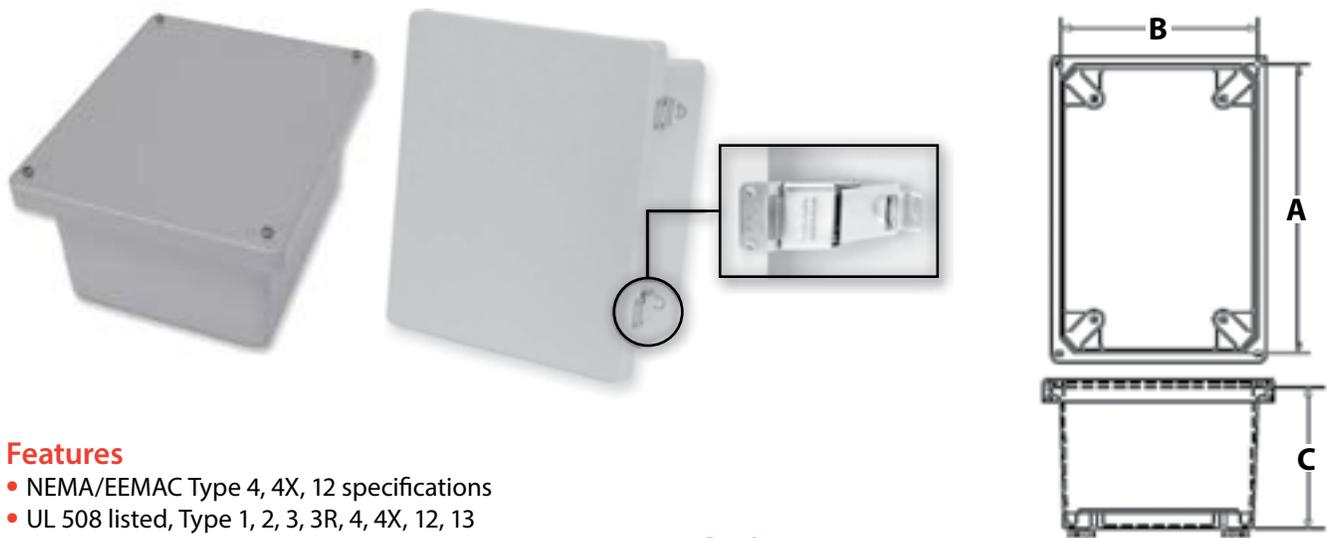

Features

- NEMA/EEMAC Type 4, 4X, 12 specifications
- UL 508 listed, Type 1, 2, 3, 3R, 4, 4X, 12, 13
- CSA certified LR 89590 for use with industrial equipment CSA Enc. 1, 2, 3, 4, 4X, 12, 13
- Strong, molded fiberglass reinforced polyester construction with matching flat cover
- Gasket made of closed cell neoprene cord encased in a continuous channel
- 304 stainless steel wall mounting feet with 10-32 stainless steel screws included
- 10-32 thread inserts are installed for optional back panel
- Fiberglass material is easily punched, drilled or sawed
- UV stabilized for outdoor use

Options

- Optional painted carbon steel back panels
- Optional aluminum back panels
- Custom size polycarbonate viewing windows
- Hinge installed on short side
- Molded-in color matches
- EMI/RFI shielding
- Factory supplied silk screening

Part#	Description	Dimensions	UOM
10-9001	AM 664 SERIES JIC Size Junction Boxes With Lift Off Screw Cover	6.1" A x 6.1" B x 4.18" C	Each
10-9002	AM 864 SERIES JIC Size Junction Boxes With Lift Off Screw Cover	8" A x 6.12" B x 4.13" C	Each
10-9003	AM 1084 SERIES JIC Size Junction Boxes With Lift Off Screw Cover	10.13" A x 8.26" B x 6.13" C	Each
10-9004	AM 1086 SERIES JIC Size Junction Boxes With Lift Off Screw Cover	10.13" A x 8.26" B x 6.13" C	Each
10-9005	AM 1206 SERIES JIC Size Junction Boxes With Lift Off Screw Cover	12.13" A x 10.26" B x 6.13" C	Each
10-9006	AM 1426 SERIES JIC Size Junction Boxes With Lift Off Screw Cover	14.13" A x 12.26" B x 6.13" C	Each
10-9007	AM 1648 SERIES JIC Size Junction Boxes With Lift Off Screw Cover	16.27" A x 14.4" B x 8.13" C	Each
10-9008	AM 1868 SERIES JIC Size Junction Boxes With Lift Off Screw Cover	18.4" A x 16.4" B x 8.13" C	Each
10-9009	AM 2068 SERIES JIC Size Junction Boxes With Lift Off Screw Cover	20" A x 16" B x 8.13" C	Each
10-9010	AM 664L SERIES JIC Size Junction Boxes With Hinged Cover	6.1" A x 6.1" B x 4.18" C	Each
10-9011	AM 864L SERIES JIC Size Junction Boxes With Hinged Cover	8" A x 6.12" B x 4.13" C	Each
10-9012	AM 1084L SERIES JIC Size Junction Boxes With Hinged Cover	10.13" A x 8.26" B x 4.13" C	Each
10-9013	AM 1086L SERIES JIC Size Junction Boxes With Hinged Cover	10.13" A x 8.26" B x 6.13" C	Each
10-9014	AM 1206L SERIES JIC Size Junction Boxes With Hinged Cover	12.13" A x 10.26" B x 6.13" C	Each
10-9015	AM 1426L SERIES JIC Size Junction Boxes With Hinged Cover	14.13" A x 12.26" B x 6.13" C	Each
10-9016	AM 1648L SERIES JIC Size Junction Boxes With Hinged Cover	16.27" A x 14.4" B x 8.13" C	Each
10-9017	AM 1868L SERIES JIC Size Junction Boxes With Hinged Cover	18.4" A x 16.4" B x 8.13" C	Each
10-9018	AM 2068L SERIES JIC Size Junction Boxes With Hinged Cover	20" A x 16" B x 8.13" C	Each

Splice Kits

Gelseal™ Splice Kit Re-Enterable



- One size fits all RG6/59 or RG7/11 drop cable and 2-6 twisted pair phones lines
- Reduces your inventory
- Stock one size for direct burial underground splices

Mechanical Specifications

Splices protected when direct buried and exposed to temperature ranges of -40°F to 140°F.

Test	Test Conditions
Environmental Cycling	-40°C to 60°C; 3 cycles/day; 100 cycles
Heat Aging	60°C; 30 days
Water Immersion	Room temperature for 30 days; 2 foot water head
Freeze-Thaw Cycling	-40°C to 60°C; 2 cycles per day; 1000 cycles
Salt Fog	Per ASTM B-368; 30 days
Soil Chemical Resistance	30 day immersion in: <ul style="list-style-type: none"> • 0.1N Na2SO4 • 0.1N H2SO4 • 0.1N NaCL • 0.1 NaOH
Fungus Resistance	Per ASTM G-21

Gelseal™ Re-Enterable



Gelseal™ Splice Kit Re-Enterable



3610-GS

Stock ID	34120K-OR 34120K-BLK
Description	For RG6/59 Drop Cable Twisted Pair Orange Kit
Dimensions	4" L x 1" W x 1.5" H
Weight	.10 lbs.
Material	Plastic with Silicone
UOM	Each



3611-GS

Stock ID	34122K-OR
Description	For RG7/11 Drop Cable Twisted Pair Orange Kit
Dimensions	7.75" L x 1.5" W x 1.75" H
Weight	-
Material	Plastic with Silicone
UOM	Each



3612-GS

Stock ID	34123K-OR
Description	Splice Repair Kit For 0.412 - 0.750 Feeder Cable Black Kit
Dimensions	12" L x 2.25" W x 3.5" D
Weight	-
Material	Plastic with Silicone
UOM	Each



Customer Favorite



3614-GS

Stock ID	34145K
Description	Multi Gelseal™ Splice Orange Kit
Dimensions	6" L x 2" W x 1" D
Weight	-
Material	Plastic with Silicone
UOM	Each



3616-GS

Stock ID	10-8342
Description	For RG59, RG6, RG7, RG11 and 312 Drop Cable Twisted Pair Black Kit
Dimensions	6" L x 2" W x 1" D
Weight	.21 lbs.
Material	Plastic with Silicone
UOM	Each

Splice Sealant



Features & Benefits

- Teflon filled thread sealing
- High temperature resistance
- Non-galling, non-seizing, and non-toxic
- Extreme resistance to rust and corrosion
- Non-corrosive to metals
- Non-staining
- Note: All above come with twist cap and squeezable bottle

F-Seal™

- Multilink's F-Seal was developed to maintain an internal seal against signal leakage from F-Connectors
- And no matter what brand of connector you are using, you must be able to seal the internal threads against the incursion of moisture, pollution, and other unpredictable weather conditions
- With a single drop of F-Seal on the thread port you will be able to maintain a more secure and a longer lasting seal than with silicone grease (Please note that the signal contact is made with the F-Connector post and not the threads)
- F-Seal is especially compounded to remain permanently elastic, even under extreme weather conditions
- F-Seal works effectively in temperatures ranging from -40°F to 400°F. Along with Multilink's Torque Wrench and a simple Weather Boot, you can ensure that you have the best seal possible at the absolute lowest cost
- F-Seal already has a proven track record that literally goes above and beyond the Cable TV industry standard
- F-Seal is derived from a compound that was used on the Space Shuttle to seal fittings, which proves that it can certainly meet any earthbound standard!

Stock ID	Description	Size	UOM
38260K	F-Seal Teflon Splice Sealant	4 Fl. Oz.	Each
38270K	F-Seal Teflon Splice Sealant	8 Fl. Oz.	Each

UDSP Splice Sealant



Stock ID	Description	Size	UOM
34402K	4421-GS Underground Drop Sealant	4.25" L x 2.375" W	Each
34401K	4425-UDSP Underground Drop Sealant	4.25" L x 2.375" W	50/Bag

Smart Clips Surface Mount/Siding Clips / The All-In-One Cable Clip!

- The Smart Clip replaces all the surface mounting clips and siding clips you are now using for cable installation on the side of homes
- Cut inventory from 20 line items to 2 line items
- There are only two Smart Clips, a surface mount clip and a siding clip
- They use detachable or multi-detachable tie wraps, eliminating the need for multiple sizes of clips
- Smart Clips can be used horizontally or vertically

Features & Benefits

- Lower inventory types, only two part numbers to stock
- Complete assembly - includes fastening screw (for surface mount)
- Fits all standard coaxial and twisted pair drop cables
- Ready for cable installation with an included outdoor tie wrap
- Vertical or horizontal mount for siding applications

Special Features

- Run additional cable/phone lines without installing additional clips



US Patent 6,378,814B1

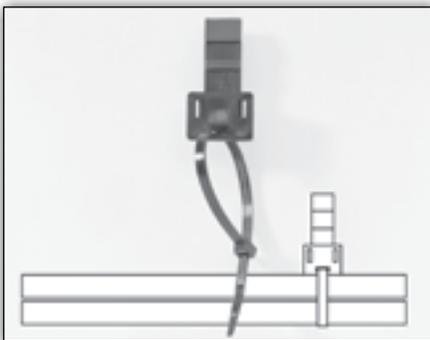

Siding Clip

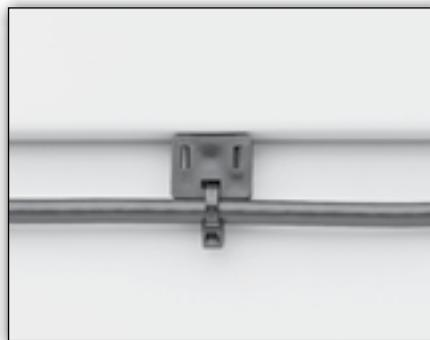

Horizontal Application



Vertical Application

Stock ID	Description	UOM
33626K	CHV-6W Siding Clip White	100/Case
33627K	CHV-6B Siding Clip Black	100/Case



Surface Mounting Clip



Add Twisted Pair

Stock ID	Description	UOM
33625K	CSM-6 Surface Mounting Clip Black	100/Case

Plastic Cable Clips Screw-In Clips for 6/59 or 7/11 Cable

Features & Benefits

- Clips secure to either 6/59 or 7/11 series cables without limiting transmission signal bandwidth
- UV stabilized Xenoy® clip body has a temperature range of -50°F to 300°F. No cracking, splitting, or chipping
- Smooth, rounded edges of clip bodies will not cut or abrade cable shielding, eliminating a cause of signal leakage
- Screws are specially hardened, plated, and treated to withstand 1,000 hours of corrosive salt spray testing per ASTM B 117

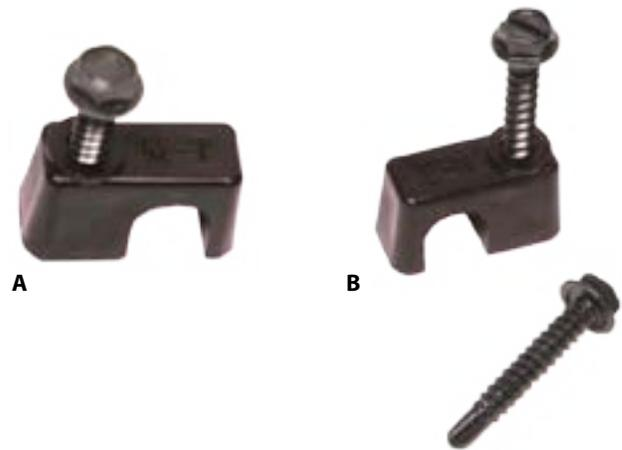

Figure	Part#	Description	Dimensions	UOM
A	10-9980	625-RG11 Plastic Strap & Screw For RG11	For 0.393" - 0.405" Diameter Cable	100/Bag
-	33535K	620-RG6QS Plastic Strap & Screw For RG6	For 0.272" - 0.300" Diameter Cable	100/Bag
B	33539K	625-RG6DS Plastic Strap With Drill & Tap Screw	For 0.272" - 0.300" Diameter Cable	100/Bag

DROP INSTALLATION MATERIALS

Plastic Horizontal and Vertical Siding Clips

Cable installers love this innovative design. Allows rapid, snap-on installation without special tools (only a screwdriver). No nails, no staples, no mess. These residential siding clips are trouble-free! The premium grade nylon lasts longer. Resists weather. Replacement call backs or complaints are virtually eliminated. The customers appreciate the safe and neat installation. No possible tool damage or punctures to siding. No rust or stain from nails or staples. No deterioration.

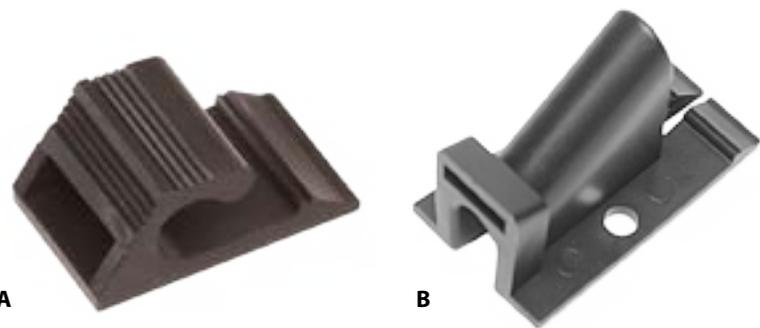

Figure	Part#	Description	UOM
A	10-6050	Horizontal Sliding Clip Black	100/Bag
B	10-6051	Vertical Sliding Clip Black	100/Bag

Drop Installation Materials



Squirrel Guard

- Protect hard and drop cable from hungry squirrels and other pesky rodents with Multilink Squirrel Guard
- Squirrel Guard is now available in two styles
- Both the Green Flex and the Squirrel Guard Slinky are easy to install and will provide superior protection from rodent damage to your cable

Part#	Description	Dimensions	UOM
24503	7003-SGJ (Slinky) For RG6 & RG59	-	100/Roll
24513	73435-SGT Green Flex	1.5" x 6'	75/Carton
24512	73435-SGT Green Flex	1.5" x 100'	100/Carton



Riser Tubing

Protect drop cable from weed eaters and environmental damage with solid wall riser tubing



Mounting Strap For Riser Tubing

Stock ID	Description	Dimensions	UOM
31701	Slit Back Snap-On Style Riser Tubing	.5" ID x .875" OD x 6'L	50/Case
31705	578-RT Solid Body Riser Tubing	.5" ID x .875" OD x 6'L	50/Case
31702	Mounting Strap for Riser Tubing	0.875"	Each

Multilink's Family Of Raceway



Downspout Exterior Raceway System



Featured Product

MULTIPLE APPLICATIONS

- Fiber
- CATV
- HVAC
- Teleco
- Coaxial
- Satellite
- Twisted Pair
- Solar



Patent No. US 7,964,804 B2

Downspout Exterior Raceway System

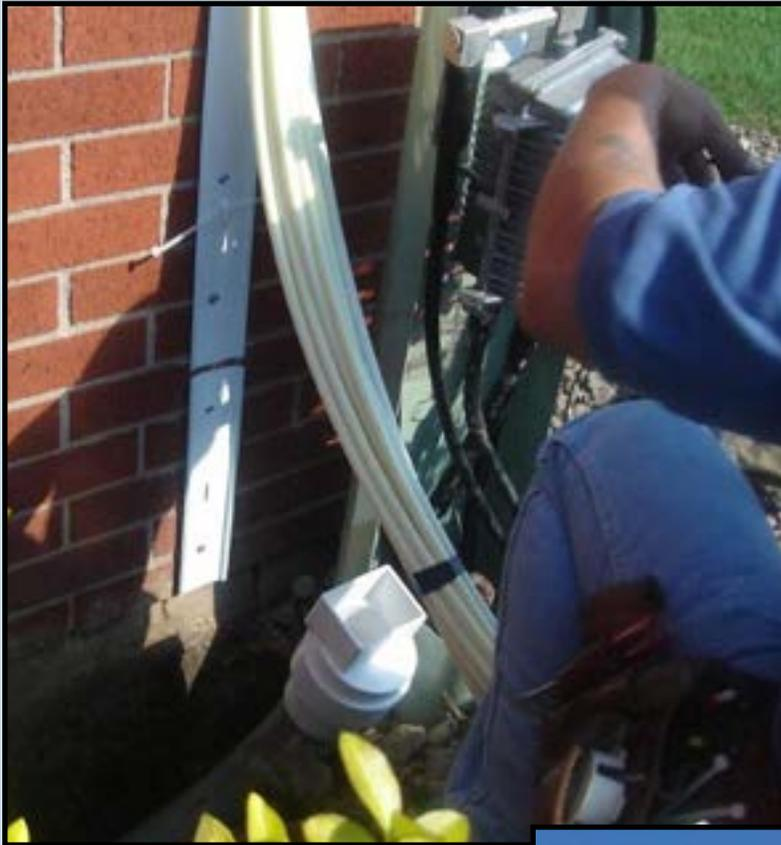

The patented Downspout Raceway System from Multilink provides a simple solution to cover up any wiring or piping that runs along your exterior walls. This system gives you the added benefits of maintaining the accepted architecture look that will be readily accepted by the end user as well as a quick and easy installation in the field.

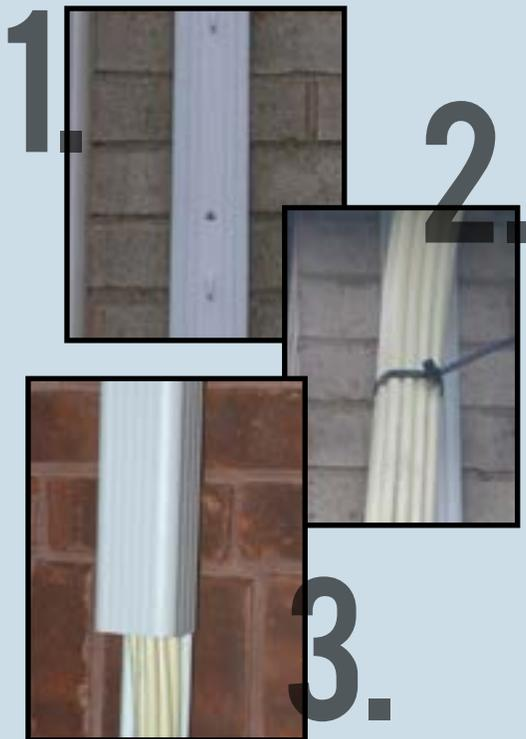

Downspout Exterior Raceway System

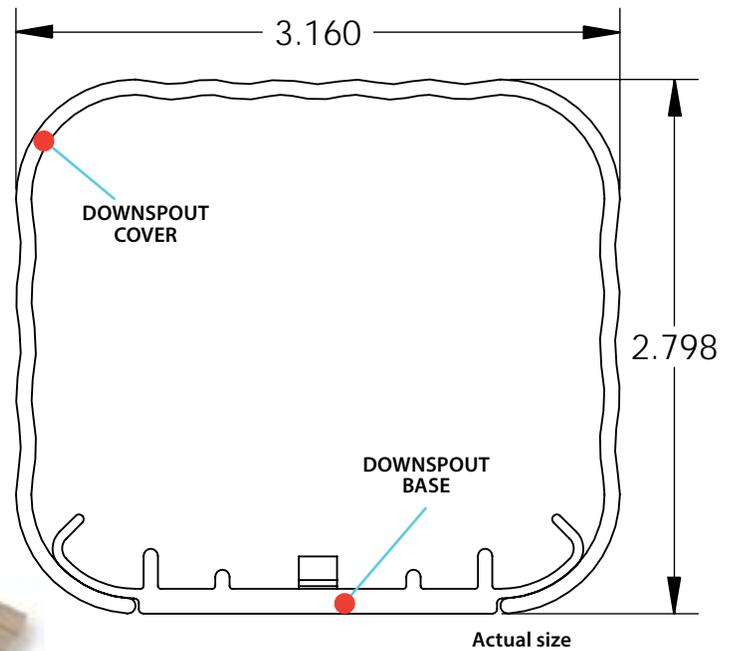
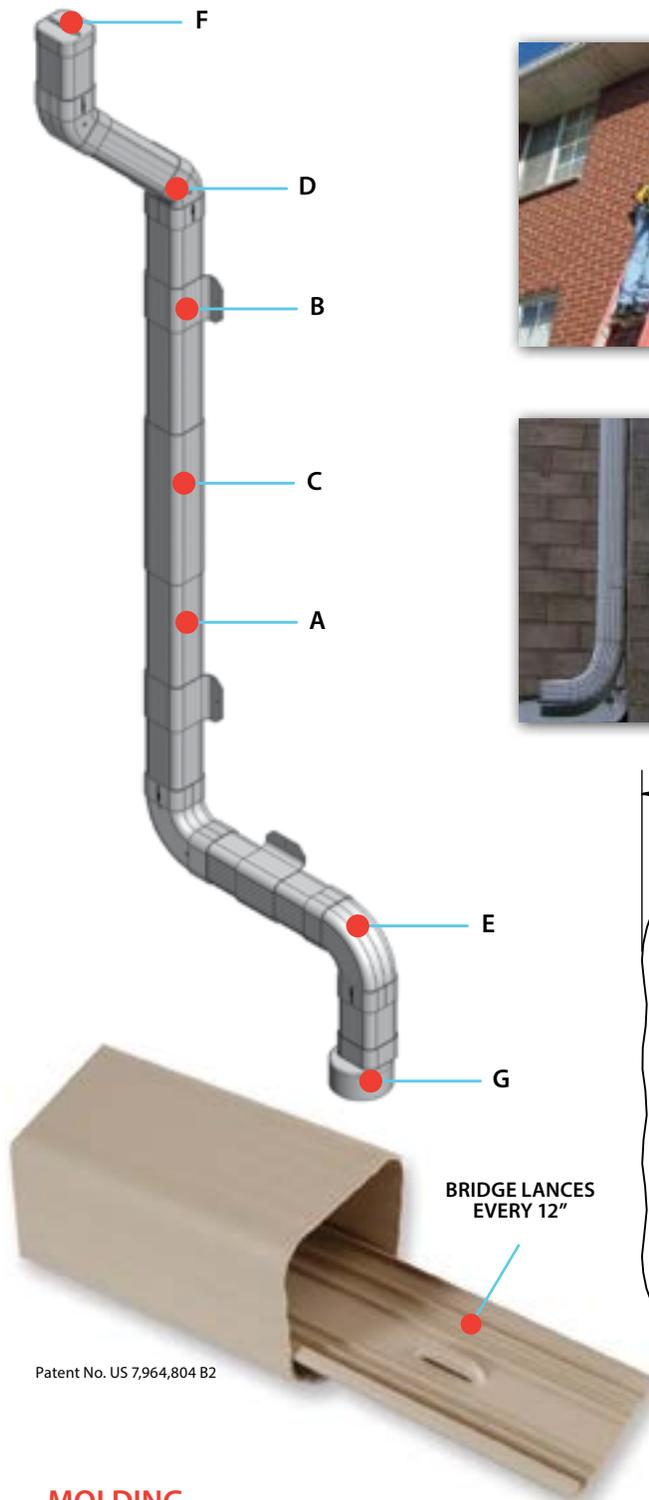

Patent No. US 7,964,804 B2

MOLDING

Item	Part #	Description	UOM
A	039-138-10	Downspout Molding White Plastic Exterior 8' (2 Piece System, Cover & Base)	96'/Ctn
A	039-138-11	Downspout Molding Brown Plastic Exterior 8' (2 Piece System, Cover & Base)	96'/Ctn
A	039-138-12	Downspout Molding Beige Plastic Exterior 8' (2 Piece System, Cover & Base)	96'/Ctn

Specifications subject to change without notice.

© Multilink, Inc. 2013 • All Rights Reserved

Downspout Exterior Raceway System

WALL STRAP



Item	Part #	Description	UOM
B	039-143-10	DWS-W Downspout Wall Strap White	10/Pack
B	039-143-11	DWS-B Downspout Wall Strap Brown	10/Pack
B	039-143-12	DWS-BE Downspout Wall Strap Beige	10/Pack

SEAM COVER



Item	Part #	Description	UOM
C	039-141-10	DSSC-W Downspout Seam Cover White	10/Pack
C	039-141-11	DSSC-B Downspout Seam Cover Brown	10/Pack
C	039-141-12	DSSC-BE Downspout Seam Cover Beige	10/Pack

45° FITTING (2 Piece System)



Item	Part #	Description	UOM
D	039-147-10	DSF-45-W Downspout 45 Degree Fitting White (2 Piece System)	Each
D	039-147-11	DSF-45-B Downspout 45 Degree Fitting Brown (2 Piece System)	Each
D	039-147-12	DSF-45-BE Downspout 45 Degree Fitting Beige (2 Piece System)	Each

90° FITTING (2 Piece System)



Item	Part #	Description	UOM
E	039-146-10	DSF-90-W Downspout 90 Degree Flat Fitting White (2 Piece System)	Each
E	039-146-11	DSF-90-B Downspout 90 Degree Flat Fitting Brown (2 Piece System)	Each
E	039-146-12	DSF-90-BE Downspout 90 Degree Flat Fitting Beige (2 Piece System)	Each

END CAP



Item	Part #	Description	UOM
F	039-139-10	DSEC-W Downspout End Cap Fitting White (1 Piece)	10/Pack
F	039-139-11	DSEC-B Downspout End Cap Fitting Brown (1 Piece)	10/Pack
F	039-139-12	DSEC-BE Downspout End Cap Fitting Beige (1 Piece)	10/Pack

ROUND ADAPTER



Item	Part #	Description	UOM
G	039-163-10	DSA-4R-W Downspout to 4" Round Adapter White	Each
G	039-164-10	DSA-3R-W Downspout to 3" Round Adapter White	Each

Architectural Latch Duct Raceway

Category 5, 5E and 6 1" Bend Radius Compliant - Available in our Standard Version



Architectural Latch Duct Raceway

Category 5, 5E and 6 1" Bend Radius Compliant - Available in our Standard Version

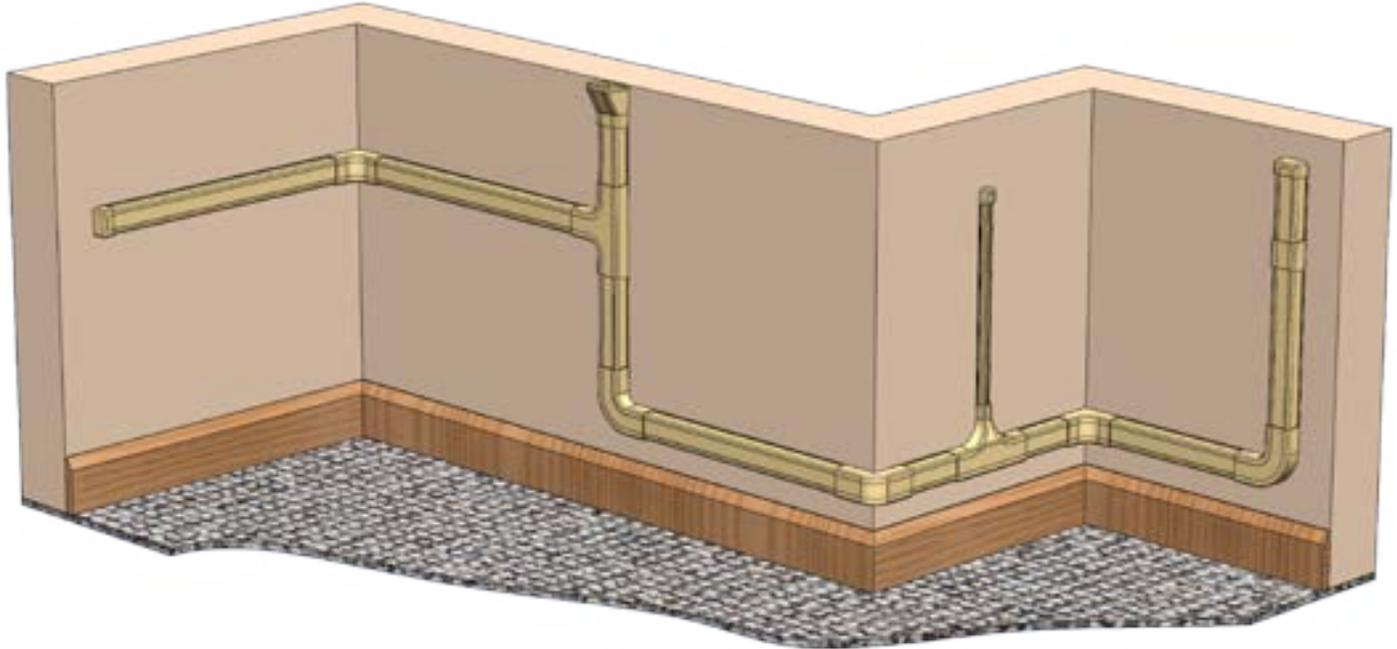

Features

- Fast Mounting One Piece Design
- Architectural MultiRaceway holds communication cables to a 1 inch bend radius, thus maintaining end to end connectivity even when filled to capacity or pulled through the raceway
- The one piece design constructed of 94V-O rigid vinyl features a highly flexible hinge and self-locking latch
- This can be easily accessed as many times as necessary without stress cracking or discoloration



UL Listed Material

Multilink Latch Duct MultiRaceway

Category 5, 5E and 6 1" Bend Radius Compliant



Features & Benefits

- The MRM Series Latch Duct Raceway is an adhesive backed, highly flexible, one piece design that installs quickly and easily
- All fittings incorporate a minimum of 1" bend radius, thus maintaining end to end connectivity even when filled to capacity or pulled through raceway.



Customer Favorite

A-C



A



B



C

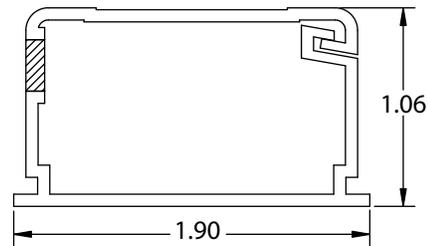
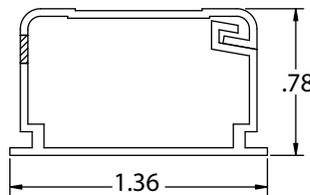
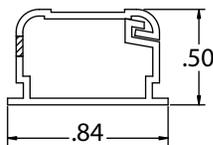

MOLDING

Figure	Stock ID	Part #	Description	Dimensions	Weight	UOM
A	99828	MRM75-I-T	Pre-Adhesive Backed Latch Duct Raceway	.84" W x .5" H x 6' L	9 Lbs./Ctn	120/Ctn
A	99825	MRM75-W-T	Pre-Adhesive Backed Latch Duct Raceway	.84" W x .5" H x 6' L	9 Lbs./Ctn	120/Ctn
A	99830	MRM75-OW-T	Pre-Adhesive Backed Latch Duct Raceway	.84" W x .5" H x 6' L	9 Lbs./Ctn	120/Ctn
B	99838	MRM12-I-T	Pre-Adhesive Backed Latch Duct Raceway	1.36" W x .78" H x 6' L	23 Lbs./Ctn	120/Ctn
B	99835	MRM12-W-T	Pre-Adhesive Backed Latch Duct Raceway	1.36" W x .78" H x 6' L	23 Lbs./Ctn	120/Ctn
B	99831	MRM12-OW-T	Pre-Adhesive Backed Latch Duct Raceway	1.36" W x .78" H x 6' L	23 Lbs./Ctn	120/Ctn
C	99848	MRM17-I-T	Pre-Adhesive Backed Latch Duct Raceway	1.90" W x 1.06" H x 6' L	33 Lbs./Ctn	120/Ctn
C	99845	MRM17-W-T	Pre-Adhesive Backed Latch Duct Raceway	1.90" W x 1.06" H x 6' L	33 Lbs./Ctn	120/Ctn
C	99832	MRM17-OW-T	Pre-Adhesive Backed Latch Duct Raceway	1.90" W x 1.06" H x 6' L	33 Lbs./Ctn	120/Ctn

Packed 120 ft. per carton
 Standard colors are Ivory, White and Office White
 Replace XX with I, W or OW for color designation
 Custom colors available on molding for a minimum run of 3,000 FT (500 pieces for fittings)
 Call Customer Service for more information

MutiClear Surface Raceway

Category 5, 5E and 6 1" Bend Radius Compliant



Features & Benefits

- The MultiClear Raceway encompasses a flexible vinyl base to hold and secure cable
- The cover can be removed without disrupting the cabling
- This two piece design has a clear base and solid covers available in our standard raceway colors of Ivory, White, and Office White
- The line is compatible with the fittings on the following pages

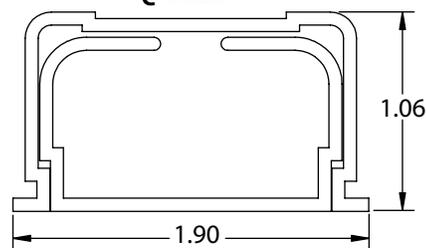
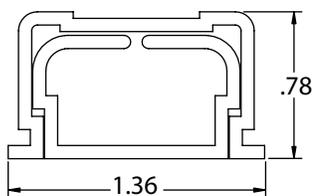
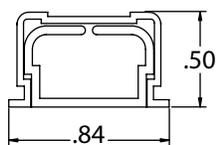

MOLDING

Figure	Stock ID	Part#	Description	Dimensions	Weight	UOM
A	99854	MRC75-I-T	Pre-Adhesive Multiclear Surface Raceway	.84" W x .5" H x 6' L	9 Lbs./Ctn	120'/Ctn
A	99855	MRC75-W-T	Pre-Adhesive Multiclear Surface Raceway	.84" W x .5" H x 6' L	9 Lbs./Ctn	120'/Ctn
A	039-549-10	MRC75-OW-T	Pre-Adhesive Multiclear Surface Raceway	.84" W x .5" H x 6' L	9 Lbs./Ctn	120'/Ctn
B	99860	MRC12-I-T	Pre-Adhesive Multiclear Surface Raceway	1.36" W x .78" H x 6' L	23 Lbs./Ctn	120'/Ctn
B	99861	MRC12-W-T	Pre-Adhesive Multiclear Surface Raceway	1.36" W x .78" H x 6' L	23 Lbs./Ctn	120'/Ctn
B	039-595-10	MRC12-OW-T	Pre-Adhesive Multiclear Surface Raceway	1.36" W x .78" H x 6' L	23 Lbs./Ctn	120'/Ctn
C	99866	MRC17-I-T	Pre-Adhesive Multiclear Surface Raceway	1.90" W x 1.06" H x 6' L	33 Lbs./Ctn	120'/Ctn
C	99867	MRC17-W-T	Pre-Adhesive Multiclear Surface Raceway	1.90" W x 1.06" H x 6' L	33 Lbs./Ctn	120'/Ctn
C	99869	MRC17-OW-T	Pre-Adhesive Multiclear Surface Raceway	1.90" W x 1.06" H x 6' L	33 Lbs./Ctn	120'/Ctn

Packed 120 ft. per carton
 Standard colors are Ivory, White and Office White
 Replace XX with I, W or OW for color designation
 Custom colors available on molding for a minimum run of 3,000 FT (500 pieces for fittings)
 Call Customer Service for more information

Fittings for MRM & MRC Series Molding

Category 5, 5E and 6 1" Bend Radius Compliant



Not Sold Separately

T-FITTING

Stock ID	Part #	Size	Color	UOM
99615K	MRF75-TRT-I	.75	Ivory	10/Pack
99616K	MRF75-TRT-W	.75	White	10/Pack
99614K	MRF75-TRT-OW	.75	Office White	10/Pack
99620K	MRF12-TRT-I	1.25	Ivory	10/Pack
99621K	MRF12-TRT-W	1.25	White	10/Pack
99623K	MRF12-TRT-OW	1.25	Office White	10/Pack
99625K	MRF17-TRT-I	1.75	Ivory	10/Pack
99626K	MRF17-TRT-W	1.75	White	10/Pack
99624K	MRF17-TRT-OW	1.75	Office White	10/Pack



Not Sold Separately

INSIDE CORNER

Stock ID	Part #	Size	Color	UOM
99459K	MRF75-ICR-I	.75	Ivory	10/Pack
99454K	MRF75-ICR-W	.75	White	10/Pack
99455K	MRF75-ICR-OW	.75	Office White	10/Pack
99463K	MRF12-ICR-I	1.25	Ivory	10/Pack
99465K	MRF12-ICR-W	1.25	White	10/Pack
99460K	MRF12-ICR-OW	1.25	Office White	10/Pack
99469K	MRF17-ICR-I	1.75	Ivory	10/Pack
99470K	MRF17-ICR-W	1.75	White	10/Pack
99475K	MRF17-ICR-OW	1.75	Office White	10/Pack



Not Sold Separately

OUTSIDE CORNER

Stock ID	Part #	Size	Color	UOM
99441K	MRF75-OCR-I Flat	.75	Ivory	10/Pack
99442K	MRF75-OCR-W Flat	.75	White	10/Pack
99443K	MRF75-OCR-OW Flat	.75	Office White	10/Pack



Not Sold Separately

99446K	MRF12-OCR-I Flat	1.25	Ivory	10/Pack
99447K	MRF12-OCR-W Flat	1.25	White	10/Pack
99445K	MRF12-OCR-OW Flat	1.25	Office White	10/Pack
99451K	MRF17-OCR-I Flat	1.75	Ivory	10/Pack
99452K	MRF17-OCR-W Flat	1.75	White	10/Pack
99450K	MRF17-OCR-OW Flat	1.75	Office White	10/Pack

Fittings for MRM & MRC Series Molding

Category 5, 5E and 6 1" Bend Radius Compliant



END CAP

Stock ID	Part #	Size	Color	UOM
99645K	MRF75-EC-I	.75	Ivory	10/Pack
99646K	MRF75-EC-W	.75	White	10/Pack
99647K	MRF75-EC-OW	.75	Office White	10/Pack
99651K	MRF12-EC-I	1.25	Ivory	10/Pack
99652K	MRF12-EC-W	1.25	White	10/Pack
99653K	MRF12-EC-OW	1.25	Office White	10/Pack
99656K	MRF17-EC-I	1.75	Ivory	10/Pack
99657K	MRF17-EC-W	1.75	White	10/Pack
99658K	MRF17-EC-OW	1.75	Office White	10/Pack



SEAM COVER

Stock ID	Part #	Size	Color	UOM
99411K	MRF75-JC-I	.75	Ivory	10/Pack
99412K	MRF75-JC-W	.75	White	10/Pack
99413K	MRF75-JC-OW	.75	Office White	10/Pack
99416K	MRF12-JC-I	1.25	Ivory	10/Pack
99417K	MRF12-JC-W	1.25	White	10/Pack
99418K	MRF12-JC-OW	1.25	Office White	10/Pack
99421K	MRF17-JC-I	1.75	Ivory	10/Pack
99422K	MRF17-JC-W	1.75	White	10/Pack
99423K	MRF17-JC-OW	1.75	Office White	10/Pack



Not Sold Separately

FLAT ELBOW

Stock ID	Part #	Size	Color	UOM
99486K	MRF75-FER-I	.75	Ivory	10/Pack
99487K	MRF75-FER-W	.75	White	10/Pack
99485K	MRF75-FER-OW	.75	Office White	10/Pack
99491K	MRF12-FER-I	1.25	Ivory	10/Pack
99492K	MRF12-FER-W	1.25	White	10/Pack
99490K	MRF12-FER-OW	1.25	Office White	10/Pack
99496K	MRF17-FER-I	1.75	Ivory	10/Pack
99497K	MRF17-FER-W	1.75	White	10/Pack
99495K	MRF17-FER-OW	1.75	Office White	10/Pack



REDUCER FITTING

Stock ID	Part #	Size	Color	UOM
99630K	MRF12-R75-IV	1.25 to .75	Ivory	10/Pack
99631K	MRF12-R75-W	1.25 to .75	White	10/Pack
99632K	MRF12-R75-OW	1.25 to .75	Office White	10/Pack
99635K	MRF17-R75-I	1.75 to .75	Ivory	10/Pack
99636K	MRF17-R75-W	1.75 to .75	White	10/Pack
99637K	MRF17-R75-OW	1.75 to .75	Office White	10/Pack

Fittings for MRM & MRC Series Molding

Category 5, 5E and 6 1" Bend Radius Compliant



Not Sold Separately

CEILING ENTRY

Stock ID	Part #	Size	Color	UOM
99319K	MRF75-CE-I	.75	Ivory	10/Pack
99321K	MRF75-CE-W	.75	White	10/Pack
99322K	MRF75-CE-OW	.75	Office White	10/Pack
99320K	MRF12-CE-I	1.25	Ivory	10/Pack
99323K	MRF12-CE-W	1.25	White	10/Pack
99324K	MRF12-CE-OW	1.25	Office White	10/Pack
99330K	MRF17-CE-I	1.75	Ivory	10/Pack
99331K	MRF17-CE-W	1.75	White	10/Pack
99332K	MRF17-CE-OW	1.75	Office White	10/Pack



TRANSITION FITTING

Stock ID	Part #	Size	Color	UOM
649-052-21	MRF12-TF-I	1.25	Ivory	10/Pack
649-052-23	MRF12-TF-W	1.25	White	10/Pack
649-052-22	MRF12-TF-OW	1.25	Office White	10/Pack
649-051-21	MRF17-TF-I	1.75	Ivory	10/Pack
649-051-23	MRF17-TF-W	1.75	White	10/Pack
649-051-22	MRF17-TF-OW	1.75	Office White	10/Pack



SLACK BOX ENTRY FITTING

Stock ID	Part #	Size	Color	UOM
039-305-20	MRF12-SBE-I	1.25	Ivory	10/Pack
039-284-20	MRF12-SBE-W	1.25	White	10/Pack
039-304-20	MRF12-SBE-LW	1.25	Office White	10/Pack
039-307-20	MRF17-SBE-I	1.75	Ivory	10/Pack
039-285-20	MRF17-SBE-W	1.75	White	10/Pack
039-306-20	MRF17-SBE-LW	1.75	Office White	10/Pack

Features & Benefits

- Used To Store Fiber Optic Cable
- Bend Radius Protection Spools
- Covers Have Knockouts For MRM, MRC And Single Fiber Raceway



MRS-3TB

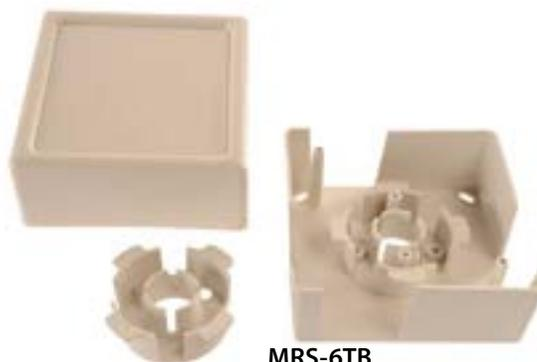

MRS-6TB

Stock ID	Description	Dimensions	Color	UOM
10-9433	MRS-3TB-LW Slack Storage Box w/Knockouts	3.95" x 3.95" x 1.19"	Linen White	Each
10-9434	MRS-3TB-IV Slack Storage Box w/Knockouts	3.95" x 3.95" x 1.19"	Ivory	Each
020-026-10	MRS-6TB-LW Slack Storage Box w/Knockouts	5.00" x 5.00" x 2.00"	Linen White	Each
020-026-11	MRS-6TB-IV Slack Storage Box w/Knockouts	5.00" x 5.00" x 2.00"	Ivory	Each

Multilink Raceway Cross Reference Chart

Category 5, 5E and 6 1" Bend Radius Compliant

Multilink	Description	Panduit Part#	Wiremold Part#	Tyton Part#	Dek Part#
MRM17	1.75" Raceway 6' L	LD10	2900	TSR3-6A	042-LD00
MRF17-JC	1.75" Seam or Joint Cover	CF10	2906	TSR3-14	042-0015
MRF17-TRT (includes base & cover)	1.75" Tee Fitting	TFC10	2915	TSR3-21-1	042-0021
MRF17-FER (includes base & cover)	1.75" Elbow Fitting	RAFC10	2911	TSR3-25-1	042-0025
MRF17-OCR (includes base & cover)	1.75" Outside Corner	OCFX10	2918	TSR3-29-1	042-0029
MRF17-ICR (includes base & cover)	1.75" Inside Corner	ICFC10	2917	TSR3-33-1	042-0033
MRF17-EC	1.75" End Cap	ECF10	2910B	TSR3-36	042-0036
MRF17-R7	1.75" - 1.25" Reducer	RF10X5	2989A	TSR1-12	042-0036H
MRF17-CE	1.75" Ceiling Drop	DCF10	2986	TSR3-50	042-0050

MRM12	1.25" Raceway 6' L	LD5	2800	TSR2-6A	N/A
MRF12-JC	1.25" Seam or Joint Cover	CF5	2806	TSR2-14	N/A
MRF12-TRT (includes base & cover)	1.25" Tee Fitting	TFC5	2815	TSR2-21-1	N/A
MRF12-FER (includes base & cover)	1.25" Elbow Fitting	RAFC5	2811	TSR2-25-1	N/A
MRF12-OCR (includes base & cover)	1.25" Outside Corner	OCFX5	2818	TSR2-29-1	N/A
MRF12-ICR (includes base & cover)	1.25" Inside Corner	ICFC5	2817	TSR2-33-1	N/A
MRF12-EC	1.25" End Cap	ECF5	2810B	TSR2-36	N/A
MRF12-R7	1.75" - .75" Reducer	RF10X3	2879A	TSR2-12	N/A
MRF12-CE	1.25" Ceiling Drop	DCF10	2886	TSR3-50	N/A

MRM75	.75" Raceway 6' L	LD3	2700	TSR1-6A	043-LD00
MRF75-JC	.75" Seam or Joint Cover	CF3	2706	TSR1-14	043-0015
MRF75-TRT (includes base & cover)	.75" Tee Fitting	TFC3	2715	TSR1-21-1	043-0021
MRF75-FER (includes base & cover)	.75" Elbow Fitting	RAFC3	2711	TSR1-25-1	043-0025
MRF75-OCR (includes base & cover)	.75" Outside Corner	OCFX3	2718	TSR1-29-1	043-0029
MRF75-ICR (includes base & cover)	.75" Inside Corner	ICFC3	2717	TSR1-33-1	043-0033
MRF75-EC	.75" End Cap	ECF3	2710B	TSR1-36	043-0036
MRF75-R7	1.25" - 3/4" Reducer	RF5X3	-	TSR3-12	-
MRF75-CE	.75" Ceiling Drop	DCF13	2786	TSR1-50	043-0050

Power Raceway Systems					
MRM400 (includes base and cover)	4" Multichannel 8' L	T70B	5400TB	MCRX-B8	N/A
MRM400-C	Cover for 4" Raceway	T70C	54000C	MCRX-C	N/A
MRM400-D	Divider for 4" Raceway	T70D	N/A	MCRW-SD	N/A
MRF400-DB	Data Box for 4" Raceway	T70DB	CM-EPLA	MCRX-CDB	N/A
MRF400-PB	Power Box for 4" Raceway	T70HB	5450-T	MCRX-EDB	N/A
MRF400-FER	Flat Elbow for 4" Raceway	T70RA	5411FO	MCRX-FE	N/A
MRF400-ICR	Inside Corner 4" Raceway	T70IC	5417FO	MCRX-IE	N/A
MRF400-EC	End Cap for 4" Raceway	T70EC	5410	MCRX-EC	N/A
MRF400-OCR	Outside Corner 4" Raceway	T70OCR	5418FO	MCRX-EE	N/A
MRF400-TBT	Transition Box 4" Raceway	T70T	5415FO	MCRX-TF	N/A
MRF400-WR	Wire Retainer 4" Raceway	T70WR	5400TWC	MCRG-WR	N/A
MRF400-JC	Joint Cover 4" Raceway	T70BC	5406A	MCRX-BS	N/A
Not Needed	Base Splice Cover	T70CC	5406T	MCRX-CS	N/A

Call Customer Service if the style you are interested in is not listed

MRM Series Raceway Fill Chart

Wire Type	Size	Diameter	MRM 75		MRM12		MRM17	
			40%	MAX	40%	MAX	40%	MAX
Coax	RG6/U	0.27	1	2	4	8	9	16
	RG59/U	0.242	1	2	5	10	12	20
	RG62/U	0.242	1	2	5	10	12	20
	RG58/U	0.193	3	5	9	15	18	30
Twisted Pair	2 pr	0.14	5	10	17	30	35	60
	24 AWG	3 pr	0.15	4	8	15	25	31
Unshielded	4 pr 5E	0.217	2	4	7	12	14	25
	4 pr 6	0.24	1	2	5	10	12	20
	25 pr	0.41	0	1	2	4	4	7
	Fiber Optic	2 strand	0.175	3	6	11	18	23
FA Jacket	4 strand	0.185	3	5	10	16	20	32
OFNP	6 strand	0.21	2	4	7	12	15	25
Electrical	14 AWG	0.105		7		10		14
	12AWG	0.122		5		8		11
	10AWG	0.153		3		5		6

40% - Column follows the guidelines of EIA/TIA for cable fill allowing for additions after install

MAX - Marketing recommended maximum fill based on bend radius and internal cabling area

Note - UL material used in MRM series raceway manufacturing

Product not currently UL listed

Non-Metallic Architectural Flat Wave Hinged Molding

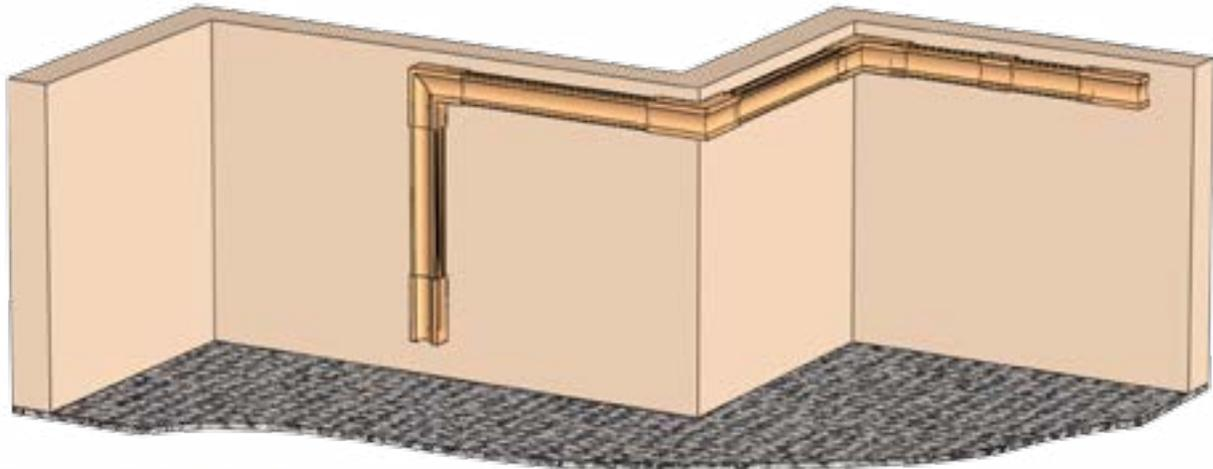

MOLDING

Stock ID	Part #	Description	Dimensions	UOM
21367	84180-HM-2-BE	Flat Wave Hinge Molding	2" x 1.25" x 8'	144' / Ctn
21366	84180-HM-2-WH	Flat Wave Hinge Molding	2" x 1.25" x 8'	144' / Ctn



INSIDE ELBOW

Stock ID	Part #	Description	Dimensions	UOM
26307	84186-IEHM-BE	Inside Elbow Fitting	2"	Each
26306	84186-IEHM-WH	Inside Elbow Fitting	2"	Each



OUTSIDE ELBOW

Stock ID	Part #	Description	Dimensions	UOM
26317	84187-OEHM-BE	Outside Elbow Fitting	2"	Each
26316	84187-OEHM-WH	Outside Elbow Fitting	2"	Each



END CAP

Stock ID	Part #	Description	Dimensions	UOM
26337	84183-ECH-BE	End Cap Fitting	2"	Each
26336	84183-ECH-WH	End Cap Fitting	2"	Each



FLAT ELBOW

Stock ID	Part #	Description	Dimensions	UOM
26327	84184-FEHM-BE	Flat Elbow Fitting	2"	Each
26326	84184-FEHM-WH	Flat Elbow Fitting	2"	Each

Standard Colors are Beige and White

Ultra High Security Locking Molding 2-Piece Lock Molding

3" bend radius meets coax drop cable return path bend radius standards



MOLDING

Stock ID	Part #	Description	Dimensions	UOM
27032	MRL10-EX	Lock Molding Top/Bottom Exterior Grade	.75" W x .8125" H x 8' L	360'/Ctn
27030	MRL20-EX	Lock Molding Top/Bottom Exterior Grade	2" W x .36" H x 8' L	160'/Ctn



INSIDE CORNER

Stock ID	Part #	Description	Dimensions	UOM
27097	MRF34-ICR-EX	Inside Corner Fitting	.75"	Each
27082	MRF25-IC-EX	Inside Corner Fitting	2"	Each



OUTSIDE CORNER

Stock ID	Part #	Description	Dimensions	UOM
27095K	MRF34-OCR-EX	Outside Corner Fitting (Cover and Base Included)	.75"	Each
27084	MRF25-OC-EX	Outside Corner Fitting	2"	Each
27085	MRF25-OR-EX	Outside Radius Fitting	2"	Each



FLAT ELBOW

Stock ID	Part #	Description	Dimensions	UOM
27099K	MRF34-FER-EX	Flat Elbow Fitting (Cover and Base Included)	.75"	Each
27080K	MRF25-FER-EX	Flat Elbow Fitting (Cover and Base Included)	2"	Each



SEAM COVER

Stock ID	Part #	Description	Dimensions	UOM
27091	MRF34-SC-EX	Seam Cover Fitting	.75"	Each
27087	MRF25-SC-EX	Seam Cover Fitting	2"	Each



END CAP

Stock ID	Part #	Description	Dimensions	UOM
27103	MRF34-EC-EX	End Cap Fitting	.75"	Each
27031	MRF25-EC-EX	End Cap Fitting	2"	Each



WALL ENTRY

Stock ID	Part #	Description	Dimensions	UOM
27092	MRF34-WE-EX	Wall Entry	.75"	Each
27093	MRF25-WE-EX	Wall Entry	2"	Each



T-FITTING

Stock ID	Part #	Description	Dimensions	UOM
27010	MRF34-T-EX	T-Fitting	.75"	Each
27011	MRF34-TR-EX	T-Radius Fitting	.75"	Each
27088	MRF25-T-EX	T-Fitting	2"	Each



REDUCER

Stock ID	Part #	Description	Dimensions	UOM
27086	MRF25-R3-EX	Reducer Fitting	2" to .75"	Each

Standard Color is Ivory

Flat Box Molding

Flat Box is a two piece molding with a snap-on cover that is easy to re-enter
The special V-shaped grooves in the cover allow for a tighter, more secure fit to the base

MOLDING



Stock ID	Part #	Description	Dimensions	Color	UOM
23217	84140-FBMH-BE	Flat Box Molding	2" W x .75" H x 8' L	Beige	192/Ctn
23216	84140-FBMH-WH	Flat Box Molding	2" W x .75" H x 8' L	White	192/Ctn
23237	84180-FBMH-BE	Flat Box Molding	2" W x 1.25" H x 8' L	Beige	144/Ctn
23235	84180-FBMH-WH	Flat Box Molding	2" W x 1.25" H x 8' L	White	144/Ctn
23267	84200-FBMH-BE	Flat Box Molding	2" W x 2" H x 8' L	Beige	64' / Ctn
23266	84200-FBMH-WH	Flat Box Molding	2" W x 2" H x 8' L	White	64' / Ctn
25974	84242-FBMH-BE	Flat Box Molding	2.125" W x 2.25" H x 8' L	Beige	64' / Ctn
25973	84242-FBMH-WH	Flat Box Molding	2.125" W x 2.25" H x 8' L	White	64' / Ctn

FLAT ELBOW



Stock ID	Part #	Description	Dimensions	Color	UOM
28217	84144-FE/FBM-BE	Flat Elbow	2" x .75"	Beige	Each
28220	84144-FE/FBM-WH	Flat Elbow	2" x .75"	White	Each
28249	84184-FE/FBM-BE	Flat Elbow	2" x 1.25"	Beige	Each
28245	84184-FE/FBM-WH	Flat Elbow	2" x 1.25"	White	Each
28277	84204-FE/FBM-BE	Flat Elbow	2" x 2"	Beige	Each
28279	84204-FE/FBM-WH	Flat Elbow	2" x 2"	White	Each

INSIDE ELBOW



Stock ID	Part #	Description	Dimensions	Color	UOM
28017	84146-IE/FBM-BE	Inside Elbow	2" x .75"	Beige	Each
28023	84146-IE/FBM-WH	Inside Elbow	2" x .75"	White	Each
28037	84186-IE/FBM-BE	Inside Elbow	2" x 1.25"	Beige	Each
28036	84186-IE/FBM-WH	Inside Elbow	2" x 1.25"	White	Each
28067	84206-IE/FBM-BE	Inside Elbow	2" x 2"	Beige	Each
28066	84206-IE/FBM-WH	Inside Elbow	2" x 2"	White	Each
039-408-10	84242-FBMH-IC-BE	Inside Elbow	2.125" x 2.25"	Beige	Each
10-6072	84242-FBMH-IC-WH	Inside Elbow	2.125" x 2.25"	White	Each

OUTSIDE ELBOW



Stock ID	Part #	Description	Dimensions	Color	UOM
28117	84147-OE/FBM-BE	Outside Elbow	2" x .75"	Beige	Each
28121	84147-OE/FBM-WH	Outside Elbow	2" x .75"	White	Each
28137	84187-OE/FBM-BE	Outside Elbow	2" x 1.25"	Beige	Each
28136	84187-OE/FBM-WH	Outside Elbow	2" x 1.25"	White	Each
28167	84207-OE/FBM-BE	Outside Elbow	2" x 2"	Beige	Each
28166	84207-OE/FBM-WH	Outside Elbow	2" x 2"	White	Each
039-409-10	84242-FBMH-OC-BE	Outside Elbow	2.125" x 2.25"	Beige	Each
10-6073	84242-FBMH-OC-WH	Outside Elbow	2.125" x 2.25"	White	Each

Self Adhesive Single Fiber Molding

3mm Fiber Only

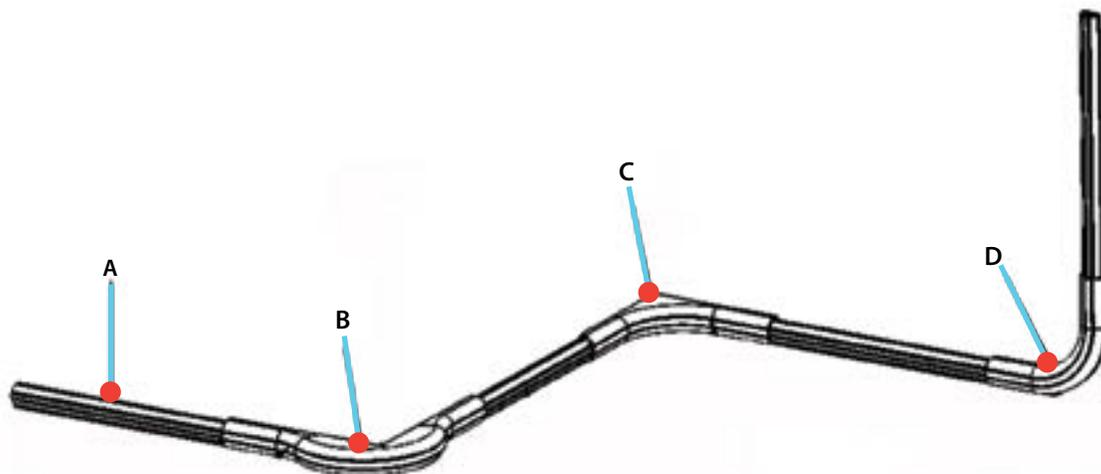

MOLDING

Stock ID	Part #	Description	Color	UOM
A 10-9405	FDM3AB-IV	Single Fiber Drop Molding	Ivory	600/Feet
A 10-9404	FDM3AB-LW	Single Fiber Drop Molding	Linen White	600/Feet



OUTSIDE CORNER

Stock ID	Part #	Description	Color	UOM
B 10-9409	FDF3-OCR-IV	OC & Radius for Single Fiber Drop Molding	Ivory	10/Pack
B 10-9408	FDF3-OCR-LW	OC & Radius for Single Fiber Drop Molding	Linen White	10/Pack

Not Sold Separately



INSIDE CORNER

Stock ID	Part #	Description	Color	UOM
C 10-9407	FDF3-ICR-IV	IC & Molded Radius Single Fiber Drop Molding	Ivory	10/Pack
C 10-9406	FDF3-ICR-LW	IC & Molded Radius Single Fiber Drop Molding	Linen White	10/Pack



FLAT ELBOW

Stock ID	Part #	Description	Color	UOM
D 10-9410	FDF3-FER-IV	Flat Elbow w/ Molded Radius Single Fiber Drop Molding	Ivory	10/Pack
D 10-9411	FDF3-FER-LW	Flat Elbow w/ Molded Radius Single Fiber Drop Molding	Linen White	10/Pack

Architectural Plastic Wave Molding

For Interior Use Only

6 different modular designs allow for greater flexibility in one raceway system
 Category 5, 5E and 6 1" Bend Radius Compliant

MOLDING



Lance Option Available

Stock ID	Part #	Description	Color	Dimensions	UOM
21096	84125-W	Wave Molding	White	2.5" W x 8' L	240'/Ctn
21097	84125-W	Wave Molding	Beige	2.5" W x 8' L	240'/Ctn
21196	84125-WH	Hinged Wave Molding	White	2.5" W x 8' L	160'/Ctn
21197	84125-WH	Hinged Wave Molding	Beige	2.5" W x 8' L	160'/Ctn
21299	84125-WH-AB	Hinged Wave Molding w/ Adhesive Backing	Beige	2.5" W x 8' L	160'/Ctn
21290	84130-W	Wave Molding	White	2.75" W x 8' L	160'/Ctn
21291	84130-W	Wave Molding	Beige	2.75" W x 8' L	160'/Ctn
039-131-10	84170-W	Wave Molding	White	3.5" W x 8' L	64'/Ctn
21320	84170-W	Wave Molding	Beige	3.5" W x 8' L	64'/Ctn
23208	84140-W	Wave Molding	White	4" W x 8' L	96'/Ctn
23209	84140-W	Wave Molding	Beige	4" W x 8' L	96'/Ctn

INSIDE ELBOW



Stock ID	Part #	Description	Color	Dimensions	UOM
26006	84125-IEW	Inside Elbow	White	2.5"	Each
26007	84125-IEW	Inside Elbow	Beige	2.5"	Each
039-132-10	84175-IEW	Inside Elbow	White	3.5"	Each
21325	84175-IEW	Inside Elbow	Beige	3.5"	Each
21295	84130-IEWL	Inside Elbow	White	2.75"	Each
21294	84130-IEWL	Inside Elbow	Beige	2.75"	Each

OUTSIDE ELBOW



Stock ID	Part #	Description	Color	Dimensions	UOM
26016	84125-OEW	Outside Elbow	White	2.5"	Each
26017	84125-OEW	Outside Elbow	Beige	2.5"	Each
039-133-10	84175-OEW	Outside Elbow	White	3.5"	Each
21330	84175-OEW	Outside Elbow	Beige	3.5"	Each
21293	84130-OEWL	Outside Elbow	White	2.75"	Each
21292	84130-OEWL	Outside Elbow	Beige	2.75"	Each

Architectural Plastic Wave Molding For Interior Use Only

6 different modular designs allow for greater flexibility in one raceway system
 Category 5, 5E and 6 1" Bend Radius Compliant

LEFT END CAP



Stock ID	Part #	Description	Color	Dimensions	UOM
039-477-10	84125-CW	Left End Cap	White	2.5"	Each
039-478-10	84125-CW	Left End Cap	Beige	2.5"	Each
039-461-10	84175-CW	Left End Cap	White	3.5"	Each
039-469-10	84175-CW	Left End Cap	Beige	3.5"	Each

RIGHT END CAP



Stock ID	Part #	Description	Color	Dimensions	UOM
26036	84125-CW	Right End Cap	White	2.5"	Each
26037	84125-CW	Right End Cap	Beige	2.5"	Each
039-134-10	84175-CW	Right End Cap	White	3.5"	Each
039-196-10	84175-CW	Right End Cap	Beige	3.5"	Each

T-FITTING



Stock ID	Part #	Description	Color	Dimensions	UOM
99687K	MCF27-T-W	T-Fitting	White	2.5"	10 / Pack
99686K	MCF27-T-BE	T-Fitting	Beige	2.5"	10 / Pack

Custom colors available on molding for a minimum run of 3,000 FT (500 pieces for fittings)
 Call Customer Service for more information

Cove Molding

Category 5, 5E and 6 1" Bend Radius Compliant



MOLDING

Stock ID	Part #	Description	Color	Dimensions	UOM
22678	84108-VM	Cove Molding	White	2.0625" x 8'	320'/Ctn
22677	84108-VM	Cove Molding	Beige	2.0625" x 8'	320'/Ctn
22696	84125-VM	Cove Molding	White	2.75" x 8'	240'/ Ctn
22697	84125-VM	Cove Molding	Beige	2.75" x 8'	240'/ Ctn
039-541-10	84125-VM	Cove Molding	Linen White	2.75" x 8'	240'/ Ctn

Lance Option Available

INSIDE ELBOW

Stock ID	Part #	Description	Color	Dimensions	UOM
28079	84106-IEVL	Inside Elbow	White	2.0625"	Each
28077	84106-IEVL	Inside Elbow	Beige	2.0625"	Each
28088	84125-IEVL	Inside Elbow	White	2.75"	Each
28087	84125-IEVL	Inside Elbow	Beige	2.75"	Each
039-542-10	84125-IEVL	Inside Elbow	Linen White	2.75"	Each



OUTSIDE ELBOW

Stock ID	Part #	Description	Color	Dimensions	UOM
28179	84107-OEVL	Outside Elbow	White	2.0625"	Each
28177	84107-OEVL	Outside Elbow	Beige	2.0625"	Each
28189	84125-OEVL	Outside Elbow	White	2.75"	Each
28187	84125-OEVL	Outside Elbow	Beige	2.75"	Each
039-543-10	84125-OEVL	Outside Elbow	Linen White	2.75"	Each



END CAP

Stock ID	Part #	Description	Color	Dimensions	UOM
28389	84108-CV	End Cap Left	White	2.0625" x 8"	Each
28388	84108-CV	End Cap Left	Beige	2.0625" x 8"	Each
039-463-10	84108-CV	End Cap Right	White	2.0625" x 8"	Each
039-462-10	84108-CV	End Cap Right	Beige	2.0625" x 8"	Each
28398	84125-CV	End Cap Left	White	2.75" x 8"	Each
28397	84125-CV	End Cap Left	Beige	2.75" x 8"	Each
039-544-10	84125-CV	End Cap Left	Linen White	2.75" x 8"	Each
039-473-10	84125-CV	End Cap Right	White	2.75" x 8"	Each
039-472-10	84125-CV	End Cap Right	Beige	2.75" x 8"	Each
039-545-10	84125-CV	End Cap Right	Linen White	2.75" x 8"	Each



2 PIECE FINGER DROP SPLICE

Stock ID	Part #	Description	Color	Dimensions	UOM
28295	84020-FDS-WH	2 Piece Finger Drop Splice	White	.5" x 8"	Each
28298	84020-FDS-BE	2 Piece Finger Drop Splice	Beige	.5" x 8"	Each



Custom colors available on molding for a minimum run of 3,000 FT (500 pieces for fittings)
Call Customer Service for more information

Overlay Molding

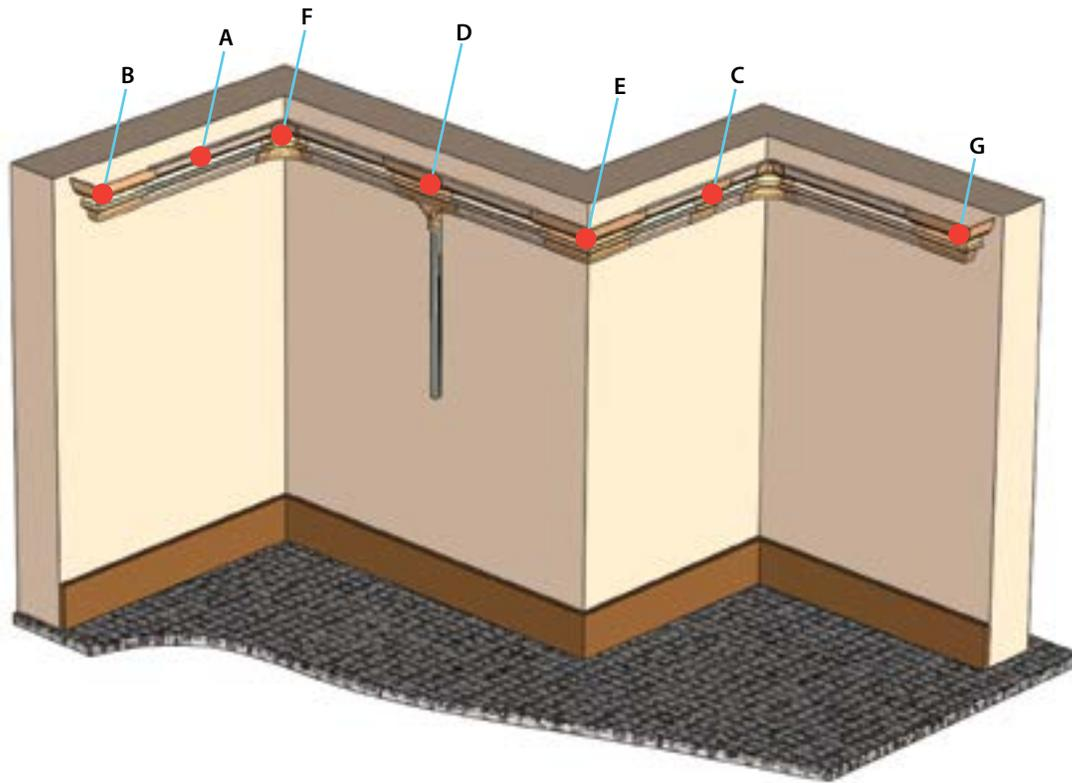

Overlay Molding™ was designed to be installed over an existing provider’s molding system. It is a two piece design, which allows for access to the first molding system without disconnecting any cables. The cover of the overlay simply snaps onto the base which is mounted below the existing molding and “covers up” the existing molding and the new base. The base of the Overlay Molding™ has a smooth co-extruded flexible cable keeper which won’t damage any cables during installation or removal. The corner pieces include bend radius protectors to maintain the minimum bend radius of 1”.

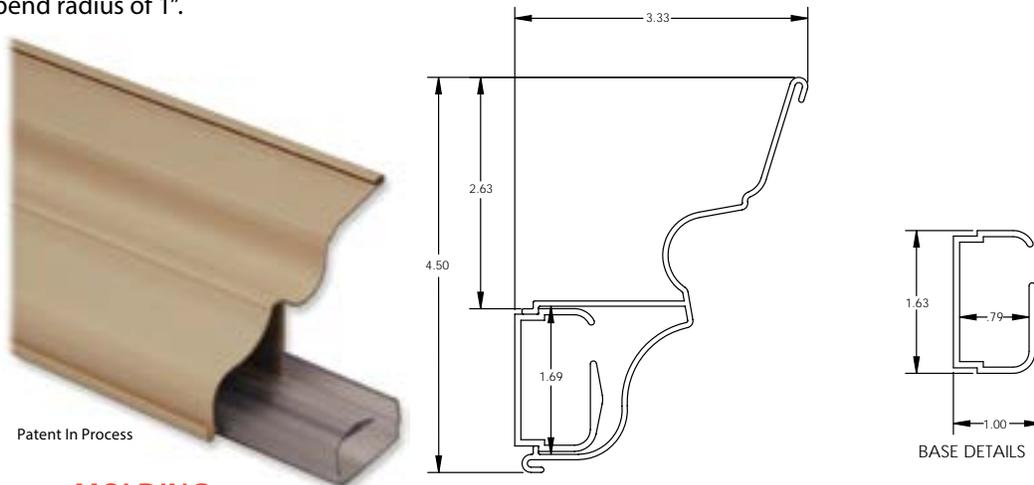

Patent In Process

MOLDING

Stock ID	Part #	Description	Color	UOM
A 10-9387	MRW-15-IV	Overlay Molding/Open Crown 1.5" x .75" for MDU	Ivory	80/Ctn
A 10-9386	MRW-15-LW	Overlay Molding/Open Crown 1.5" x .75" for MDU	Linen White	80/Ctn

Overlay Molding™



LEFT END CAP

Stock ID	Part #	Description	Color	UOM
B	10-9379	MRW15-EC-L-IV	Ivory	10/Pack
B	10-9378	MRW15-EC-L-LW	Linen White	10/Pack



SEAM COVER

Stock ID	Part #	Description	Color	UOM
C	10-9376	MRW15-SC-IV	Ivory	10/Pack
C	10-9375	MRW15-SC-LW	Linen White	10/Pack



COVER DROP "T"

Stock ID	Part #	Description	Color	UOM
D	10-9383	MRW15-DTRB-IV	Ivory	10/Pack
D	10-9382	MRW15-DTRB-LW	Linen White	10/Pack

Radius Not Sold Separately



OUTSIDE CORNER

Stock ID	Part #	Description	Color	UOM
E	10-9391	MRW15-OWCR-IV	Ivory	10/Pack
E	10-9390	MRW15-OWCR-LW	Linen White	10/Pack

Radius Not Sold Separately



INSIDE CORNER

Stock ID	Part #	Description	Color	UOM
F	10-9389	MRW15-IER-IV	Ivory	10/Pack
F	10-9388	MRW15-IER-LW	Linen White	10/Pack

Radius Not Sold Separately



RIGHT END CAP

Stock ID	Part #	Description	Color	UOM
G	10-9380	MRW15-EC-R-IV	Ivory	10/Pack
G	10-9381	MRW15-EC-R-LW	Linen White	10/Pack

Quarter Round Molding

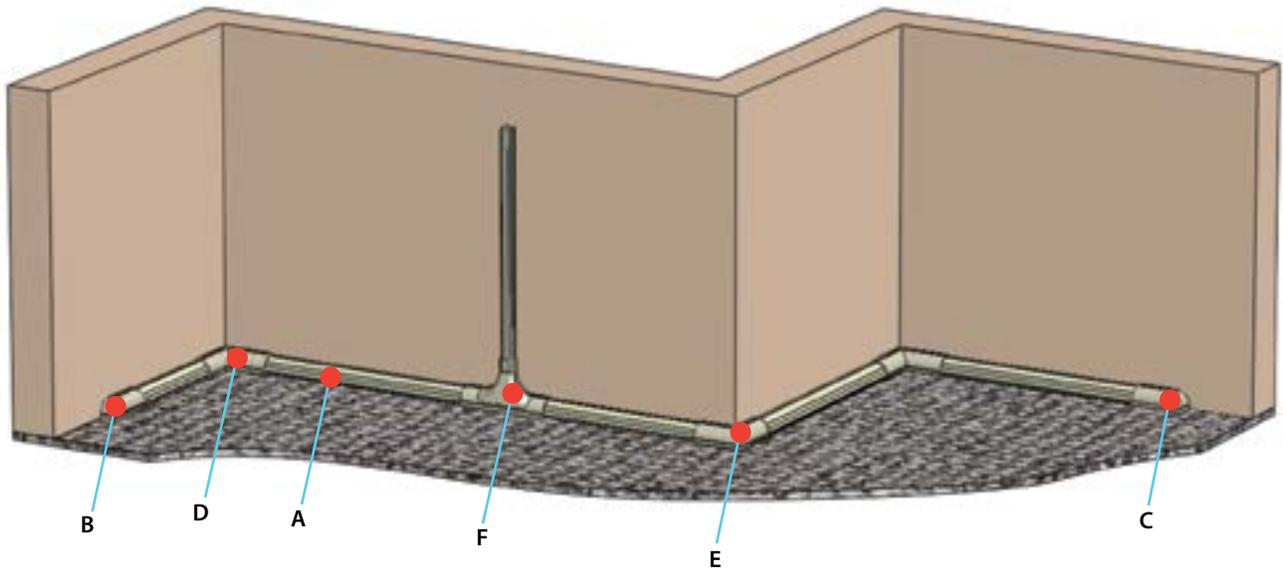

Multilink's 1/4-Round raceway system was designed to house cabling where the wall meets the floor, and can also be where the wall meets the ceiling. The cover is hinged, and the accessory pieces snap over the outside of the raceway for ease of installation. The molding transitions to Multilink's standard MRM-75 latch duct and square moldings by use of the "T" fitting.

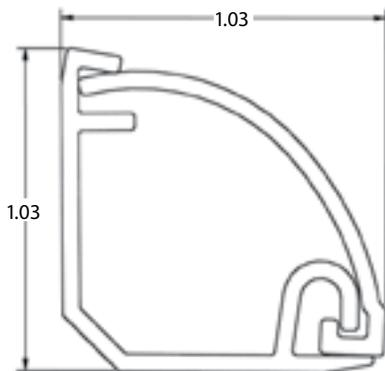

MOLDING

Stock ID	Part #	Description	Color	UOM
A	039-187-21	MRQH14-IV	Ivory	320'/ctn
A	039-187-22	MRQH14-W	White	320'/ctn
A	039-187-20	MRQH14-LW	Linen White	320'/ctn

Quarter Round Molding



LEFT ENDCAP

	Stock ID	Part #	Description	Color	UOM
B	039-219-21	MRQH14-LEC-IV	Left End Cap 1/4 Round	Ivory	10/Pack
B	039-219-22	MRQH14-LEC-W	Left End Cap 1/4 Round	White	10/Pack
B	039-219-20	MRQH14-LEC-LW	Left End Cap 1/4 Round	Linen White	10/Pack



RIGHT ENDCAP

	Stock ID	Part #	Description	Color	UOM
C	039-218-21	MRQH14-REC-IV	Right End Cap 1/4 Round	Ivory	10/Pack
C	039-218-22	MRQH14-REC-W	Right End Cap 1/4 Round	White	10/Pack
C	039-218-20	MRQH14-REC-LW	Right End Cap 1/4 Round	Linen White	10/Pack



INSIDE CORNER

	Stock ID	Part #	Description	Color	UOM
D	039-215-21	MRQH14-IE-IV	Inside Elbow 1/4 Round	Ivory	10/Pack
D	039-215-22	MRQH14-IE-W	Inside Elbow 1/4 Round	White	10/Pack
D	039-215-20	MRQH14-IE-LW	Inside Elbow 1/4 Round	Linen White	10/Pack



OUTSIDE CORNER

	Stock ID	Part #	Description	Color	UOM
E	039-216-21	MRQH14-OE-IV	Outside Elbow 1/4 Round	Ivory	10/Pack
E	039-216-22	MRQH14-OE-W	Outside Elbow 1/4 Round	White	10/Pack
E	039-216-20	MRQH14-OE-LW	Outside Elbow 1/4 Round	Linen White	10/Pack



T-FITTING

	Stock ID	Part #	Description	Color	UOM
F	039-217-21	MRQH14-T-IV	Drop T 1/4 Round	Ivory	10/Pack
F	039-217-22	MRQH14-T-W	Drop T 1/4 Round	White	10/Pack
F	039-217-20	MRQH14-T-LW	Drop T 1/4 Round	Linen White	10/Pack



SEAM COVER

	Stock ID	Part #	Description	Color	UOM
	039-214-21	MRQH14-SC-IV	Seam Cover 1/4 Round	Ivory	10/Pack
	039-214-22	MRQH14-SC-W	Seam Cover 1/4 Round	White	10/Pack
	039-214-20	MRQH14-SC-LW	Seam Cover 1/4 Round	Linen White	10/Pack

Not Shown

Hinged Overlay Molding

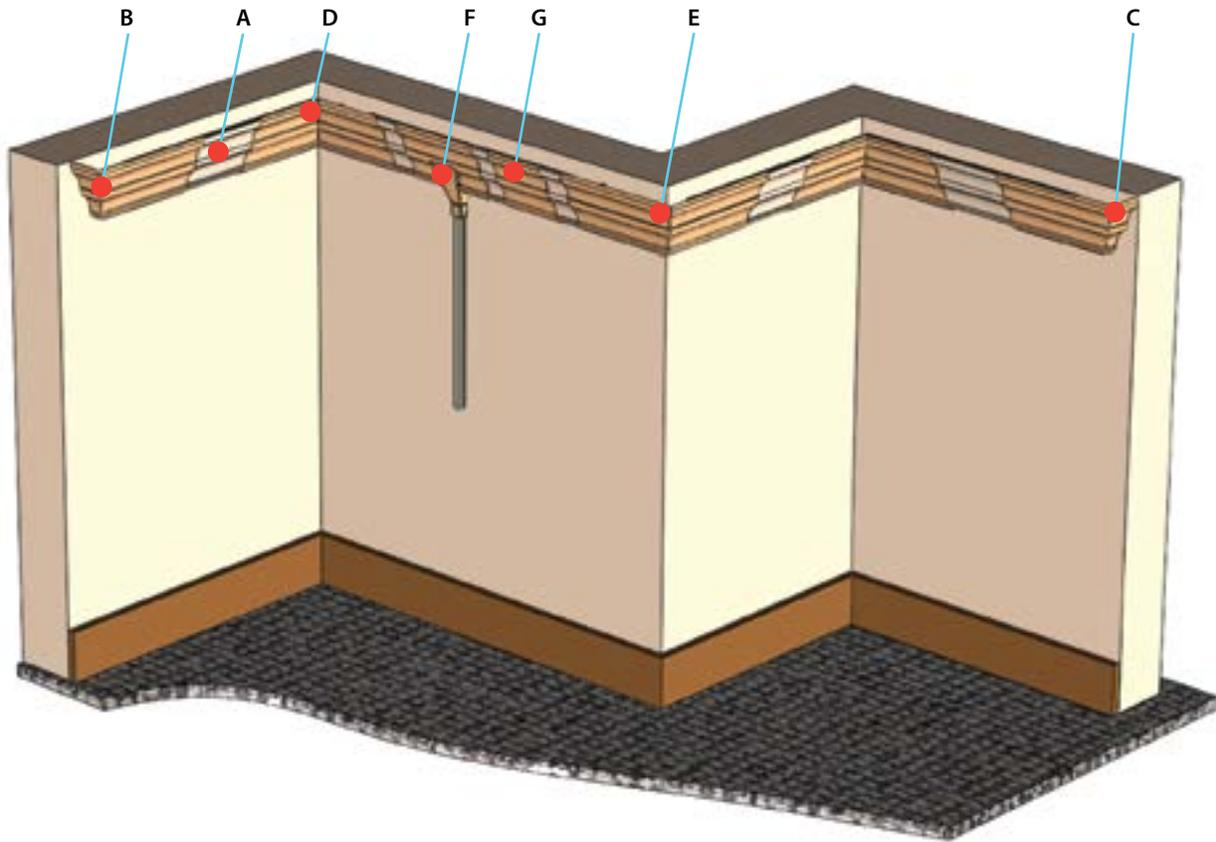

Overlay Molding™ was designed to be installed over an existing provider’s molding system. It is a two piece design, which allows for access to the first molding system without disconnecting any cables. The cover of the overlay simply snaps onto the base which is mounted below the existing molding and “covers up” the existing molding and the new base. The base of the Overlay Molding™ has a smooth co-extruded flexible cable keeper which won’t damage any cables during installation or removal. The corner pieces include bend radius protectors to maintain the minimum bend radius of 1”. Cover is hinged for ease of access and mounting.

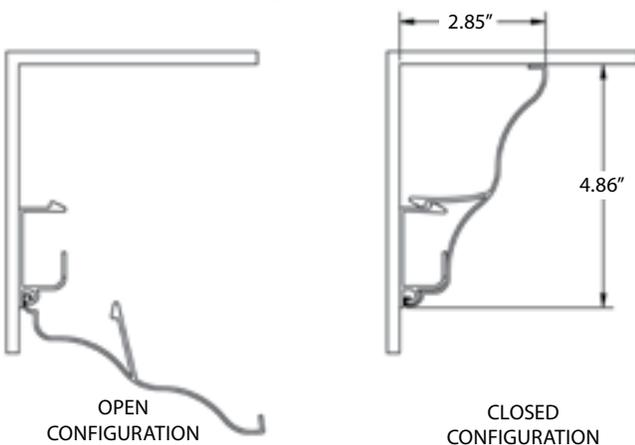

MOLDING

Stock ID	Part #	Description	Color	UOM
A 649-065-11	MRWH15-IV	Hinged Cover Molding	Ivory	80'/ctn
A 649-065-12	MRWH15-W	Hinged Cover Molding	White	80'/ctn
A 649-065-10	MRWH15-LW	Hinged Cover Molding	Linen White	80'/ctn

Hinged Overlay Molding

Left End Cap



	Stock ID	Part #	Description	Color	UOM
B	649-053-21	MRWH15-EC-L-IV	Left End Cap Hinged Cover Molding	Ivory	10/Pack
B	649-053-22	MRWH15-EC-L-W	Left End Cap Hinged Cover Molding	White	10/Pack
B	649-053-20	MRWH15-EC-L-LW	Left End Cap Hinged Cover Molding	Linen White	10/Pack

Right End Cap



	Stock ID	Part #	Description	Color	UOM
C	649-054-21	MRWH15-EC-R-IV	Right End Cap Hinged Cover Molding	Ivory	10/Pack
C	649-054-22	MRWH15-EC-R-W	Right End Cap Hinged Cover Molding	White	10/Pack
C	649-054-20	MRWH15-EC-R-LW	Right End Cap Hinged Cover Molding	Linen White	10/Pack

Inside Corner w/Bend Radius



	Stock ID	Part #	Description	Color	UOM
D	039-405-11	MRWH15-ICR-IV	Inside Corner & Radius Hinged Cover Molding	Ivory	10/Pack
D	039-405-12	MRWH15-ICR-W	Inside Corner & Radius Hinged Cover Molding	White	10/Pack
D	039-405-10	MRWH15-ICR-LW	Inside Corner & Radius Hinged Cover Molding	Linen White	10/Pack

Outside Corner w/Bend Radius



	Stock ID	Part #	Description	Color	UOM
E	039-404-11	MRWH15-OCR-IV	Outside Corner & Radius Hinged Cover Molding	Ivory	10 Pack
E	039-404-12	MRWH15-OCR-W	Outside Corner & Radius Hinged Cover Molding	White	10 Pack
E	039-404-10	MRWH15-OCR-LW	Outside Corner & Radius Hinged Cover Molding	Linen White	10 Pack

T-Fitting w/Bend Radius



	Stock ID	Part #	Description	Color	UOM
F	039-406-11	MRWH15-TRT-IV	T-Fitting & Radius Hinged Cover Molding	Ivory	10/Pack
F	039-406-12	MRWH15-TRT-W	T-Fitting & Radius Hinged Cover Molding	White	10/Pack
F	039-406-10	MRWH15-TRT-LW	T-Fitting & Radius Hinged Cover Molding	Linen White	10/Pack

Seam Cover



	Stock ID	Part #	Description	Color	UOM
G	649-060-21	MRWH15-SC-IV	Seam Cover Hinged Cover Molding	Ivory	10/Pack
G	649-060-22	MRWH15-SC-W	Seam Cover Hinged Cover Molding	White	10/Pack
G	649-060-20	MRWH15-SC-LW	Seam Cover Hinged Cover Molding	Linen White	10/Pack

Square Plastic Molding Exterior Grade

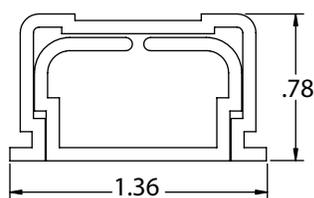
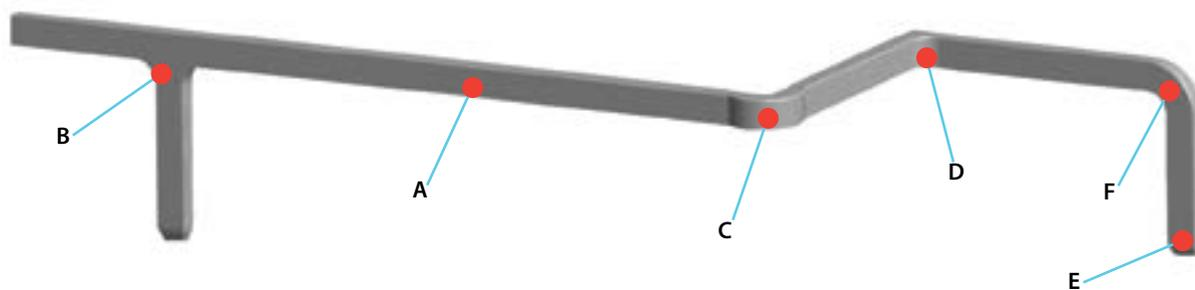

MRC12

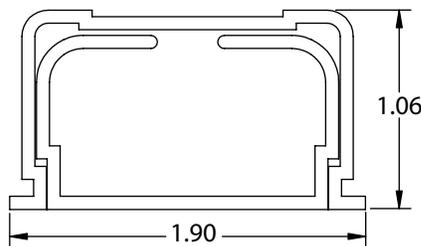

MRC17

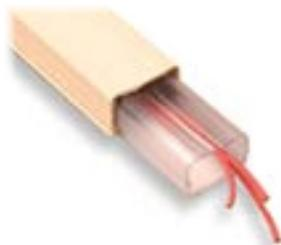

Square Plastic Molding

Stock ID	Part #	Description	UOM	
A	10-9465	MRC12-E-IV	Sq. Plastic Molding w/ Non-Adhesive Backing Exterior Grade	160/Feet
A	10-9423	MRC17-E-IV	Sq. Plastic Molding w/ Non-Adhesive Backing Exterior Grade	160/Feet



Not Sold Separately

T-FITTING

Stock ID	Part #	Description	UOM	
B	10-9731	MRF12-TRT-E-IV	T-Fitting & Radius for Sq. Plastic Exterior Grade	10/Pack
B	10-9734	MRF17-TRT-E-IV	T-Fitting & Radius for Sq. Plastic Exterior Grade	10/Pack



Not Sold Separately

OUTSIDE CORNER

Stock ID	Part #	Description	UOM	
C	10-9417	MRF12-OCR-E-IV	Outside Corner and Radius for Sq. Plastic Exterior Grade	10/Pack
C	10-9427	MRF17-OCR-E-IV	Outside Corner and Radius for Sq. Plastic Exterior Grade	10/Pack



Not Sold Separately

INSIDE CORNER

Stock ID	Part #	Description	UOM	
D	10-9415	MRF12-ICR-E-IV	Inside Corner and Radius for Sq. Plastic Exterior Grade	10/Pack
D	10-9425	MRF17-ICR-E-IV	Inside Corner and Radius for Sq. Plastic Exterior Grade	10/Pack

Square Plastic Molding Exterior Grade



Not Sold Separately

FLAT ELBOW

Stock ID	Part #	Description	UOM
E 10-9419	MRF12-FER-E-IV	Flat Elbow and Radius for Sq. Plastic Exterior Grade	10/Pack
E 10-9429	MRF17-FER-E-IV	Flat Elbow and Radius for Sq. Plastic Exterior Grade	10/Pack



END CAP

Stock ID	Part #	Description	UOM
F 10-9729	MRF12-EC-E-IV	End Cap for Sq. Plastic Exterior Grade	10/Pack
F 10-9730	MRF17-EC-E-IV	End Cap for Sq. Plastic Exterior Grade	10/Pack



SEAM COVER

Stock ID	Part #	Description	UOM
- 10-9421	MRF12-JC-E-IV	Seam Cover for Sq. Plastic Exterior	10/Pack
- 10-9431	MRF17-JC-E-IV	Seam Cover for Sq. Plastic Exterior	10/Pack



TRANSITION FITTING

Stock ID	Part #	Description	UOM
- 649-052-20	MRF12-TF-E-IV	Transition Fitting	10/Pack
- 649-051-20	MRF17-TF-E-IV	Transition Fitting	10/Pack



SLACK BOX ENTRY FITTING

Stock ID	Part #	Description	UOM
- 039-208-20	MRF12-SBE-E-IV	Slack Box Entry Fitting	10/Pack
- 039-209-20	MRF17-SBE-E-IV	Slack Box Entry Fitting	10/Pack

Exterior Grade Material is Only Available in Exterior Ivory

Fiber Optic Exterior Slack Storage Box



See page 205 for additional info and fill chart

Stock ID	Description	Dimensions	Color	Std. CRT Size	UOM
020-004-23	Slack Box, Exterior with 3, 1" holes	4.8 L x 4.8 W x 2.2 D	Ivory	1	Each
020-004-24	Slack Box, Exterior without holes	4.8 L x 4.8 W x 2.2 D	Ivory	1	Each

Steel Molding

Tuff Top Coating for Olympic Steel Molding
Category 5, 5E & 6 - 1" Bend Radius Compliant

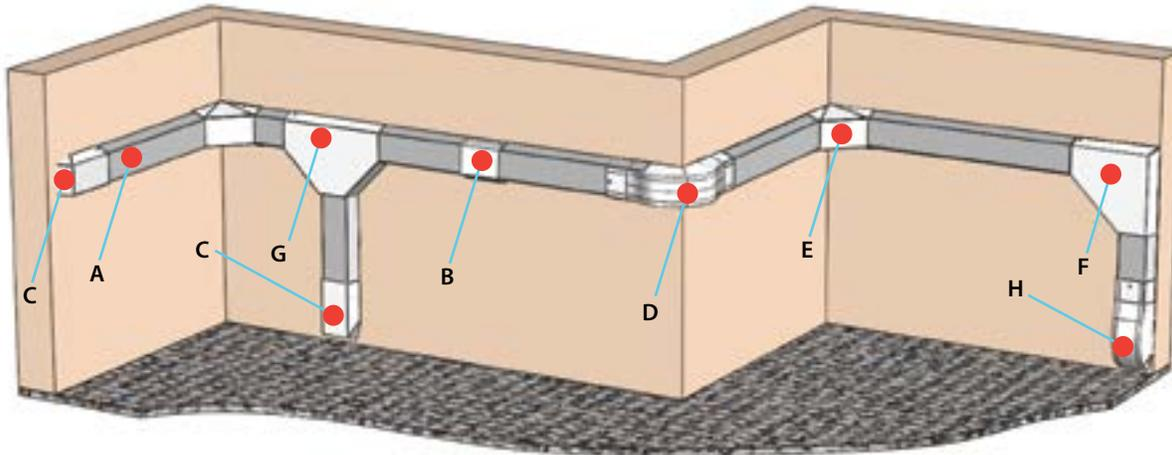

Steel Raceway		Stock ID					
Description	Beige	Brick Red	Brown	White	Std. CRT Size	UOM	
A 84030-CMM 3/4"	20117	20119	20118	20115	224 ft	Each	
A 84120-CMM 1-1/4"	20137	20139	20138	20136	224 ft	Each	
A 84200-CMM 2"	20167	20169	20168	20171	192 ft	Each	
A 84300-CMM 3"	20194	20195	20196	20197	96 ft	Each	

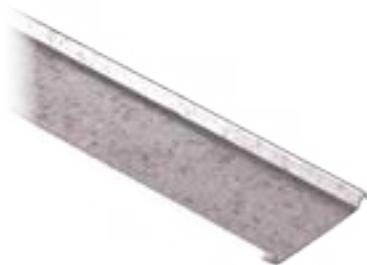

Full Length Metal Backing				
Stock ID	Description	Std. CRT Size	UOM	
A 25913	84030-MBL / Full length Metal Backing for 3/4" Metal Molding	224 ft	Each	
A 25933	84120-MBL / Full Length Metal Backing for 1-1/4" Metal Molding	224 ft	Each	
A 25993	84200-MBL / Full Length Metal Backing for 2" Metal Molding	192 ft	Each	
A 25934	84300-MBL / Full Length Metal Backing for 3" Metal Molding	96 ft	Each	

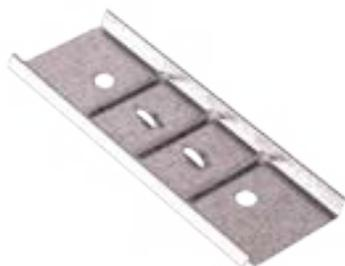

5" Long Mounting Brackets				
Stock ID	Description	Std. CRT Size	UOM	
A 25912	84032-MB / 3/4" Mounting Brackets	10/Pack	Each	
A 25932	84122-MB / 1 1/4" Mounting Brackets	10/Pack	Each	
A 25962	84205-MB / 2" Mounting Brackets	10/Pack	Each	
A 25963	84306-MB / 3" Mounting Brackets	10/Pack	Each	

To be placed every 4 ft.

Steel Molding

Tuff Top Coating for Olympic Steel Molding
Category 5, 5E & 6 - 1" Bend Radius Compliant



Seam Covers		Stock ID					
Description		Beige	Brick Red	Brown	White	Carton Qty.	UOM
B	84033-SCM 3/4"	25917	25919	25918	25920	10/Pack	Each
B	84122-SCM 1-1/4"	25937	25939	25938	25940	10/Pack	Each
B	84222-SCM 2"	25967	25969	25968	25961	10/Pack	Each
B	84302-SCM 3"	25009	25008	25109	25007	10/Pack	Each

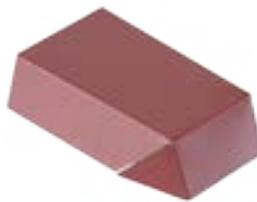

End Cap		Stock ID					
Description		Beige	Brick Red	Brown	White	Carton Qty.	UOM
C	84033-ECM 3/4"	25317	25319	25318	27332	10/Pack	Each
C	84123-ECM 1-1/4"	25337	25339	25338	27333	10/Pack	Each
C	84203-ECM 2"	25367	25369	25368	27334	10/Pack	Each
C	84303-ECM 3"	25396	25395	25394	25005	10/Pack	Each



Entry Hoof		Stock ID					
Description		Beige	Brick Red	Brown	White	Carton Qty.	UOM
H	84123-ECM2 1-1/4"	10-9311	10-9312	10-9310	10-9309	10/Pack	Each
H	84203-ECM2 2"	10-9315	10-9316	10-9314	10-9313	10/Pack	Each

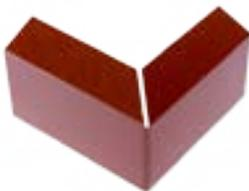

Outside Corner		Stock ID					
Description		Beige	Brick Red	Brown	White	Carton Qty.	UOM
D	84037-OEM 3/4"	25117	25119	25118	27326	10/Pack	Each
D	84127-OEM 1-1/4"	25137	25139	25138	27327	10/Pack	Each
D	84207-OEM 2"	25167	25169	25168	27328	10/Pack	Each
D	84307-OEM 3"	25194	25195	25196	25002	10/Pack	Each



Outside Corners w/ Bend Radius Protection		Stock ID					
Description		Beige	Brick Red	Brown	White	Carton Qty.	UOM
D	84127-OEM2 1-1/4"	10-9303	10-9304	10-9302	10-9301	10/Pack	Each
D	84207-OEM2 2"	10-9307	10-9308	10-9306	10-9305	10/Pack	Each

Steel Molding

Tuff Top Coating for Olympic Steel Molding
 Category 5, 5E & 6 - 1" Bend Radius Compliant



Inside Corner		Stock ID					
Description		Beige	Brick Red	Brown	White	Carton Qty.	UOM
E	84036-IEM 3/4"	25017	25019	25018	27323	10/Pack	Each
E	84126-IEM 1-1/4"	25037	25039	25038	27324	10/Pack	Each
E	84206-IEM 2"	25067	25069	25068	27325	10/Pack	Each
E	84306-IEM 3"	25096	25095	25094	25001	10/Pack	Each

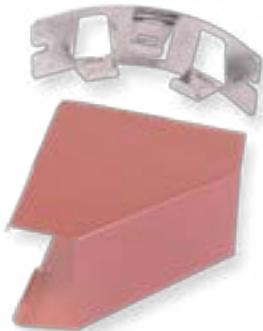

Inside Corners w/ Bend Radius Protection		Stock ID					
Description		Beige	Brick Red	Brown	White	Carton Qty	UOM
E	84126-IEM2 1-1/4"	10-9295	10-9296	10-9294	10-9293	10/Pack	Each
E	84206-IEM2 2"	10-9299	10-9300	10-9298	10-9297	10/Pack	Each



Right Angles		Stock ID					
Description		Beige	Brick Red	Brown	White	Carton Qty.	UOM
F	84034-FEMB 3/4"	25217	25219	25218	27329	10/Pack	Each
F	84124-FEMB 1-1/4"	25237	25239	25238	27330	10/Pack	Each
F	84204-FEMB 2"	25267	25269	25268	27331	10/Pack	Each
F	84304-FEMB 3"	25294	25295	25296	25003	10/Pack	Each



Right Angles w/ Bend Radius Protection		Stock ID					
Description		Beige	Brick Red	Brown	White	Carton Qty	UOM
F	84124-FEM2 1-1/4"	10-9278	10-9279	10-9277	10-9276	10/Pack	Each
F	84204-FEM2 2"	10-9286	10-9287	10-9285	10-9284	10/Pack	Each



4-Way Fitting		Stock ID					
Description		Beige	Brick Red	Brown	White	Carton Qty	UOM
	4WF-2 2"	038-007-22	038-007-21	038-007-24	038-007-23	10/Pack	Each
	4WF-3 3"	038-005-22	038-005-21	038-005-24	038-005-23	10/Pack	Each

Not Shown On Drawing

Steel Molding

Tuff Top Coating for Olympic Steel Molding
Category 5, 5E & 6 - 1" Bend Radius Compliant



Image Altered For Clarity

T-Fitting		Stock ID					
Description		Beige	Brick Red	Brown	White	Carton Qty.	UOM
G	84038-TMB 3/4"	25417	25419	25418	25420	10/Pack	Each
G	84128-TMB 1-1/4"	25437	25439	25438	25440	10/Pack	Each
G	84208-TMB 2"	25467	25469	25468	25466	10/Pack	Each
G	84308-TMB 3"	25494	25495	25496	25006	10/Pack	Each

T-Fitting w/ Bend Radius Protection		Stock ID					
Description		Beige	Brick Red	Brown	White	Carton Qty.	UOM
G	84128-TM2 1-1/4"	10-9282	10-9283	10-9281	10-9280	10/Pack	Each
G	84208-TM2 2"	10-9290	10-9291	10-9289	10-9288	10/Pack	Each

T-Reducer Fitting		Stock ID					
Description		Beige	Brick Red	Brown	White	Carton Qty.	UOM
	84128-03-T 1-1/4" - 3/4"	25540	N/A	N/A	N/A	10/Pack	Each
	84208-03-T 2" - 1-1/4"	25567	25569	25568	25566	10/Pack	Each
	84308-03-T 3" - 1-1/4"	25594	25595	25596	25593	10/Pack	Each

Bell Flanges		Stock ID					
Description		Beige	Brick Red	Brown	White	Carton Qty.	UOM
	84030-JBM 3/4"	25617	25619	25618	27321	10/Pack	Each
	84120-JBM 1-1/4"	25637	25639	25638	25636	10/Pack	Each
	84200-JBM 2"	25667	25669	25668	27322	10/Pack	Each
	84300-JBM 3"	25694	25695	25696	25004	10/Pack	Each

2" Metal Molding In-Line Spool				
Stock	Description	Color	Max. Fill	UOM
038-008-22	2" In-Line Spool	Beige	24 Ft	Each
038-008-21	2" In-Line Spool	Brick Red	24 Ft	Each
038-008-24	2" In-Line Spool	Brown	24 Ft	Each
038-008-23	2" In-Line Spool	White	24 Ft	Each

3" Metal Molding In-Line Spool				
Stock	Description	Color	Max. Fill	UOM
038-009-22	3" In-Line Spool	Beige	28 Ft	Each
038-009-21	3" In-Line Spool	Brick Red	28 Ft	Each
038-009-24	3" In-Line Spool	Brown	28 Ft	Each
038-009-23	3" In-Line Spool	White	28 Ft	Each

Accessories

Tuff Top Coating for Olympic Steel Molding Category 5, 5E & 6 - 1" Bend Radius Compliant



CUTTING TOOL

Stock ID	Description	Weight Lbs.	UOM
33815	84J1251 - Cutting Tool For Steel Molding	-	Each



ENTRY TOOL

Stock ID	Description	Weight Lbs.	UOM
33800	84002-ET - Entry Tool for Molding	0.05	Each



TOUCH UP PAINT

Stock ID	Description	Weight Lbs.	UOM
12715	Brown Touch Up Paint	0.70	Each
12720	Beige Touch Up Paint	0.70	Each
12717	Brick Red Touch Up Paint	0.70	Each
12718	White Touch Up Paint	0.70	Each

Multilink Plastic Flush Wall Entry Plug With Built-In Bend Radius System Single Feed Thru Bushing



- Designed to meet the special requirements of the telecommunications industry
- It provides unequalled holding power in less-than-perfect holes through many kinds of construction materials, including masonry walls
- Each bushing has multiple reverse barbs which flex to fill the hole and secure themselves to prevent easy pull-out after insertion



Stock ID	Description	UOM
10-6052	Single Feed-thru Bushing For RG-6 Black	Each
649-022-12	Fiber Plug 3mm	Each

Surface Mount Junction Boxes & Face Plates

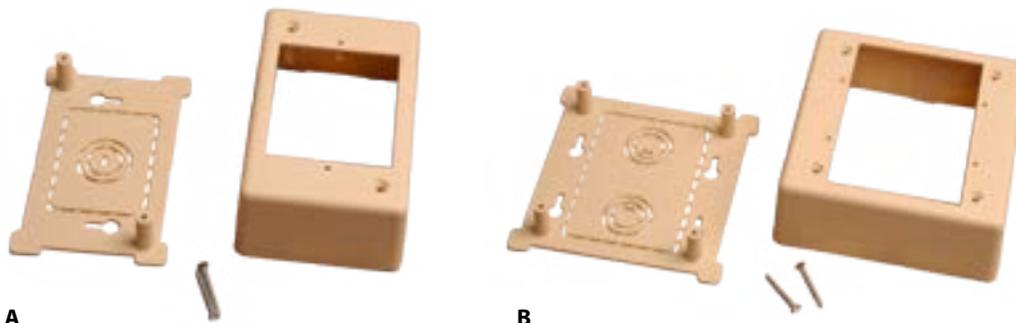
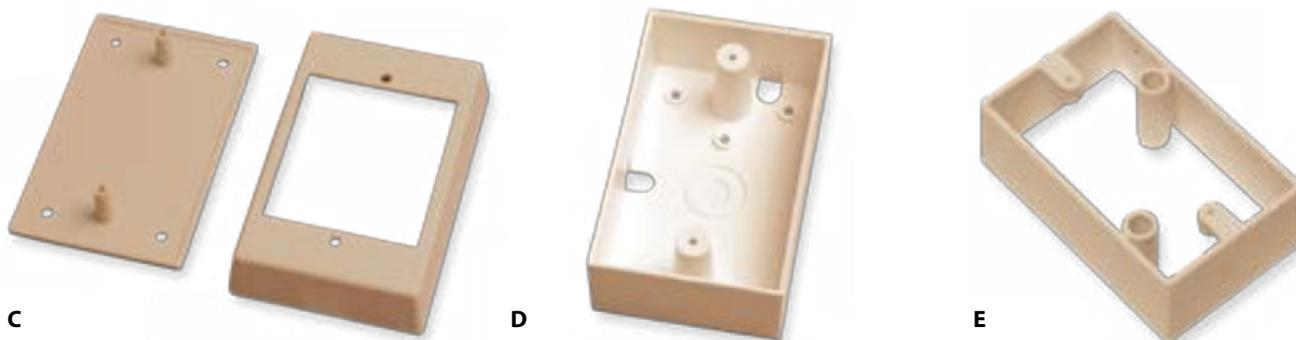

Figure	Stock ID	Description	Dimensions	Wt. Lbs.	UOM
A	99580K	MJB-1-I Ivory Single Gang Surface Mount Box	3.25" x 5" x 2"	0.20	Each
-	99581K	MJB-1-WH White Single Gang Surface Mount Box	3.25" x 5" x 2"	0.20	Each
-	99584K	MJB-1-OW Office White Single Gang Surface Mount Box	3.25" x 5" x 2"	0.20	Each
B	99582K	MJB-2-I Ivory Double Gang Surface Mount Box	5" x 5.25" x 2"	0.20	Each
-	99583K	MJB-2-WH White Double Gang Surface Mount Box	5" x 5.25" x 2"	0.20	Each
-	99585K	MJB-2-OW Office White Double Gang Surface Mount Box	5" x 5.25" x 2"	0.20	Each



This 2-piece wall plate box offers 4 knockout entry holes which are ideal for a 4-way junction box. The 2-piece wall box can easily be mounted to an uneven surface.

This wall plate box with a back has the same features as the 84421-SWB along with a full backing and a 2 stage knockout with 1/2" ID and 1" OD. Also four mounting holes and two knockouts on each side.

Installing directional taps and passive equipment on hard concrete walls or areas where there are no outlet holes can be a problem without the use of a junction box.

2 Piece Wall Plate Box					
Figure	Stock ID	Part #	Color	Dimensions	UOM
C	33407	84512-SWB	Beige	4.5" x 2.5" x 1"	Each
C	33408	84512-SWB	Brown	4.5" x 2.5" x 1"	Each
C	33409	84512-SWB	White	4.5" x 2.5" x 1"	Each

Wall Plate Box/Junction Box With Full Backing					
Figure	Stock ID	Part #	Color	Dimensions	UOM
D	33417	84430-SWB	Beige	4.5" x 2.5" x 1"	Each
D	33418	84430-SWB	Brown	4.5" x 2.5" x 1"	Each
D	33416	84430-SWB	White	4.5" x 2.5" x 1"	Each

Wall Plate Box/Junction Box					
Figure	Stock ID	Part #	Color	Dimensions	UOM
E	33427	84421-SWB	Beige	4.5" x 2.5" x 1"	Each
E	33428	84421-SWB	Brown	4.5" x 2.5" x 1"	Each
E	33429	84421-SWB	White	4.5" x 2.5" x 1"	Each

Slack Storage Devices



(Knockouts For MRM75, MRC75 & Single Fiber Raceway)

Stock ID	Description	Dimensions	Color	UOM
10-9433	MRS-3TB-LW	3.95" x 3.95" x 1.19"	Linen White	Each
10-9434	MRS-3TB-IV	3.95" x 3.95" x 1.19"	Ivory	Each



(Knockouts For MRM75, MRC75, MRM12 & MRC12)

Stock ID	Description	Dimensions	Color	UOM
020-026-10	MRS-6TB-LW	5.00" x 5.00" x 2.00"	Linen White	Each
020-026-11	MRS-6TB-IV	5.00" x 5.00" x 2.00"	Ivory	Each

Fiber Optic Exterior Slack Storage Box

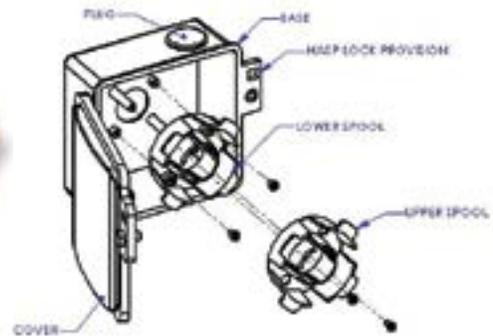
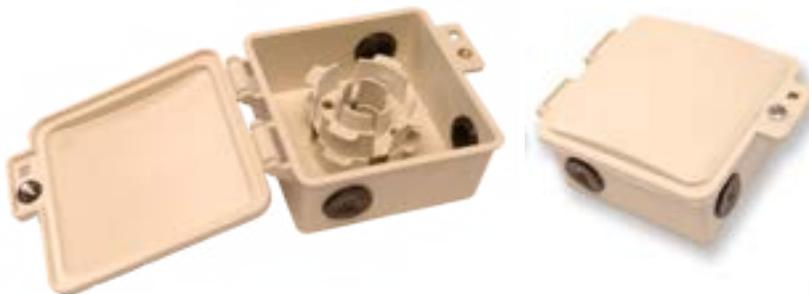

Multilink's OSP slack storage box is 5" W x 5" L x 2" D. This OSP slack storage box is used for exterior slack storage applications using 3mm single fiber cable. There are two stackable storage spools that allow storage of multiple single fiber cable drops. Both of these spools are removable. In an instance where only one spool is sufficient, the spool can either be secured at a lower level or can be mounted at an elevation onto the risers off the back of the inside of the box as a spool on the upper level. This allows additional storage under the spool. There are three entry points sealed with removable cap plugs, or it can be ordered without holes. The diameter of each entry hole is 1 inch. The box is equipped with a hex bolt (with a retainer) that can be secured using a standard 216C type wrench. In addition to the above, the box is also equipped with a provision for a hasp lock. A built-in hinge allows captive and non-captive flexibility.

FILL CHART			
Bend Radius	Cable Type	EIA/TIA 40%	Maximum Fill
1.263 Inches	3mm Fiber Optic Cable	5.2 1.58 M	13' 3.9 MRT
1.211 Inches	3mm Fiber Optic Cable	4.4 1.34 M	11' 3.52 MRT

Stock ID	Description	Dimensions	Color	Std. CRT Size	UOM
020-004-23	Slack Box, Exterior with 3, 1" holes	4.8 L x 4.8 W x 2.2 D	Ivory	1	Each
020-004-24	Slack Box, Exterior without holes	4.8 L x 4.8 W x 2.2 D	Ivory	1	Each

Digital Converter Totes

- Transport made easy
- Protect your hardware while improving your image and organization

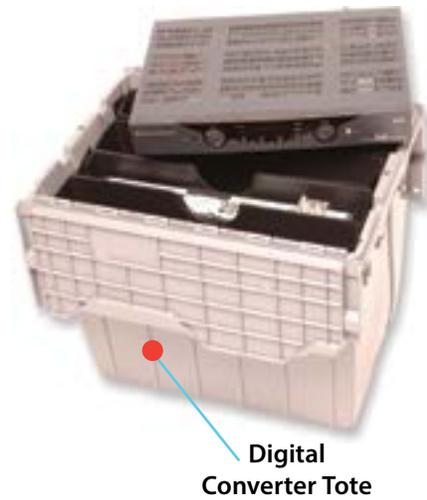

Converter Bags For CSR's
When receiving converters back,
the bags snuff out insects



Portable Converter Totes Transport Made Easy

Not only holds and protects DVR and Converters, but also holds VOIP installation cables, high speed modems and other hardware and accessories

This Product Has Been Discontinued

44" Extended
21" Retracted

Retractable Handle

(1) Top and (2) Side Handles

Double

Custom Logo Available

20"

17"

23"

Information Window

(3) Adjustable Padded Sections

Inside Velcro Pocket

Rolling Digital Converter Tote

Stock ID	10-9440
Description	Rolling Digital Converter Tote, Padded
Dimensions	Outside: 23" W x 20" H x 17" D Inside: 21" W x 16" H x 13" D
Weight	-
Material	Canvas, Padded
UOM	Each



The Tech Bag

Stock ID	10-8139 / Custom Logos Available
Description	Techbag Tote For Transporting Converters and Hardware
Dimensions	22" L x 8" W x 16" D
Weight	3.0 lbs.
Material	Canvas, Padded
UOM	Each

Plastic Converter Tote

Great for transporting in the warehouse and back to repair center

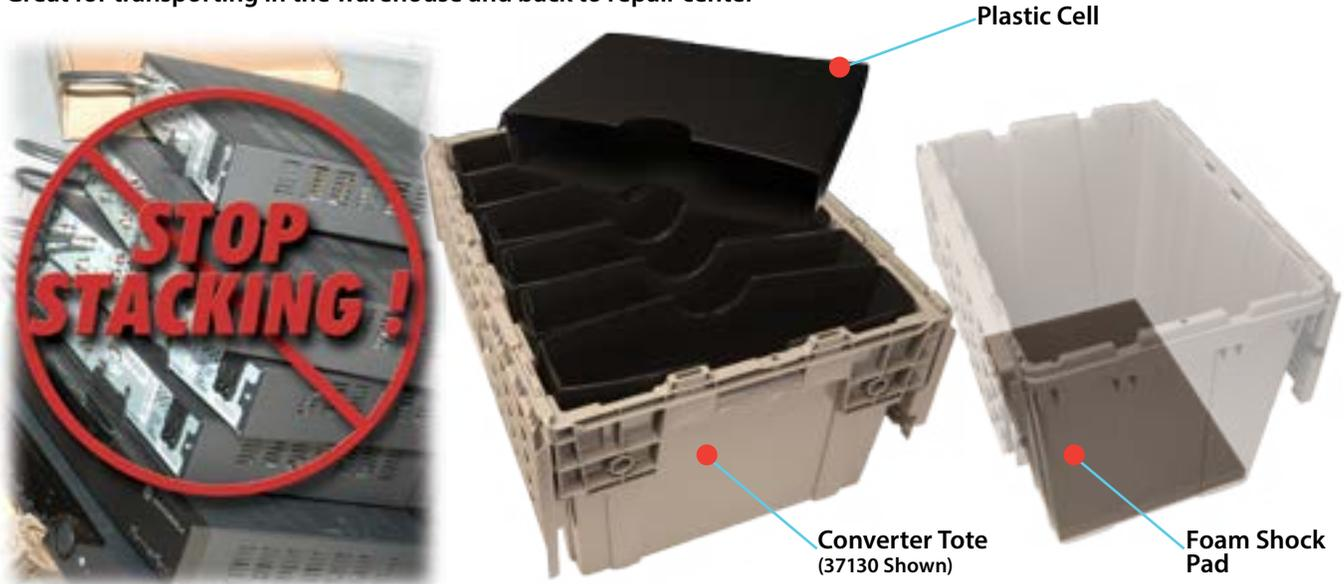

Features & Benefits

- Lockable security
- Easy to maintain
- Washable
- Cell/inserts are replaceable
- Attached cover
- Highly durable
- Stackable

Kit Includes:

- Tote
- Shock Pad
- Cells

Part#	Description	Capacity	Dimensions	UOM
37130K	242015-B Gray Plastic Tote Kit	6 Converters	25" L x 18" W x 14.88" H	Each
37130	242015-B Gray Plastic Tote (Tote Only)	6 Converters	25" L x 18" W x 14.88" H	Each
37333	242517-P Foam Shock Pad Fits Bottom of Tote 37130	-	-	Each
37111K	221157-B Gray Plastic Tote Kit	4 Converters	19.75" L x 14.5" W x 16.88" H	Each
37111	221157-B Gray Plastic Tote (Tote Only)	4 Converters	19.75" L x 14.5" W x 16.88" H	Each
37112	218134-P Foam Shock Pad Fits Bottom of Tote 37111	-	-	Each
960-129-10	Plastic Converter Cell 17-3/4 X 3 X 13-5	1 Converter	17.75" L x 3.0" W x 13.5" H	Each



7/16" TORQUE WRENCH

Part#	Description	Dimensions	UOM
38946	5510-TWP, Torque Wrench 10.5" Inch/Pounds	7/16"	Each

Converter Bags & Disposable Shoe Covers



Features & Benefits

- Converter Dispenser Repackaging bags are available in quantities of 500 per easy to use dispenser box
- Each bag has space to write the date, the subscriber's name, address, and account number along with an area for comments regarding the performance or condition of the converter
- Each bag has a built-in plastic tie strip to seal the bag and is made from a durable 2 mil. clear poly film
- Custom imprinting and/or logos are available Please call Customer Service for details
- Reduces the roach and pest problems along with the handling of the converters in the field and office area
- Converter disconnections, upgrades, and repair problems are handled quickly and easily with write-on disposable bags
- Operations run more efficiently
- Reduces scratches
- Keeps converter dust free while sitting on the shelf

Features & Benefits

- The Disposable Shoe Covers are made of poly-latex, no-skid material
- The Disposable Shoe cover fits a size 16 shoe and lower (one size fits most)
- The Disposable Shoe Covers are a new and inexpensive product from Multilink used to prevent tracking mud, dirt, grease, etc. on the floors and carpet of subscribers
- No more angry phone calls from subscribers upset with dirt on their floors and carpets!
- No more carpet cleaning bills from the dirty floors of subscribers
- Improve image of the cable system as being professional, "One who cares about work and customers!"
- Improve the productivity of the installer because he/she doesn't have to spend time taking his/her boots/shoes off and on before entering the home

Figure	Part #	Description	Dimensions	UOM
A	10-8141	CB-2026 Converter Bag	20" x 26"	500/Box
B	37911	SCJM-402-XD Work Boot & Regular Shoe Style	-	50 Pair/Box
C	37922	SCJM-402-DW High Top Boot Style	-	50 Pair/Bag
D	37933	Shoe Cover XXL Butterfly Style w/ Serged Seam		75 Pair/Bag
D	37934	Shoe Cover Universal Size w/ Serged Seam		75 Pair/Bag
D	37935	Shoe Cover XL Size w/ Serged Seam		75 Pair/Bag



Reusable Shoe Covers

Stock ID	37937
Description	Reusable Shoe Covers
Size	One Size Fits Most
Material	Polyester Top, Anti-slide Fabric Bottom. Elastic Band Around the Opening
UOM	Pair

Terms And Conditions Of Sale

Price and Payment: All prices, unless otherwise stated, are F.O.B. shipping point and are exclusive of any federal, state, local or other taxes. Any applicable taxes are the responsibility of the Purchaser and shall be added to the invoice unless MULTILINK is provided the appropriate, valid exemption certificate by Purchaser. All prices are subject to change without notice. Shipments of ten percent (10%) more or less than the order quantity constitute completed orders, unless previously agreed to by both Purchaser and MULTILINK.

Invoices are payable in full within thirty (30) days following invoice date. A discount of one percent (1%) is allowable on invoices paid within (10) days following invoice date: this discount also applies to those orders shipped C.O.D. or cash in advance. Invoices outstanding past thirty (30) days following invoice date will be subject to a late payment charge of one and one half percent (1-1/2%) per month. Failure to pay any invoice by its due date makes subsequent invoices due immediately regardless of the terms herein. MULTILINK may option to withhold subsequent shipments until the account in question is settled to MULTILINK'S satisfaction.

Acceptance: All orders subject to acceptance by MULTILINK. Once placed and accepted, any order may be cancelled only upon terms exempting MULTILINK against all loss with the consent of MULTILINK.

Title and Risk of Loss: Title and risk of loss on all material sold by MULTILINK shall pass to Purchaser upon delivery of said materials to a common carrier regardless of freight terms stated or method of payment of transportation charges.

Transportation charges: Most shipments are via United Parcel Service and are prepaid and billed; however, MULTILINK reserves the right to specify routing of shipments. Truck shipments will be made prepaid.

Non-conformance return: All materials sold by MULTILINK are non-returnable except for manufacturing defects. Upon receipt of materials, the customer will have 30 days to make a viable claim for non-conformance. Any material shown to MULTILINK'S satisfaction to be non-conforming at time of shipment will be replaced. MULTILINK will then render credit for the returned goods, provided MULTILINK shall not be responsible for claims beyond replacement value of the defective material. Before returning any material, Purchaser must obtain written material return authorization from MULTILINK.

Express warranties: MULTILINK warrants that the goods are free from any material defect in workmanship and materials under normal and proper usage for a period of one year from the date of shipment by MULTILINK. Purchaser acknowledges that no sample or model of the goods, nor any sales literature, proposals, projections, or engineering data regarding the goods are any part of the bargain between the parties. Purchaser has made, and relies solely upon, its own determination of the suitability, compatibility, performance, and uses of the goods, and acknowledges to MULTILINK that the Purchaser does not rely upon any oral or written representations or statements by MULTILINK regarding the goods, other than as expressly set forth in this Contract.

Disclaimer of Implied Warranties: IN ALL EVENTS, WITH RESPECT TO ALL GOODS SOLD, MULTILINK DISCLAIMS THE IMPLIED WARRANTY OF MERCHANTABILITY AND THE IMPLIED WARRANTY OF FITNESS FOR A PARTICULAR PURPOSE.

Limitation of Damages: IF MULTILINK BREACHES OR REPUDIATES THIS CONTRACT BY REASON OF ANY DEFECT IN THE GOODS SOLD, THEN PURCHASER IS NOT ENTITLED TO, AND WAIVES ALL RIGHTS TO RECOVER, ANY INCIDENTAL OR CONSEQUENTIAL DAMAGES, INCLUDING LOST PROFITS. Purchaser has carefully considered this limitation and is willing to bear the entire defective.

Purchaser's Exclusive Remedy: IF MULTILINK BREACHES THE WARRANTY SET FORTH ABOVE, THEN PURCHASER'S SOLE AND EXCLUSIVE REMEDY IS TO DEMAND THAT MULTILINK, AT MULTILINK'S COST, REPAIR THE GOODS, OR REPLACE THE GOODS IF, AFTER A REASONABLE NUMBER OF ATTEMPTS, THEY CANNOT BE REPAIRED. In lieu of making any repair or replacement of the Goods, Multilink may elect to refund the total purchase price, in full satisfaction of all obligations owed to Purchaser by reason of such breach, in which case Multilink's duty to pay the refund will be conditioned upon Purchaser permitting Multilink to inspect and take possession of the Goods.

Statute of Limitations: The parties desire to reduce the period of limitations to one year. Accordingly, a party must commence a cause of action for a breach of this Contract, including a breach of warranty, within one year after the cause of action has accrued.

Entire Agreement: Any term or condition contained in Purchaser's purchase order, acknowledgement form, confirmation or any other document issued by Purchaser that conflicts with any term of this Contract, or that adds to MULTILINK'S obligations under this Contract, is not part of this Contract and is not binding upon MULTILINK unless specifically identified and accepted in writing by an officer of MULTILINK. This document, including any attachments, embodies the entire agreement of the parties as to the subject matter contained in this document. There are no promises, terms, conditions, or obligations between the parties regarding the subject matter of this Contract other than those contained in this document, including any attachments. This Contract supersedes all previous communications, representations, or agreements, either verbal or written, between the parties, including any correspondence, proposals, quotes, brochures, samples, models, or specification sheets, or any other oral or written statements or representations made by any MULTILINK salesmen. Accordingly, the parties shall request that any court or tribunal called upon to consider and enforce this Contract strictly apply the "parol evidence" rule. No course of prior dealings between the parties and no usage of trade is relevant to supplement or explain any term of this Contract.

Modification of Contract: No amendment, modification, change or discharge of any term or provision of this Contract will be valid or binding on either party, and no waiver of any of the terms of this Contract will be valid or binding on either party, unless it is in writing and signed by all of the parties; and with respect to MULTILINK, signed by an officer of MULTILINK.

Non-Waiver: Failure of MULTILINK or any of its agents or representatives to comply with any of the terms or conditions herein or failure to properly notify Purchaser of any breach of these conditions shall not be deemed a waiver of any right MULTILINK has to insist upon strict compliance of these terms and conditions in subsequent agreements.

Force Majeur: MULTILINK shall not be liable for any loss, damage, delay, change in shipment schedule or failure to deliver caused by accident, fire, strike, riot, civil commotion, insurrection, war, the elements, embargo, failure of carrier, inability to obtain transportation facilities, government requirements, acts of God or public enemy, previous commitments to customers or limitations on MULTILINK'S or its suppliers' products or marketing activities or any other cause or contingency beyond MULTILINK'S control.

Freight Policy: Orders are shipped via best method as determined by MULTILINK unless specified by the Customer. Freight bills will be prepaid if shipped via common carrier under the condition that freight bills will be paid in net 7 days per ICC regulations. MULTILINK reserves the right to charge a handling fee.

Returns must be in original cartons, in resell able condition, and sent prepaid. (If merchandise was shipped to customer via UPS, it must be returned via UPS). All returns must be made within a 60-day limit and are subject to a 25% restocking charge (Special order and custom orders are non-refundable).

Claims for Shortages or Damages: Claims must be made within seven days of invoice date. All freight damages and shortages should be filed with the carrier within seven days.

Back Orders: All back orders will be retained and shipped on arrival unless otherwise notified.

NO SALESMAN, DISTRIBUTOR, REPRESENTATIVE OR OTHER AGENT IS AUTHORIZED BY MULTILINK TO GIVE ANY WARRANTY OR GUARANTEE CONTRARY TO THE STATEMENTS MADE HEREIN.

Multilink[®]
Innovation At Work



Email: engsupport@gomultilink.com
580 Ternes Ave • P.O. Box 955 • Elyria, OH 44035
Phone: 440.366.6966 • Fax: 440.366.6802
June, 2013 Volume 4



Scan these codes with your smart phone for more information on Multilink products and services.