

## Table of Contents

<b>General Safety Instructions</b> .....	2
<b>Instrument Set-up</b> .....	3
Introduction .....	3
Overview .....	3
Display .....	4
Insert batteries .....	4
Labeling .....	5
<b>Operations</b> .....	6
Switching ON/OFF .....	6
Clear .....	6
Message Codes .....	6
Beep ON/OFF .....	6
Illumination ON/OFF .....	6
Adjusting measuring reference / tripod .....	7
Multifunctional endpiece .....	7
Distance unit setting .....	8
Tilt unit setting .....	8
Timer (automatic release) .....	8
<b>Measuring Functions</b> .....	9
Measuring single distance .....	9
Permanent / Minimum-Maximum measuring .....	9
Add / Subtract .....	9
Area .....	10
Volume .....	11
Pythagoras (2-point) .....	12
Pythagoras (3-point) .....	12
Pythagoras (partial height) .....	13
Stake out .....	14
Smart Horizontal Mode .....	15
Height tracking .....	15

Memory (20 last displays) .....	16
Delete Memory .....	16
<b>Calibration</b> .....	16
Calibration of tilt sensor (Tilt Calibration) .....	16
<b>Technical Data</b> .....	18
<b>Message Codes</b> .....	18
<b>Care</b> .....	19
<b>Service - United States</b> .....	19

## EN General Safety Instructions

### WARNING

Read all safety warnings and instructions. Before using the appliance, read these safety instructions, the appliance's operator's manual (found on the enclosed CD) and all labels on the appliance.

- Do not allow persons unfamiliar with the appliance, these safety instructions, and the appliance's operator's manual to operate the appliance.

This appliance can be dangerous in the hands of untrained users.

- Do not overreach. Keep proper footing and balance at all times.

This enables better control of the appliance in unexpected situations.

- Ensure adequate safeguards at the work site (e.g. surveying site when measuring on roads, construction sites, etc.)

### WARNING

The device produces visible laser beams, which are emitted from the appliance.

This device is a Class 2 laser product in accordance with IEC 60825-1:2007

- Laser light - Do not stare into beam or view directly with optical instruments.



Do not point laser light at others. Laser light can cause eye damage.

- Avoid dangerous environments.

Do not use in rain, snow, damp or wet locations. Do not use in the presence of explo-

sive atmospheres (gaseous fumes, dust or flammable materials).

- Maintain appliances. If damaged, have the appliance repaired before use.

Accidents may be caused by poorly maintained appliances.

- Use appliance only with specifically designated accessories.

Use of any other accessories may create a risk of injury.

- This tool is designed to be powered by 2-AAA batteries properly inserted into the tool.

Do not attempt to use with any other voltage or power supply.

- Do not leave batteries within the reach of children.

- Do not mix new and used batteries.

- Do not mix brands (or types within brands) of batteries.

- Do not mix rechargeable and non-rechargeable batteries.

- Install batteries according to polarity (+ / -) diagrams.

- Properly dispose of used batteries immediately.

- Do not incinerate or dismantle batteries.

- Under abusive conditions, liquid may be ejected from the battery, avoid contact. If contact accidentally occurs, flush with water. If liquid contacts eyes, additionally seek medical help.

Liquid ejected from the battery may cause irritation or burns.

- Keep hands away from all moving parts.

- Watch out for erroneous measurements if the appliance is defective or if it has been dropped, misused or modified.

- Carry out periodic test measurements.

Particularly after the appliance has been subject to abnormal use, and before, during and after important measurements.

- Do not dispose of appliance or batteries together with household waste material!

Appliance and batteries that have reached the end of their life must be collected separately and returned to an environmentally compatible recycling facility.

- Have your appliance serviced by a qualified repair person using only identical replacement parts.

This will ensure that the safety of the appliance is maintained.

- Maintain labels and nameplates.

These carry important information. If unreadable or missing, contact a MILWAUKEE service facility for a free replacement.

- The device conforms to the most stringent requirements of the relevant electromagnetic compatibility (EMC) standards and regulations.

Yet, the possibility of causing interference in other devices cannot be totally excluded.

## Instrument Set-up

### Introduction



The safety instructions and the user manual should be read through carefully before the product is used for the first time.



The person responsible for the product must ensure that all users understand these directions and adhere to them.

The symbols used have the following meanings:



#### **WARNING**

Indicates a potentially hazardous situation or an unintended use which, if not avoided, will result in death or serious injury.



#### **CAUTION**

Indicates a potentially hazardous situation or an unintended use which, if not avoided, may result in minor injury and/or appreciable material, financial and environmental damage.



Important paragraphs which must be adhered to in practice as they enable the product to be used in a technically correct and efficient manner.

### Overview

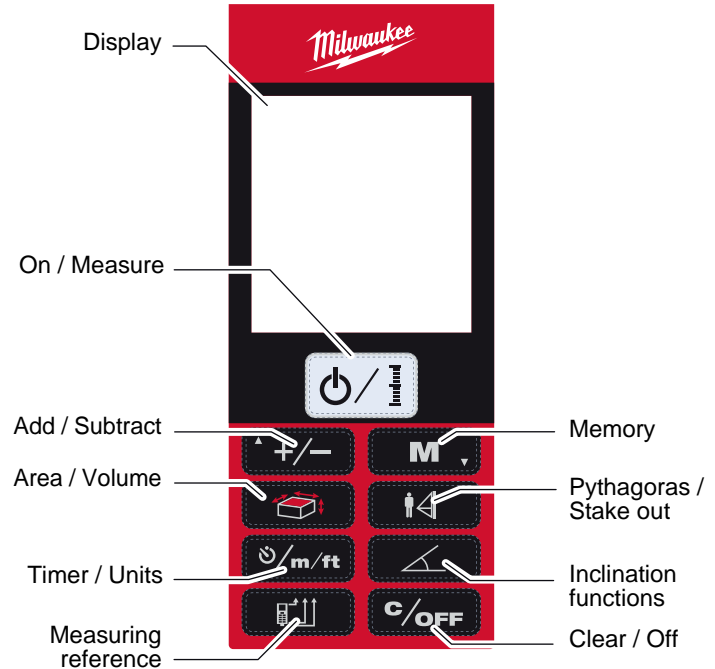

# EN Instrument Set-up

## Display

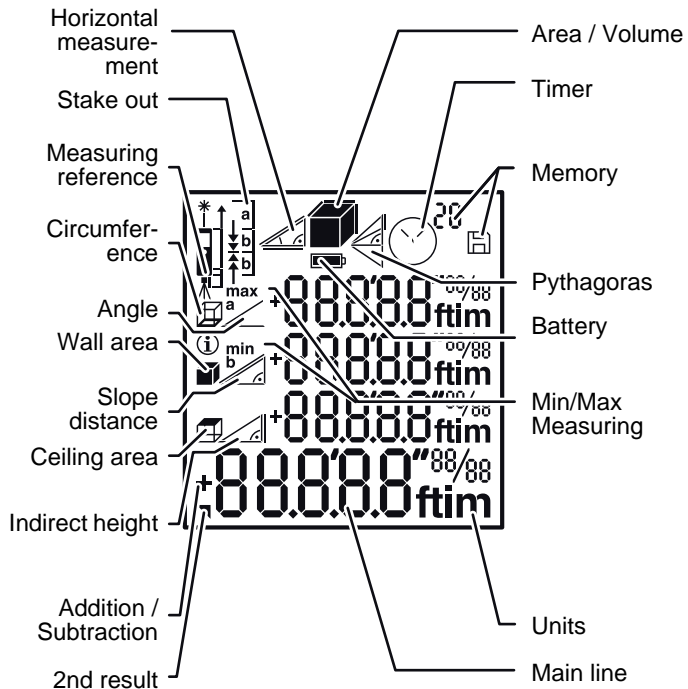

## Insert batteries

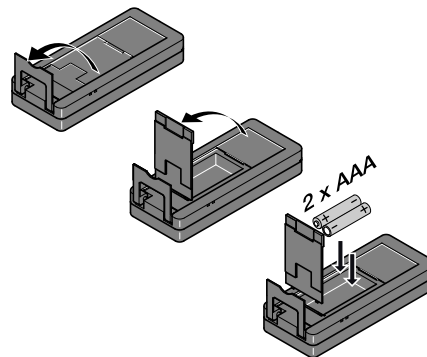

**i** To ensure a reliable use, do not use zinc-carbon batteries. Change batteries when battery symbol is flashing.

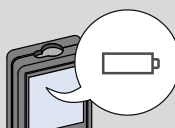

## Instrument Set-up

### Labeling

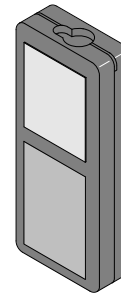
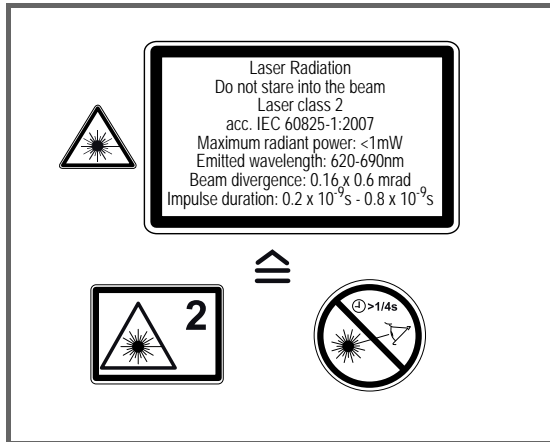

Subject to change (drawings, descriptions and technical data) without prior notice.

### Switching ON/OFF

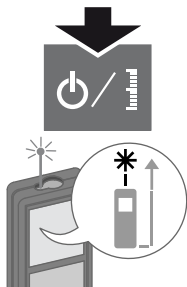

**i** Press ON button 2 sec to start continuous laser mode. If no key is pressed for 180 sec, the device switches off automatically.

### Clear



### Message Codes

If the info icon appears with a number, observe the instructions in section "Message Codes". Example:



### Beep ON/OFF

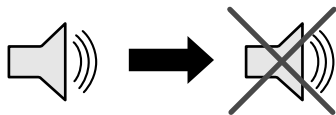
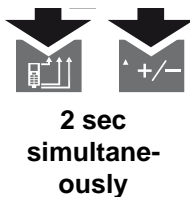

### Illumination ON/OFF

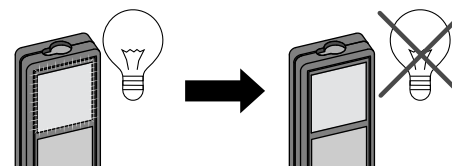
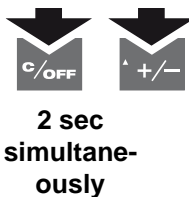

## Operations

### Adjusting measuring reference / tripod

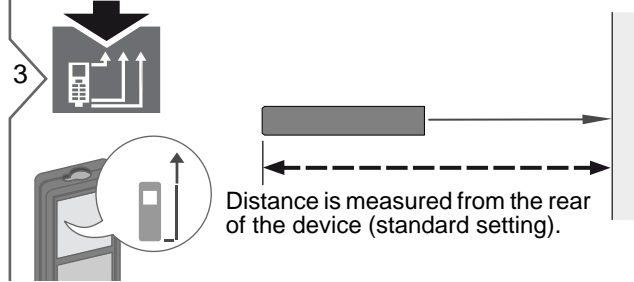
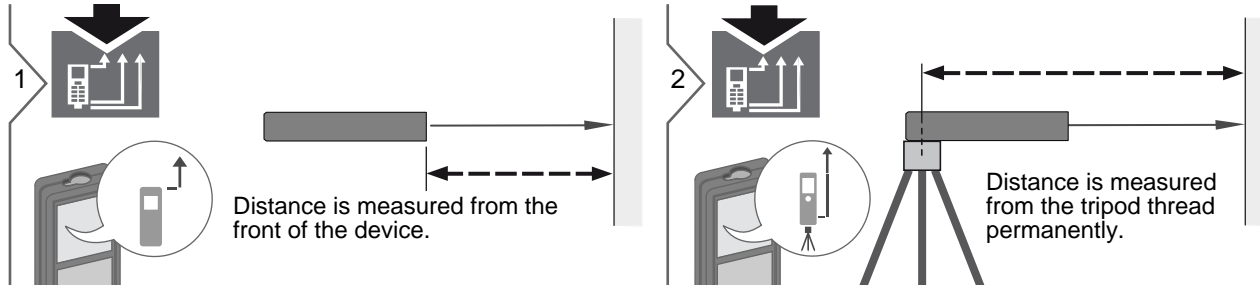

### Multifunctional endpiece

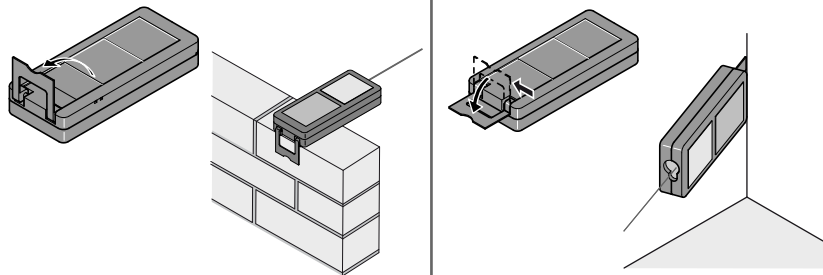

**i** The orientation of the endpiece is automatically detected and the zero point is accordingly adjusted.

### Distance unit setting



2 sec

Switch between the following units:

0.000 m	0.00 ft
0.0000 m	0'00" 1/32
0.00 m	0.00 in
	0 in 1/32

### Tilt unit setting



2 sec  
simultaneously

Switch between the following units:

0.0 °
0.0 %

### Timer (automatic release)

1

2

Adjust delay of automatic release (max. 60 sec, standard setting 5 sec)

**i** Once the key is released with the laser activated, the remaining seconds until the measurement are displayed in a countdown. The delayed release is recommended for precise aiming e.g. at long distances. It avoids shaking of the device when pressing the measurement key.



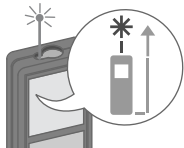

## Measuring Functions

### Measuring single distance

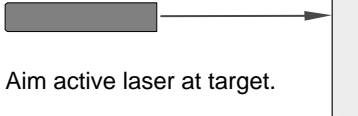

1  

2 Aim active laser at target. 

3   8.532 m

**i** Target surfaces: Measuring errors can occur when measuring to colourless liquids, glass, styrofoam or semi-permeable surfaces or when aiming at high gloss surfaces. Against dark surfaces the measuring time increases.

### Permanent / Minimum-Maximum measuring

1  2 sec 

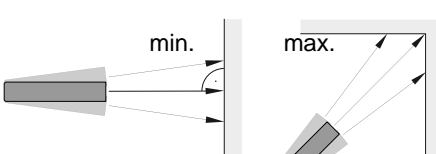

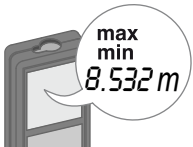
2  min. max.   
 Used to measure room diagonals (maximum values) or horizontal distance (minimum values)

3   max min 8.532 m

The minimum and maximum distance measured is displayed (min, max.). The last value measured is displayed in the main line.



**i** Stops permanent / minimum-maximum measuring.

### Add / Subtract

1   7.332 m

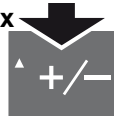
2  The next measurement is added to the previous one.

3x  The next measurement is subtracted from the previous one.

3   5.515 m 12.847 m

**i** The result is shown in the main line and the measured value above. This process can be repeated as required. The same process can be used for adding or subtracting areas or volumes.

# EN Measuring Functions

## Area

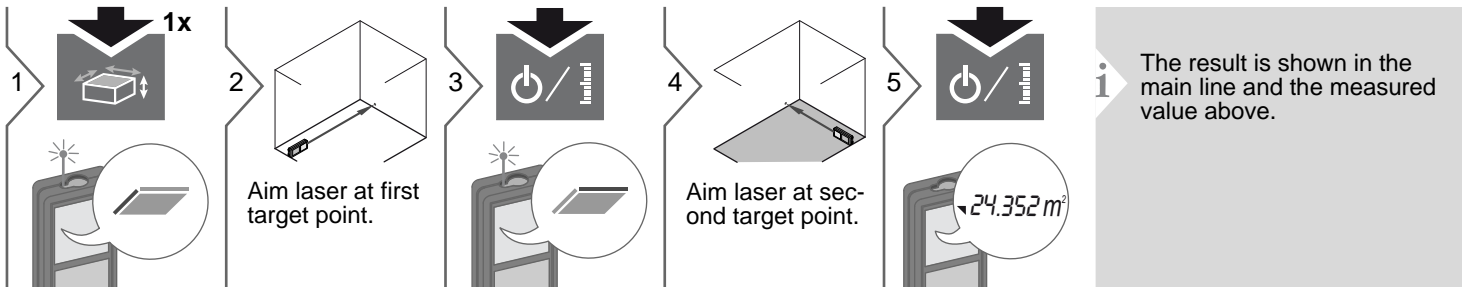

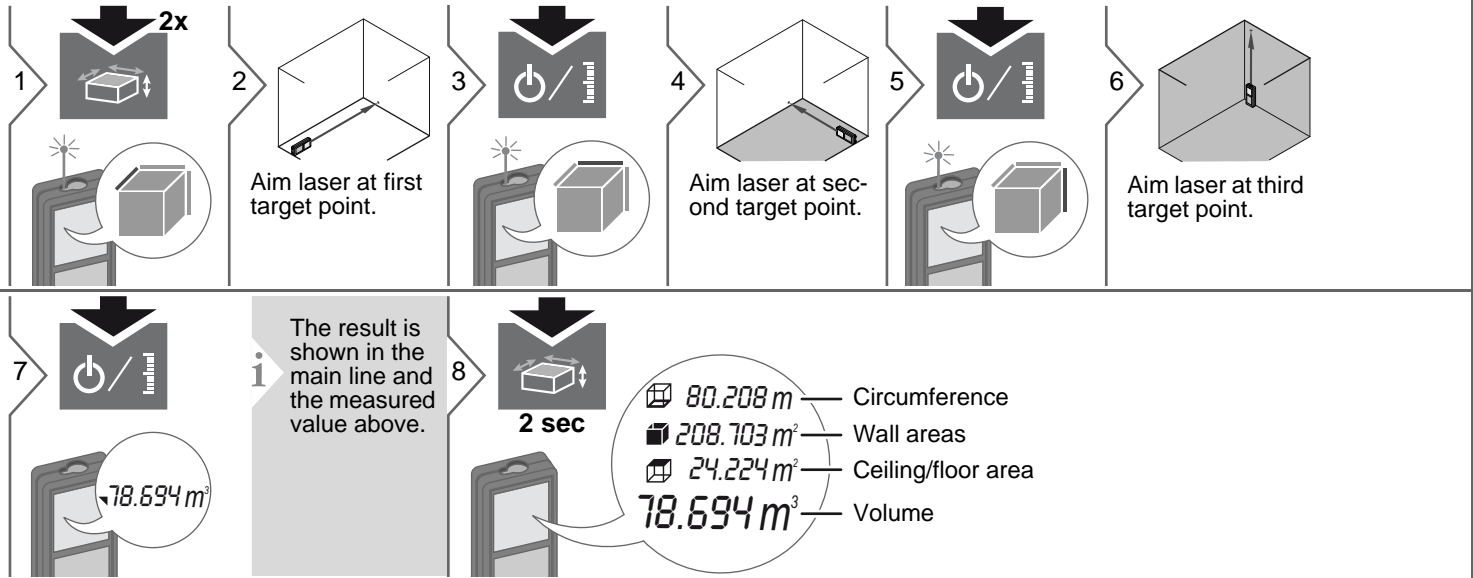

# Measuring Functions

## Volume



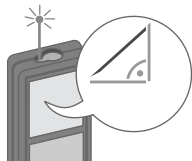

# EN Measuring Functions

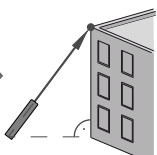

## Pythagoras (2-point)

1   

2  Aim laser at upper point.

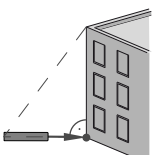

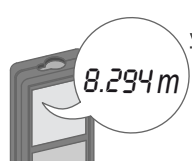
3   

4  Aim laser rectangular at lower point.

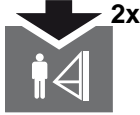
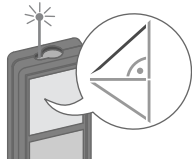

5    8.294 m

**i** Notice additional Pythagoras measurement information at the bottom of the next page.

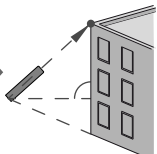

## Pythagoras (3-point)

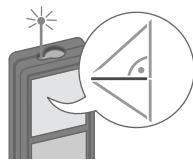
1   

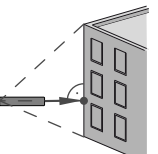

2  Aim laser at upper point.

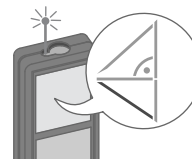
3   

4  Aim laser at rectangular point.

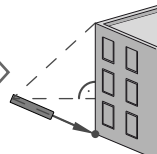
5   

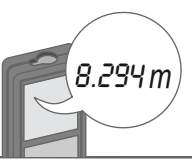
6  Aim laser at lower point.

7    8.294 m

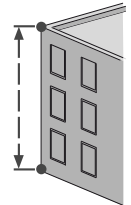

**i** Notice additional Pythagoras measurement information at the bottom of the next page.

## Measuring Functions

### Pythagoras (partial height)

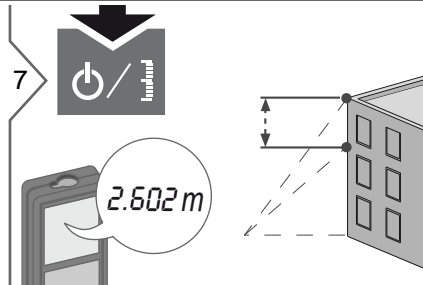
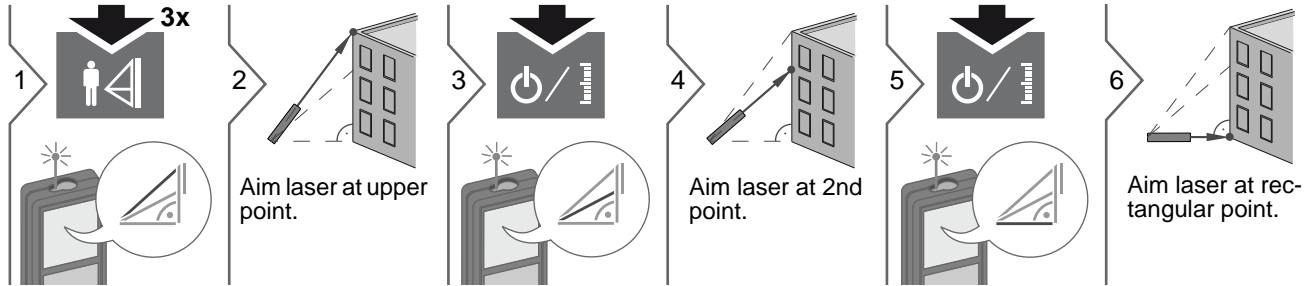

#### Pythagoras measurements:

- Pressing the measuring key for 2 sec in the function activates automatically Minimum or Maximum measurement.

i

# EN Measuring Functions

## Stake out

**i** Two different distances (a and b) can be entered to mark off defined measured lengths.

**2** Adjust value "a".  $1.012\text{ m}$

**3** Approve value "a".

**4** Adjust value "b".  $0.625\text{ m}$

**5** Approve value "b" and start measurement.

**6** Move device slowly along the stake-out line. The distance to the next stake out point is displayed.

$1.012\text{ m}$   
 $0.240\text{ m}$

0.240 m is missing up to next 1.012 m distance.

**i** When approaching a stake out point to less than 0.1 m the instrument starts to beep. The function can be stopped by pressing the CLEAR/OFF button.

# Measuring Functions

## Smart Horizontal Mode

1

2 Aim laser at target.

3

40.8°  $\alpha$   
 5.204 m  $x$   
 0.032 m  $y$   
 4.827 m  $z$

(up to 360° and a transverse tilt of  $\pm 10^\circ$ )

i Press key again to switch off horizontal measurement.

## Height tracking

i This function displays continuously the tracking height if the device is turned on a tripod. No 2nd distance measuring is needed as only the angle is automatically measured.

1

2 Aim laser at lower point.

3

4 Aim laser at upper points and angle/ height tracking starts automatically.

40.8°  $\alpha$   
 6.932 m  $x$   
 30.2°  $\beta$  = Tracking angle  
 9.827 m  $y$  = Tracking height

i

5

40.8°  $\alpha$   
 6.932 m  $x$   
 30.2°  $\beta$  = Tracking angle  
 9.827 m  $y$  = Tracking height

i The tracked height "y" is in 90° to the 1st aimed point "x".

6

i Stops Height tracking and displays last measurement.

## EN Measuring Functions

### Memory (20 last displays)

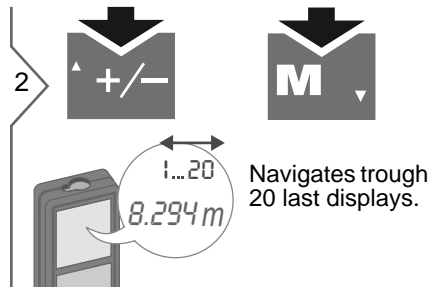
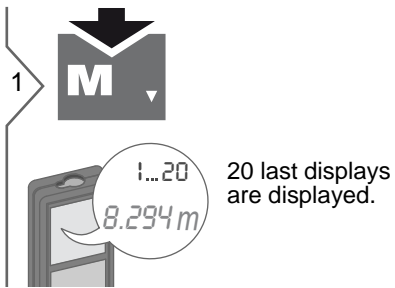



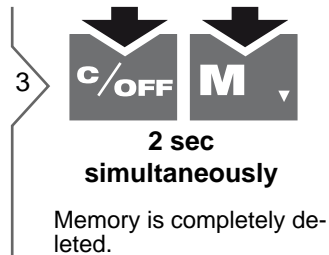







### Delete Memory

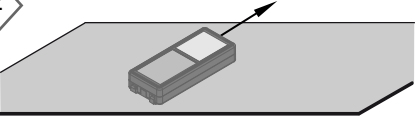

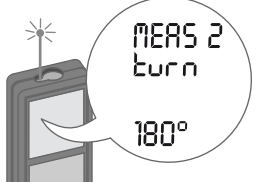
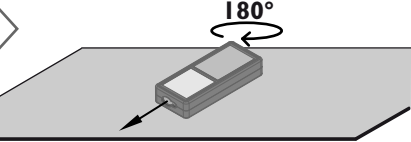

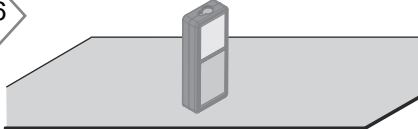
## Calibration

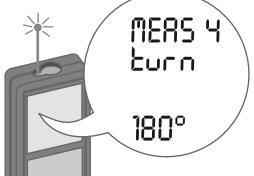
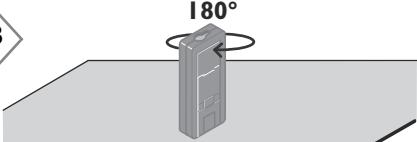
### Calibration of tilt sensor (Tilt Calibration)

<p>1</p>  <p>2 sec simultaneously</p> 	<p>2</p>  <p>Place device on absolutely flat surface.</p>	<p>3</p>  
<p>4</p>  <p>Turn the device horizontally by 180° and place it again on absolutely flat surface.</p>	<p>5</p>  	<p>6</p>  <p>Turn the device and place it again on absolutely flat surface.</p>
<p>7</p>  	<p>8</p>  <p>Turn the device horizontally by 180° and place it again on absolutely flat surface.</p>	<p>9</p>   <div data-bbox="1432 779 1600 1058" style="background-color: #e0e0e0; padding: 5px;"> <p><b>i</b> After 2 sec the device goes back to the normal mode.</p> </div>

Distance measurement	
Typical Measuring Tolerance*	± 1.5 mm / 0.06 in ***
Maximum Measuring Tolerance**	± 2.5 mm / 0.10 in ***
Range of target plate	80 m / 262 ft
Typical Range*	80 m / 262 ft
Range at unfavourable condition ****	60 m / 197 ft
Smallest unit displayed	0.1 mm / 1/32 in
Ø laser point at distances	6 / 30 / 50 mm (10 / 50 / 80 m)
Tilt measurement	
Measuring tolerance to laser beam*****	± 0.2°
Measuring tolerance to housing*****	± 0.2°
Range	360°
General	
Laser class	2
Laser type	635 nm, < 1 mW
Protection class	IP54 (dust- and splash water protected)
Autom. laser switch off	after 90 s
Autom. power switch-off	after 180 s
Battery durability (2 x AAA)	up to 5000 measurements
Dimension (H x D x W)	117 x 57 x 32 mm 4.6 x 2.4 x 1.3 in
Weight (with batteries)	0.14 kg / 4.938 oz
Temperature range:	
- Storage	-25 to 70 °C -13 to 158 °F
- Operation	-10 to 50 °C 14 to 122 °F

\* applies for 100 % target reflectivity (white painted wall), low background illumination, 25 °C  
 \*\* applies for 10 to 500 % target reflectivity, high background illumination, - 10 °C to + 50 °C  
 \*\*\* Tolerances apply from 0.05 m to 10 m with a confidence level of 95%. The maximum tolerance may deteriorate to 0.1 mm/m between 10 m to 30 m and to 0.2 mm/m for distances above 30 m  
 \*\*\*\* applies for 100 % target reflectivity, background illumination of approximately 30'000 lux  
 \*\*\*\*\* after user calibration. Additional angle related deviation of +/- 0.01° per degree up to +/-45° in each quadrant. Applies at room temperature. For the whole operating temperature range the maximum deviation increases by +/- 0.1°.

**i** For accurate indirect results, the use of a tripod is recommended. For accurate tilt measurements a transverse tilt should be avoided.

Functions	
Distance measuring	yes
Min/Max measuring	yes
Permanent measuring	yes
Stake-out	yes
Addition/Subtraction	yes
Area	yes
Volume	yes
Pythagoras	2-point, 3-point, partial height
Smart Horizontal Mode / Indirect height	yes
Height tracking	yes
Memory	20 displays
Beep	yes
Illuminated display	yes
Multifunctional endpiece	yes

## Message Codes

If the message **Error** does not disappear after switching on the device repeatedly, contact the dealer.

If the message **InFo** appears with a number, press the Clear button and observe the following instructions:

No.	Cause	Correction
156	Transverse tilt greater than 10°	Hold the instrument without any transverse tilt.
162	Calibration mistake	Make sure, the device is placed on a absolutely horizontal and flat surface. Repeat the calibration procedure. If the mistake still occurs, contact your dealer.
204	Calculation error	Perform measurement again.
252	Temperature too high	Let device cool down.
253	Temperature too low	Warm device up.
255	Received signal too weak, measuring time too long	Change target surface (e.g. white paper).
256	Received signal too high	Change target surface (e.g. white paper).
257	Too much background light	Shadow target area.
258	Measurement outside of measuring range	Correct range.
260	Laser beam interrupted	Repeat measurement.

## Care

- Clean the device with a damp, soft cloth.
- Never immerse the device in water.
- Never use aggressive cleaning agents or solvents.

## Service - United States

MILWAUKEE prides itself in producing a premium quality product that is Nothing But Heavy Duty®.

Your satisfaction with our products is very important to us!

If you encounter any problems with the operation of this tool, or you would like to locate the factory Service/Sales Support Branch or authorized service station nearest you, please call...

Additionally, we have a nationwide network of authorized Distributors ready to assist you with your tool and accessory needs.

Check your "Yellow Pages" phone directory under "Tools-Electric" for the names & addresses of those nearest you or see the 'Where To Buy' section of our website.

### 1-800-SAWDUST

(1.800.729.3878)

Monday-Friday

7:00 AM - 6:30 PM

Central Time

or visit our website at

**[www.milwaukeetool.com](http://www.milwaukeetool.com)**

For service information, use the 'Service Center Search' icon found in the 'Parts & Service' section.

## Contact our Corporate After Sales Service Technical Support about ...

- Technical Questions
- Service/Repair Questions
- Warranty

call: 1-800-SAWDUST

fax: 1.800.638.9582

email:

[metproductsupport@milwaukeetool.com](mailto:metproductsupport@milwaukeetool.com)

## Register your tool online at [www.milwaukeetool.com](http://www.milwaukeetool.com) and...

- receive important notifications regarding your purchase
- ensure that your tool is protected under the warranty
- become a Heavy Duty club member