



Catalog Number: UC7444-RL
Item Description: 20A 8T RL TS PROV OU
UPC Code: 784572144880

Brand Name: Milbank
Type: Ringless Meter Socket
Application: Meter Socket
Standard: UL Listed
Voltage Rating: 600 Volts Alternating Current
Amperage Rating: 20 Continuous Ampere
Phase: 3 Phase
Frequency Rating: 60 Hertz
Number Of Cutouts: 0
Cable Entry: Overhead and Underground
Terminal: Single Mechanical Line Side and Single Mechanical Load Side
Mounting: Surface Mount
Enclosure: Type 3R, G90 Galvanized Steel with Powder Coat Finish



Additional Specifications: Number of Jaws:8 Terminal
Hub Opening and Closing Plates:Small Hub Opening
Hub Opening and Closing Plates:Small Hub Opening
Hub Opening and Closing Plates:Small Hub Opening
Hub Opening and Closing Plates:Small Hub Opening
Hub Opening and Closing Plates:Small Hub Opening

Utility requirements may vary. Always consult the serving utility for their requirements prior to ordering or installing this equipment. This product must always be installed by a licensed electrician. Installation of this equipment may require local electrical inspector approval.

FEATURE TABLE		
ITEM	QTY	DESCRIPTION
A	4	STD. MNTG. EMBOSS
B	1	¼, ½ CONC. K.O.
C	3	¼, ½, ¾, 1, 1¼ CONC. K.O.
D	3	½, ¾, 1, 1¼ CONC. K.O.

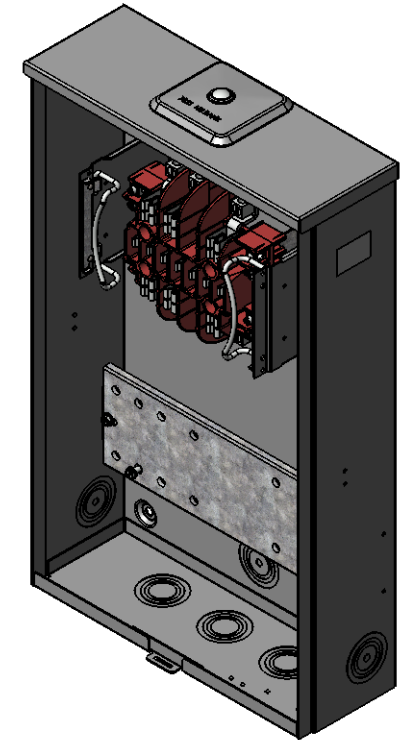
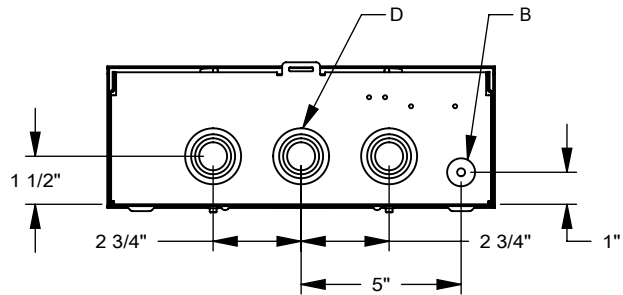
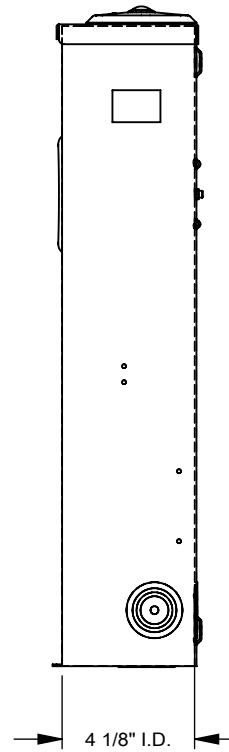
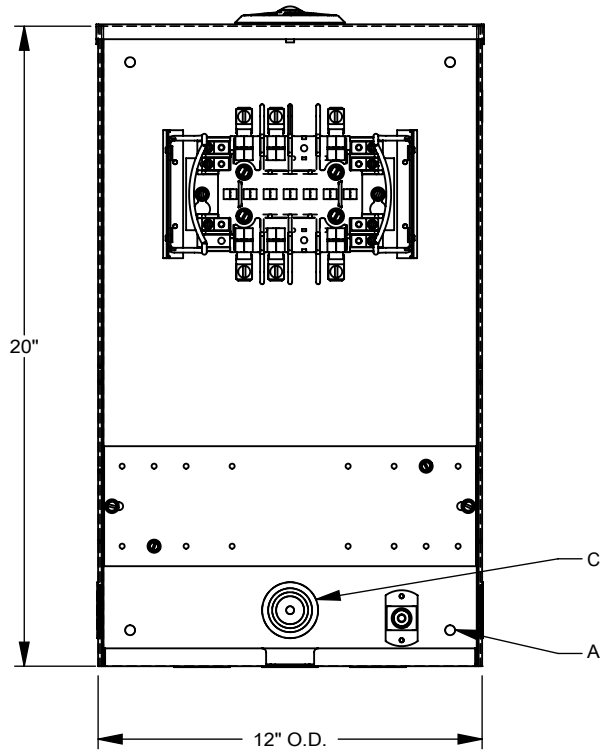

Version:

1

All dimensions are +/- 1/16".
Drawing views are not to scale.

Utility requirements for this equipment may vary. Always consult the serving utility for their requirements prior to ordering or installing this equipment. This product must be installed by a licensed electrician. Installation of this equipment may require local electrical inspector approval.