



2013 – 2014 PRODUCT CATALOG



INDUSTRIAL PLUGS AND RECEPTACLES

SWITCH RATED PLUGS & RECEPTACLES • HAZARDOUS DUTY PLUGS & RECEPTACLES
MULTIPIN CONNECTORS • HIGH AMPERAGE CONNECTORS • CUSTOM POWER DISTRIBUTION PANELS

meltric.com

 **MELTRIC**
CORPORATION

This document is not contractual and we cannot be held responsible for any inadvertent error that may appear in this catalog. We also reserve our right to alter specifications without any prior notice in the continuance of improving our products.

2013 –2014 PRODUCT CATALOG



Introduction

Meltric Overview	pg 3
Product Features & Benefits	pg 5
Product Summary & Selection Guide	pg 9



Switch Rated Plugs & Receptacles

Decontactor™ Series – The Main Differences	pg 17
Decontactor™ Selection Guide	pg 21
DSN	
Type 4X rated, poly casings. From 20 – 60A (1/2 – 20 hp)	pg 23
DS	
Type 3R rated, metal or poly casings. From 20A – 200A (1/2 – 25 hp)	pg 35
DB	
IP67 rated, metal casings. From 30 – 100A (1 1/2 – 60 hp)	pg 53



Hazardous Duty Plugs & Receptacles

Hazardous Duty Selection Guide	pg 67
DXN	
CSA and ATEX rated, poly casings. From 20 – 60A	pg 69
DX	
ATEX rated, metallic casings. From 20A – 100A	pg 81
Multipin	
ATEX rated, 25 to 37 pins, 10A	pg 91
Single Pole	
ATEX rated, up to 680A, 1000VAC	pg 95



Multipin Plugs & Receptacles

Multipin Plugs & Receptacles	
4 – 37 pin connectors in poly and metal. From 2 – 150A	pg 97



High Ampacity Plugs & Receptacles

PF/PFQ High Amperage Connectors	
IP66+IP67 rated, metal construction. From 300A – 600A	pg 127
SP Connectors	
Single pole, connectors up to 600A	pg 133
CS1000	
Single pole, connectors up to 400A	pg 137





Standard Duty Plugs & Receptacles

DR Plugs & Receptacles

Type 3R rated, poly or metal casings. From 30 – 250A pg 141

PN Connectors

IP66+IP67 rated or IP54 rated, poly or metal. From 20 – 30A pg 157

DSDC Plugs & Receptacles

DC current rated, poly or metal casings. Up to 750 VDC pg 167

Specialty Products

Custom Power Distribution Solutions

Built specifically to meet customer needs pg 172

Integral Circuit Protection Wall Boxes

Premounted receptacles wired to circuit protection 20A-60A pg 179

Safety Switch/Receptacle Combinations

Switch-rated receptacles mounted to single throw, fusible safety switch pg 185

WS – Welding Connectors

Single pole connectors (max 50 VAC) pg 187

LC – Battery Connectors

For battery charging and interconnect from 75A to 200A pg 188

Adapter Plates

For converting existing receptacles to Meltric pg 189

Cord Grips

..... pg 193

Voltage/Phase Rotation Meter Assemblies

..... pg 195



Reference

Accessories & Options

..... pg 198

Technical Information

Chemical and mechanical resistance, environmental ratings, electrical testing and ratings information, keying positions, and more pg 208

Index

Suffix Index, Parts Index and Literature order form pg 224



Meltric Corporation

The best in industrial wiring devices

Safety
Reliability
Service
Value

At Meltric Corporation, our only business is electrical plugs and receptacles. We are focused on providing our customers with the best overall value by offering the safest, highest quality and most reliable plugs and receptacles, and by backing them with outstanding service and support.



Product Technology & Safety

The technology behind Meltric's products was developed specifically to address the shortcomings and safety hazards common with pin & sleeve type plugs and receptacles. In 1952, following the observation of an accident with a pin and sleeve device, Gilles Marechal devised the concept of combining the advantages of silver-nickel butt contacts and the load making and breaking capabilities of a switch with the convenience of a plug and receptacle. Shortly thereafter, the first of these products was born. Meltric licensed this technology in the early 1980's and has been supplying its products to North American customers ever since.

Value

With their unique features and capabilities, Meltric products provide users with a safer and more reliable product than competitive pin and sleeve devices. Meltric's butt style contacts provide longer operating lives, optional integral pilot contacts reduce the need for additional connectors and our switch rated Decontactors can eliminate the need for auxiliary interlocks and disconnect switches, helping users reduce equipment costs. These advantages, together with competitive pricing, short lead times, and 5-year warranty on electrical contacts, make Meltric's products the best overall value in the plug & receptacle/connector market.





Service & Support

Meltric backs its superior products with outstanding service and support. A network of over 150 sales associates and over 2000 distributor locations throughout the US, Canada and Mexico make access to our product easy.

Meltric's Customer Service group is trained to answer most technical questions on the spot and is located at our manufacturing facility in order to help streamline the order fulfillment process. Our engineering team stands ready to provide both application support and custom designed products incorporating Meltric and third party components into power distribution products tailored to meet your needs. Friendly and personal assistance is only a toll free call away at (800) 433-7642.

Many of Meltric's products are designed in a modular fashion, which permits cost effective stocking of components and quick final assembly of the product. Together with efficient order handling by Customer Service, this helps Meltric to provide the shortest lead times in the industry.

Quality

Quality is not just an inspection function at Meltric. Quality starts with intelligent designs, robust materials, clear procedures, process measurement and controls and effective communications. It is completed by the care, commitment and involvement of each of our employees.

Meltric is dedicated to the continuous improvement of all its critical production and support processes and is ISO 9001:2008 certified. Meltric designs and manufactures its products to exceed the requirements of applicable UL, CSA and IEC standards. In addition, Meltric manufactures its products in accordance with BECMA (Butt contact Electrical Connectors Manufacturers' Association) quality and standardization requirements to ensure proper connection and performance with appropriately rated butt contact connectors produced by other manufacturers.

Worldwide Availability

Marechal Technology products are manufactured in North America, Europe, South Africa and Australia. Meltric supplies product directly from its factory in Franklin, Wisconsin to customers in the United States, Canada and Mexico. For customers outside of North America, product is provided through other Marechal Electric Group companies and sales agents.

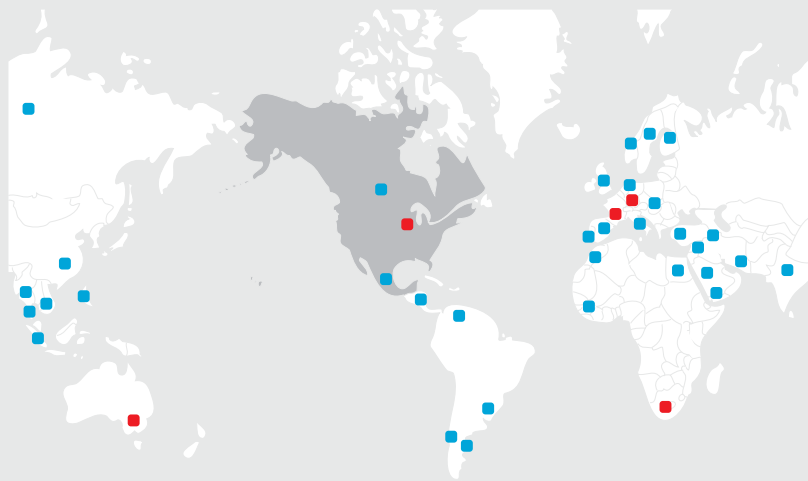

MARECHAL ELECTRIC GROUP
● **FACTORY LOCATIONS**
● **SALES OFFICES**

Meltric Product Features...

Spring-Loaded Butt Contacts

Meltric products feature spring-loaded butt contacts similar to those used in contactors and switchgear. These contacts have numerous advantages, which help improve electrical performance and user safety relative to pin and sleeve contacts or the arcuate contacts used in twist-type devices.



Butt-style contacts ensure a very positive and consistent connection. The spring loading of these contacts, which is accomplished with coil springs, provides a desirably high contact force that remains constant over thousands of operations. In addition, it automatically compensates for any wear and/or deviations in contact length resulting from manufacturing tolerances.

This is a critical point, as contact force is a key determinant of the quality of a contact. As the accompanying chart demonstrates, contact resistance increases as contact force is reduced. Higher contact resistance generates more heat and oxidation, both of which contribute to the deterioration of the contact. This is a problem with pin and sleeve and arcuate type contacts because their contact force varies with manufacturing tolerances and is reduced due to wear that occurs with normal use.

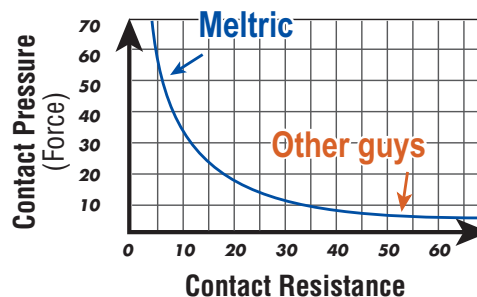

Meltric contacts close with a self-cleaning wiping action. When the contacts initially mate, they are slightly offset. In completing the connection, the plug contacts are rotated across the receptacle contacts, helping to remove deposits from the contact surfaces.

In conjunction with the spring-loaded casings used on many Meltric products, the spring-loaded contacts ensure a quick breaking of the connection that is independent of the motion of the user. By contrast, the disconnection speed of pin and sleeve and twist-type devices is dependent upon the motion of the user.

...and Benefits

Silver-Nickel Contact Material

Meltric uses solid silver-nickel (85%/15%) contacts. The silver-nickel material has significant advantages over the brass contacts commonly used on competitive devices.

Silver has very low initial contact resistance and is not negatively affected by oxidation. This helps to give it excellent electrical properties that are maintained even at high temperatures and after tarnishing. Nickel is a much harder material and contributes excellent mechanical properties. The combination of silver and nickel results in a contact material that has both superior electrical capabilities and excellent resistance to wear. Silver-nickel only welds at extremely high pressure and temperature, and thus, also withstands arcs very well. These features make silver-nickel a commonly used contact material by switchgear manufacturers.

MATERIAL	CONTACT RESISTANCE	
	NEW	OXIDIZED
SILVER	6 $\mu\Omega$	25 $\mu\Omega$
SILVER-NICKEL	23 $\mu\Omega$	60 $\mu\Omega$
COPPER	29 $\mu\Omega$	400 $\mu\Omega$
BRASS	370 $\mu\Omega$	1400 $\mu\Omega$



By contrast, the brass material used in most competitive plug and receptacles has much higher initial contact resistance and is negatively affected by oxidation. In an oxidized state, the contact resistance of brass is more than 20 times higher than that of silver-nickel. In addition, brass is a soft material that wears rapidly. In use, brass pin and sleeve and arcuate contacts suffer from the combined effects of the limitations of the material and the design. As oxidation and wear induced reductions in contact force occur, contact resistance increases. This increases operating temperature, which causes further oxidation and wear, perpetuating a vicious cycle of degradation. Brass is not arc resistant and is not suitable for making and breaking under load.

Dead Front Construction

Most Meltric products feature dead front construction, which greatly enhances safety by eliminating any unintended access to live parts. On most Meltric products, the dead front is accomplished with a safety shutter that can be opened only by an appropriate mating plug. The live receptacle contacts can only be accessed by the plug, after its insertion into the receptacle. The design of the product also ensures that the plug contacts are dead before the user can remove the plug from the receptacle.

By contrast, pin and sleeve and twist-type devices do not have a safety shutter. Access to live receptacle contacts is possible, and on some devices the plug contacts may be live and accessible when the plug is being removed.



Meltric Product Features...



Push-Button Circuit Disconnection

To disconnect most Meltric products, the user simply needs to depress the pawl. This causes the circuit to be disconnected and the plug to be ejected to its rest (off) position in the receptacle. If desired, the user can then remove the plug from the receptacle by rotating it slightly and then withdrawing it. This mode of operation ensures that it is only possible to remove the plug after its contacts have been deenergized.

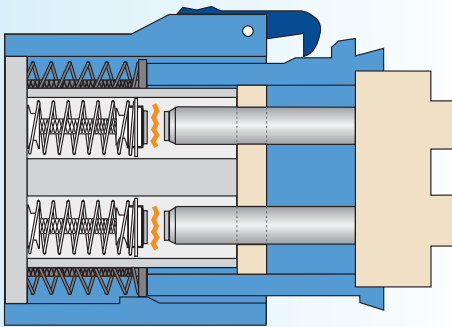

Enclosed Arc Chambers

The contacts on most Meltric products make and break within enclosed arc chambers. This ensures that the arcing which normally occurs during the making and breaking of the contacts is contained inside the device. This greatly enhances safety and avoids potential injury to users and/or harm to the outside environment.

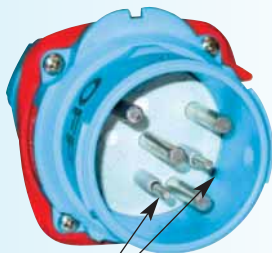

Auxiliary/Pilot Contacts

Optional Auxiliary/Pilot Contacts

Many Meltric products are available with optional auxiliary/pilot contacts. These integral pilot contacts allow users the convenience and flexibility of controlling auxiliary equipment, monitoring parameters (such as motor temperature), and/or communicating alarms through the same plug and receptacle used to supply power to the equipment. Because the pilot contacts are integral, they also facilitate the rapid change-out or reconfiguration of equipment by eliminating the need for hard wiring or multiple plug connections.

Automatic Watertightness

On most pin and sleeve devices, an additional plastic ring must be tightened in order to ensure the achievement of rated watertightness. Users frequently fail to do this, resulting in leakage. Meltric solves this problem with its DS and DSN Decontactor™ Series plugs and receptacles, which achieve their rated watertightness of up to NEMA 4X simply by mating the plug with the receptacle. After the removal of the plug, rated watertightness is maintained for the receptacle by simply closing the lid.



...and Benefits

Spring-Assisted Terminals

The loosening of terminal screws is a common cause for failure on standard plugs and receptacles. Meltric provides a more permanent and secure connection with its unique and patented spring-assisted terminal design.

As the terminal screw is tightened against the conductor, the associated pressure expands the split terminal body, causing a spring ring surrounding the terminal to deform into an elliptical shape. The natural tendency for the spring ring to return to its original size and shape ensures that a constant pressure is maintained on the conductor. This allows the terminal to effectively compensate for strand settlement and conductor yield, due to cold flow of the material, and provides superior resistance to vibration, shock and thermal cycling.

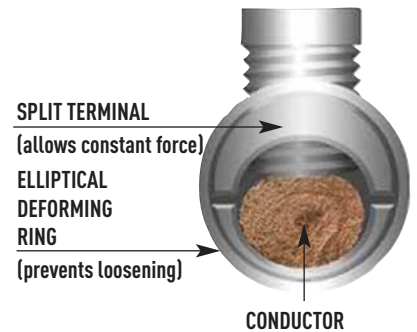

Lockout-Tagout Capability

Most Meltric plugs and receptacles facilitate compliance with OSHA lockout-tagout requirements. Only a lock or lockout hasp and tag are needed to ensure that the plug is properly locked out and tagged out. Additional mechanisms are not required because the lockout provision is integral to the device – it is always available when you need it. On most models the lockout provision is a simple 5/16" hole in the plug shroud that facilitates the insertion of a typical padlock or lockout hasp which prevents the plug from being inserted into a receptacle.



An optional provision for locking out Meltric receptacles is also available. In most cases this is accomplished via a specially machined hole in the receptacle casing which allows insertion of a padlock to secure the receptacle lid in a closed position. This same optional provision can be used to prevent removal of the plug if desired.







By comparison, in order to lockout most competitive pin and sleeve type plugs, an additional third-party 'lockout shield' or 'plug cap' is required. These devices can be expensive and are often times lost, broken, or not available when you need them.

Modular Construction

Due to the robust construction of Meltric devices, the need to replace worn parts is rare. However, should they be required, parts are readily available and reasonably priced. The modular construction of most Meltric devices enables easy replacement of parts in the field.





Meltric Product Summary and Selection Guide

	Model	Amp Rating	Maximum Voltage Rating		Environmental Ratings		Available Casing Materials			Maximum Number of Contacts	
			VAC	VDC	Type	IP	Poly	Metal	SS	Main	Auxiliary
Decontactors	 DSN20	20	480	-	4X	66 + 67	Poly	-	-	3P+N+G	-
	DSN30	30	600	-	4X	66 + 67	Poly	-	-	3P+N+G	2
	DSN60	60	600	-	4X	66 + 67	Poly	-	-	3P+N+G	4
	DS20	20	600	-	3R	54/55	Poly	-	SS	3P+N+G	2
	DS30	30	600	-	3R	54/55	Poly	-	SS	3P+N+G	4
	 DS60	60	600	-	3R	54/55	Poly	Metal	-	3P+N+G	3
	DS100C	100	600	-	3R	54/55	Poly	Metal	-	3P+N+G	3
	DS100	100	600	-	3R	54/55	Poly	Metal	-	3P+N+G	6
	DS200	200	480	-	3R	54/55	-	Metal	-	3P+N+G	5
	 DB30	30	600	-	-	67	-	Metal	-	3P+N+G	2
DB60	60	600	-	-	67	-	Metal	-	3P+N+G	2	
DB100	100	600	-	-	67	-	Metal	-	3P+N+G	4	
Hazardous Location	 DXN20	20	480	-	-	66 + 67	Poly	-	-	3P+N+G	-
	DXN30	30	600	-	-	66 + 67	Poly	-	-	3P+N+G	2
	DXN60	60	600	-	-	66 + 67	Poly	-	-	3P+N+G	2
	DX20	20	600	-	-	65	-	Metal	-	3P+N+G	-
	 DX30	30	600	-	-	65	-	Metal	-	3P+N+G	-
	DX60	60	600	-	-	65	-	Metal	-	3P+N+G	-
	DX100	100	600	-	-	65	-	Metal	-	3P+N+G	-
	 DXN25c	10	440	-	-	66 + 67	-	Metal	-	25	-
	DXN37c	10	220	-	-	66 + 67	-	Metal	-	37	-
	PXN12c	10	220	-	-	65 + 66	-	Metal	-	12	-
SPeX	680	1000	-	-	65 + 66	Poly	-	-	1P	-	
Standard	 DR30	30	600	-	3R	54/55	Poly	-	-	3P+N+G	2
	DR50	50	600	-	3R	54/55	Poly	-	-	3P+N+G	4
	DR100	100	600	-	3R	54/55	Poly	Metal	-	3P+N+G	3
	DR150	150	600	-	3R	54/55	Poly	Metal	-	3P+N+G	6
	DR250	250	600	-	3R	54/55	-	Metal	-	3P+N+G	5

Model	Current Interruption Rating*	Horsepower Ratings (see catalog section for other voltages)			Main Contacts Wire Size Capacity		Terminal Type
		240V - 3Ø	480V - 3Ø	600V - 3Ø	Min	Max	
DSN20	Switch Rated	2 hp	5 hp	-	14 AWG	12 AWG	Screw
DSN30	Switch Rated	5 hp	10 hp	15 hp	14 AWG	8 AWG	Screw
DSN60	Switch Rated	7 1/2 hp	20 hp	20 hp	12 AWG	4 AWG	Screw
DS20	Switch Rated	3 hp	5 hp	7 1/2 hp	14 AWG	8 AWG	Screw
DS30	Switch Rated	3 hp	10 hp	10 hp	14 AWG	6 AWG	Screw
DS60	Switch Rated	7 1/2 hp	20 hp	25 hp	10 AWG	2 AWG	Screw
DS100C	Switch Rated	7 1/2 hp	20 hp	25 hp	10 AWG	2 AWG	Screw
DS100	Switch Rated	-	-	-	8 AWG	2/0 AWG	Screw
DS200	Switch Rated	-	-	-	4 AWG	4/0 AWG	Screw
DB30	Switch Rated	7 1/2 hp	10 hp	10 hp	14 AWG	8 AWG	Screw
DB60	Switch Rated	15 hp	30 hp	30 hp	8 AWG	3 AWG	Screw
DB100	Switch Rated	30 hp	60 hp	60 hp	4 AWG	2/0 AWG	Screw
DXN20	Current Interrupting	-	-	-	16 AWG	10 AWG	Screw
DXN30	Current Interrupting	-	-	-	12 AWG	6 AWG	Screw
DXN60	Current Interrupting	-	-	-	10 AWG	4 AWG	Screw
DX20	Current Interrupting	-	-	-	14 AWG	6 AWG	Screw
DX30	Current Interrupting	-	-	-	14 AWG	6 AWG	Screw
DX60	Current Interrupting	-	-	-	8 AWG	2 AWG	Screw
DX100	Current Interrupting	-	-	-	4 AWG	2 AWG	Screw
DXN25c	Non-Current Interrupting	-	-	-	16 AWG	14 AWG	Solder
DXN37c	Non-Current Interrupting	-	-	-	16 AWG	14 AWG	Solder
PXN12c	Non-Current Interrupting	-	-	-	16 AWG	14 AWG	Solder
SPeX	Non-Current Interrupting	-	-	-	2/0 AWG	750 MCM	Lug
DR30	Non-Current Interrupting	-	-	-	14 AWG	8 AWG	Screw
DR50	Current Interrupting1	-	-	-	14 AWG	6 AWG	Screw
DR100	Current Interrupting	-	-	-	10 AWG	2 AWG	Screw
DR150	Current Interrupting1	-	-	-	8 AWG	2/0 AWG	Screw
DR250	Non-Current Interrupting	-	-	-	4 AWG	4/0 AWG	Screw

* 'Switch Rated' and 'Current Interrupting' ratings apply to alternating current only

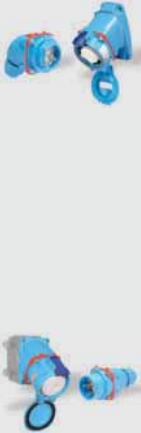
Meltric Product Summary and Selection Guide



	Model	Amp Rating	Maximum Voltage Rating		Environmental Ratings		Available Casing Materials			Maximum Number of Contacts	
			VAC	VDC	Type	IP	Poly	Metal	SS	Main	Auxiliary
Standard 	PN	15	600	-	-	55 or 66 + 67*	Poly	Metal	SS	3P+N+G	-
	PN	20	480	-	-	55 or 66 + 67*	Poly	Metal	SS	3P+N+G	-
	PN	30	600	-	-	55 or 66 + 67*	Poly	Metal	SS	3P+N+G	-
	PNHT	15	600	-	-	44	-	Metal	-	3P+N+G	-
	PNHT	20	480	-	-	44	-	Metal	-	3P+N+G	-
	PNHT	30	600	-	-	44	-	Metal	-	3P+N+G	-
	DSDC1	20	-	250	3R	54/55	Poly	-	-	2P+G	0
	DSDC1	15	-	600	3R	54/55	Poly	-	-	2P+G	0
	DSDC1	10	-	750	3R	54/55	Poly	-	-	2P+G	0
	DSDC3	30	-	250	3R	54/55	Poly	-	-	2P+G	0
	DSDC3	30	-	600	3R	54/55	Poly	-	-	2P+G	0
	DSDC3	20	-	750	3R	54/55	Poly	-	-	2P+G	0
	DSDC6	60	-	250	3R	54/55	Poly	Metal	-	2P+G	0
	DSDC6	50	-	600	3R	54/55	Poly	Metal	-	2P+G	0
	DSDC6	30	-	750	3R	54/55	Poly	Metal	-	2P+G	0
DSDC9	100	-	250	3R	54/55	Poly	Metal	-	2P+G	0	
DSDC9	60	-	600	3R	54/55	Poly	Metal	-	2P+G	0	
DSDC2	200	-	250	3R	54/55	-	Metal	-	2P+G	0	
DSDC2	100	-	600	3R	54/55	-	Metal	-	2P+G	0	
Multipin 	PN12c	5	600	-	-	66 + 67*	Poly	Metal	SS	11P+G	-
	PN12c	7.5	600	-	-	66 + 67*	Poly	Metal	SS	11P+G	-
	DSN24c	2	480	130	-	66 + 67	Poly	-	-	24	-
	DSN24c	7.5	480	130	-	66 + 67	Poly	-	-	24	-
	DS24c	2	250	130	-	-	-	-	SS	24	-
	DS24c	7.5	250	130	-	-	-	-	SS	24	-
	DSN37c	2	480	130	-	66 + 67	Poly	-	-	37	-
	DSN37c	7.5	480	130	-	66 + 67	Poly	-	-	37	-
	DS37c	2	480	130	-	-	-	-	SS	37	-
	DS37c	7.5	480	130	-	-	-	-	SS	37	-

* The indicated ratings do not apply to devices with SS casings
 † Up to 250VAC

Model	Current Interruption Rating*	Horsepower Ratings (see catalog section for other voltages)			Main Contacts Wire Size Capacity		Terminal Type
		240V - 3Ø	480V - 3Ø	600V - 3Ø	Min	Max	
PN	Current Interrupting	-	-	-	14 AWG	8 AWG	Screw
PN	Current Interrupting	-	-	-	14 AWG	8 AWG	Screw
PN	Non-Current Interrupting	-	-	-	14 AWG	8 AWG	Screw
PNHT	Non-Current Interrupting	-	-	-	14 AWG	8 AWG	Screw
PNHT	Current Interrupting	-	-	-	14 AWG	8 AWG	Screw
PNHT	Non-Current Interrupting	-	-	-	14 AWG	8 AWG	Screw
DSDC1	Non-Current Interrupting	-	-	-	14 AWG	8 AWG	Screw
DSDC1	Non-Current Interrupting	-	-	-	14 AWG	8 AWG	Screw
DSDC1	Non-Current Interrupting	-	-	-	14 AWG	8 AWG	Screw
DSDC3	Non-Current Interrupting	-	-	-	14 AWG	6 AWG	Screw
DSDC3	Non-Current Interrupting	-	-	-	14 AWG	6 AWG	Screw
DSDC3	Non-Current Interrupting	-	-	-	14 AWG	6 AWG	Screw
DSDC6	Non-Current Interrupting	-	-	-	10 AWG	2 AWG	Screw
DSDC6	Non-Current Interrupting	-	-	-	10 AWG	2 AWG	Screw
DSDC6	Non-Current Interrupting	-	-	-	10 AWG	2 AWG	Screw
DSDC9	Non-Current Interrupting	-	-	-	8 AWG	2/0 AWG	Screw
DSDC9	Non-Current Interrupting	-	-	-	8 AWG	2/0 AWG	Screw
DSDC2	Non-Current Interrupting	-	-	-	4 AWG	2/0 AWG	Screw
DSDC2	Non-Current Interrupting	-	-	-	4 AWG	2/0 AWG	Screw
PN12c	Current Interrupting	-	-	-	18 AWG	14 AWG	Solder
PN12c	Non-Current Interrupting	-	-	-	18 AWG	14 AWG	Solder
DSN24c	Current Interrupting	-	-	-	18 AWG	14 AWG	Solder
DSN24c	Non-Current Interrupting	-	-	-	18 AWG	14 AWG	Solder
DS24c	Current Interrupting	-	-	-	18 AWG	14 AWG	Solder
DS24c	Non-Current Interrupting	-	-	-	18 AWG	14 AWG	Solder
DSN37c	Current Interrupting	-	-	-	18 AWG	14 AWG	Solder/Crimp
DSN37c	Non-Current Interrupting	-	-	-	18 AWG	14 AWG	Solder/Crimp
DS37c	Current Interrupting	-	-	-	18 AWG	14 AWG	Solder/Crimp
DS37c	Non-Current Interrupting	-	-	-	18 AWG	14 AWG	Solder/Crimp

* 'Current Interrupting' rating applies to alternating current only.

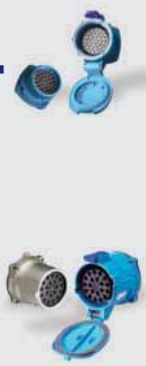
Meltric Product Summary and Selection Guide

	Model	Amp Rating	Maximum Voltage Rating		Environmental Ratings		Available Casing Materials			Maximum Number of Contacts	
			VAC	VDC	Type	IP	Poly	Metal	SS	Main	Auxiliary
Multipin 	PN7c	15	600	130	-	66 + 67*	Poly	Metal	SS	6P+G	-
	PN7c	20	600	130	-	66 + 67*	Poly	Metal	SS	6P+G	-
	DN9c	20	480	130	-	54/55	-	Metal	-	9	-
	DN20c	20	480	130	-	54/55	-	Metal	-	20	-
	DN7c	50	480	130	-	54/55	-	Metal	-	6P+G	-
	DN7c	90	480	130	-	54/55	-	Metal	-	6P+G	-
	DN7c	150	480	130	-	54/55	-	Metal	-	6P+G	-
	DS7c	30	600	130	-	54/55	Poly	Metal	-	7	3
DR7c	50	600	130	-	54/55	Poly	Metal	-	7	3	
High Ampacity 	PFQ	300	600	250	-	66 + 67	-	Metal	-	3P+N+G	8
	PF300	300	600	250	-	66 + 67	-	Metal	-	3P+N+G	4
	PF400	400	600	250	-	66 + 67	-	Metal	-	3P+N+G	4
	PF600	600	600	250	-	66 + 67	-	Metal	-	3P+N+G	4
	SP	600	600	1500	-	66 + 67	Poly	-	-	1P	-
	CS1000	400	1000	1500	-	66 + 67	Poly	-	-	1P	-

* The indicated ratings do not apply to devices with SS casings

Model	Current Interruption Rating	Horsepower Ratings (see catalog section for other voltages)			Main Contacts Wire Size Capacity		Terminal Type
		240V - 3Ø	480V - 3Ø	600V - 3Ø	Min	Max	
PN7c	Current Interrupting	-	-	-	18 AWG	10 AWG	Screw
PN7c	Non-Current Interrupting	-	-	-	18 AWG	10 AWG	Screw
DN9c	Current Interrupting	3 HP	5 HP	-	16 AWG	10 AWG	Screw
DN20c	Current Interrupting	1 HP	3 HP	-	16 AWG	10 AWG	Screw
DN7c	Non-Current Interrupting	-	-	-	14 AWG	6 AWG	Screw
DN7c	Non-Current Interrupting	-	-	-	8 AWG	2 AWG	Screw
DN7c	Non-Current Interrupting	-	-	-	4 AWG	2/0 AWG	Screw
DS7c	Current Interrupting	-	-	-	14 AWG	8 AWG	Screw
DR7c	Non-Current Interrupting	-	-	-	14 AWG	8 AWG	Screw
PFQ	Non-Current Interrupting	-	-	-	2 AWG	600 MCM	Lug
PF300	Non-Current Interrupting	-	-	-	2 AWG	600 MCM	Lug
PF400	Non-Current Interrupting	-	-	-	2 AWG	600 MCM	Lug
PF600	Non-Current Interrupting	-	-	-	2 AWG	600 MCM	Lug
SP	Non-Current Interrupting	-	-	-	2/0 AWG	777 MCM	Lug
CS1000	Non-Current Interrupting	-	-	-	2/0 AWG	444 MCM	Lug

Meltric Part Numbering...



First seven (7) digits for a basic inlet or receptacle part number

One (1) to six (6) suffixes for special features

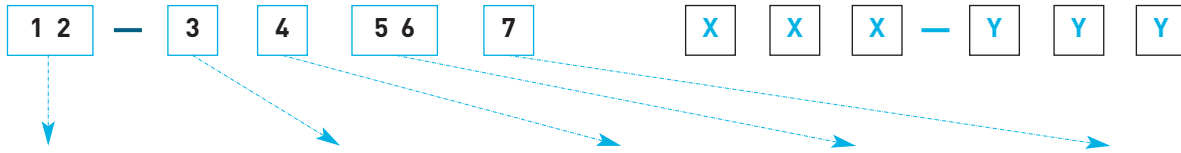

Meltric Product Line Type and Casing Material	AMP (A) Rating		Form and Mounting	Voltage Polarization		Phasing
	Position	Voltage		Hz		
PN 01 = Blue Poly 09 = Blue Metal DN 17 = Blue Metal DXN 22 = Black Poly DX 26 = Black Metal DS 33 = Blue Poly 35 = Black Poly 37 = Blue Metal DR 31 = Blue Poly 39 = Blue Metal PF 49 = Gray Metal PFQ 47 = Gray Metal DSN 63 = Blue Poly 65 = Black Poly DB 89 = Blue Metal	DSN 1 = 20 3 = 30 6 = 60 DS 1 = 20 3 = 30 6 = 60/100C 9 = 100 2 = 200* DB 3 = 30* 6 = 60* 9 = 100* DR 1 = 30 3 = 50 6 = 100 9 = 150 2 = 250* PN N = 20 (IP66+IP67) S = 20 (IP54/IP55) 2 = 20 3 = 30 <i>* Available in metal only</i>	DXN 1 = 20 3 = 30 6 = 60 DX 2 = 20* 3 = 30* 6 = 60* 9 = 100* PF 3 = 300* 4 = 400* 6 = 600* PFQ 3 = 300* DN 1 = 20*(DN9) 6 = 20*(DN20)	Female 4 = Receptacle Male 8 = Inlet DX, DXN37c, PXN12c, SPeX Only Female 0 = Receptacle on box 3 = Connector 4 = Receptacle Male 1 = Plug 6 = Inlet on Box	01 = $\frac{220 - 250}{380 - 440}$ 02 = $\frac{20}{24}$ 03 = $\frac{110 - 130}{190 - 230}$ 04 = $\frac{255 - 277}{440 - 480}$ 06 = $\frac{25}{28}$ 07 = $\frac{110 - 125}{220 - 250}$ 08 = $\frac{20}{24}$ 09 = $\frac{480}{500}$ 10 = $\frac{110}{130}$ 11 = $\frac{115 - 127}{200 - 220}$ 12 = $\frac{115 - 127}{200 - 220}$ 13 = $\frac{40}{48}$ 14 = $\frac{347}{600}$ 16 = $\frac{120 - 127}{208 - 220}$ 17* = $\frac{110 - 125}{220 - 250}$ 18* = $\frac{347}{600}$ 19 = $\frac{380 - 400}{660 - 690}$ 20 = $\frac{220}{250}$ 22 = $\frac{577}{1000}$ 23* = $\frac{120 - 127}{208 - 220}$ 24* = $\frac{255 - 277}{440 - 480}$ <i>* For DS100C and DR devices</i>	AC 2 = 2P+G AC 3 = 3P+G AC 5 = 1P+N+G AC 6 = 2P+N+G AC 7 = 3P+N+G AC A+ = 2P AC B+ = 3P AC C+ = 3P+N AC D+ = 1P+N AC G+ = 2P+N AC DC 8++ = 2P+G DC 9 = 2P+G DC Z+ = 2P DC <i>+ For 50V or less only</i> <i>**Includes jumpers</i>	

Notes: * On metal devices, plugs are not painted, receptacles are painted.

* This is the Keying Standard for Meltric products. Suffixes are available to accommodate non-interchangeable devices of the same size at the same voltage. Please ask for more details.

...and Ordering Guide

A MODULAR SYSTEM

Meltric products are ordered and assembled in a modular fashion. Customers should select the desired male inlet and female receptacle part numbers. Then matching accessories such as handles, angles, and junction boxes should be identified and added to the order to create plugs, connectors, or other configurations. This modular system allows Meltric to build and ship product to customer specifications in a very short time - 90% of orders ship by the next business day.

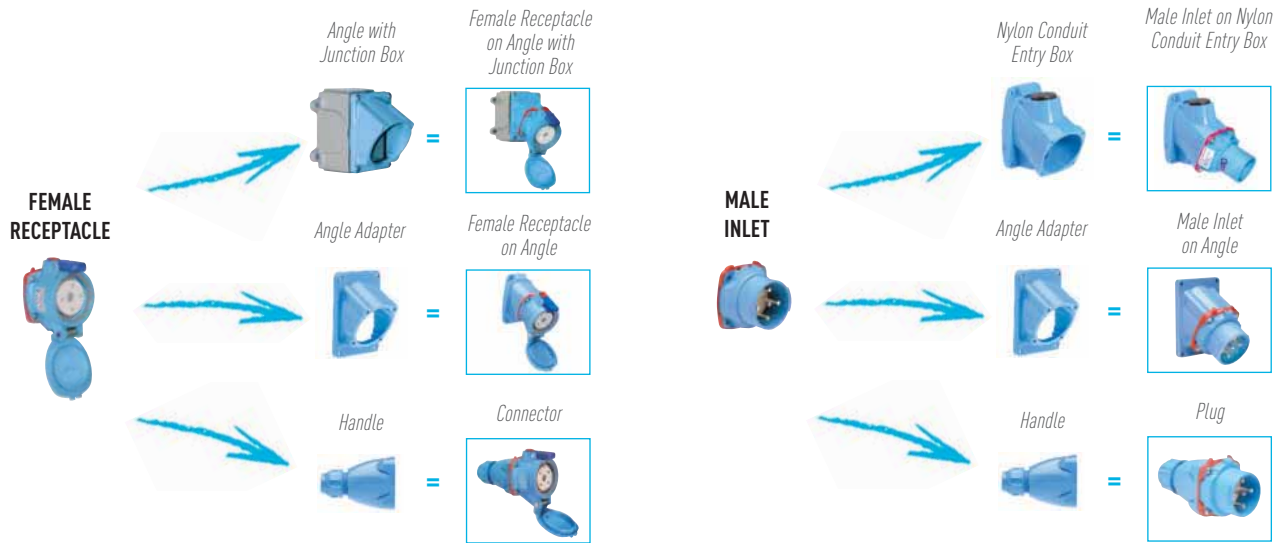



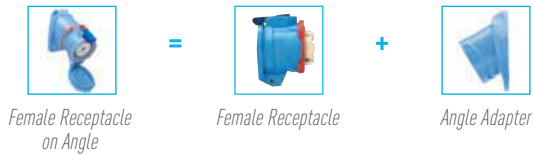

EXAMPLE

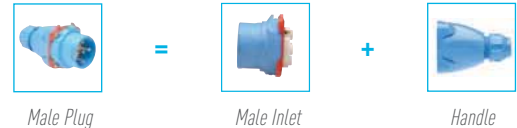

EXAMPLE



TYPICAL ORDER

-  63-34047 Female Receptacle
-  61-3A027 Angle Adapter for Female
-  63-38047 Male Inlet
-  61-3A013 Handle for Male

DECONTACTOR™ Series Switch Rated Plugs & Receptacles

The Main Differences



*Pressing the pawl/button on the receptacle will safely switch off the DECONTACTOR. The plug can then be withdrawn in complete safety.
(Cutaway model shown for illustration purposes)*

Like most Meltric products
Decontactors feature (see pgs 6-8)

- ▶ Spring-loaded butt contacts
- ▶ Silver-nickel contact materials
- ▶ Dead front construction
- ▶ Enclosed arc chambers
- ▶ Spring-assisted terminals
- ▶ Auxiliary contacts

Only Decontactor™ products
also feature:

- ▶ UL & CSA switch ratings
- ▶ Horsepower ratings
- ▶ Short circuit ratings up to 100 kA
in fuse protected circuits

Switch and Hp Ratings

Decontactors are a combination plug, receptacle and disconnect switch in the same device. The Decontactors integral switch technology ensures the safe breaking of resistive and inductive loads (up to 60 hp or 200A) before the plug can be removed from the receptacle.

Decontactors are UL and CSA approved for both “branch circuit” and “motor circuit” disconnect switching, so they are ideal for connecting motors, welding machines and virtually any other electrical equipment.



To match the functionality of a DECONTACTOR, it would take a pin and sleeve plug plus a non-fused safety switch.

Short Circuit Ratings

Decontactors help ensure worker safety even in fault conditions. All Decontactors are rated to close into and withstand short circuit currents of 65 kA to 100 kA. The protection far surpasses that offered by other plugs and receptacles, and even surpasses the short circuit protection offered by most manual motor controllers and mechanical interlocks.



*Don't let this happen to you!
Pin and sleeve devices are not safe to make and break
under load - Meltric Decontactors are.*

UL & CSA Standards

Test requirements and ratings comparison table

To attain their switch ratings, DECONTACTOR™ Series plugs and receptacles passed electrical and mechanical endurance tests, horsepower/locked rotor overload tests, and short circuit make and withstand tests that far exceed the tests passed by ordinary plugs and receptacles. In fact, the tests performed to achieve the Decontactor's switch ratings are the same electrical performance tests required of manual motor controllers and enclosed disconnect switches (UL 508 and UL 98 type devices).

The chart below compares the test requirements for achieving a Switch Rated Plug & Receptacle listing with those required for a standard pin and sleeve type plug & receptacle listing.

Test	UL 1682 & CSA 22.2 No. 182.1		UL Subject 2682 (used for both UL & CSA listings)
	Plugs, Receptacles & Cable Connectors of the Pin & Sleeve Type		Switch Rated Plugs & Receptacles
	Non-Current Interrupting Break (minimum requirements)	Current Interrupting (minimum requirements)	Motor Circuit/Branch Circuit Disconnect Switching (Tests passed by DECONTACTOR devices)
Temperature Rise	< 30°C	< 30°C	< 30°C
Voltage Withstand	1000V + 200% of Device Rating	1000V + 200% of Device Rating	1000V + 200% of Device Rating
Overload General Use Devices	3 Operations @ 150% of Rated Current (p.f. = .75 - .80)	50 Operations @ 150% of Rated Current (p.f. = .75 - .80)	50 Operations @ 150% of Rated Current (p.f. = .75 - .80)
Mechanical Endurance (Plus Req'd Electrical Opns)	15-20A = 5000 Opns 21-63A = 2000 Opns 64-250A = 250 Opns	15-20A = 0 Opns 21-63A = 1000 Opns 64-250A = 500 Opns	covered by Electrical Endurance test
Electrical Endurance (With Load)	-	15-20A = 5000 Opns 21-63A = 1000 Opns ¹ 64-250A = 250 Opns ¹ @ Rated Current & Voltage (p.f. = .75 - .80)	6000 Cycles @ Rated Current & Voltage (p.f. = .75 - .80)
Overload - Locked Rotor (Horsepower Rated Devices)	-	-	50 Operations @ 600% of Full Load Motor Current (p.f. = .40 - .50)
Short Circuit Withstand	-	-	≥ 10 kA ⁺ (600V and ≤ .50 power factor)
Short Circuit	-	-	≥ 10 kA ⁺ (600V and ≤ .50 power factor)

¹ Testing alternates between mechanical & electrical operations. This reduces the severity of the electrical test by allowing additional cooling time during electrical testing.
+ All Meltric switch rated Decontactors are UL listed with short circuit ratings of at least 65kA achieved at 600VAC and ≤ .15 power factor.



Benefit from Using Decontactors...

Ensure Worker Safety

Meltric Decontactors help ensure safety by eliminating the hazards associated with pin & sleeve and twist-type devices.

- ▶ The integral switching function ensures that the plug contacts are dead prior to removal from the receptacle and the dead front construction prevents unintended access to live parts. This eliminates potential injury due to electrical shock.
- ▶ Spring-loaded, silver-nickel butt style contacts maintain proper contact force, withstand arcing, resist wear, and maintain low contact resistance. This ensures the integrity of the connection over thousands of operations and eliminates injuries caused by heat, oxidation, wear and arcing induced failures of brass contacts.
- ▶ Push button operation and spring-loaded plug and receptacle disengagement ensures quick and operator independent load breaking. This helps minimize harmful arcing during disconnection and enclosed arc chambers eliminate the possibility of external arcs.
- ▶ Horsepower, switch and short circuit ratings provide significant additional protection during locked-rotor or other significant overload situations. This eliminates injuries that could occur with standard plug and receptacles.



Simplify Code Compliance

Decontactors provide a simple and cost effective means of helping facilities to achieve compliance with the National Electric Code and NFPA 70E.

NEC Compliance

Articles 430.101 through 430.113 of the National Electrical Code regulate motor disconnection means (Canadian Electrical Code section 28-600 – 28-604). They require motors to have readily accessible, 'line of sight' disconnects that are either an approved switch or a properly rated plug and receptacle.

- ▶ **430.102** A disconnecting means must be located in sight from the motor and driven equipment.
- ▶ **430.107** The disconnecting means must be readily accessible.
- ▶ **430.109** The disconnecting means must be an approved switch or horsepower rated plug & receptacle.

Meltric's DECONTACTOR Series plugs and receptacles are both horsepower and switch rated. Thus, they can function as a 'line of sight' disconnect in addition to providing a convenient plug and play power connection for the motor. The need for an auxiliary disconnect switch is eliminated.

NFPA 70E (CSA Z462)

This OSHA consensus standard covers electrical safety related work practices and procedures for employees who work on or near exposed energized electrical conductors or other live circuit parts. Relevant requirements include:

Power must be proven to be off before work can be performed. This requires:

- ▶ The safe interruption of the load & opening of the disconnect
- ▶ Visual verification/voltage testing to ensure deenergization

The potential electrical hazard must be identified and documented.

- ▶ Flash hazard analysis must be performed
- ▶ Flash protection boundaries must be determined

Appropriate steps must be taken to protect persons working near live parts or within the flash protection boundary.

- ▶ PPE must be worn based on incident energy exposure levels (cal/cm²)
- ▶ Only properly qualified persons are allowed to perform work

...Throughout your Facility

Wiring and connection systems utilizing conventional switches and/or pin & sleeve devices would typically require all of the previously listed protective measures to comply with NFPA 70E or CSA Z462. By using Meltric's DECONTACTOR Series plugs and receptacles to connect equipment, users can very simply comply with these requirements.

Switch ratings ensure the safe interruption of the load and removing the plug from the receptacle provides visual verification that the power is off. Dead front construction prevents exposure to live parts and thus eliminates the need to perform hazard analysis, establish flash protection boundaries and use electrical personal protective equipment.

Motor Change-Out Process Comparison

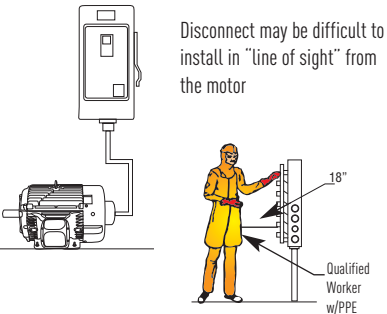
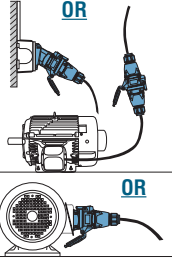
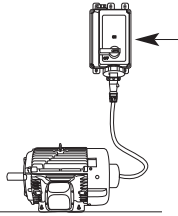
MOTOR HARD-WIRED TO A BLADED DISCONNECT SWITCH	MOTOR CONNECTED WITH A MELTRIC MOTOR PLUG	MOTOR CONNECTED WITH A COMPETITIVE PLUG & RECEPTACLE
 <p>Disconnect may be difficult to install in "line of sight" from the motor</p> <p>18"</p> <p>Qualified Worker w/PPE</p>	 <p>OR</p> <ul style="list-style-type: none"> ▶ Cord connection allows easy "line of sight" location ▶ Dead front eliminates access to live parts and need for cumbersome PPE ▶ Ability to safely make & break under load eliminates the need for interlocks ▶ ≥ 65kA short circuit make and withstand rating ensures safety during reenergization <p>OR</p>	 <ul style="list-style-type: none"> ▶ Expensive mechanical interlocks are required since these plugs & receptacles cannot safely make & break under load ▶ The interlock must be mounted on a fixed surface this may make "line of sight" location more difficult
MOTOR CHANGE-OUT PROCESS	MOTOR CHANGE-OUT PROCESS	MOTOR CHANGE-OUT PROCESS
<ol style="list-style-type: none"> 1. Switch disconnect to OFF position 2. Apply lockout/tagout 3. Perform Shock/Arc Flash Hazard Analysis 4. Obtain permit for energized electrical work 5. Suit up with appropriate PPE 6. Remove the disconnect switch cover 7. Voltage test to verify deenergization 8. Disconnect motor from hard-wiring 9. Remove old/install new motor 10. Connect new motor to hard-wiring 11. Jog the motor to ensure proper rotation 	<ol style="list-style-type: none"> 1. Switch Decontactor receptacle to OFF position 2. Mechanic removes plug from receptacle 3. Apply lockout/tagout as required 4. Mechanic removes old/install new motor 5. Mechanic inserts plug into receptacle <p style="text-align: center;">Meltric Makes it Safe & Easy</p>	<ol style="list-style-type: none"> 1. Open interlock switch 2. Determine PPE requirements & obtain 3. Remove interlock cover 4. Voltmeter test to verify deenergization 5. Remove plug 6. Apply lockout/tagout as required 7. Remove old/install new motor 8. Insert plug into receptacle

Reduce Equipment & Installation Costs

A Decontactor's ability to safely make and break under full load eliminates the need for the expensive interlocks that are required with pin and sleeve devices. Their ability to function as the NEC required 'line of sight' disconnect eliminates the need for auxiliary disconnect switches and their optional pilot contacts can eliminate the need for auxiliary connectors for control circuits.

Reduce Equipment Change-out Downtime & Cost

Using Meltric's DECONTACTOR Series plug and receptacles to connect motors and other equipment instead of hard-wiring can help reduce equipment change-out time by as much as 50%. With new motors pre-wired with Decontactor plugs or inlets, the only electrical connection required during the change-out will be to plug in the new motor. Thus, a mechanic will be able to perform the change-out without the immediate aid of an electrician. This avoids the scheduling hassle of needing to also provide an electrician and eliminates the extra downtime required to do the wiring. The pre-wiring of replacement motors with Decontactor plugs or inlets can be done off-site and during the convenience of non-downtime periods. This makes Decontactor Series plugs and receptacles an ideal choice for 'plug and play' and modular process applications.

Selecting the Right DECONTACTOR™ Family

All Decontactors
(DSN, DS and DB)
feature:



- ▶ UL & CSA switch ratings
- ▶ Short circuit closing and withstand protection (65kA to 100kA)



- ▶ Silver-nickel contact material
- ▶ Spring-loaded, butt-style contacts



- ▶ Dead front safety shutter
- ▶ Optional auxiliary contacts



DSN Series

(pages 23-34)

Choose DSN Series for its...

- ▶ Compact, lightweight design
- ▶ Automatic Type 4X watertightness

Common Applications

- ▶ Wet or washdown environments
- ▶ Plug & play electrical connections



DS Series

(pages 35-52)

Choose DS Series for its...

- ▶ High amperage range (up to 200A)
- ▶ Poly or metal casing materials (60A and above)
- ▶ Larger conductor capacities

Common Applications

- ▶ Heavy industry
- ▶ High amperage equipment



DB Series

(pages 53-66)

Choose DB Series for its...

- ▶ High HP ratings (up to 60 hp)
- ▶ Robust, heavy duty construction

Common Applications

- ▶ Motors with frequent make and break requirements
- ▶ Harsh environments

DSN Models and Ratings

Model	Casing Material	Maximum Voltage (VAC)	Amperage Rating	Maximum Number of Contacts		Environmental Rating	Maximum Horsepower Rating	
				Main	Auxiliary		480 VAC	600 VAC
DSN20	Poly	480 VAC	20A	3P+N+G	-	Type 4X IP66+IP67	5 hp	-
DSN30	Poly	600 VAC	30A	3P+N+G	2	Type 4X IP66+IP67	10 hp	15 hp
DSN60	Poly	600 VAC	60A	3P+N+G	4	Type 4X IP66+IP67	20 hp	20 hp

DS Models and Ratings

Model	Casing Material	Maximum Voltage (VAC)	Amperage Rating	Maximum Number of Contacts		Environmental Rating	Maximum Horsepower Rating	
				Main	Auxiliary		480 VAC	600 VAC
DS20	Poly	600 VAC	20A	3P+N+G	2	Type 3R	5 hp	7.5 hp
DS30	Poly	600 VAC	30A	3P+N+G	4	Type 3R	10 hp	-
DS60	Poly or Metal	600 VAC	60A	3P+N+G	3	Type 3R	20 hp	25 hp
DS100C	Poly or Metal	600 VAC	100A	3P+N+G	3	Type 3R	20 hp	25 hp
DS100	Poly or Metal	600 VAC	100A	3P+N+G	6	Type 3R	-	-
DS200	Metal	480 VAC	200A	3P+N+G	5	Type 3R	-	-

DB Models and Ratings

Model	Casing Material	Maximum Voltage (VAC)	Amperage Rating	Maximum Number of Contacts		Environmental Rating	Maximum Horsepower Rating	
				Main	Auxiliary		480 VAC	600 VAC
DB30	Zinc Aluminum	600 VAC	30A	3P+N+G	2	IP67	10 hp	10 hp
DB60	Zinc Aluminum	600 VAC	60A	3P+N+G	2	IP67	30 hp	30 hp
DB100	Zinc Aluminum	600 VAC	100A	3P+N+G	4	IP67	60 hp	60 hp

DSN



Features and Ratings	p. 24
DSN20	p. 25
DSN30	p. 27
DSN60	p. 29
Spare parts	p. 31
Dimensions	p. 33



Switch rated plug and receptacle with Type 4X protection

DSN Series products are switch and hp rated for quick, safe equipment changeouts. DSN's are ideal for wet environments since they offer Type 4X watertightness as soon as the plug is latched to the receptacle or as soon as the receptacle lid is closed.

Main Advantages

- ▶ Switch & Hp rated
- ▶ 100 kA short circuit rated*
- ▶ Type 4X, IP66/67
- ▶ Compact, lightweight design
- ▶ Up to 4 auxiliary contacts

Highlighted Advantage

Simplify Compliance to
NFPA 70E & CSA Z462

See pgs 19-20 for
more information



* See note under General Ratings on the next page

Product Features

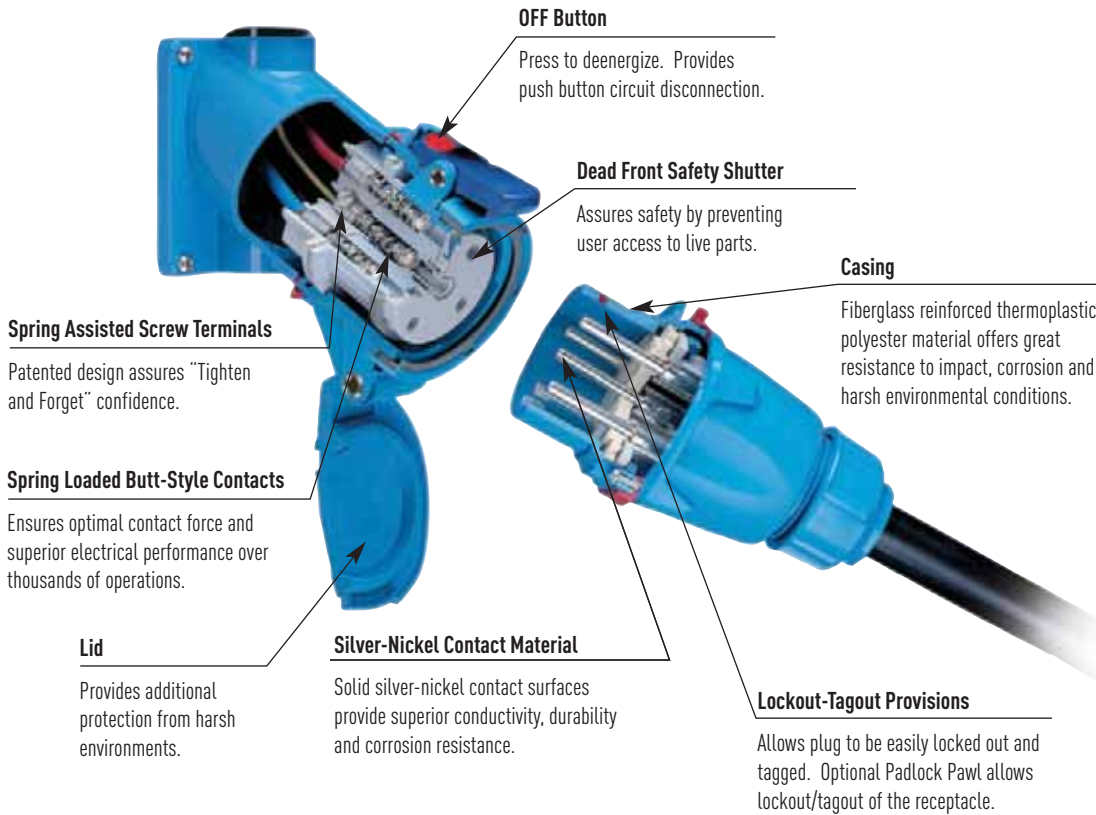

General Ratings

Amperage	20 to 60A
Voltage	600 VAC*
Frequency	50-400 Hz
Horsepower	1/2 to 20 hp
Short-Circuit (Make & Withstand)	100kA**
Environmental	Type 4X, IP66+IP67
Temperature	min -40°F/max 140°F

* DSN20 devices are 480 VAC

** Testing was performed with RK1 current limiting fuses sized at 400% or more of the highest full load motor ampacity associated with the devices horsepower ratings.

Listings

Category	UL	CSA	IEC
Plugs and Receptacles	UL 1682	C22.2 No. 182.1	60309-1
Branch Circuit Disconnect Switching (AC only)	UL Subject 2682 (Performance tests from UL 98)	UL Subject 2682	60947-3, AC22, AC23
Motor Circuit Disconnect Switching (AC only)	UL Subject 2682 (Performance tests from UL 508)	UL Subject 2682	

CE ratings available upon request

Highlighted Feature

Typical Device Labels

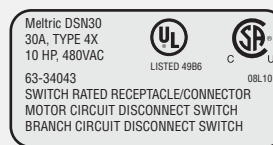

DSN Deconnectors are UL & CSA rated for "motor circuit" and "branch circuit" disconnect switching – up to 20 hp and up to 60A

Operating Instructions

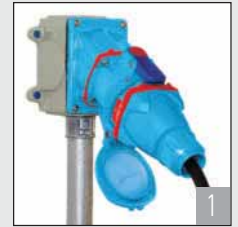

When the plug and receptacle are latched together, the circuit is connected.

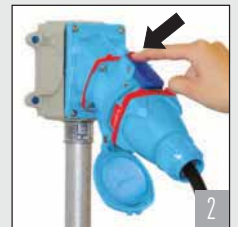

Pressing the pawl causes the DECONTACTOR to break the circuit. The plug is ejected to its rest position; its contacts are now dead.



Rotating the 'dead' plug 30° counterclockwise closes the safety shutter and frees the plug to be withdrawn from the receptacle.



The plug and the receptacle are separated. The safety shutter prevents access to live parts.

5 To reconnect, insert plug into receptacle, rotate 30° clockwise, and apply insertion force.

DSN20



DECONTACTOR™ – 20A

Switch Rated Plugs & Receptacles

Ratings

- Voltage**
480 VAC
- Switch Rating (AC Only)**
Branch Circuit & Motor Circuit Disconnect Switching
- Horsepower Ratings**

120V	1Ø	1/2 hp
240V	1Ø	1 hp
208V	3Ø	2 hp
240V	3Ø	2 hp
480V	3Ø	5 hp
- Short Circuit Rating**
100kA Close & Withstand
Testing was performed with RK1 current limiting fuses sized at 400% of the highest full load motor ampacity associated with the devices hp rating.
- Environmental Ratings**
Type 4X, IP66+IP67
- Temperature Range**
Min -40°F/Max 140°F
See pg 220 for temps below -15°F.
- Wiring Capacity**
Min 14 AWG Max 12 AWG
- Listings**
UL, CSA, IEC, CE*
* Contact Customer Service

Receptacle (female)



Don't forget to add installation accessories to your order

Inlet (male)



Voltage	Polarity	Part # Poly
120/208V	3P+N+G	63-14167
125V	1P+N+G	63-14075
125/250V	2P+N+G	63-14076
208V	2P+G	63-14162
208V	3P+G	63-14163
250V	2P+G	63-14072
250V	3P+G	63-14073
277V	1P+N+G	63-14045
277/480V	3P+N+G	63-14047
347/600V	3P+N+G	-
480V	2P+G	63-14042
480V	3P+G	63-14043
600V	2P+G	-
600V	3P+G	-

Voltage	Polarity	Part # Poly
120/208V	3P+N+G	63-18167
125V	1P+N+G	63-18075
125/250V	2P+N+G	63-18076
208V	2P+G	63-18162
208V	3P+G	63-18163
250V	2P+G	63-18072
250V	3P+G	63-18073
277V	1P+N+G	63-18045
277/480V	3P+N+G	63-18047
347/600V	3P+N+G	-
480V	2P+G	63-18042
480V	3P+G	63-18043
600V	2P+G	-
600V	3P+G	-

Other voltage configurations are available – contact customer service at 800.433.7642.

Main Options



Mushroom Pawl



Padlock Pawl



Closed Lid Configuration

Recommended for cord applications to keep lid tucked in to avoid damage.

Receptacle Options	Suffix #
Straight Insertion	Recept # - A188
Self-Ejecting Connector Release	Recept # - 345-A188
Mushroom Pawl	Recept # - 375
Padlock Pawl	Recept # - 843
Padlockable Mushroom Pawl	Recept # - 375-843
Metal Pawl	Recept # - 824
Closed Lid Configuration	Recept # - NC

Inlet Options	Suffix #
Self-Ejecting Plug Release	Inlet # - 338-A188
Straight Insertion	Inlet # - A188
With No Lockout Hole	Inlet # - A155

DSN20 Order Example:

To order a receptacle with a padlock pawl add **-843** the receptacle part number.

DSN20 receptacle 3P+G= 63-14043-**843**

Appropriate accessory numbers must also be included on the order

How to Order

Receptacle and Inlet (see above)



Accessories

Angle, Handle, etc are interchangeable (see opposite page)

Installation Accessories

Handles



NPT	Poly Handle	Cable Range	Nylon Handle	Extended Handle	Angled Handle
1/2"	61-1A013-12	.20 - .82	-	61-1A413	-
3/4"	61-1A013-34	.35 - .70	61-1A013	-	61-1A313
1"	61-1A013-1				

Notes:

- Finger draw plates are recommended for easier connector closure on cord to cord assemblies.
- For available cord grips, see pgs 193-194.

For a guideline of NPT sizes based on cable ranges, see DSN30 on pg 28.

Angles



Nylon 30° Angle	Metal 45° Angle	Nylon 30° Angle for MB Box	Metal 30° Angle/ Adapter Plate for FS Box	Metal Straight Adapter
61-1A027	MA1	61-1A027-601	MAFS1*	MS1

* Includes angle, adapter plate and gaskets for FS box mounting

Accessory Spotlight

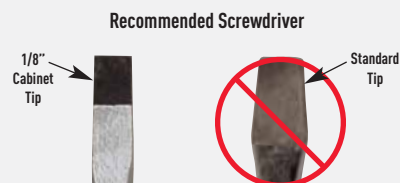

DSN20 terminal screws can be tightened or loosened with a 1/8" cabinet tip screwdriver. Meltric recommends Klein 608 Series or equal. The terminal screws on DSN20 devices cannot be properly accessed with a standard screwdriver.

Junction Boxes

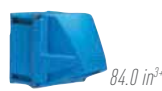

NPT	Metal Box	Metal Box with Nylon Angle	Poly* Conduit Entry	Poly 70°** Wall Box
1/2"	MB312	61-1A053-080-12	61-1A023-12	51-AA058
3/4"	MB334	61-1A053-080-34	61-1A023-34	51-AA058
1"	MB31	61-1A053-080-1	-	51-AA058
1 1/4"	MB3114	61-1A053-080-114	-	51-AA058

* For poly devices only
 ** 70° boxes are not drilled. Contact customer service if factory drilling is required.
 * Interior volume with receptacle installed.

Miscellaneous Accessories



* Set of Two (2)



For Male Devices Only



For Male Devices Only



Finger Drawplates	Protective Cap	Padlockable Plug Cap	Screwdriver for Terminal Screws
61-1A346	61-1A426	61-1A826	SD18**

* Recommended for cord to cord assembly applications, for easier connector closure
 ** Klein 608-3 1/8" cabinet tip screwdriver with 3" round shank

Order Example

A typical order should include an inlet part number, a receptacle part number **AND** the matching handles, angles or other required accessories.



Male Inlet with Handle (Plug)
 63-18043 + 61-1A013



Female Receptacle with Angle Adapter
 63-14043 + 61-1A027

DSN30



DECONTACTOR™ – 30A

Switch Rated Plugs & Receptacles

Ratings

- Voltage**
600 VAC
 - Switch Rating (AC Only)**
Branch Circuit & Motor Circuit Disconnect Switching
 - Horsepower Ratings**

120V	1Ø	1 hp
240V	1Ø	3 hp
208V	3Ø	5 hp
240V	3Ø	5 hp
480V	3Ø	10 hp
600V	3Ø	15 hp
 - Short Circuit Rating**
100kA Close & Withstand
Testing was performed with RK1 current limiting fuses sized at 400% of the highest full load motor ampacity associated with the devices hp rating.
 - Environmental Ratings**
Type 4X, IP66+IP67
 - Temperature Range**
Min -40°F/Max 140°F
See pg 220 for temps below -15°F.
 - Wiring Capacity**
Min 14 AWG Max 8 AWG
Aux Contacts - 14 AWG
 - Listings**
UL, CSA, IEC, CE*
- * Contact Customer Service

Receptacle (female)



Don't forget to add installation accessories to your order

Inlet (male)



Voltage	Polarity	Part # Poly
120/208V	3P+N+G	63-34167
125V	1P+N+G	63-34075
125/250V	2P+N+G	63-34076
208V	2P+G	63-34162
208V	3P+G	63-34163
250V	2P+G	63-34072
250V	3P+G	63-34073
277V	1P+N+G	63-34045
277/480V	3P+N+G	63-34047
347/600V	3P+N+G	63-34147
480V	2P+G	63-34042
480V	3P+G	63-34043
600V	2P+G	63-34142
600V	3P+G	63-34143

Voltage	Polarity	Part # Poly
120/208V	3P+N+G	63-38167
125V	1P+N+G	63-38075
125/250V	2P+N+G	63-38076
208V	2P+G	63-38162
208V	3P+G	63-38163
250V	2P+G	63-38072
250V	3P+G	63-38073
277V	1P+N+G	63-38045
277/480V	3P+N+G	63-38047
347/600V	3P+N+G	63-38147
480V	2P+G	63-38042
480V	3P+G	63-38043
600V	2P+G	63-38142
600V	3P+G	63-38143

Other voltage configurations are available – contact customer service at 800.433.7642.

Main Options



Auxiliary / Pilot Contacts



Mushroom Pawl



Padlock Pawl



Closed Lid Configuration
Recommended for cord applications to keep lid tucked in to avoid damage.



See pgs 197-206 for detailed information on these options

Receptacle Options	Suffix #
With 2 Auxiliary / Pilot Contacts	Recept # - 972
Straight Insertion	Recept # - A188
Self-Ejecting Connector Release	Recept # - 345-A188
Mushroom Pawl	Recept # - 375
Padlock Pawl	Recept # - 843
Padlockable Mushroom Pawl	Recept # - 375-843
Metal Pawl	Recept # - 824
Closed Lid Configuration	Recept # - NC
With Auxiliary Switch	Recept # - 270*

Notes: * Not UL/CSA Listed

DSN30 Order Example:

To order 2 auxiliary contacts on an inlet and receptacle add -972 to the part numbers.

DSN30 Inlet 3P+G = 63-38043-972

DSN30 Receptacle 3P+G = 63-34043-972

Appropriate accessory part numbers must also be included on the order.

Inlet Options	Suffix #
With 2 Auxiliary / Pilot Contacts	Inlet # - 972
Self-Ejecting Plug Release	Inlet # - 338-A188
Straight Insertion	Inlet # - A188
With No Lockout Hole	Inlet # - A155
For Auxiliary Switch*	Inlet # - NNF

Notes: * Order inlet with P+N+G configuration and receptacle with P+G configuration

How to Order

Receptacle and Inlet (see above)

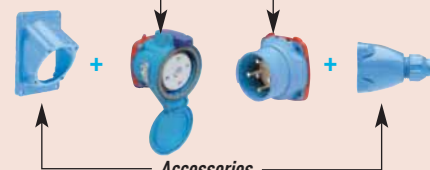

Angle, Handle, etc are interchangeable (see opposite page)

Installation Accessories

Handles



NPT	Poly Handle	Cable Range	Nylon Handle	Poly Handle w/Clamp & Bushing
1/2"	61-3A013-12	.20 - .82	61-3A013	-
3/4"	61-3A013-34	.750 - .875	-	1PM514
1"	61-3A013-1	.875 - 1.000	-	1PM516
1 1/4"	61-3A013-114	1.000 - 1.125	-	1PM518
		1.125 - 1.250	-	1PM520
		1.250 - 1.375	-	1PM522

- Notes:**
- Finger draw plates are recommended for easier connector closure on cord to cord assemblies.
 - For available cord grips, see pgs 193-194.

NPT Guidelines

Cable Range	NPT
.312 - .625	1/2"
.438 - .812	3/4"
.660 - 1.000	1"
.875 - 1.375	1 1/4"

NPT sizes are determined by the cable diameter and third party cord grip.

Angles



Nylon 30° Angle	Metal 30° Angle	Metal Angle FS/FD Box 30°	Metal Straight Adapter
61-3A027	MA2	MAFS2	MS2

Junction Boxes

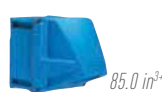
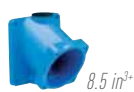

NPT	Metal Box	Metal Box with Nylon Angle	Poly* Conduit Entry	Poly 70°** Wall Box
1/2"	MB312	61-3A053-080-12	61-3A023-12	51-BA058
3/4"	MB334	61-3A053-080-34	61-3A023-34	51-BA058
1"	MB31	61-3A053-080-1	-	51-BA058
1 1/4"	MB3114	61-3A053-080-114	-	51-BA058

- * For poly devices only
 ** 70° boxes are not drilled. Contact customer service if factory drilling is required.
 * Interior volume with receptacle installed.

Miscellaneous Accessories



Finger Drawplates	Protective Cap	Padlockable Plug Cap	Screwdriver for Terminal Screws
61-3A346	61-3A126	61-3A826	SD18**

- * Recommended for cord to cord assembly applications, for easier connector closure
 ** Klein 608-3 1/8" cabinet tip screwdriver with 3" round shank

Accessory Spotlight

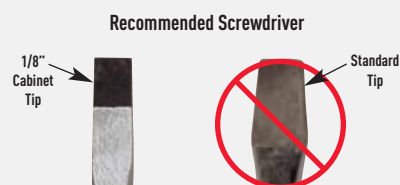

DSN30 terminal screws can be tightened or loosened with a 1/8" cabinet tip screwdriver. Meltric recommends Klein 608 Series or equal. The terminal screws on DSN30 devices cannot be properly accessed with a standard screwdriver.

Order Example

A typical order should include an inlet part number, a receptacle part number **AND** the matching handles, angles or other required accessories.



Male Inlet with Handle (Plug)
 63-38043 + 61-3A013



Female Receptacle with Angle Adapter
 63-34043 + 61-3A027

DSN60



DECONTACTOR™ – 60A

Switch Rated Plugs & Receptacles

Ratings

- Voltage**
600 VAC
 - Switch Rating (AC Only)**
Branch Circuit & Motor Circuit Disconnect Switching
 - Horsepower Ratings**

120V	1Ø	2 hp
240V	1Ø	3 hp
208V	3Ø	7 1/2 hp
240V	3Ø	7 1/2 hp
480V	3Ø	20 hp
600V	3Ø	20 hp
 - Short Circuit Rating**
100kA Close & Withstand
Testing was performed with RK1 current limiting fuses sized at 400% of the highest full load motor ampacity associated with the devices hp rating.
 - Environmental Ratings**
Type 4X, IP66+IP67
 - Temperature Range**
Min -40°F/Max 140°F
See pg 220 for temps below -15°F.
 - Wiring Capacity**
Min 12 AWG Max 4 AWG
Aux Contacts - Max 14 AWG
 - Listings**
UL, CSA, IEC, CE*
- * Contact Customer Service

Receptacle (female)



Don't forget to add installation accessories to your order

Inlet (male)



Voltage	Polarity	Part # Poly
120/208V	3P+N+G	63-64167
125V	1P+N+G	63-64075
125/250V	2P+N+G	63-64076
208V	2P+G	63-64162
208V	3P+G	63-64163
250V	2P+G	63-64072
250V	3P+G	63-64073
277V	1P+N+G	63-64045
277/480V	3P+N+G	63-64047
347/600V	3P+N+G	63-64147
480V	2P+G	63-64042
480V	3P+G	63-64043
600V	2P+G	63-64142
600V	3P+G	63-64143

Voltage	Polarity	Part # Poly
120/208V	3P+N+G	63-68167
125V	1P+N+G	63-68075
125/250V	2P+N+G	63-68076
208V	2P+G	63-68162
208V	3P+G	63-68163
250V	2P+G	63-68072
250V	3P+G	63-68073
277V	1P+N+G	63-68045
277/480V	3P+N+G	63-68047
347/600V	3P+N+G	63-68147
480V	2P+G	63-68042
480V	3P+G	63-68043
600V	2P+G	63-68142
600V	3P+G	63-68143

Other voltage configurations are available – contact customer service at 800.433.7642.

Main Options



Auxiliary/Pilot Contacts



Mushroom Pawl



Padlock Pawl



Closed Lid Configuration

Recommended for cord applications to keep lid tucked in to avoid damage.



See pgs 197-206 for detailed information on these options

Receptacle Options	Suffix #
With 2 Auxiliary/Pilot Contacts	Recept # - 972
With 3 Auxiliary/Pilot Contacts	Recept # - 973*
With 4 Auxiliary/Pilot Contacts	Recept # - 974*
Straight Insertion	Recept # - A188
Self-Ejecting Connector Release	Recept # - 345-A188
Mushroom Pawl	Recept # - 375
Padlock Pawl	Recept # - 843
Padlockable Mushroom Pawl	Recept # - 375-843
Metal Pawl	Recept # - 824
Closed Lid Configuration	Recept # - NC
With Auxiliary Switch	Recept # - 270*

Notes: * Not UL/CSA Listed

DSN60 Order Example:

To order 2 auxiliary contacts on an inlet and receptacle add -972 to the part numbers.

DSN60 Inlet 3P+G = 63-68043-972

DSN60 Receptacle 3P+G = 63-64043-972

Inlet Options	Suffix #
With 2 Auxiliary/Pilot Contacts	Inlet # - 972
With 3 Auxiliary/Pilot Contacts	Inlet # - 973*
With 4 Auxiliary/Pilot Contacts	Inlet # - 974*
Self-Ejecting Plug Release	Inlet # - 338-A188
Straight Insertion	Inlet # - A188
With No Lockout Hole	Inlet # - A155
For Auxiliary Switch*	Inlet # - NNF

Notes: * Order inlet with P+N+G configuration and receptacle with P+G configuration

How to Order

Receptacle and Inlet (see above)



Accessories
Angle, Handle, etc are interchangeable (see opposite page)

Installation Accessories

Handles



Makes connector closures easier

NPT	Poly Handle	Cable Range	Nylon Handle	Poly Handle w/Clamp & Bushing	Poly Handle w/built in Draw Grips
1/2"	61-6A013-12	.39 - 1.18	61-6A013	-	61-6A473
3/4"	61-6A013-34	.750 - .875	-	3PM514	-
1"	61-6A013-1	.875 - 1.000	-	3PM516	-
1 1/4"	61-6A013-114	1.000 - 1.125	-	3PM518	-
		1.125 - 1.250	-	3PM520	-
		1.250 - 1.375	-	3PM522	-

Notes:

- Finger draw plates are recommended for easier connector closure on cord to cord assemblies.
- For available cord grips, see pgs 193-194.

- For a guideline of NPT sizes based on cable ranges, see DSN30 on pg 28.

Angles



Nylon 30° Angle	Metal 30° Angle	Metal 70° Angle	Metal Angle FS/FD Box 30°	Metal Straight Adapter
61-6A027	MA3	89-3A027	MAFS3	MS3

Junction Boxes



NPT	Metal Box	Metal Box with Nylon Angle	Poly* Conduit Entry	Poly 70°** Wall Box
1/2"	MB312	61-6A053-080-12	61-6A023-12	51-CA058
3/4"	MB334	61-6A053-080-34	61-6A023-34	51-CA058
1"	MB31	61-6A053-080-1	61-6A023-1	51-CA058
1 1/4"	MB3114	61-6A053-080-114	-	51-CA058

* For poly devices only
 ** 70° boxes are not drilled. Contact customer service if factory drilling is required.
 * Interior volume with receptacle installed.

Miscellaneous Accessories



Set of Two (2)



For Male Devices Only



For Male Devices Only



Finger Drawplates	Protective Cap	Padlockable Plug Cap	Cord Grip w/Mesh
61-6A346	61-6A126	61-6A826	see pgs 193-194

Accessory Spotlight

Finger Drawplates



Finger drawplates are recommended for easier connector closure on cord to cord assemblies.

Order Example

A typical order should include an inlet part number, a receptacle part number **AND** the matching handles, angles or other required accessories.



Male Inlet with Handle (Plug)
 63-68043 + 61-6A013



Female Receptacle with Angle Adapter
 63-64043 + 61-6A027



Spare Parts Male Configuration

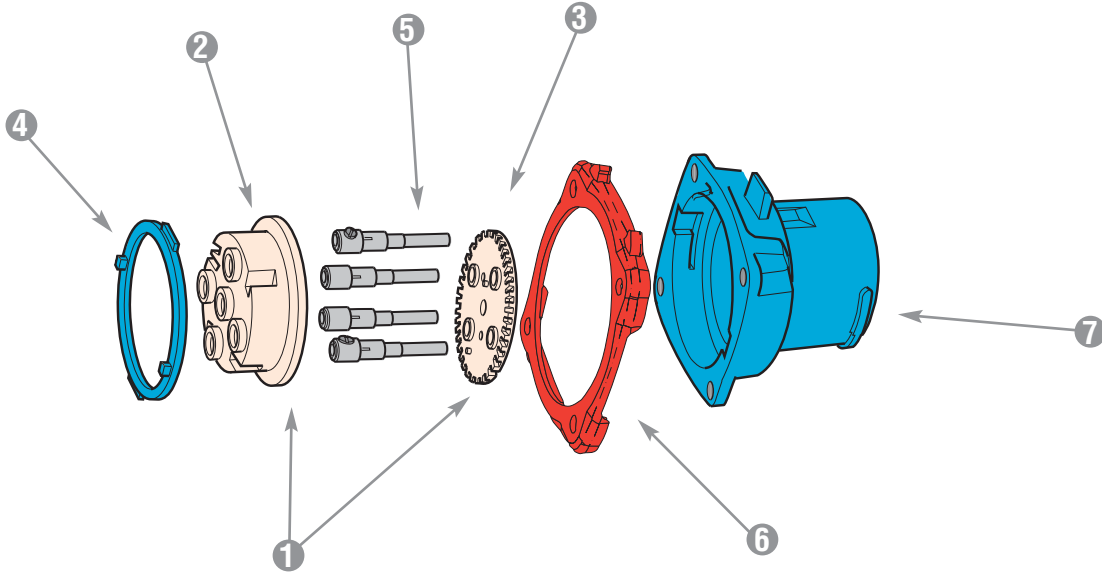

	DSN20 POLY	DSN30 POLY	DSN60 POLY	
1 = Plug Interior	61-1A010*	61-3A010*	61-6A010*	
2 = Interior Bottom	61-1A010-B	61-3A010-B	61-6A010-B	
3 = Interior Top	61-1A010-T*	61-3A010-T*	61-6A010-T*	
4 = Polyester Locking Ring	61-1A583	61-3A583	61-6A583	
5 = Plug Phase Contact (If plug does not have aux. contacts)	61-1A011	61-3A011-380	61-6A011	
5 = Plug Phase Contact (If plug has aux. contacts)	61-1A011	61-3A011	61-6A011	
5 = Plug Ground Contact	61-1A019	61-3A019	61-6A019	
6 = Color-Coded Voltage Gasket	<div style="display: flex; align-items: center;"> <div style="width: 15px; height: 10px; background-color: #0056b3; border-radius: 5px; margin-right: 5px;"></div> 208V </div> <div style="display: flex; align-items: center;"> <div style="width: 15px; height: 10px; background-color: #e69d00; border-radius: 5px; margin-right: 5px;"></div> 250V </div> <div style="display: flex; align-items: center;"> <div style="width: 15px; height: 10px; background-color: #c00000; border-radius: 5px; margin-right: 5px;"></div> 480V </div> <div style="display: flex; align-items: center;"> <div style="width: 15px; height: 10px; background-color: #333; border-radius: 5px; margin-right: 5px;"></div> 600V </div> <div style="display: flex; align-items: center;"> <div style="width: 15px; height: 10px; background-color: #e69d00; border-radius: 5px; margin-right: 5px;"></div> 125V </div>	61-1AB26	61-3AB26	61-6AB26
	61-1AC26	61-3AC26	61-6AC26	
	61-1AR26	61-3AR26	61-6AR26	
	-	61-3AN26	61-6AN26	
	61-1AC26	61-3AC26	61-6AC26	
7 = Plug Polyester Casing	61-1A014**	61-3A014**	61-6A014**	

* Voltage and phasing positions must be specified (5th, 6th & 7th digit of Part #) to duplicate your shutter and alignment notches.

** For appropriate labeling on a device, please specify voltage, phasing, and product type

Spare Parts

Female Configuration

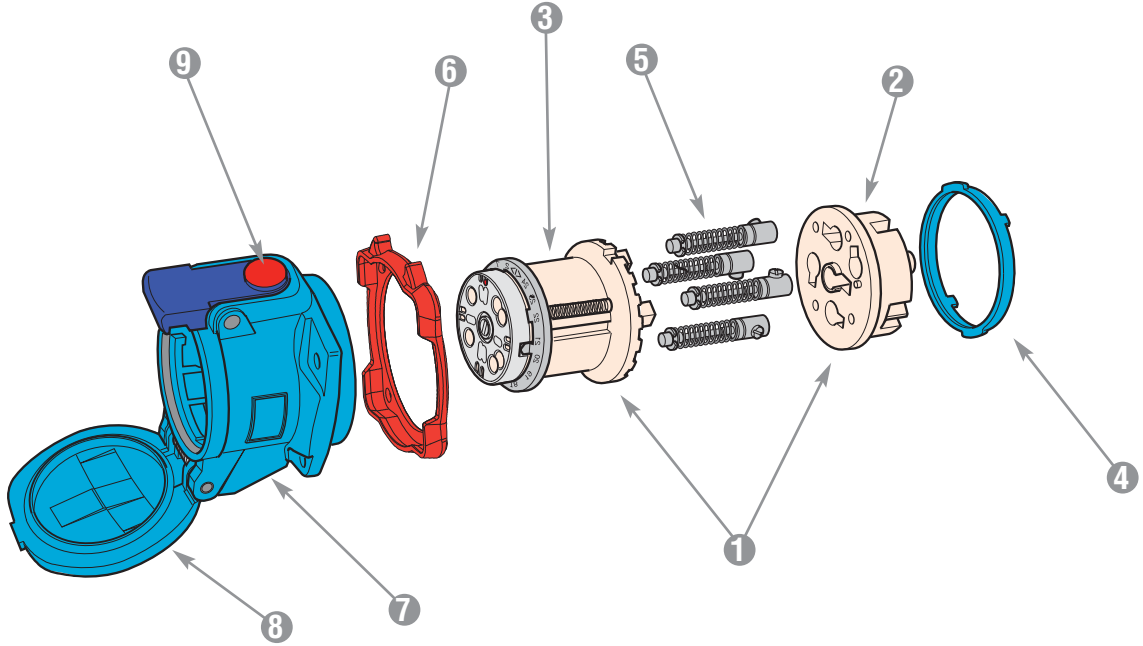

	DSN20 POLY	DSN30 POLY	DSN60 POLY
1 = Receptacle Interior	61-1A020*	61-3A020*	61-6A020*
2 = Interior Bottom	61-1A020-B	61-3A020-B	61-6A020-B
3 = Interior Top	61-1A020-T*	61-3A020-T*	61-6A020-T*
4 = Polyester Locking Ring	61-1A583	61-3A583	61-6A583
5 = Receptacle Phase Contact (If recp. does not have aux. contacts)	61-1A021	61-3A021-380	61-6A021
5 = Receptacle Phase Contact (If recp. has aux. contacts)	61-1A021	61-3A021	61-6A021
5 = Receptacle Ground Contact	61-1A029	61-3A029	61-6A029
6 = Color-Coded Voltage Gasket	<div style="display: flex; flex-direction: column; gap: 5px;"> <div>208V 61-1AB26</div> <div>250V 61-1AC26</div> <div>480V 61-1AR26</div> <div>600V -</div> <div>125V 61-1AC26</div> </div>	<div style="display: flex; flex-direction: column; gap: 5px;"> <div>61-3AB26</div> <div>61-3AC26</div> <div>61-3AR26</div> <div>61-3AN26</div> <div>61-3AC26</div> </div>	<div style="display: flex; flex-direction: column; gap: 5px;"> <div>61-6AB26</div> <div>61-6AC26</div> <div>61-6AR26</div> <div>61-6AN26</div> <div>61-6AC26</div> </div>
7 = Receptacle Polyester Casing	61-1A024**	61-3A024**	61-6A024**
8 = Lid Replacement Kit Polyester	61-1A125	61-3A125	61-6A125
9 = Pawl Replacement Kit Polyester	61-1A824	61-3A824	61-6A824

* Voltage and phasing positions must be specified (5th, 6th & 7th digit of Part #) to duplicate your shutter and alignment notches.

** For appropriate labeling on a device, please specify voltage, phasing, and product type.

For replacement parts contact customer service at 800.433.7642



Dimensions

Inlet – Provided in inches

Dimensions are for reference only and may change depending on accessories used. For precise dimensions contact Meltric Engineering.

Plug

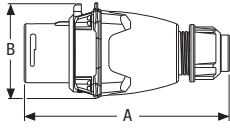

PRODUCT	A	B
DSN20	5.16	2.36
DSN30/DSN24	5.84	2.83
DSN60/DSN37	6.29	3.05

Inlet with connector

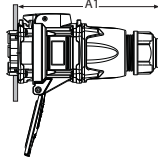

PRODUCT	A1
DSN20	5.63
DSN30/DSN24	6.78
DSN60/DSN37	7.32

Inlet

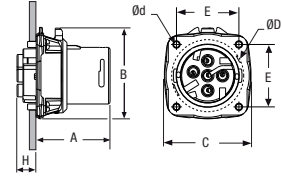

PRODUCT	A	B	C	E	H	Ød	ØD
DSN20	1.86	2.36	2.20	1.65	0.62	0.17	1.77
DSN30/DSN24	1.97	2.83	2.62	1.89	0.60	0.18	2.24
DSN60/DSN37	2.19	3.40	3.05	2.17	0.61	0.20	2.68

30° inclined inlet/angle with connector

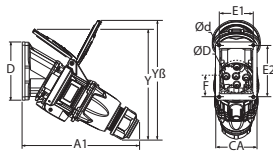

PRODUCT	A1	CA	D	E1	E2	F	Y	Yβ	Ød	ØD
DSN20	5.55	2.68	3.54	1.42	3.07	1.58	2.70	5.52	0.18	2.00
DSN30/DSN24	7.60	3.00	4.25	2.50	3.75	1.88	6.70	8.50	0.22	2.50
DSN60/DSN37	7.48	3.00	4.25	2.50	3.75	2.00	8.03	9.01	0.22	2.50

30° inlet/angle

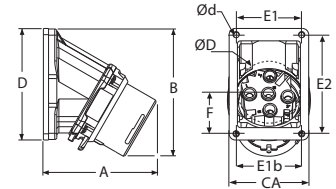

PRODUCT	A	B	CA	D	E1	E1b	E2	F	Ød	ØD
DSN20	3.13	4.91	2.68	3.54	1.42	2.20	3.07	1.58	0.18	2.00
DSN30/DSN24	3.66	4.63	3.00	4.25	2.50		3.75	1.88	0.22	2.50
DSN60/DSN37	4.00	4.82	3.00	4.25	2.50		3.75	2.00	0.22	2.50

30° inclined inlet/angle/ junction box with connector

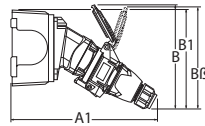

PRODUCT	A1	B	B1	Bβ
DSN20	7.80	6.38	6.06	
DSN30/DSN24	9.85	8.23	6.85	
DSN60/DSN37	9.73	7.81	7.13	9.06

inlet/angle/ metal junction box

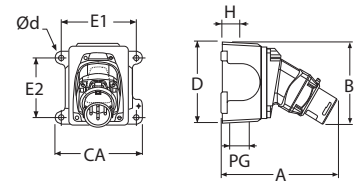

PRODUCT	A	B	CA	D	E1	E2	H	PG	Ød
DSN20	5.38	5.04	4.40	4.50	3.75	2.75	1.10	1.00	0.25
DSN30/DSN24	5.91	4.77	4.40	4.50	3.75	2.75	1.10	1.00	0.25
DSN60/DSN37	6.26	4.97	4.40	4.50	3.75	2.75	1.10	1.00	0.25

70° inclined inlet/wall box with connector

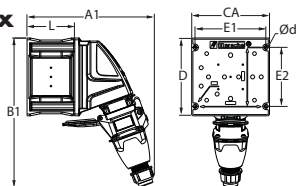

PRODUCT	A1	B1	CA	D	E1	E2	L	Ød
DSN20	8.11	9.41	5.04	5.04	4.57	3.78	3.07	0.26
DSN30/DSN24	8.70	10.55	5.04	5.04	4.57	3.72	3.07	0.26
DSN60/DSN37	9.52	12.60	6.69	6.69	6.14	5.43	3.07	0.26

Dimensions

Receptacle – Provided in inches

Dimensions are for reference only and may change depending on accessories used. For precise dimensions contact Meltrix Engineering.

connector

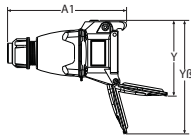

PRODUCT	A1	Y	YB
DSN20	5.41	3.21	5.30
DSN30/DSN24	6.74	4.46	7.13
DSN60/DSN37	7.18	5.36	8.18

receptacle with plug

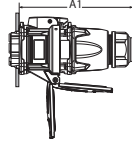

PRODUCT	A1
DSN20	5.63
DSN30/DSN24	6.78
DSN60/DSN37	7.32

receptacle

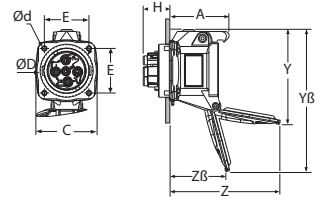

PRODUCT	A	C	E	H	Y	YB	Z	ZB	Ød	ØD
DSN20	2.12	2.20	1.65	0.98	3.50	5.19	4.05	2.09	0.17	2.00
DSN30/DSN24	2.87	2.89	1.89	0.65	4.65	7.01	5.07	2.17	0.18	2.24
DSN60/DSN37	3.12	2.27	2.17	0.73	5.32	8.12	5.73	2.43	0.19	2.68

30° inclined receptacle/angle with plug

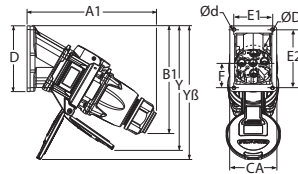

PRODUCT	A1	B1	CA	D	E1	E2	F	Y	YB	Ød	ØD
DSN20	5.52	7.48	2.68	3.54	1.42	3.07	1.58	7.00	7.10	0.18	2.00
DSN30/DSN24	7.60	6.73	3.00	4.25	2.50	3.75	1.88	6.70	8.50	0.22	2.50
DSN60/DSN37	8.24	7.01	3.00	4.25	2.50	3.75	2.00	8.06	9.02	0.22	2.50

30° receptacle/angle

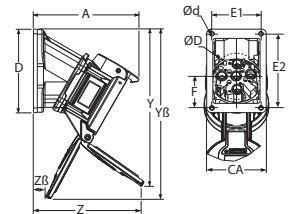

PRODUCT	A	CA	D	E1	E2	F	Y	YB	Ød	ØD
DSN20	3.84	2.68	3.54	1.42	3.07	1.58	7.13	7.10	0.18	2.00
DSN30/DSN24	4.76	3.00	4.25	2.50	3.75	1.88	7.50	8.35	0.22	2.50
DSN60/DSN37	5.23	3.00	4.25	2.50	3.75	2.00	7.99	9.04	0.22	2.50

30° inclined receptacle/angle/ junction box with plug

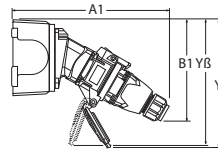

PRODUCT	A1	B1	Y	YB
DSN20	7.80	7.36	7.30	7.19
DSN30/DSN24	9.85	6.85	8.50	8.36
DSN60/DSN37	10.48	7.13	8.20	9.18

receptacle/angle/ metal junction box

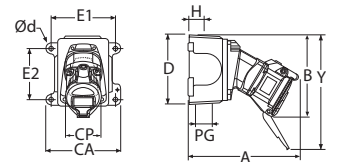

PRODUCT	A	B	CA	CP	D	E1	E2	H	PG	Y	Ød
DSN20	6.00	5.15	4.40	2.20	4.50	3.75	2.75	1.10	1.00	7.25	0.25
DSN30/DSN24	7.00	5.67	4.40	2.48	4.50	3.75	2.75	1.10	1.00	7.60	0.25
DSN60/DSN37	7.48	5.84	4.40	2.48	4.50	3.75	2.75	1.10	1.00	8.20	0.25

70° inclined receptacle/ wall box with plug

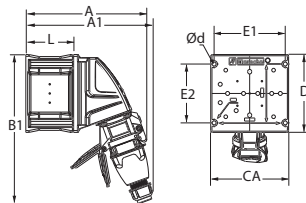

PRODUCT	A	A1	B1	CA	D	E1	E2	L	Ød
DSN20	7.25	8.11	9.41	5.04	5.04	4.57		3.07	0.26
DSN30/DSN24	8.16	8.70	10.55	5.04	5.04	4.57		3.07	0.26
DSN60/DSN37	9.36	9.52	12.60	6.69	6.69	6.14	5.43	3.07	0.26

DS



Features and Ratings	p. 36
DS20	p. 37
DS30	p. 39
DS60	p. 41
DS100C	p. 43
DS100	p. 45
DS200	p. 47
Spare parts	p. 49
Dimensions	p. 51



Switch rated plugs and receptacles

DS Series Deconnectors provide a useful combination of capacity and ruggedness. DS are often used to connect motors and welders in the metals, quarry, automotive, and mining industries. They are designed for applications requiring large wiring capacities. The DS's environmental rating is achieved as soon as the plug and receptacle are fully engaged, making them an excellent choice for outdoor applications where rainproof performance is required.

Main Advantages

- ▶ Switch & Hp rated (AC only)
- ▶ 65 kA to 100 kA short circuit rated*
- ▶ Up to 6 auxiliary contacts
- ▶ Amperage ratings up to 200A
- ▶ Metal or Poly construction

* See note under General Ratings on the next page

Highlighted Advantage

Simplify Compliance to
NFPA 70E & CSA Z462

See pgs 19-20 for
more information



Product Features

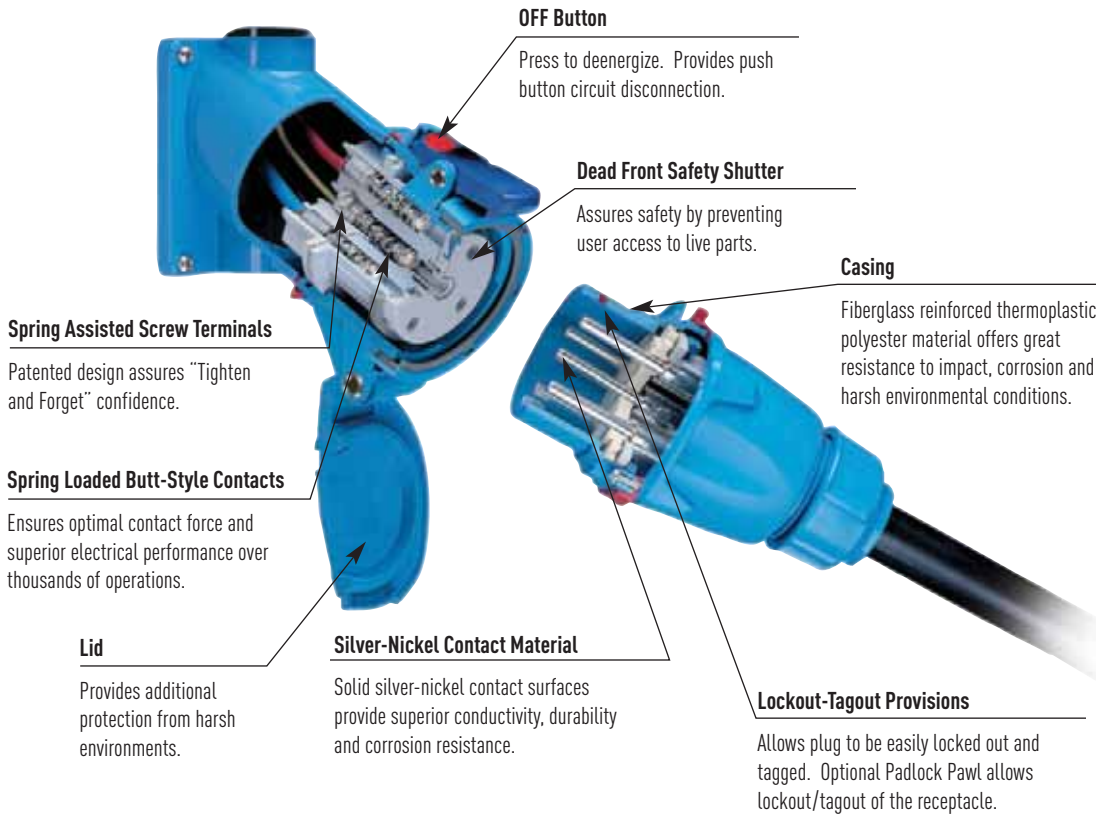

General Ratings

Amperage	20 to 200A
Voltage	600 VAC (480 VAC for DS200)
Frequency	50-400 Hz
Horsepower	1/2 to 25 hp
Short-Circuit (Make & Withstand)	65kA to 100kA*
Environmental	Type 3R, IP54/IP55**, NEMA 4X optional
Temperature	min -40°F/max 140°F

* DS20, 30, 60 & 100C are rated 100kA. Testing was performed with RK1 current limiting fuses sized at 400% of the highest full load motor ampacity associated with the devices hp rating.

** IP54 rated when receptacle and plug are mated, when not mated receptacle alone is IP55 rated provided that the lid is latched closed.

Listings

Category	UL	CSA	IEC
Plugs and Receptacles	UL 1682	C22.2 No. 182.1	60309-1
Branch Circuit Disconnect Switching (AC only)	UL Subject 2682 (Performance tests from UL 98)	UL Subject 2682	60947-3, AC22, AC23
Motor Circuit Disconnect Switching (AC only)	UL Subject 2682 (Performance tests from UL 508)	UL Subject 2682	

CE ratings available upon request

Highlighted Feature

Typical Device Labels

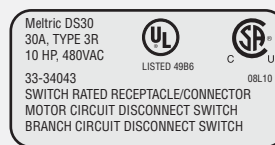

DS Deconnectors are UL & CSA rated for "motor circuit" and "branch circuit" disconnect switching – up to 25 hp and up to 200A

Operating Instructions



When the plug and receptacle are latched together, the circuit is connected.



Pressing the pawl causes the DECONTACTOR to break the circuit. The plug is ejected to its rest position; its contacts are now dead.



Rotating the 'dead' plug 30° counterclockwise closes the safety shutter and frees the plug to be withdrawn from the receptacle.



The plug and the receptacle are separated. The safety shutter prevents access to live parts.

5 To reconnect, insert plug into receptacle, rotate 30° clockwise, and apply insertion force.

DS20



DECONTACTOR™ – 20A

Switch Rated Plugs & Receptacles

Ratings

- Voltage**
600 VAC
- Switch Rating (AC Only)**
Branch Circuit & Motor Circuit Disconnect Switching
- Horsepower Ratings**

120V	1Ø	1/2 hp
208V	3Ø	3 hp
240V	3Ø	3 hp
480V	3Ø	3 hp
600V	3Ø	7 1/2 hp
- Short Circuit Rating**
100kA Close & Withstand
Testing was performed with RK1 current limiting fuses sized at 400% of the highest full load motor ampacity associated with the devices hp rating.
- Environmental Ratings**
Type 3R, IP54/IP55*
* IP54 when the plug & receptacle are mated. IP55 on the receptacle alone when the lid is latched closed.
- Temperature Range**
Min -40°F/Max 140°F
See pg 220 for temps below -15°F.
- Wiring Capacity**
Min 14 AWG Max 8 AWG
Aux Contact - Max 14 AWG
- Listings**
UL, CSA, IEC, CE*
* Contact Customer Service

Receptacle (female)



Don't forget to add installation accessories to your order

Inlet (male)



Voltage	Polarity	Part # Poly
120/208V	3P+N+G	33-14167
125V	1P+N+G	33-14075
125/250V	2P+N+G	33-14076
208V	2P+G	33-14162
208V	3P+G	33-14163
250V	2P+G	33-14072
250V	3P+G	33-14073
277V	1P+N+G	33-14045
277/480V	3P+N+G	33-14047
347/600V	3P+N+G	33-14147
480V	2P+G	33-14042
480V	3P+G	33-14043
600V	2P+G	33-14142
600V	3P+G	33-14143

Voltage	Polarity	Part # Poly
120/208V	3P+N+G	33-18167
125V	1P+N+G	33-18075
125/250V	2P+N+G	33-18076
208V	2P+G	33-18162
208V	3P+G	33-18163
250V	2P+G	33-18072
250V	3P+G	33-18073
277V	1P+N+G	33-18045
277/480V	3P+N+G	33-18047
347/600V	3P+N+G	33-18147
480V	2P+G	33-18042
480V	3P+G	33-18043
600V	2P+G	33-18142
600V	3P+G	33-18143

Other voltage configurations are available – contact customer service at 800.433.7642.

Main Options



Auxiliary/Pilot Contacts



Mushroom Pawl



Padlock Pawl



Closed Lid Configuration
Recommended for cord applications to keep lid tucked in to avoid damage.



See pgs 197-206 for detailed information on these options

Receptacle Options	Suffix #
With 2 Auxiliary/Pilot Contacts	Recept # - 972
Type 4X & closed lid configuration	Recept # - 4X
Straight Insertion	Recept # - A188
Self-Ejecting Connector Release	Recept # - 348-A188
Mushroom Pawl	Recept # - 375
Padlock Pawl	Recept # - 843
Padlockable Mushroom Pawl	Recept # - 375-843
Locking Mushroom Pawl	Recept # - 845
Metal Pawl (on poly receptacle)	Recept # - 824
Closed Lid Configuration	Recept # - NC
With Auxiliary Switch	Recept # - 270*

Notes: * Not UL/CSA Listed

Inlet Options	Suffix #
With 2 Auxiliary/Pilot Contacts	Inlet # - 972
Type 4X Watertightness	Inlet # - 4X
Self-Ejecting Plug Release	Inlet # - 338-A188
Straight Insertion	Inlet # - A188
With No Lockout Hole	Inlet # - A155
For Auxiliary Switch	Inlet # - NNF

Notes: * Order inlet with P+N+G configuration and receptacle with P+G configuration

DS20 Order Example:

To order 2 auxiliary/pilot contacts on an inlet and receptacle add **-972** to the part numbers.

DS20 Poly inlet 2P+G=33-18162-**972**

DS20 Poly receptacle 2P+G=33-14162-**972**

Appropriate accessory part numbers must also be included on the order.

Installation Accessories

Handles



Not NEMA 3R

NPT	Poly Handle	Cable Range	Nylon Handle	Neoprene Handle	Poly Handle w/Clamp & Bushing
1/2"	1PH12	.20 - .82	FH111	-	-
3/4"	1PH34	.32 - .88	-	31-111	-
1"	1PH1	.750 - .875	-	-	1PM514
1 1/4"	1PH114	.875 - 1.000	-	-	1PM516
		1.000 - 1.125	-	-	1PM518
		1.125 - 1.250	-	-	1PM520
		1.250 - 1.375	-	-	1PM522

Notes:

- Finger draw plates are recommended for easier connector closure on cord to cord assemblies.
- For available cord grips, see pgs 193-194.

Angles



Nylon 30° Angle	Metal 30° Angle	Metal Angle FS/FD Box 30°	Metal Straight Adapter
MP2	MA2	MAFS2	MS2

NPT Guidelines

Cable Range	NPT	Cable Range	NPT
.312 - .625	1/2"	.890 - 1.812	1 1/2"
.438 - .812	3/4"	1.190 - 2.438	2"
.660 - 1.000	1"	2.062 - 2.438	2 1/2"
.875 - 1.375	1 1/4"		

NPT sizes are determined by the cable diameter and third party cord grip.

Junction Boxes



28.7 in³



7.0 in³



83.5 in³

NPT	Metal Box	Metal Box with Nylon Angle	Poly* Conduit Entry	Poly 70°** Wall Box
1/2"	MB312	31-1A053-080-12	MC212	51-BA058
3/4"	MB334	31-1A053-080-34	MC234	51-BA058
1"	MB31	31-1A053-080-1	-	51-BA058
1 1/4"	MB3114	31-1A053-080-114	-	51-BA058

* For poly devices only
 ** 70° boxes are not drilled. Contact customer service if factory drilling is required.
 * Interior volume with receptacle installed.

Miscellaneous Accessories



* Set of Two (2)



For Male Devices Only



For Male Devices Only



Finger Drawplates	Protective Cap	Padlockable Plug Cap Poly	Inlet Spring-Loaded Cap	Screwdriver for Terminal Screws
FDP2	31-1A126	DS1PC	31-1A226	SD18**

* Recommended for cord to cord assembly applications, for easier connector closure
 ** Klein 608-3 1/8" cabinet tip screwdriver with 3" round shank

Order Example

A typical order should include an inlet part number, a receptacle part number **AND** the matching handles, angles or other required accessories.



Male Inlet with Handle (Plug)
33-18075 + FH111



Female Receptacle with Angle Adapter
33-14075 + MP2

DS30



DECONTACTOR™ – 30A

Switch Rated Plugs & Receptacles

Ratings

- Voltage**
600 VAC
- Switch Rating (AC Only)**
Branch Circuit & Motor Circuit Disconnect Switching
- Horsepower Ratings**

120V	1Ø	3/4 hp
240V	1Ø	2 hp
208V	3Ø	3 hp
240V	3Ø	3 hp
480V	3Ø	10 hp
600V	3Ø	10 hp
- Short Circuit Rating**
100kA Close & Withstand
Testing was performed with RK1 current limiting fuses sized at 400% of the highest full load motor ampacity associated with the devices hp rating.
- Environmental Ratings**
Type 3R, IP54/IP55*
* IP54 when the plug & receptacle are mated. IP55 on the receptacle alone when the lid is latched closed.
- Temperature Range**
Min -40°F/Max 140°F
See pg 220 for temps below -15°F.
- Wiring Capacity**
Min 14 AWG Max 6 AWG
Aux Contacts - Max 14 AWG
- Listings**
UL, CSA, IEC, CE*
* Contact Customer Service

Receptacle (female)



Don't forget to add installation accessories to your order

Inlet (male)



Voltage	Polarity	Part # Poly
120/208V	3P+N+G	33-34167
125V	1P+N+G	33-34075
125/250V	2P+N+G	33-34076
208V	2P+G	33-34162
208V	3P+G	33-34163
250V	2P+G	33-34072
250V	3P+G	33-34073
277V	1P+N+G	33-34045
277/480V	3P+N+G	33-34047
347/600V	3P+N+G	33-34147
480V	2P+G	33-34042
480V	3P+G	33-34043
600V	2P+G	33-34142
600V	3P+G	33-34143

Voltage	Polarity	Part # Poly
120/208V	3P+N+G	33-38167
125V	1P+N+G	33-38075
125/250V	2P+N+G	33-38076
208V	2P+G	33-38162
208V	3P+G	33-38163
250V	2P+G	33-38072
250V	3P+G	33-38073
277V	1P+N+G	33-38045
277/480V	3P+N+G	33-38047
347/600V	3P+N+G	33-38147
480V	2P+G	33-38042
480V	3P+G	33-38043
600V	2P+G	33-38142
600V	3P+G	33-38143

Other voltage configurations are available – contact customer service at 800.433.7642.

Main Options



Auxiliary/Pilot Contacts



Mushroom Pawl



Padlock Pawl



Closed Lid Configuration
Recommended for cord applications to keep lid tucked in to avoid damage.



See pgs 197-206 for detailed information on these options

Receptacle Options

Suffix

With 2 Auxiliary/Pilot Contacts	Receipt # - 972
With 3 Auxiliary/Pilot Contacts	Receipt # - 973*
With 4 Auxiliary/Pilot Contacts	Receipt # - 974*
Type 4X & closed lid configuration	Receipt # - 4X
Straight Insertion	Receipt # - A188
Self-Ejecting Connector Release	Receipt # - 348-A188
Mushroom Pawl	Receipt # - 375
Padlock Pawl	Receipt # - 843
Padlockable Mushroom Pawl	Receipt # - 375-843
Locking Mushroom Pawl	Receipt # - 845
Metal Pawl (on poly receptacle)	Receipt # - 824
Closed Lid Configuration	Receipt # - NC
With Auxiliary Switch	Receipt # - 270*

Inlet Options

Suffix

With 2 Auxiliary/Pilot Contacts	Inlet # - 972
With 3 Auxiliary/Pilot Contacts	Inlet # - 973*
With 4 Auxiliary/Pilot Contacts	Inlet # - 974*
Type 4X Watertightness	Inlet # - 4X
Self-Ejecting Plug Release	Inlet # - 338-A188
Straight Insertion	Inlet # - A188
With No Lockout Hole	Inlet # - A155
For Auxiliary Switch*	Inlet # - NNF

Notes: * Order inlet with P+N+G configuration and receptacle with P+G configuration

DS30 Order Example:

To order 2 auxiliary contacts on an inlet and receptacle add -972 to the part numbers.

DS30 Poly inlet 3P+G=33-38043-972

DS30 Poly receptacle 3P+G=33-34043-972

Appropriate accessory part numbers must also be included on the order.

Notes: * Not UL/CSA Listed

Installation Accessories

Handles



Not NEMA 3R

Makes connector closures easier

NPT	Poly Handle	Cable Range	Nylon Handle	Neoprene Handle	Poly Handle w/Clamp & Bushing	Poly Handle w/built in Draw Grips
1/2"	3PH12	.38 - 1.12	-	31-311	-	-
3/4"	3PH34	.39 - 1.18	FH311	-	-	FH311-473
1"	3PH1	.750 - .875	-	-	3PM514	-
1 1/4"	3PH114	.875 - 1.000	-	-	3PM516	-
		1.000 - 1.125	-	-	3PM518	-
		1.125 - 1.250	-	-	3PM520	-
		1.250 - 1.375	-	-	3PM522	-

- Notes:**
- Finger draw plates are recommended for easier connector closure on cord to cord assemblies.
 - For available cord grips, see pgs 193-194.

Angles



Nylon 30° Angle	Metal 30° Angle	Metal 70° Angle	Metal Angle FS/FD Box 30°	Metal Straight Adapter
MP3	MA3	89-3A027	MAFS3	MS3

NPT Guidelines

Cable Range	NPT	Cable Range	NPT
.312 - .625	1/2"	.890 - 1.812	1 1/2"
.438 - .812	3/4"	1.190 - 2.438	2"
.660 - 1.000	1"	2.062 - 2.438	2 1/2"
.875 - 1.375	1 1/4"		

NPT sizes are determined by the cable diameter and third party cord grip.

Junction Boxes



NPT	Metal Box	Metal Box with Nylon Angle	Poly* Conduit Entry	Poly 70°** Wall Box
1/2"	MB312	31-3A053-080-12	MC312	51-CA058
3/4"	MB334	31-3A053-080-34	MC334	51-CA058
1"	MB31	31-3A053-080-1	MC31	51-CA058
1 1/4"	MB3114	31-3A053-080-114	-	51-CA058

- * For poly devices only
 ** 70° boxes are not drilled. Contact customer service if factory drilling is required.
 * Interior volume with receptacle installed.

Miscellaneous Accessories



* Set of Two (2)

For Male Devices Only

For Male Devices Only

Finger Drawplates	Protective Cap	Padlockable Plug Cap Poly	Inlet Spring-Loaded Cap	Cord Grip with Mesh
FDP3	31-3A126	DS3PC	31-3A226	see pgs 193-194

* Recommended for cord to cord assembly applications, for easier connector closure

Order Example

A typical order should include an inlet part number, a receptacle part number **AND** the matching handles, angles or other required accessories.



Male Inlet with Handle (Plug)
33-38043 + FH311



Female Receptacle with Angle Adapter
33-34043 + MP3

DS60



DECONTACTOR™ – 60A

Switch Rated Plugs & Receptacles

Receptacle (female)

Inlet (male)



Don't forget to add installation accessories to your order



Ratings

- Voltage**
600 VAC
- Switch Rating (AC Only)**
Branch Circuit & Motor Circuit Disconnect Switching
- Horsepower Ratings**
 - 120V 1Ø 2 hp
 - 240V 1Ø 3 hp
 - 208V 3Ø 7 1/2 hp
 - 240V 3Ø 7 1/2 hp
 - 480V 3Ø 20 hp
 - 600V 3Ø 25 hp
- Short Circuit Rating**
100kA Close & Withstand
Testing was performed with RK1 current limiting fuses sized at 400% of the highest full load motor ampacity associated with the devices hp rating.
- Environmental Ratings**
Type 3R, IP54/IP55*
* IP54 when the plug & receptacle are mated. IP55 on the receptacle alone when the lid is latched closed.
- Temperature Range**
Min -40°F/Max 140°F
See pg 220 for temps below -15°F.
- Wiring Capacity**
Min 10 AWG Max 2 AWG
Aux Contacts - Max 14 AWG
- Listings**
UL, CSA, IEC, CE*
* Contact Customer Service

Voltage	Polarity	Part #	
		Poly	Metal
120/208V	3P+N+G	33-64167	37-64167
125V	1P+N+G	33-64075	37-64075
125/250V	2P+N+G	33-64076	37-64076
208V	2P+G	33-64162	37-64162
208V	3P+G	33-64163	37-64163
250V	2P+G	33-64072	37-64072
250V	3P+G	33-64073	37-64073
277V	1P+N+G	33-64045	37-64045
277/480V	3P+N+G	33-64047	37-64047
347/600V	3P+N+G	33-64147	37-64147
480V	2P+G	33-64042	37-64042
480V	3P+G	33-64043	37-64043
600V	2P+G	33-64142	37-64142
600V	3P+G	33-64143	37-64143

Voltage	Polarity	Part #	
		Poly	Metal
120/208V	3P+N+G	33-68167	37-68167
125V	1P+N+G	33-68075	37-68075
125/250V	2P+N+G	33-68076	37-68076
208V	2P+G	33-68162	37-68162
208V	3P+G	33-68163	37-68163
250V	2P+G	33-68072	37-68072
250V	3P+G	33-68073	37-68073
277V	1P+N+G	33-68045	37-68045
277/480V	3P+N+G	33-68047	37-68047
347/600V	3P+N+G	33-68147	37-68147
480V	2P+G	33-68042	37-68042
480V	3P+G	33-68043	37-68043
600V	2P+G	33-68142	37-68142
600V	3P+G	33-68143	37-68143

Other voltage configurations are available – contact customer service at 800.433.7642.

Main Options



Auxiliary/Pilot Contacts



Mushroom Pawl



Padlock Pawl



Closed Lid Configuration
Recommended for cord applications to keep lid tucked in to avoid damage.



See pgs 197-206 for detailed information on these options

Receptacle Options Suffix

With 2 Auxiliary/Pilot Contacts	Recept # - 972
With 3 Auxiliary/Pilot Contacts	Recept # - 263*
Type 4X & closed lid configuration	Recept # - 4X
Straight Insertion	Recept # - A188
Self-Ejecting Connector Release	Recept # - 348-A188
Mushroom Pawl	Recept # - 375
Padlock Pawl	Recept # - 843
Padlockable Mushroom Pawl	Recept # - 375-843
Locking Mushroom Pawl	Recept # - 845
Metal Pawl (on poly receptacle)	Recept # - 824
Closed Lid Configuration	Recept # - NC
With Auxiliary Switch	Recept # - 270**

Notes: * Not available for metal devices, not UL/CSA listed
** Not UL/CSA listed

Inlet Options Suffix

With 2 Auxiliary/Pilot Contacts	Inlet # - 972
With 3 Auxiliary/Pilot Contacts	Inlet # - 263*
Type 4X Watertightness	Inlet # - 4X
Self-Ejecting Plug Release	Inlet # - 338-A188
Straight Insertion	Inlet # - A188
With No Lockout Hole	Inlet # - A155
For Auxiliary Switch*	Inlet # - NNF

Notes: * Order inlet with P+N+G configuration and receptacle with P+G configuration

DS60 Order Example:

To order 2 auxiliary/pilot contacts on an inlet and receptacle add **-972** to the part numbers.

DS60 Poly inlet 3P+G=33-68043-**972**

DS60 Poly receptacle 3P+G=33-64043-**972**

Appropriate accessory part numbers must also be included on the order.

Installation Accessories

Unless indicated otherwise, accessories can be used with either poly or metal plugs and receptacles

Handles



NPT	Poly Handle	Metal* Handle	Cable Range	Nylon Handle	Neoprene Handle	Poly Handle w/Clamp & Bushing	Poly Handle w/built in Draw Grips
1/2"	6PH12	6H12	.50 - 1.25	-	31-611	-	-
3/4"	6PH34	6H34	.51 - 1.38	FH611	-	-	FH611-473
1"	6PH1	6H1	1.250 - 1.375	-	-	6PM622	-
1 1/4"	6PH114	6H114	1.438 - 1.562	-	-	6PM625	-
1 1/2"	6PH112	6H112	1.562 - 1.688	-	-	6PM627	-
			1.688 - 1.812	-	-	6PM629	-

Notes: • For available cord grips, see pgs 193-194. • For a guideline of NPT sizes based on cable ranges, see DS30 on pg 40.
* For metal devices only

Angles

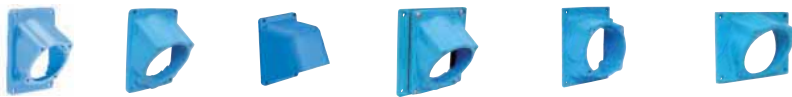

Nylon 30° Angle	Metal 30° Angle	Metal 70° Angle	Metal Angle+ Oversized 30°	Metal Straight Adapter	Metal Lateral Angle 30°
MP6	MA6	89-6A027	MA660	MS6	MAB6

* Mounts on oversize box only. Order with MB10 box. See page 46.

Junction Boxes

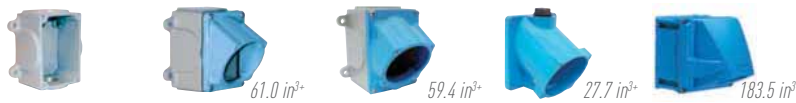

NPT	Metal Box	Metal Box with Nylon Angle	Metal Box with Metal Angle	Poly* Conduit Entry	Poly 70°** Wall Box
1/2"	-	-	-	MC612	51-DA058
3/4"	-	-	-	MC634	51-DA058
1"	MB61	31-6A053-080-1	39-6A053-080-1	MC61	51-DA058
1 1/4"	MB6114	31-6A053-080-114	39-6A053-080-114	MC6114	51-DA058
1 1/2"	MB6112	31-6A053-080-112	39-6A053-080-112	-	51-DA058
2"	MB62	31-6A053-080-2	39-6A053-080-2	-	51-DA058

* For poly devices only ** 70° boxes are not drilled. Contact customer service if factory drilling is required.
* Interior volume with receptacle installed.

Miscellaneous Accessories



Finger Drawplates	Protective Cap	Padlockable Plug Cap Poly	Padlockable Cap Aluminum	Inlet Spring-Loaded cap	Cord Grip with Mesh
FDP6	31-6A126	DS6PC	DS6MC	31-6A226	see pgs 193-194

Accessory Spotlight

Finger Drawplates



Finger drawplates are recommended for easier connector closure on cord to cord assemblies.

Order Example

A typical order should include an inlet part number, a receptacle part number **AND** the matching handles, angles or other required accessories.



Male Inlet with Handle (Plug)
33-68043 + FH611



Female Receptacle with Angle Adapter
33-64043 + MP6

DS100C



DECONTACTOR™ – 100A

Switch Rated Plugs & Receptacles

Ratings

- Voltage**
600 VAC
- Switch Ratings (AC Only)**
Branch Circuit & Motor Circuit
Disconnect Switching
- Horsepower Ratings**

120V	1Ø	2 hp
240V	1Ø	3 hp
208V	3Ø	7 1/2 hp
240V	3Ø	7 1/2 hp
480V	3Ø	20 hp
600V	3Ø	25 hp
- Short Circuit Rating**
100kA Close & Withstand
Testing was performed with RK1 current limiting fuses sized at 400% of the highest full load motor ampacity associated with the devices hp rating.
- Environmental Ratings**
Type 3R, IP54/IP55*
* IP54 when the plug & receptacle are mated. IP55 on the receptacle alone when the lid is latched closed.
- Temperature Range**
Min -40°F/Max 140°F
See pg 220 for temps below -15°F.
- Wiring Capacity**
Min 10 AWG Max 2 AWG
Aux Contacts - Max 14 AWG
- Listings**
UL, CSA, IEC, CE*
* Contact Customer Service

Receptacle (female)



Don't forget to add installation accessories to your order

Inlet (male)



Voltage	Polarity	Part #	
		Poly	Metal
120/208V	3P+N+G	33-64237-C-K16	37-64237-C-K16
125V	1P+N+G	33-64175-C-K07	37-64175-C-K07
125/250V	2P+N+G	33-64176-C-K07	37-64176-C-K07
208V	2P+G	33-64232-C-K16	37-64232-C-K16
208V	3P+G	33-64233-C-K16	37-64233-C-K16
250V	2P+G	33-64172-C-K07	37-64172-C-K07
250V	3P+G	33-64173-C-K07	37-64173-C-K07
277V	1P+N+G	33-64245-C-K04	37-64245-C-K04
277/480V	3P+N+G	33-64247-C-K04	37-64247-C-K04
347/600V	3P+N+G	33-64187-C-K14	37-64187-C-K14
480V	2P+G	33-64242-C-K04	37-64242-C-K04
480V	3P+G	33-64243-C-K04	37-64243-C-K04
600V	2P+G	33-64182-C-K14	37-64182-C-K14
600V	3P+G	33-64183-C-K14	37-64183-C-K14

Voltage	Polarity	Part #	
		Poly	Metal
120/208V	3P+N+G	33-68237-C-K16	37-68237-C-K16
125V	1P+N+G	33-68175-C-K07	37-68175-C-K07
125/250V	2P+N+G	33-68176-C-K07	37-68176-C-K07
208V	2P+G	33-68232-C-K16	37-68232-C-K16
208V	3P+G	33-68233-C-K16	37-68233-C-K16
250V	2P+G	33-68172-C-K07	37-68172-C-K07
250V	3P+G	33-68173-C-K07	37-68173-C-K07
277V	1P+N+G	33-68245-C-K04	37-68245-C-K04
277/480V	3P+N+G	33-68247-C-K04	37-68247-C-K04
347/600V	3P+N+G	33-68187-C-K14	37-68187-C-K14
480V	2P+G	33-68242-C-K04	37-68242-C-K04
480V	3P+G	33-68243-C-K04	37-68243-C-K04
600V	2P+G	33-68182-C-K14	37-68182-C-K14
600V	3P+G	33-68183-C-K14	37-68183-C-K14

Other voltage configurations are available – contact customer service at 800.433.7642.

Main Options



Auxiliary/Pilot Contacts



Mushroom Pawl



Padlock Pawl



Closed Lid Configuration

Recommended for cord applications to keep lid tucked in to avoid damage.



See pgs 197-206 for detailed information on these options

Receptacle Options

Suffix

With 2 Auxiliary/Pilot Contacts	Recept # - 972
With 3 Auxiliary/Pilot Contacts	Recept # - 263*
Type 4X & closed lid configuration	Recept # - 4X
Straight Insertion	Recept # - A188
Self-Ejecting Connector Release	Recept # - 348-A188
Mushroom Pawl	Recept # - 375
Padlock Pawl	Recept # - 843
Padlockable Mushroom Pawl	Recept # - 375-843
Locking Mushroom Pawl	Recept # - 845
Metal Pawl (on poly receptacle)	Recept # - 824
Closed Lid Configuration	Recept # - NC
With Auxiliary Switch	Recept # - 270**
Recess Plate	Recept # - 142

Notes: * Not available for metal devices, not UL/CSA listed
** Not UL/CSA listed

Inlet Options

Suffix

With 2 Auxiliary/Pilot Contacts	Inlet # - 972
With 3 Auxiliary/Pilot Contacts	Inlet # - 263*
Type 4X Watertightness	Inlet # - 4X
Self-Ejecting Plug Release	Inlet # - 338-A188
Straight Insertion	Inlet # - A188
With No Lockout Hole	Inlet # - A155
For Auxiliary Switch*	Inlet # - NNF

Notes: * Order inlet with P+N+G configuration and receptacle with P+G configuration

DS100C Order Example:

To order 2 auxiliary/pilot contacts on an inlet and receptacle add **-972** to the part numbers.

DS100C Poly inlet 3P+G=33-68243-C-K04-**972**

DS100C Poly receptacle 3P+G=33-64243-C-K04-**972**

Appropriate accessory part numbers must also be included on the order.

Installation Accessories

Unless indicated otherwise, accessories can be used with either poly or metal plugs and receptacles

Handles



NPT	Poly Handle	Metal* Handle	Cable Range	Nylon Handle	Neoprene Handle	Poly Handle w/Clamp & Bushing	Poly Handle w/built in Draw Grips
1/2"	6PH12	6H12	.50 - 1.25	-	31-611	-	-
3/4"	6PH34	6H34	.51 - 1.38	FH611	-	-	FH611-473
1"	6PH1	6H1	1.250 - 1.375	-	-	6PM622	-
1 1/4"	6PH114	6H114	1.438 - 1.562	-	-	6PM625	-
1 1/2"	6PH112	6H112	1.562 - 1.688	-	-	6PM627	-
			1.688 - 1.812	-	-	6PM629	-

- Notes:**
- Finger draw plates are recommended for easier connector closure on cord to cord assemblies.
 - For available cord grips, see pgs 193-194.
 - * For metal devices only

• For a guideline of NPT sizes based on cable ranges, see DS30 on pg 40.

Angles



Nylon 30° Angle	Metal 30° Angle	Metal 70° Angle	Metal Angle+ Oversized 30°	Metal Straight Adapter	Metal Lateral Angle 30°
MP6	MA6	89-6A027	MA660	MS6	MAB6

* Mounts on oversize box only. Order with MB10 box. See page 46.

Junction Boxes

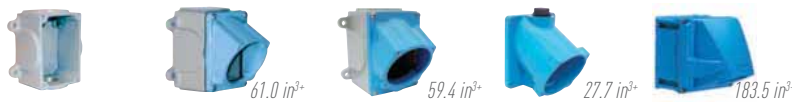

NPT	Metal Box	Metal Box with Nylon Angle	Metal Box with Metal Angle	Poly* Conduit Entry	Poly 70°** Wall Box
1/2"	-	-	-	MC612	51-DA058
3/4"	-	-	-	MC634	51-DA058
1"	MB61	31-6A053-080-1	39-6A053-080-1	MC61	51-DA058
1 1/4"	MB6114	31-6A053-080-114	39-6A053-080-114	MC6114	51-DA058
1 1/2"	MB6112	31-6A053-080-112	39-6A053-080-112	-	51-DA058
2"	MB62	31-6A053-080-2	39-6A053-080-2	-	51-DA058

* For poly devices only

** 70° boxes are not drilled. Contact customer service if factory drilling is required.

* Interior volume with receptacle installed.

Miscellaneous Accessories



Finger Drawplates	Protective Cap	Padlockable Cap	Inlet Spring-Loaded cap	Cord Grip with Mesh
FDP6	31-6A126	DS6MC	31-6A226	see pgs 193-194

Option Spotlight

Closed Lid Configuration



Normally closed lid configuration is recommended for cord to cord applications to keep the lid tucked in and avoid damage.

Order Example

A typical order should include an inlet part number, a receptacle part number **AND** the matching handles, angles or other required accessories.



Male Inlet with Handle (Plug)
33-68243-C-K04 + FH611



Female Receptacle with Angle Adapter
33-64243-C-K04 + MP6

DS100



DECONTACTOR™ – 100A

Switch Rated Plugs & Receptacles

Ratings

- **Voltage**
600 VAC
- **Switch Rating (AC Only)**
Branch Circuit
Disconnect Switching
- **Short Circuit Rating**
100kA Close & Withstand
Testing was performed with RK1
non-time delay fuses sized at 150%
of the devices rated ampacity.
- **Environmental Ratings**
Type 4X, IP66+IP67 (Poly Only)
Type 3R, IP54/IP55* (Metal Only)
* IP54 when the plug & receptacle are
mated. IP55 on the receptacle alone
when the lid is latched closed.
- **Temperature Range**
Min -40°F/Max 140°F
See pg 220 for temps below -15°F.
- **Wiring Capacity**
Min 8 AWG Max 2/0 AWG
Aux Contacts - Max 14 AWG
- **Listings**
UL, CSA, IEC, CE*

Receptacle (female)



Inlet (male)

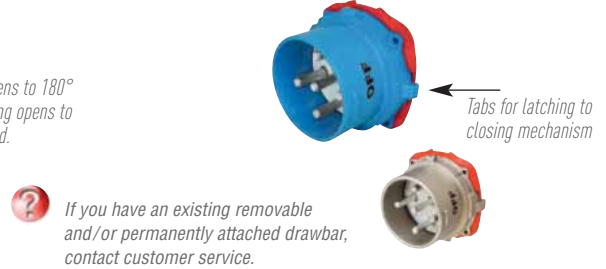

Voltage	Polarity	Part #	
		Poly	Metal
120/208V	3P+N+G*	33-94167	37-94167
125V	1P+N+G	33-94075	37-94075
125/250V	2P+N+G	33-94076	37-94076
208V	2P+G	33-94162	37-94162
208V	3P+G	33-94163	37-94163
250V	2P+G	33-94072	37-94072
250V	3P+G	33-94073	37-94073
277V	1P+N+G	33-94045	37-94045
277/480V	3P+N+G*	33-94047	37-94047
347/600V	3P+N+G*	33-94147	37-94147
480V	2P+G	33-94042	37-94042
480V	3P+G	33-94043	37-94043
600V	2P+G	33-94142	37-94142
600V	3P+G	33-94143	37-94143

Voltage	Polarity	Part #	
		Poly	Metal
120/208V	3P+N+G*	33-98167	37-98167
125V	1P+N+G	33-98075	37-98075
125/250V	2P+N+G	33-98076	37-98076
208V	2P+G	33-98162	37-98162
208V	3P+G	33-98163	37-98163
250V	2P+G	33-98072	37-98072
250V	3P+G	33-98073	37-98073
277V	1P+N+G	33-98045	37-98045
277/480V	3P+N+G*	33-98047	37-98047
347/600V	3P+N+G*	33-98147	37-98147
480V	2P+G	33-98042	37-98042
480V	3P+G	33-98043	37-98043
600V	2P+G	33-98142	37-98142
600V	3P+G	33-98143	37-98143

Other voltage configurations are available – contact customer service at 800.433.7642.

Main Options

- Auxiliary/Pilot Contacts
- Mushroom Pawl
- Padlock Pawl
- Closed Lid Configuration
Recommended for cord applications to keep lid tucked in to avoid damage.

See pgs 197-206 for detailed information on these options

Receptacle Options

Suffix

With 2 Auxiliary/Pilot Contacts	Recept # - 262
With 3 Auxiliary/Pilot Contacts	Recept # - 263*
With 4 Auxiliary/Pilot Contacts	Recept # - 264*
With 5 Auxiliary/Pilot Contacts	Recept # - 975*
With 6 Auxiliary/Pilot Contacts	Recept # - 976*
Type 4X & closed lid configuration	Recept # - 4X ⁱ
Straight Insertion	Recept # - A188
Self-Ejecting Connector Release	Recept # - 348-A188
Mushroom Pawl	Recept # - 375
Padlock Pawl	Recept # - 843
Padlockable Mushroom Pawl	Recept # - 375-843
Locking Mushroom Pawl	Recept # - 845
Metal Pawl (on poly receptacle)	Recept # - 824
180° Opening Lid	Recept # - 180 ⁺⁺
Closed Lid Configuration	Recept # - NC
With Auxiliary Switch	Recept # - 270 ⁺⁺⁺

- Notes:** + DS100 devices with 3 or more aux/pilot contacts are not UL/CSA listed
 ++ Required when mating to rigid mounted male inlet
 +++ Not UL/CSA listed
ⁱ Metal devices only

Inlet Options

Suffix

With 2 Auxiliary/Pilot Contacts	Inlet # - 262
With 3 Auxiliary/Pilot Contacts	Inlet # - 263*
With 4 Auxiliary/Pilot Contacts	Inlet # - 264*
With 5 Auxiliary/Pilot Contacts	Inlet # - 975*
With 6 Auxiliary/Pilot Contacts	Inlet # - 976*
Type 4X Watertightness	Inlet # - 4X ⁱ
Self-Ejecting Plug Release	Inlet # - 338-A188
Straight Insertion	Inlet # - A188
With No Lockout Hole	Inlet # - A155
For Auxiliary Switch*	Inlet # - NNF

Notes: * Order inlet with P+N+G configuration and receptacle with P+G configuration

DS100 Order Example:

To order 2 auxiliary/pilot contacts on an inlet and receptacle add **-262** to the part numbers.

DS100 Poly inlet 3P+G=33-98043-262

DS100 Poly receptacle 3P+G=33-94043-262

Appropriate accessory part numbers must also be included on the order.

Installation Accessories

Unless indicated otherwise, accessories can be used with either poly or metal plugs and receptacles

Handles



IP 66/67

NPT	Poly Handle	Metal* Handle
3/4"	9PH34	9H34
1"	9PH1	9H1
1 1/4"	9PH114	9H114
1 1/2"	9PH112	9H112
2"	9PH2	9H2

Cable Range	Santoprene™ Handle	Poly Handle w/Clamp & Bushing
.70 - 1.00	65-9A013-D25	-
.984 - 1.377	65-9A013-D35	-
1.250 - 1.375	-	9PM622
1.377 - 1.771	65-9A013-D45	-
1.438 - 1.562	-	9PM625
1.562 - 1.688	-	9PM627
1.688 - 1.812	-	9PM629

- Notes:**
- Finger draw plates are recommended for easier connector closure on cord to cord assemblies.
 - For a guideline of NPT sizes based on cable ranges, see DS30 on pg 40.
 - For available cord grips, see pgs 193-194.
 - * For metal devices only

Angles



Nylon 30° Angle	Metal 30° Angle	Metal 70° Angle	Metal Angle+ Oversized 30°	Metal Straight Adapter
MP10	MA10	89-9A027	MA110	MS10

* Mounts on oversize box only. Order with MB220 box. See page 48.

Junction Boxes



108.7 in³

111.8 in³

NPT	Metal Box	Metal Box with Nylon Angle	Metal Box with Metal Angle
1 1/4"	MB10114	31-9A053-080-114	39-9A053-080-114
1 1/2"	MB10112	31-9A053-080-112	39-9A053-080-112
2"	MB102	31-9A053-080-2	39-9A053-080-2
2 1/2"	MB10212	31-9A053-080-212	39-9A053-080-212

* Interior volume with receptacle installed.

Miscellaneous Accessories



For Male Devices Only



For Male Devices Only



Protective Cap	Padlockable Cap Aluminum	Cord Grip with Mesh
31-9A126	DS9MC	see pgs 193-194

Order Example

A typical order should include an inlet part number, a receptacle part number **AND** the matching handles, angles or other required accessories.



Male Inlet with Handle (Plug)
37-98043 + 65-9A013-D25



Female Receptacle with Angle Adapter
37-94043 + MA10

Feature Spotlight – Easy Closing Mechanism

A new and simplified closing mechanism is now standard on the DS100 and DS200 plugs and receptacles. This compact mechanism enables easy connection of the plug to the receptacle.

Notes: After connection, the mechanism must be released to allow disconnection of the device.



The plug is partially inserted, clamps are placed around tab, ready to pull the plug into the receptacle



The handles are pushed down, the plug is fully drawn into the receptacle

DS200



DECONTACTOR™ – 200A

Switch Rated Plugs & Receptacles

Ratings

- Voltage**
480 VAC
- Switch Rating (AC Only)**
Branch Circuit
Disconnect Switching
- Short Circuit Rating**
65kA Close & Withstand
Testing was performed with RK5 time delay fuses sized at 100% of the devices rated ampacity.
- Environmental Ratings**
Type 3R, IP54/IP55*
* IP54 when the plug & receptacle are mated. IP55 on the receptacle alone when the lid is latched closed.
- Temperature Range**
Min -40°F/Max 140°F
See pg 220 for temps below -15°F.
- Wiring Capacity**
Min 4 AWG Max 3/0 AWG
Aux Contacts - Max 14 AWG
* 4/0 is available upon request by adding suffix "A06" to the inlet or receptacle.
- Listings**
UL, CSA, IEC, CE*
* Contact Customer Service

Receptacle (female)



Inlet (male)



Voltage	Polarity	Part # Metal
120/208V	3P+N+G	37-24167
125V	1P+N+G	37-24075
125/250V	2P+N+G	37-24076
208V	2P+G	37-24162
208V	3P+G	37-24163
250V	2P+G	37-24072
250V	3P+G	37-24073
277V	1P+N+G	37-24045
277/480V	3P+N+G	37-24047
347/600V	3P+N+G	*
480V	2P+G	37-24042
480V	3P+G	37-24043
600V	2P+G	*
600V	3P+G	*

Voltage	Polarity	Part # Metal
120/208V	3P+N+G	37-28167
125V	1P+N+G	37-28075
125/250V	2P+N+G	37-28076
208V	2P+G	37-28162
208V	3P+G	37-28163
250V	2P+G	37-28072
250V	3P+G	37-28073
277V	1P+N+G	37-28045
277/480V	3P+N+G	37-28047
347/600V	3P+N+G	*
480V	2P+G	37-28042
480V	3P+G	37-28043
600V	2P+G	*
600V	3P+G	*

* See DR250 for 600V device page 151

Main Options



Auxiliary/Pilot Contacts



Mushroom Pawl



Padlock Pawl



Closed Lid Configuration
Recommended for cord applications to keep lid tucked in to avoid damage.



See pgs 197-206 for detailed information on these options

Receptacle Options

Suffix

With 2 Auxiliary/Pilot Contacts	Recept # - 172
With 3 Auxiliary/Pilot Contacts	Recept # - 173+
With 4 Auxiliary/Pilot Contacts	Recept # - 174+
With 5 Auxiliary/Pilot Contacts	Recept # - 175+
Type 4X & closed lid configuration	Recept # - 4X
Straight Insertion	Recept # - A188
Self-Ejecting Connector Release	Recept # - 348-A188
Mushroom Pawl	Recept # - 375
Padlock Pawl	Recept # - 843
Padlockable Mushroom Pawl	Recept # - 375-843
Locking Mushroom Pawl	Recept # - 845
180° Opening Lid	Recept # - 180++
Closed Lid Configuration	Recept # - NC
With Auxiliary Switch	Recept # - 270+++

Notes: + DS200 devices with 3 or more aux/pilot contacts are not UL/CSA listed
++ Required when mating to rigid mounted male inlet
+++ Not UL/CSA listed

Inlet Options

Suffix

With 2 Auxiliary/Pilot Contacts	Inlet # - 172
With 3 Auxiliary/Pilot Contacts	Inlet # - 173+
With 4 Auxiliary/Pilot Contacts	Inlet # - 174+
With 5 Auxiliary/Pilot Contacts	Inlet # - 175+
Type 4X Watertightness	Inlet # - 4X
Self-Ejecting Plug Release	Inlet # - 338-A188
Straight Insertion	Inlet # - A188
With No Lockout Hole	Inlet # - A155
For Auxiliary Switch*	Inlet # - NNF

Notes: * Order inlet with P+N+G configuration and receptacle with P+G configuration

DS200 Order Example:

To order 2 auxiliary contacts on an inlet and receptacle add -172 to the part numbers.

DS200 Metal inlet 3P+G=37-28043-172

DS200 Metal receptacle 3P+G=37-24043-172

Appropriate accessory part numbers must also be included on the order.

Installation Accessories

Handles



IP 66/67

NPT	Poly Handle	Metal* Handle
1"	-	2H1
1 1/4"	-	2H114
1 1/2"	2PH112	2H112
2"	2PH2	2H2
2 1/2"	2PH212	2H212

Cable Range	Santoprene™ Handle
.984 - 1.377	35-2A013-D35
1.377 - 1.771	35-2A013-D45
1.771 - 1.929	35-2A013-D49

Notes: • For available cord grips, see pgs 193-194.

NPT Guidelines

Cable Range	NPT
.312 - .625	1/2"
.438 - .812	3/4"
.660 - 1.000	1"
.875 - 1.375	1 1/4"
.890 - 1.812	1 1/2"
1.190 - 2.438	2"
2.062 - 2.438	2 1/2"

NPT sizes are determined by the cable diameter and third party cord grip.

Angles



Metal 60° Angle	Metal Angle+ Oversized 45°	Metal Straight Adapter
MA20	MA220	MS20

* Mounts on oversize box only.

Junction Boxes



248.4 in³*

NPT	Metal Box	Metal Box Oversized	Metal Box with Metal Angle
1 1/2"	MB20112	-	39-2A053-080-112
2"	MB202	-	39-2A053-080-2
2 1/2"	MB20212	MB22212	39-2A053-080-212

* Interior volume with receptacle installed.

Miscellaneous Accessories



For Male Devices Only



For Male Devices Only

Protective Cap	Padlockable Cap Aluminum
31-2A126	DS2MC

Feature Spotlight – Easy Closing Mechanism

A new and simplified closing mechanism is now standard on the DS100 and DS200 plugs and receptacles. This compact mechanism enables easy connection of the plug to the receptacle.

Notes: After connection, the mechanism must be released to allow disconnection of the device.



The plug is partially inserted, clamps are placed around tab, ready to pull the plug into the receptacle.



The handles are pushed down, the plug is fully drawn into the receptacle.

Order Example

A typical order should include an inlet part number, a receptacle part number **AND** the matching handles, angles or other required accessories.



Male Inlet with Handle (Plug)
37-28043 + 35-2A013-D35



Female Receptacle with Angle Adapter
37-24043 + MA20



Spare Parts Male Configuration

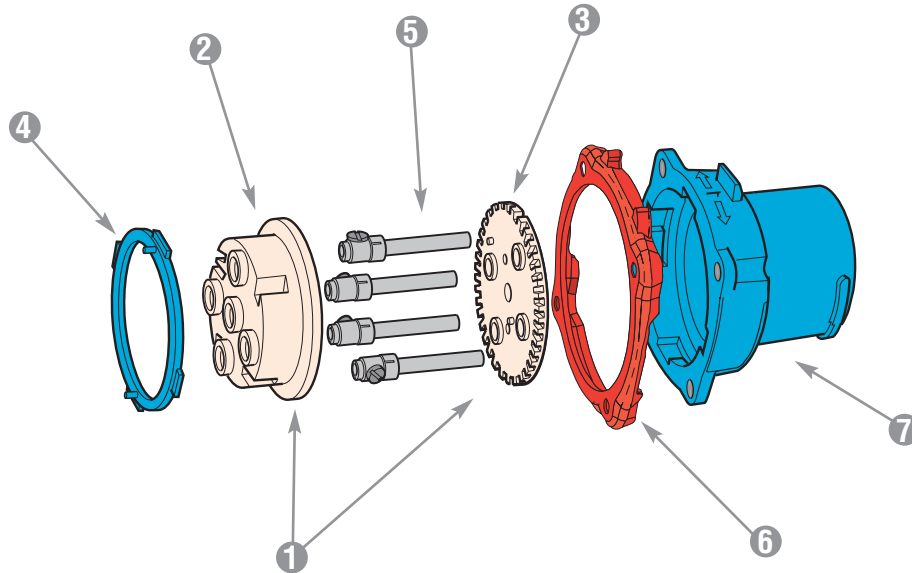

	DS20 POLY	DS30 POLY	DS60 POLY	DS60 METAL	DS100C POLY	DS100C METAL	DS100 POLY	DS100 METAL	DS200 METAL
1 = Plug Interior***	31-1A010*	31-3A010*	31-6A010*	31-6A010*	31-6A010-C*	31-6A010-C*	61-9A010*	69-9A010*	39-2A010*
1 = Plug Interior with Ground Contacts***	-	-	-	39-6A110*	-	39-6A110-C*	-	69-9A110*	39-2A110*
2 = Interior Bottom***	31-1A010-B	31-3A010-B	31-6A010-B	31-6A010-B	31-6A010-C-B	31-6A010-C-B	61-9A551	69-9A551	39-2A010-B
3 = Interior Top***	31-1A010-T*	31-3A010-T*	31-6A010-T*	31-6A010-T*	31-6A010-C-T*	31-6A010-C-T*	61-9A010-T*	69-9A010-T*	39-2A010-T*
4 = Polyester Locking Ring	31-1A583	31-3A583	31-6A583	-	31-6A583	-	31-9A583	-	-
4 = Metal Locking Ring	-	-	-	39-6A583	-	39-6A583	-	39-9A583	39-2A583
5 = Plug Phase Contact (If no aux. contacts)	31-1A011-380	31-3A011-380	31-6A011	31-6A011	31-6A011-C	31-6A011-C	61-9A011	61-9A011	39-2A011
5 = Plug Phase Contact (If plug has aux. contacts)	31-1A011	31-3A011-380	31-6A011	31-6A011	31-6A011-C	31-6A011-C	61-9A011	61-9A011	39-2A011
5 = Plug Ground Contact	31-1A019	31-3A019	31-6A019	39-6A019	31-6A019-C	39-6A019-C	61-9A019	69-9A019	39-2A019
6 = Color-Coded Voltage Gasket	<div style="background-color: #004a7c; color: white; border-radius: 5px; padding: 2px;">208V</div> 31-1AB26	<div style="background-color: #004a7c; color: white; border-radius: 5px; padding: 2px;">208V</div> 31-3AB26	<div style="background-color: #004a7c; color: white; border-radius: 5px; padding: 2px;">208V</div> 31-6AB26	<div style="background-color: #004a7c; color: white; border-radius: 5px; padding: 2px;">208V</div> 31-6AB26	<div style="background-color: #004a7c; color: white; border-radius: 5px; padding: 2px;">208V</div> 31-6AB26	<div style="background-color: #004a7c; color: white; border-radius: 5px; padding: 2px;">208V</div> 31-6AB26	<div style="background-color: #004a7c; color: white; border-radius: 5px; padding: 2px;">208V</div> 31-9AB26	<div style="background-color: #004a7c; color: white; border-radius: 5px; padding: 2px;">208V</div> 31-9AB26	<div style="background-color: #004a7c; color: white; border-radius: 5px; padding: 2px;">208V</div> 39-2AB26
	<div style="background-color: #ff9900; color: white; border-radius: 5px; padding: 2px;">250V</div> 31-1AC26	<div style="background-color: #ff9900; color: white; border-radius: 5px; padding: 2px;">250V</div> 31-3AC26	<div style="background-color: #ff9900; color: white; border-radius: 5px; padding: 2px;">250V</div> 31-6AC26	<div style="background-color: #ff9900; color: white; border-radius: 5px; padding: 2px;">250V</div> 31-6AC26	<div style="background-color: #ff9900; color: white; border-radius: 5px; padding: 2px;">250V</div> 31-6AC26	<div style="background-color: #ff9900; color: white; border-radius: 5px; padding: 2px;">250V</div> 31-6AC26	<div style="background-color: #ff9900; color: white; border-radius: 5px; padding: 2px;">250V</div> 31-9AC26	<div style="background-color: #ff9900; color: white; border-radius: 5px; padding: 2px;">250V</div> 31-9AC26	<div style="background-color: #ff9900; color: white; border-radius: 5px; padding: 2px;">250V</div> 39-2AC26
	<div style="background-color: #ff0000; color: white; border-radius: 5px; padding: 2px;">480V</div> 31-1AR26	<div style="background-color: #ff0000; color: white; border-radius: 5px; padding: 2px;">480V</div> 31-3AR26	<div style="background-color: #ff0000; color: white; border-radius: 5px; padding: 2px;">480V</div> 31-6AR26	<div style="background-color: #ff0000; color: white; border-radius: 5px; padding: 2px;">480V</div> 31-6AR26	<div style="background-color: #ff0000; color: white; border-radius: 5px; padding: 2px;">480V</div> 31-6AR26	<div style="background-color: #ff0000; color: white; border-radius: 5px; padding: 2px;">480V</div> 31-6AR26	<div style="background-color: #ff0000; color: white; border-radius: 5px; padding: 2px;">480V</div> 31-9AR26	<div style="background-color: #ff0000; color: white; border-radius: 5px; padding: 2px;">480V</div> 31-9AR26	<div style="background-color: #ff0000; color: white; border-radius: 5px; padding: 2px;">480V</div> 39-2AR26
	<div style="background-color: #000000; color: white; border-radius: 5px; padding: 2px;">600V</div> 31-1AN26	<div style="background-color: #000000; color: white; border-radius: 5px; padding: 2px;">600V</div> 31-3AN26	<div style="background-color: #000000; color: white; border-radius: 5px; padding: 2px;">600V</div> 31-6AN26	<div style="background-color: #000000; color: white; border-radius: 5px; padding: 2px;">600V</div> 31-6AN26	<div style="background-color: #000000; color: white; border-radius: 5px; padding: 2px;">600V</div> 31-6AN26	<div style="background-color: #000000; color: white; border-radius: 5px; padding: 2px;">600V</div> 31-6AN26	<div style="background-color: #000000; color: white; border-radius: 5px; padding: 2px;">600V</div> 31-9AN26	<div style="background-color: #000000; color: white; border-radius: 5px; padding: 2px;">600V</div> 31-9AN26	<div style="background-color: #000000; color: white; border-radius: 5px; padding: 2px;">600V</div> 39-2AN26
	<div style="background-color: #ff9900; color: white; border-radius: 5px; padding: 2px;">125V</div> 31-1AC26	<div style="background-color: #ff9900; color: white; border-radius: 5px; padding: 2px;">125V</div> 31-3AC26	<div style="background-color: #ff9900; color: white; border-radius: 5px; padding: 2px;">125V</div> 31-6AC26	<div style="background-color: #ff9900; color: white; border-radius: 5px; padding: 2px;">125V</div> 31-6AC26	<div style="background-color: #ff9900; color: white; border-radius: 5px; padding: 2px;">125V</div> 31-6AC26	<div style="background-color: #ff9900; color: white; border-radius: 5px; padding: 2px;">125V</div> 31-6AC26	<div style="background-color: #ff9900; color: white; border-radius: 5px; padding: 2px;">125V</div> 31-9AC26	<div style="background-color: #ff9900; color: white; border-radius: 5px; padding: 2px;">125V</div> 31-9AC26	<div style="background-color: #ff9900; color: white; border-radius: 5px; padding: 2px;">125V</div> 39-2AC26
7 = Plug Polyester Casing	31-1A014**	31-3A014**	31-6A014**	-	31-6A014**	-	31-9A014**	-	-
7 = Plug Metal Casing	-	-	-	39-6A014**	-	39-6A014**	-	39-9A014**	39-2A014**
Ground Ring (Not Shown)	-	-	-	39-6A523	-	39-6A523	-	39-9A523P	39-2A523

* Voltage and phasing positions must be specified (5th, 6th & 7th digit of Part #) to duplicate your shutter and alignment notches.

** For appropriate labeling on a device, please specify voltage, phasing, and product type

***For interiors with pilot contacts, contact Customer Service for part numbers.

Spare Parts

Female Configuration

DS

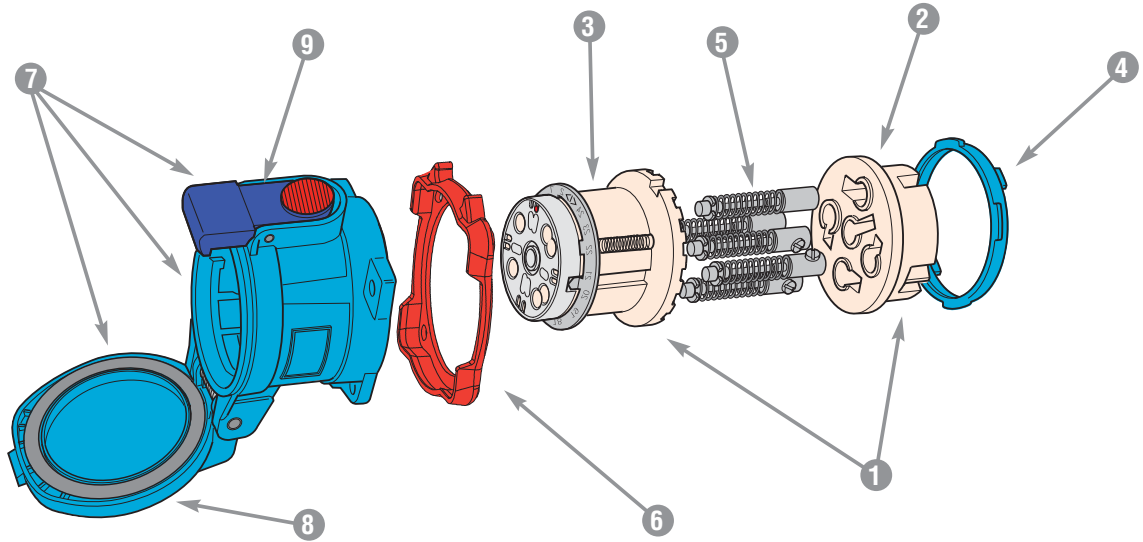

	DS20 POLY	DS30 POLY	DS60 POLY	DS60 METAL	DS100C POLY	DS100C METAL	DS100 POLY	DS100 METAL	DS200 METAL
1 = Receptacle Interior***	31-1A020*	31-3A020*	31-6A020*	31-6A020*	31-6A020-C*	31-6A020-C*	61-9A020*	69-9A020*	39-2A020*
1 = Recept Interior with Ground Contacts***	-	-	-	39-6A220*	-	39-6A220-C*	-	69-9A220*	39-2A220*
2 = Interior Bottom***	31-1A020-B	31-3A020-B	31-6A020-B	31-6A020-B	31-6A020-C-B	31-6A020-C-B	61-9A552	69-9A552	39-2A020-B
3 = Interior Top***	31-1A020-T*	31-3A020-T*	31-6A020-T*	31-6A020-T*	31-6A020-C-T*	31-6A020-C-T*	61-9A020-T*	69-9A020-T*	39-2A020-T*
4 = Polyester Locking Ring	31-1A583	31-3A583	31-6A583	-	31-6A583	-	31-9A583	-	-
4 = Metal Locking Ring	-	-	-	39-6A583	-	39-6A583	-	39-9A583	39-2A583
5 = Recept Phase Contact (If no aux. contacts)	31-1A021-380	31-3A021-380	31-6A021	31-6A021	31-6A021-C	31-6A021-C	61-9A021	61-9A021	39-2A021
5 = Recept Phase Contact (If plug has aux. contacts)	31-1A021	31-3A021-380	31-6A021	31-6A021	31-6A021-C	31-6A021-C	61-9A021	61-9A021	39-2A021
6 = Recept Ground Contact	31-1A029	31-3A029	31-6A029	39-6A029	31-6A029-C	39-6A029-C	61-9A029	69-9A029	39-2A029
6 = Color-Coded Voltage Gasket	208V 31-1AB26 250V 31-1AC26 480V 31-1AR26 600V 31-1AN26 125V 31-1AC26	31-3AB26 31-3AC26 31-3AR26 31-3AN26 31-3AC26	31-6AB26 31-6AC26 31-6AR26 31-6AN26 31-6AC26	31-6AB26 31-6AC26 31-6AR26 31-6AN26 31-6AC26	31-6AB26 31-6AC26 31-6AR26 31-6AN26 31-6AC26	31-6AB26 31-6AC26 31-6AR26 31-6AN26 31-6AC26	31-9AB26 31-9AC26 31-9AR26 31-9AN26 31-9AC26	31-9AB26 31-9AC26 31-9AR26 31-9AN26 31-9AC26	39-2AB26 39-2AC26 39-2AR26 39-2AN26 39-2AC26
7 = Receptacle Polyester Casing with Lid	31-1A024**	31-3A024**	31-6A024**	-	31-6A024**	-	61-9A024**	-	-
7 = Receptacle Metal Casing with Lid	-	-	-	39-6A024**	-	39-6A024**	-	39-9A024**	39-2A024**
Ground Ring (Not Shown)	-	-	-	39-6A523	-	39-6A523	-	39-9A523	39-2A523
8 = Lid Replacement Kit Polyester	31-1A125	31-3A125	31-6A125	-	31-6A125	-	31-9A125	-	-
8 = Lid Replacement Kit Metal	-	-	-	39-6A925	-	39-6A925	-	39-9A925	39-2A925
9 = Pawl Replacement Kit Polyester	31-1A824	31-3A824	31-6A824	-	31-6A824	-	31-9A824	-	-
9 = Pawl Replacement Kit Metal	-	-	-	39-6A824	-	39-6A824	-	39-9A824	39-2A824

* Voltage and phasing positions must be specified (5th, 6th & 7th digit of Part #) to duplicate your shutter and alignment notches.

** For appropriate labeling on a device, please specify voltage, phasing, and product type.

***For interiors with pilot contacts, contact Customer Service for part numbers.

For replacement parts contact customer service at 800.433.7642



Dimensions

Inlet – Provided in inches

Dimensions are for reference only and may change depending on accessories used. For precise dimensions contact Meltric Engineering.

Plug

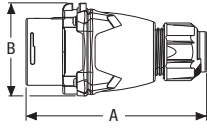

PRODUCT	A	B
DS20/DS24	5.72	2.79
DS30/DS37	6.15	3.23
DS60/DS100C/DS7	6.70	3.77
DS100	8.09	4.79
DS200	10.30	5.67

Inlet with connector

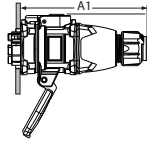

PRODUCT	A1
DS20/DS24	6.67
DS30/DS37	7.05
DS60/DS100C/DS7	8.05
DS100	10.29
DS200	12.44

Inlet

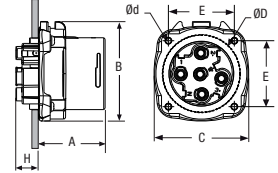

PRODUCT	A	B	C	E	H	Ød	ØD
DS20/DS24	1.86	2.76	2.57	1.89	0.72	0.20	2.07
DS30/DS37	2.07	3.23	3.07	2.17	0.86	0.20	2.48
DS60/DS100C/DS7	2.38	3.77	3.60	2.60	1.04	0.24	3.15
DS100	2.96	4.79	4.50	3.19	1.09	0.24	3.81
DS200	3.20	5.67	5.79	3.86	1.46	0.26	4.57

30° inclined inlet/angle with connector

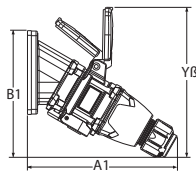

PRODUCT	A1	B1	YB
DS20/DS24	7.50	6.59	7.60
DS30/DS37	8.05	6.89	8.44
DS60/DS100C/DS7	7.90	5.35	9.09
DS100	12.34	10.00	11.34
DS200 60°	11.08	16.81	

30° inlet/angle

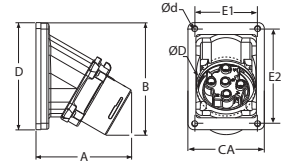

PRODUCT	A	B	CA	D	E1	E2	Ød	ØD
DS20/DS24	3.54	4.56	3.00	4.21	2.48	3.74	0.22	2.25
DS30/DS37	3.93	4.80	3.00	4.21	2.48	3.74	0.22	2.36
DS60/DS100C/DS7	4.42	5.84	4.02	5.35	3.43	4.80	0.26	2.76
DS100	6.11	6.50	5.57	5.57	4.83	4.83	0.28	4.72
DS200 60°	6.90	9.10	7.20	7.20	6.50	6.50	0.25	4.80

30° inclined inlet/angle/ junction box with connector

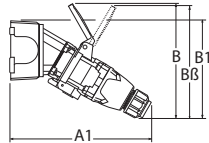

PRODUCT	A1	B	B1	BØ
DS20/DS24	9.23	7.56	6.74	6.85
DS30/DS37	10.30	7.51	7.02	8.46
DS60/DS100C/DS7	11.87	9.09	8.19	10.00
DS100	16.06	12.24	10.00	
DS200 60°	15.76	16.81	13.66	

inlet/angle/ metal junction box

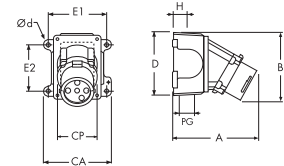

PRODUCT	A	B	CA	CP	D	E1	E2	H	PG	Ød
DS20/DS24	5.89	4.69	4.40	2.48	4.50	3.75	2.75	1.10	1.00	0.27
DS30/DS37	6.26	4.91	4.40	2.48	4.50	3.75	2.75	1.10	1.00	0.27
DS60/DS100C/DS7	7.50	6.00	5.75	3.44	5.84	5.00	3.82	1.50	1.50	0.33
DS100	9.81	6.50	7.50	4.83	5.50	6.75	4.24	1.84	2.00	0.31
DS200 60°	11.60	8.96	9.26	6.50	7.25	8.13	6.38	1.92	2.50	0.31

70° inclined inlet/wall box with connector

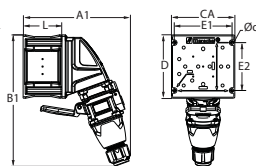

PRODUCT	A1	B1	CA	D	E1	E2	L	Ød
DS20/DS24	8.42	10.50	5.04	5.04	4.57	3.78	3.07	0.26
DS30/DS37	9.53	12.32	6.69	6.69	6.14	5.43	3.07	0.26
DS60/DS100C/DS7	9.84	13.31	6.69	6.69	6.14	5.43	3.07	0.26

70° inlet/wall box

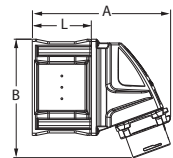

PRODUCT	A	B	L
DS20/DS24	7.17	6.14	3.07
DS30/DS37	8.19	7.70	3.07
DS60/DS100C/DS7	8.31	8.31	3.07

Dimensions

Receptacle – Provided in inches

Dimensions are for reference only and may change depending on accessories used. For precise dimensions contact Meltric Engineering.



connector

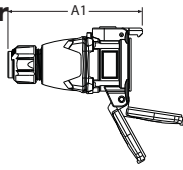

PRODUCT	A1
DS20/DS24	6.38
DS30/DS37	6.93
DS60/DS100C/DS7	7.75
DS100	9.75
DS200	10.87

receptacle with plug

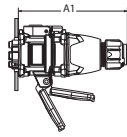

PRODUCT	A1
DS20/DS24	6.67
DS30/DS37	7.05
DS60/DS100C/DS7	8.05
DS100	10.29
DS200	12.06

receptacle

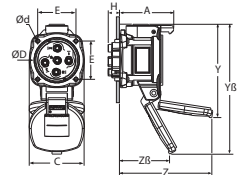

PRODUCT	A	C	E	H	Y	YB	Z	ZB	Ød	ØD
DS20/DS24	2.60	2.61	1.89	0.70	4.14	6.32	4.63	1.93	0.20	2.25
DS30/DS37	2.87	3.04	2.17	0.86	4.48	7.16	4.84	2.33	0.20	2.68
DS60/DS100C/DS7	3.37	3.59	2.60	1.16	6.57	8.46	5.91	2.76	0.22	3.21
DS100	4.60	4.46	3.19	1.09	8.03	10.94	8.70	3.46	0.24	3.81
DS200	4.75	5.16	3.86	1.46	7.99	11.54	8.62	2.48	0.26	4.57

30° inclined receptacle/angle with plug

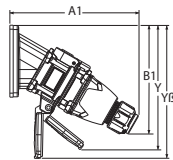

PRODUCT	A1	B1	Y	YB
DS20/DS24	7.50	6.59	6.86	7.87
DS30/DS37	8.05	6.89	8.87	8.44
DS60/DS100C/DS7	7.90	8.07	10.00	10.16
DS100	12.34	10.00	12.05	12.05
DS200 60°	11.08	16.67	15.03	

30° receptacle/angle

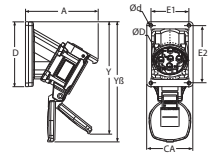

PRODUCT	A	D	E1	E2	Y	YB	Ød	ØD
DS20/DS24	4.51	4.25	2.48	3.74	6.84	7.87	0.22	2.25
DS30/DS37	4.91	4.25	2.48	3.74	8.79	8.43	0.22	2.25
DS60/DS100C/DS7	5.62	5.35	3.43	4.80	9.11	10.32	0.26	2.76
DS100	7.89	5.57	4.83	4.83	12.05	12.05	0.28	4.72
DS200 60°	8.43	7.20	6.50	6.50	15.08		0.25	4.80

30° inclined receptacle/angle/ junction box with plug

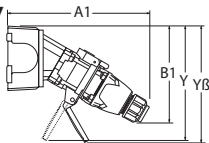

PRODUCT	A1	B1	Y	YB
DS20/DS24	9.84	6.73	7.29	7.94
DS30/DS37	10.30	7.02	8.39	8.39
DS60/DS100C/DS7	11.87	8.19	10.45	9.24
DS100	16.06	9.53	11.77	
DS200 60°	15.76	13.66	11.54	

receptacle/angle/ metal junction box

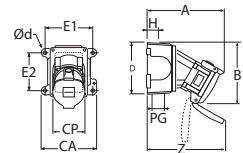

PRODUCT	A	B	CA	CP	D	E1	E2	H	PG	Z	Ød
DS20/DS24	6.86	5.37	4.40	2.61	4.50	3.75	2.75	1.10	1.00	6.77	0.27
DS30/DS37	7.25	5.62	4.40	2.70	4.50	3.75	2.75	1.10	1.00	6.77	0.27
DS60/DS100C/DS7	8.75	7.00	5.75	3.44	5.84	5.00	3.82	1.50	1.50	7.56	0.33
DS100	11.50	7.80	7.50	4.83	5.50	6.75	4.24	1.84	2.00	10.28	0.33
DS200 60°	13.11	9.77	9.25	6.50	7.25	8.13	6.38	1.92	2.50	11.89	0.33

70° inclined receptacle/wall box with plug

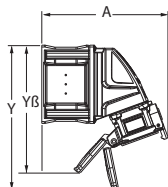

PRODUCT	A	Y	YB
DS20/DS24	8.03	9.25	9.24
DS30/DS37	9.06	9.57	11.30
DS60/DS100C/DS7	9.33	12.56	10.59

70° receptacle/wall box

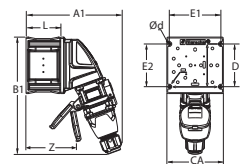

PRODUCT	A1	B1	CA	D	E1	E2	L	Z	Ød
DS20/DS24	8.41	10.50	5.00	5.00	4.57	3.78	3.07	4.91	0.26
DS30/DS37	9.53	12.32	6.69	6.69	6.14	5.43	3.07	4.91	0.26
DS60/DS100C/DS7	9.76	13.03	6.69	6.69	6.22	5.47	3.07	4.09	0.26

DB



Features and Ratings	p. 54
DB30	p. 57
DB60	p. 59
DB100	p. 61
Spare parts	p. 63
Dimensions	p. 65



Switch rated plugs and receptacles

DB's are the most rugged and highest horsepower rated plugs and receptacles in the Decontactor™ Series product family. They are specifically designed for use on motors and other inductive loads. With their unique internal spring operating mechanism, two stage contact system, arc splitting feature and silver-nickel butt contacts, DB's can easily handle high horsepower inductive loads up to 60 hp.

Main Advantages

- ▶ Switch & Hp rated
- ▶ 100 kA short circuit rated*
- ▶ IP67 environmental ratings
- ▶ Up to 4 auxiliary contacts
- ▶ Durable metal construction.

Highlighted Advantage

Simplify Compliance to
NFPA 70E & CSA Z462

See pgs 19-20 for
more information



* See note under General Ratings on the next page

Product Features



Operating Instructions



When the plug and receptacle are latched together, the circuit is connected.



Turning the receptacle ring counterclockwise releases the plug and rapidly opens the circuit. The plug is ejected to its rest position.



From the rest position the 'dead' plug can be withdrawn by rotating it counterclockwise. The receptacle can be made watertight up to IP67 by replacing the lid and turning the locking ring fully clockwise.



To reconnect, insert plug and twist. Pushing the plug fully home safely makes the circuit. The plug is held in the 'on' position by a locking ring. IP67 protection is enabled by fully rotating the locking ring in the clockwise direction.

General Ratings

Amperage	30 to 100A
Voltage	600 VAC
Frequency	50-400 Hz
Horsepower	1 1/2 to 60 hp
Short-Circuit (Make & Withstand)	100kA*
Environmental	IP67
Temperature	min -40°F/max 140°F

* Testing was performed with RK1 current limiting fuses sized at 400% of the highest full load motor ampacity associated with the devices horsepower ratings, except for the DB100, which was tested with 250A fuses.

Highlighted Feature

Typical Device Labels

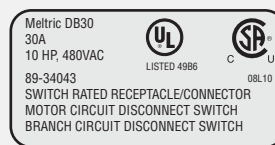

DB Decontactors are UL & CSA rated for "motor circuit" and "branch circuit" disconnect switching – up to 60 hp and up to 100A.

Listings

Category	UL	CSA	IEC
Plugs and Receptacles	UL 1682	C22.2 No. 182.1	60309-1
Branch Circuit Disconnect Switching	UL Subject 2682 (Performance tested to UL 98)	C22.2 No. 4	60947-3, AC22, AC23
Motor Circuit Disconnect Switching	UL Subject 2682 (Performance tested to UL 508)	C22.2 No. 14	

CE ratings available upon request

Product Features

Spring Loaded Operating Mechanism

DB Series Decontactors use an internal spring-loaded operating mechanism to open and close the contacts at high speed, independent of the manual motion of the user.

Load-Making

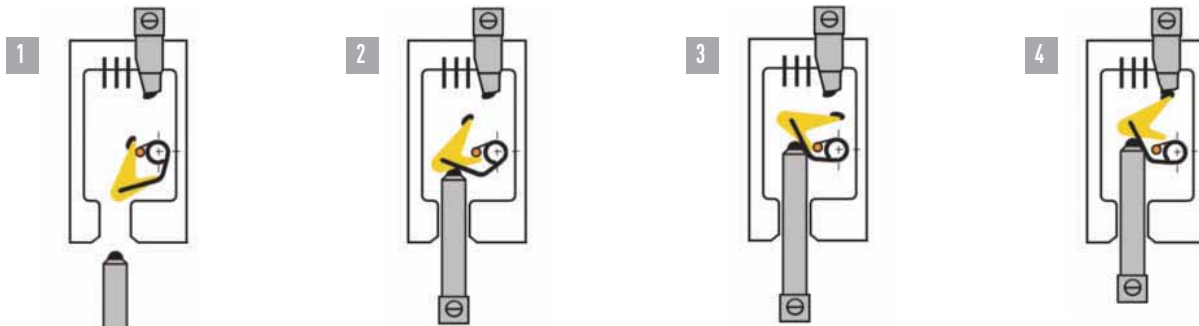

1. As the plug is first inserted into the receptacle, the contact travels toward the operating mechanism. Only the receptacle contact (shown at the top of the drawing) is live.
2. As the plug contact is inserted further, it engages a mobile intermediate contact on the operating mechanism, which it begins to move around a stop. This motion also begins to wind the operating spring.
3. As the plug is inserted further, to the almost completely engaged position, the operating spring becomes fully loaded and the mobile contact rotates into a position where any further insertion motion will release it from the stop.
4. As the last small insertion motion is made, the mobile contact clears the stop and releases the energy in the spring. This instantly drives the mobile contact into engagement with the receptacle contact and completes the electrical connection.

Load-Breaking

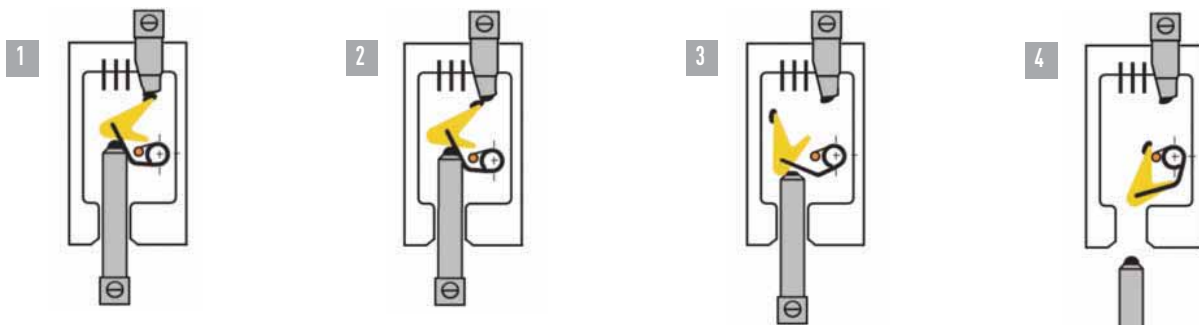

1. When the contacts are engaged, the operating spring is still almost fully charged. This maintains contact pressure and provides energy for the breaking operation.
2. In order to break the circuit, the plug retaining ring is turned to the 'off' position. This releases the plug, which in turn releases the mobile contact and the spring energy in the operating mechanism.
3. The spring energy instantly drives the mobile contact away from the live receptacle contact. It follows a different path than on making and is moved along an arc chute.
4. The mobile contact returns to its initial position, preparing the device to be used again.

Two Stage Contact System

The operation of the DB's contacts was specifically designed to ensure that load-breaking and load-carrying are performed in separate locations on the contacts.

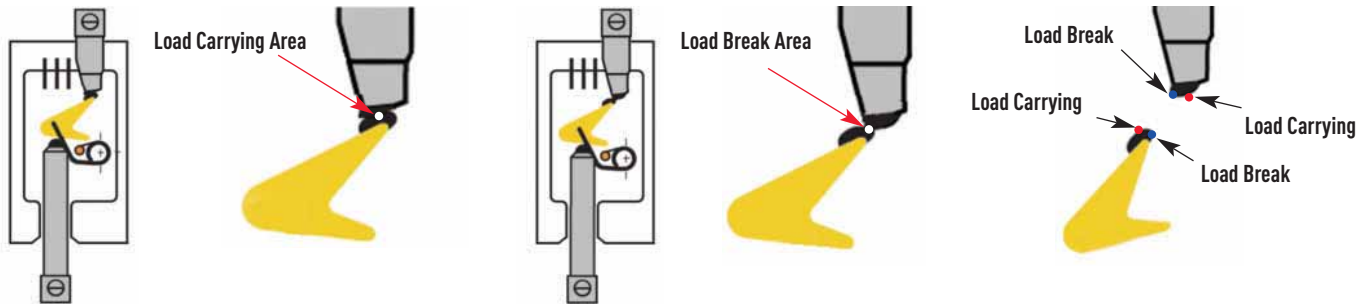

This is accomplished with the motion of the mobile contact relative to the receptacle contact. The opening of the contacts begins with a wiping action that moves the contact area toward the edges of the contacts, where load-breaking occurs. This allows numerous overload-breaking operations without deteriorating the main contact surfaces or the continuity of the connection.

Arc-Extinguishing System

For higher currents, or when significant overloads are involved, additional provision is desirable to handle the arcing that occurs during load-breaking. Meltric accomplishes this on its DB Series Decontactors with a series of magnetic V-shaped blades, which create an arc chute.

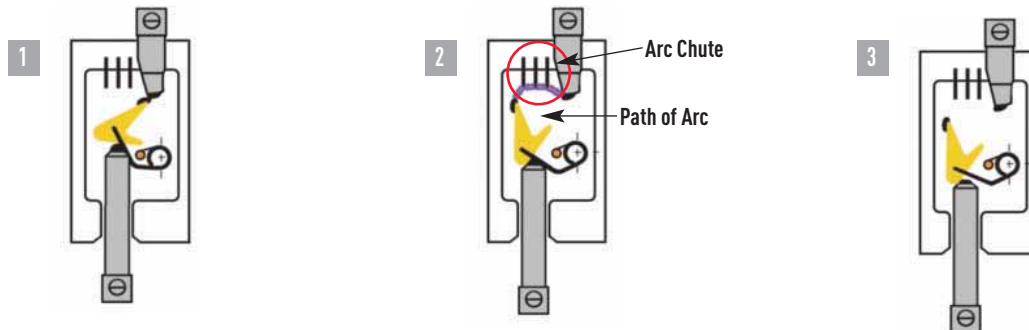

As the contacts open, the mobile intermediate contact moves along the arc chute. The arc is transferred to the magnetic "V" shaped blades, which splits and destabilizes it. This helps to cool and quickly extinguish the arc, minimizing any potential damage to the contacts. Together with the spring operator, two stage contact system and silver-nickel butt style contacts, this feature allows the DB series to easily and safely break high horsepower inductive loads and significant overloads.

DB30



DECONTACTOR™ – 30A

Switch Rated Plugs & Receptacles

Receptacle (female)

Inlet (male)

Ratings

- Voltage**
600 VAC
 - Switch Rating (AC Only)**
Branch Circuit & Motor Circuit Disconnect Switching
 - Horsepower Ratings**
 - 120V 1Ø 1 1/2 hp
 - 240V 1Ø 3 hp
 - 208V 3Ø 7 1/2 hp
 - 240V 3Ø 7 1/2 hp
 - 480V 3Ø 10 hp
 - 600V 3Ø 10 hp
 - Short Circuit Rating**
100kA Close & Withstand
Testing was performed with RK1 current limiting fuses sized at 400% of the highest full load motor ampacity associated with the devices hp rating.
 - Environmental Ratings**
IP67
 - Temperature Range**
Min -40°F/Max 140°F
See pg 220 for temps below -15°F.
 - Wiring Capacity**
Min 14 AWG Max 8 AWG
Aux Contacts - Max 14 AWG
 - Listings**
UL, CSA, IEC, CE*
- * Contact Customer Service



Don't forget to add installation accessories to your order



Voltage	Polarity	Part # Metal
120/208V	3P+N+G	89-34167
125V	1P+N+G	89-34075
125/250V	2P+N+G	89-34076
208V	2P+G	89-34162
208V	3P+G	89-34163
250V	2P+G	89-34072
250V	3P+G	89-34073
277V	1P+N+G	89-34045
277/480V	3P+N+G	89-34047
347/600V	3P+N+G	89-34147
480V	2P+G	89-34042
480V	3P+G	89-34043
600V	2P+G	89-34142
600V	3P+G	89-34143

Voltage	Polarity	Part # Metal
120/208V	3P+N+G	89-38167
125V	1P+N+G	89-38075
125/250V	2P+N+G	89-38076
208V	2P+G	89-38162
208V	3P+G	89-38163
250V	2P+G	89-38072
250V	3P+G	89-38073
277V	1P+N+G	89-38045
277/480V	3P+N+G	89-38047
347/600V	3P+N+G	89-38147
480V	2P+G	89-38042
480V	3P+G	89-38043
600V	2P+G	89-38142
600V	3P+G	89-38143

Other voltage configurations are available – contact customer service at 800.433.7642.

Main Options



Auxiliary/Pilot Contacts

Receptacle Options	Suffix #
With 2 Auxiliary/Pilot Contacts	Recept # - 172*

Inlet Options	Suffix #
With 2 Auxiliary/Pilot Contacts	Inlet # - 172*

* Auxiliary/Pilot Contacts are not available on DB devices with 1P+N+G, 2P+N+G or 3P+N+G polarity

DB30 Order Example:

To order 2 auxiliary/pilot contacts on an inlet and receptacle add -172 to the part numbers.

DB30 Metal inlet 3P+G=89-38043-172

DB30 Metal receptacle 3P+G=89-34043-172

Appropriate accessory part numbers must also be included on the order.

How to Order

Receptacle and Inlet (see above)



Accessories

Angle, Handle, etc are interchangeable (see opposite page)

See pgs 197-206 for detailed information on these options

Installation Accessories

Handles



NPT	Poly Handle	Metal Handle
1/2"	3PH12	3H12
3/4"	3PH34	3H34
1"	3PH1	3H1
1 1/4"	3PH114	3H114
1 1/2"	-	3H112

Cable Range	Poly Handle w/Clamp & Bushing	Nylon Handle
.39 - 1.18	-	FH311
.750 - .875	3PM514	-
.875 - 1.000	3PM516	-
1.000 - 1.125	3PM518	-
1.125 - 1.250	3PM520	-
1.250 - 1.375	3PM522	-

Notes: • For available cord grips, see pgs 193-194.

Angles



Metal 30° Angle	Metal 70° Angle	Metal Angle FS/FD Box 30°	Metal Straight Adapter
MA3	89-3A027	MAFS3	MS3

NPT Guidelines

Cable Range	NPT
.312 - .625	1/2"
.438 - .812	3/4"
.660 - 1.000	1"
.875 - 1.375	1 1/4"

NPT sizes are determined by the cable diameter and third party cord grip.

Junction Boxes



27.7 in³

NPT	Metal Box	Metal Box with Metal Angle
1/2"	MB312	89-3A053-080-12
3/4"	MB334	89-3A053-080-34
1"	MB31	89-3A053-080-1
1 1/4"	MB3114	89-3A053-080-114

+ Interior volume with receptacle installed.

Miscellaneous Accessories



For Male Devices Only



Protective Cap	Cord Grip with Mesh
89-3A126	see pgs 193-194

Order Example

A typical order should include an inlet part number, a receptacle part number **AND** the matching handles, angles or other required accessories.



Male Inlet with Handle (Plug)
89-38075 + FH311



Female Receptacle with Angle Adapter
89-34075 + 89-3A027

DB60



DECONTACTOR™ – 60A

Switch Rated Plugs & Receptacles

Receptacle (female)

Inlet (male)

Ratings

- Voltage**
600 VAC
 - Switch Rating (AC Only)**
Branch Circuit & Motor Circuit Disconnect Switching
 - Horsepower Ratings**
 - 120V 1Ø 3 hp
 - 240V 1Ø 7 1/2 hp
 - 208V 3Ø 15 hp
 - 240V 3Ø 15 hp
 - 480V 3Ø 30 hp
 - 600V 3Ø 30 hp
 - Short Circuit Rating**
100kA Close & Withstand
Testing was performed with RK1 current limiting fuses sized at 400% of the highest full load motor ampacity associated with the devices hp rating.
 - Environmental Ratings**
IP67
 - Temperature Range**
Min -40°F/Max 140°F
See pg 220 for temps below -15°F.
 - Wiring Capacity**
Min 8 AWG Max 3 AWG
Aux Contacts - Max 14 AWG
 - Listings**
UL, CSA, IEC, CE*
- * Contact Customer Service



Voltage	Polarity	Part # Metal
120/208V	3P+N+G	89-64167
125V	1P+N+G	89-64075
125/250V	2P+N+G	89-64076
208V	2P+G	89-64162
208V	3P+G	89-64163
250V	2P+G	89-64072
250V	3P+G	89-64073
277V	1P+N+G	89-64045
277/480V	3P+N+G	89-64047
347/600V	3P+N+G	89-64147
480V	2P+G	89-64042
480V	3P+G	89-64043
600V	2P+G	89-64142
600V	3P+G	89-64143

Voltage	Polarity	Part # Metal
120/208V	3P+N+G	89-68167
125V	1P+N+G	89-68075
125/250V	2P+N+G	89-68076
208V	2P+G	89-68162
208V	3P+G	89-68163
250V	2P+G	89-68072
250V	3P+G	89-68073
277V	1P+N+G	89-68045
277/480V	3P+N+G	89-68047
347/600V	3P+N+G	89-68147
480V	2P+G	89-68042
480V	3P+G	89-68043
600V	2P+G	89-68142
600V	3P+G	89-68143

Other voltage configurations are available – contact customer service at 800.433.7642.

Main Options



Auxiliary/Pilot Contacts

Receptacle Options	Suffix #
With 2 Auxiliary/Pilot Contacts	Recept # - 172*

Inlet Options	Suffix #
With 2 Auxiliary/Pilot Contacts	Inlet # - 172*

* Auxiliary/Pilot Contacts are not available on DB devices with 1P+N+G, 2P+N+G or 3P+N+G polarity

DB60 Order Example:
To order 2 auxiliary/pilot contacts on an inlet and receptacle add -172 to the part numbers.
DB60 Metal inlet 3P+G=89-68043-172
DB60 Metal receptacle 3P+G=89-64043-172
Appropriate accessory part numbers must also be included on the order.

How to Order

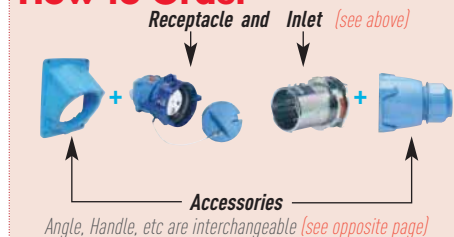

See pgs 197-206 for detailed information on these options

Installation Accessories

Handles



NPT	Poly Handle	Metal Handle	Cable Range	Poly Handle w/Clamp & Bushing	Nylon Handle
1/2"	6PH12	6H12	.51 - 1.38	-	FH611
3/4"	6PH34	6H34	1.250 - 1.375	6PM622	-
1"	6PH1	6H1	1.438 - 1.562	6PM625	-
1 1/4"	6PH114	6H114	1.562 - 1.688	6PM627	-
1 1/2"	6PH112	6H112	1.688 - 1.812	6PM629	-

Notes: • For available cord grips, see pgs 193-194.

Angles

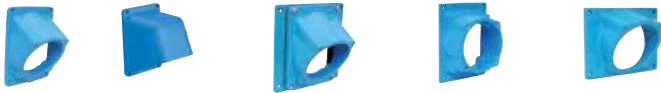

Metal 30° Angle	Metal 70° Angle	Metal Angle ⁺ Oversized 30°	Metal Straight Adapter	Metal Lateral Angle 30°
MA6	89-6A027	MA660	MS6	MAB6

* Mounts on oversize box only. Order with MB10 box. See page 62.

NPT Guidelines

Cable Range	NPT
.312 - .625	1/2"
.438 - .812	3/4"
.660 - 1.000	1"
.875 - 1.375	1 1/4"
.890 - 1.812	1 1/2"

NPT sizes are determined by the cable diameter and third party cord grip.

Junction Boxes



NPT	Metal Box	Metal Box with Metal Angle
1"	MB61	89-6A053-080-1
1 1/4"	MB6114	89-6A053-080-114
1 1/2"	MB6112	89-6A053-080-112
2"	MB62	89-6A053-080-2

* Interior volume with receptacle installed.

Miscellaneous Accessories



For Male Devices Only

Protective Cap

89-6A126



Cord Grip with Mesh

see pgs 193-194

Order Example

A typical order should include an inlet part number, a receptacle part number **AND** the matching handles, angles or other required accessories.



Male Inlet with Handle (Plug)
89-68043 + FH611



Female Receptacle with Angle Adapter
89-64043 + 89-6A027

DB100



DECONTACTOR™ – 100A

Switch Rated Plugs & Receptacles

Ratings

- Voltage**
600 VAC
- Switch Rating (AC Only)**
Branch Circuit & Motor Circuit Disconnect Switching
- Horsepower Ratings**
 - 120V 1Ø 7 1/2 hp
 - 240V 1Ø 10 hp
 - 208V 3Ø 30 hp
 - 240V 3Ø 30 hp
 - 480V 3Ø 60 hp
 - 600V 3Ø 60 hp
- Short Circuit Rating**
100kA Close & Withstand
Testing was performed with 250A RK1 fuses, so the 100kA rating applies up to 60 hp @ 600, 40 hp @ 480V and 20 hp @ 240V and 208V.
- Environmental Ratings**
IP67
- Temperature Range**
Min -40°F/Max 140°F
See pg 220 for temps below -15°F.
- Wiring Capacity**
Min 1/0+ AWG Max 2/0 AWG
Aux Contacts - Max 14 AWG
+ Smaller conductors can be retained in the terminal, but may result in a temperature rise greater than the 30° max allowed in UL & CSA standards.
- Listings**
UL, CSA, IEC, CE*
* Contact Customer Service

Receptacle (female)



Don't forget to add installation accessories to your order

Inlet (male)



Voltage	Polarity	Part # Metal
120/208V	3P+N+G	89-94167
125V	1P+N+G	89-94075
125/250V	2P+N+G	89-94076
208V	2P+G	89-94162
208V	3P+G	89-94163
250V	2P+G	89-94072
250V	3P+G	89-94073
277V	1P+N+G	89-94045
277/480V	3P+N+G	89-94047
347/600V	3P+N+G	89-94147
480V	2P+G	89-94042
480V	3P+G	89-94043
600V	2P+G	89-94142
600V	3P+G	89-94143

Voltage	Polarity	Part # Metal
120/208V	3P+N+G	89-98167
125V	1P+N+G	89-98075
125/250V	2P+N+G	89-98076
208V	2P+G	89-98162
208V	3P+G	89-98163
250V	2P+G	89-98072
250V	3P+G	89-98073
277V	1P+N+G	89-98045
277/480V	3P+N+G	89-98047
347/600V	3P+N+G	89-98147
480V	2P+G	89-98042
480V	3P+G	89-98043
600V	2P+G	89-98142
600V	3P+G	89-98143

Other voltage configurations are available – contact customer service at 800.433.7642.

Main Options



Auxiliary/Pilot Contacts

Receptacle Options	Suffix #
With 4 Auxiliary/Pilot Contacts	Recept # - 174**

Inlet Options	Suffix #
With 4 Auxiliary/Pilot Contacts	Inlet # - 174**

* DB100 devices with auxiliary/pilot contacts are not UL/CSA listed

** Auxiliary/Pilot Contacts are not available on DB devices with 1P+N+G, 2P+N+G or 3P+N+G polarity

DB100 Order Example:
To order 4 auxiliary/pilot contacts on an inlet and receptacle add -174 to the part numbers.
DB100 Metal inlet 3P+G=89-98043-174
DB100 Metal receptacle 3P+G=89-94043-174
Appropriate accessory part numbers must also be included on the order.

How to Order

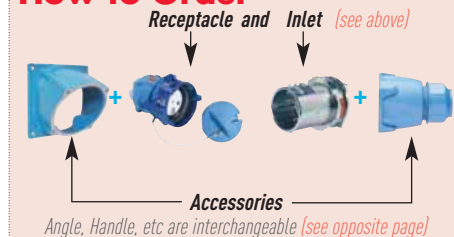

See pgs 197-206 for detailed information on these options

Installation Accessories

Handles



IP 66/67

NPT	Poly Handle	Metal Handle
3/4"	9PH34	9H34
1"	9PH1	9H1
1 1/4"	9PH114	9H114
1 1/2"	9PH112	9H112
2"	9PH2	9H2

Cable Range	Santoprene™ Handle	Poly Handle w/Clamp & Bushing
.70 - 1.00	65-9A013-D25	-
1.00 - 1.375	65-9A013-D35	-
1.250 - 1.375	-	9PM622
1.375 - 1.750	65-9A013-D45	-
1.438 - 1.562	-	9PM625
1.562 - 1.688	-	9PM627
1.688 - 1.812	-	9PM629

Notes: • For available cord grips, see pgs 193-194.

Angles



Metal 30° Angle	Metal 70° Angle	Metal Angle+ Oversized 30°	Metal Straight Adapter
MA10	89-9A027	MA110	MS10

* Mounts on oversize box only. Order with MB220 box. See page 48.

NPT Guidelines

Cable Range	NPT
.438 - .812	3/4"
.660 - 1.000	1"
.875 - 1.375	1 1/4"
.890 - 1.812	1 1/2"
1.190 - 2.438	2"

NPT sizes are determined by the cable diameter and third party cord grip.

Junction Boxes



175.0 in³*

NPT	Metal Box	Metal Box with Metal Angle
1 1/4"	MB10114	89-9A053-080-114
1 1/2"	MB10112	89-9A053-080-112
2"	MB102	89-9A053-080-2

* Interior volume with receptacle installed.

Miscellaneous Accessories



For Male Devices Only



Protective Cap	Cord Grip with Mesh
89-9A126	see pgs 193-194

Order Example

A typical order should include an inlet part number, a receptacle part number **AND** the matching handles, angles or other required accessories.



Male Inlet with Handle (Plug)
89-98043 + 9PM622



Female Receptacle with Angle Adapter
89-94043 + 89-9A027



Spare Parts Male Configuration

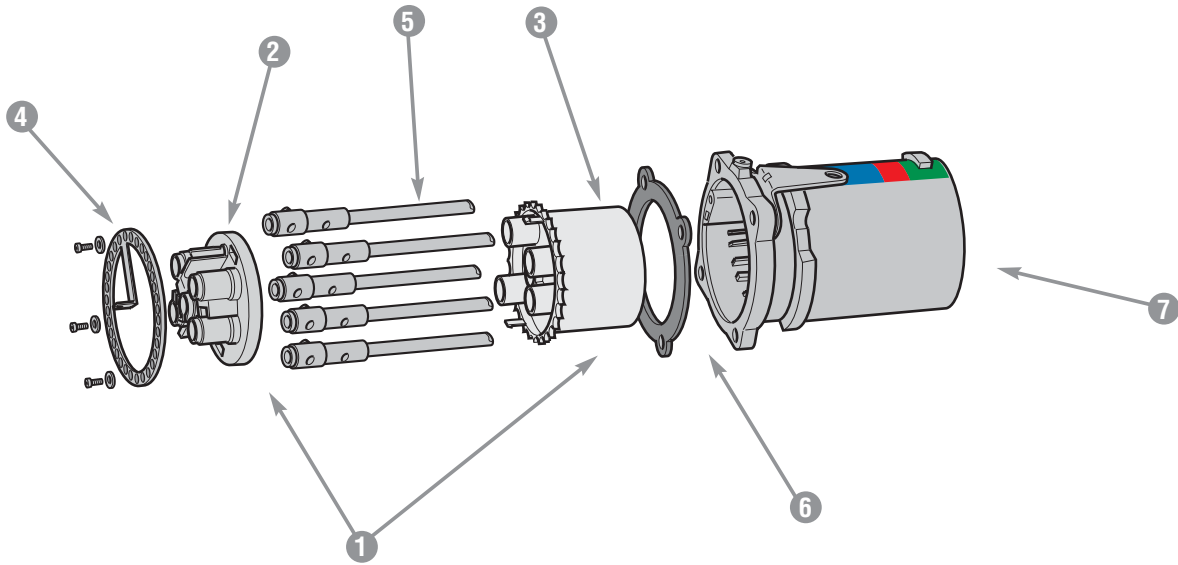

	DB30 METAL	DB60 METAL	DB100 METAL
1 = Plug Interior with Pilot Contact Assembly	89-3A010-172*	89-6A010-172*	89-9A010-174*
1 = Plug Interior without Pilot Contact Assembly	89-3A010*	89-6A010*	89-9A010*
2 = Interior Bottom	89-3A010-B	89-6A010-B	89-9A010-B
3 = Interior Top for Pilot Contact Assembly	89-3A010-T-172*	89-6A010-T-172*	89-9A010-T-174*
3 = Interior Top without Pilot Contact Assembly Holes	89-3A010-T*	89-6A010-T*	89-9A010-T*
4 = Metal Locking Ring/Ground Ring	89-3A523	89-6A523	89-9A523
5 = Ground Contact	89-3A019	89-6A019	89-9A019
5 = Phase or Neutral Contact	89-3A011	89-6A011	89-9A011
5 = Pilot (2 Contacts) Assembly	89-3A219-172	89-6A219-172	-
5 = Pilot (4 Contacts) Assembly	-	-	89-9A219-174
6 = Device Gasket	89-3A026	89-6A026	89-9A026
7 = Plug Metal Casing	89-3A014**	89-6A014**	89-9A014**

* Voltage and phasing positions must be specified (5th, 6th & 7th digit of Part #) to duplicate your shutter and alignment notches.

** For appropriate labeling on a device, please specify voltage, phasing, and product type.

Spare Parts

Female Configuration

DB

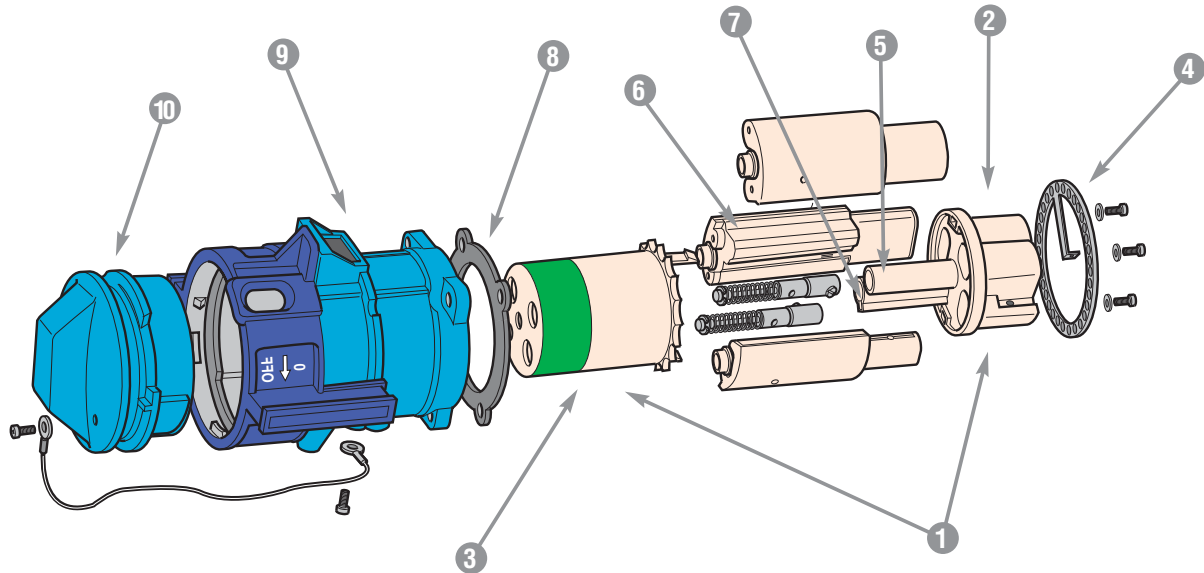

	DB30 METAL	DB60 METAL	DB100 METAL
1 = Receptacle Interior with Pilot Contact Assembly	89-3A020-172*	89-6A020-172*	89-9A020-174*
1 = Receptacle Interior without Pilot Contact Assembly	89-3A020*	89-6A020*	89-9A020*
2 = Interior Bottom	89-3A020-B	89-6A020-B	89-9A020-B
3 = Interior Top for Pilot Contact Assembly	89-3A020-T-172*	89-6A020-T-172*	89-9A020-T-174*
3 = Interior Top without Pilot Contact Assembly Holes	89-3A020-T*	89-6A020-T*	89-9A020-T*
4 = Metal Locking Ring/Ground Ring	89-3A523	89-6A523	89-9A523
5 = Ground Contact	89-3A029	89-6A029	89-9A029
6 = Phase Contact	89-3A021	89-6A021	89-9A021
7 = Neutral Contact	89-3A021N	89-6A021N	89-9A021N
7 = Pilot (2 Contacts) Assembly	89-3A229-172	89-6A229-172	-
7 = Pilot (4 Contacts) Assembly	-	-	89-9A229-174
8 = Device Gasket	89-3A026	89-6A026	89-9A026
9 = Receptacle Metal Casing	89-3A024**	89-6A024**	89-9A024**
10 = Protective Cap with Nylon Cord	89-3A925**	89-6A925**	89-9A925**

* Voltage and phasing positions must be specified (5th, 6th & 7th digit of Part #) to duplicate your shutter and alignment notches.

** For appropriate labeling on a device, please specify voltage, phasing, and product type



Dimensions

Inlet – Provided in inches

Dimensions are for reference only and may change depending on accessories used. For precise dimensions contact Meltric Engineering.

Plug

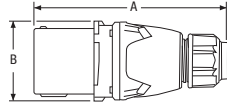

PRODUCT	A	B
DB30	7.86	3.15
DB60	8.26	3.67
DB100	9.78	4.46

Inlet

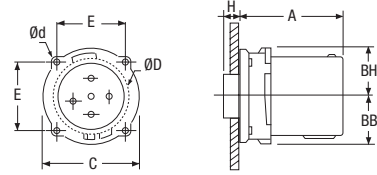

PRODUCT	A	BB	BH	C	E	H	Ød
DB30	3.75	1.50	1.61	3.03	2.17	0.67	0.18
DB60	3.90	1.77	2.13	3.59	2.59	0.73	0.22
DB100	4.63	2.09	2.24	4.57	3.2	1.65	0.22

70° inclined inlet/angle with connector

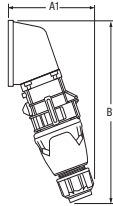

PRODUCT	A1	B1
DB30	6.57	11.54
DB60	7.36	13.46
DB100	9.57	17.80

70° inlet/angle

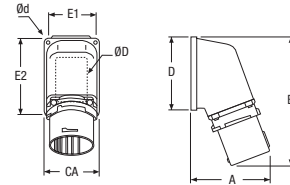

PRODUCT	A	B	CA	D	E1	E2	Ød	ØD
DB30	4.61	7.28	3.03	4.17	2.48	3.74	0.22	2.64
DB60	5.35	8.74	4.02	5.35	3.43	4.80	0.26	3.19
DB100	6.42	9.88	5.51	5.51	4.88	4.88	0.26	4.02

70° inclined inlet/angle/junction box with connector

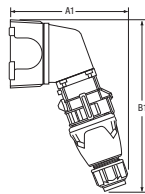

PRODUCT	A1	B1
DB30	8.54	11.65
DB60	9.96	13.66
DB100	12.24	17.60

inlet with connector

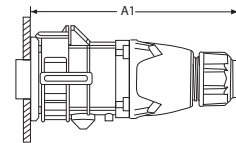

PRODUCT	A1
DB30	8.90
DB60	9.19
DB100	11.50

70° surface inlet/angle/metal junction box

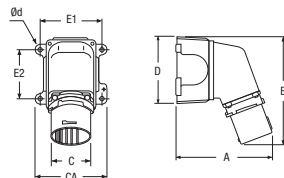

PRODUCT	A	B	CA	D	E1	E2	Ød
DB30	7.09	7.40	4.40	4.50	3.71	2.75	0.25
DB60	8.48	8.94	5.75	5.84	5.00	3.82	0.31
DB100	10.04	9.88	7.50	5.50	6.75	4.24	0.31

Dimensions

Receptacle – Provided in inches

Dimensions are for reference only and may change depending on accessories used. For precise dimensions contact Meltric Engineering.

connector

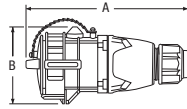

PRODUCT	A	B
DB30	9.26	4.16
DB60	9.83	4.94
DB100	11.91	5.75

receptacle

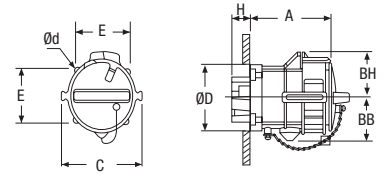

PRODUCT	A	BB	BH	C	E	H	Ød	ØD
DB30	5.16	1.77	1.77	4.36	2.17	1.01	0.18	3.05
DB60	5.46	2.01	2.01	4.86	2.59	1.06	0.22	3.60
DB100	6.77	2.45	2.48	5.75	3.20	1.75	0.22	4.50

70° inclined receptacle/angle with plug

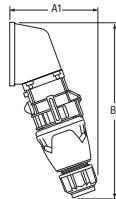

PRODUCT	A1	B1
DB30	6.57	11.54
DB60	7.36	13.46
DB100	9.57	17.80

70° receptacle/angle

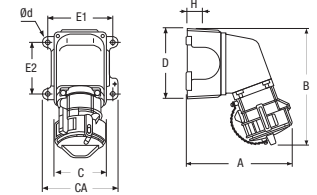

PRODUCT	A	B	CA	D	E1	E2	Ød
DB30	5.24	7.83	3.03	4.17	2.48	3.74	0.22
DB60	6.10	9.72	4.02	5.35	3.43	4.80	0.26
DB100	7.13	10.55	5.51	5.51	4.88	4.88	0.28

70° inclined receptacle/angle/ junction box with plug

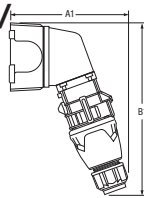

PRODUCT	A1	B1
DB30	8.54	11.65
DB60	9.96	13.66
DB100	12.24	17.60

receptacle with plug

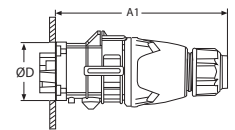

PRODUCT	A1	ØD
DB30	8.90	3.05
DB60	9.19	3.60
DB100	11.50	4.50

70° receptacle/angle/ metal junction box

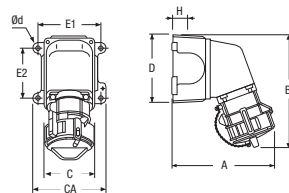

PRODUCT	A	B	CA	CP	D	E1	E2	H	PG	Ød
DB30	7.72	7.95	3.31	4.40	4.50	3.75	2.75	1.10	1.00	0.27
DB60	9.21	9.92	4.49	5.75	5.84	5.00	3.82	1.50	1.50	0.33
DB100	10.75	10.55	5.51	7.50	5.50	6.75	4.24	1.84	2.00	0.31

Hazardous Location Plugs & Receptacles

The Meltric Advantage

Meltric offers a range of hazardous duty rated devices for use in power supply and control applications. Each device features Meltric's silver-nickel butt-style contact technology that maximizes durability and performance. Depending on application needs, each device can be configured for use in in-line and wall mounted applications.

Common industry applications:

- ▶ Chemical plants
- ▶ Pharmaceutical plants
- ▶ Oil and Gas facilities
- ▶ Grain silos
- ▶ Wood processing plants
- ▶ Plastics plants
- ▶ Wastewater plants



"Flush Mounted" DX Series plug and receptacle



"Inline" DXN Series plug and connector

Explanation of Area Classifications and Relevant Listings

Meltric plugs and receptacles are ATEX rated for use in zone 1/21 and zone 2/22 classified areas. Additionally, the DXN Series plugs and receptacles are CSA Class I, Division 2 and Class II, Division 2 rated and CSA Class I Zone 1 and Class II Zone 21 rated (US and Canada). The reference table below shows the North American rating system and the corresponding IEC system.

Gas

Explosive atmosphere	Continuously present	May occur in normal conditions	May appear accidentally or in abnormal conditions
North American	Class I, Division 1		Class I, Division 2
IEC / Europe	Zone 0	Zone 1	Zone 2

Dust

Explosive atmosphere	Continuously present	May occur in normal conditions	May appear accidentally or in abnormal conditions
North American	Class II, Division 1		Class II, Division 2
IEC / Europe	Zone 20	Zone 21	Zone 22

DXN Series devices carry ratings highlighted in yellow AND gray.

DX, DXN25C, DXN37C, PXN12C, SPeX devices carry ratings highlighted in yellow ONLY.

Selecting the Right Hazardous Location Rated Plug & Receptacle

Product Line Summary

DXN plugs and receptacles are ideal for power connections where compact, lightweight devices are preferred. DXN's are ATEX and CSA rated and can be configured for inline or wall mounted applications.

DX plugs and receptacles are excellent for use where rugged metal construction is required and when there is a need for amperages up to 100A. DX's are ATEX rated.

DXN25C and DXN37C multipin plugs and receptacles are excellent for low amperage control applications. Twenty-five and thirty-seven contacts are available on the devices which are ATEX rated up to 10A and 440V (DXN25C) or 10A and 220V (DXN37C).

PXN12C multipin plugs and receptacles are ideal for applications requiring compact size. Twelve contacts are available with ATEX ratings up to 10A and 220V.

SPeX single pole plugs and connectors are suitable for high amperage applications up to 680A and 1000V where safety and ease of operation are preferred. SPeX's are ATEX rated.



Hazardous Duty Product Specifications

Product Type	Housing Material	Voltage (Max)	Number of Contacts	Amperage		Wiring Capacity		Environmental Rating	Wiring Connection	Catalog Page
				Current Interrupting	Non-Current Interrupting	Min	Max			
DXN20	Polyester	480	3P+N+G	20	-	20 AWG	10 AWG	IP66+IP67	Screw	73
DXN30	Polyester	600	3P+N+G	30	-	14 AWG	6 AWG	IP66+IP67	Screw	75
DXN60	Polyester	600	3P+N+G	60	-	10 AWG	4 AWG	IP66+IP67	Screw	77
DX20	Aluminum	600	3P+N+G	20	-	14 AWG	6 AWG	IP65	Screw	85
DX30	Aluminum	600	3P+N+G	30	-	14 AWG	6 AWG	IP65	Screw	86
DX60	Aluminum	600	3P+N+G	60	-	8 AWG	2 AWG	IP65	Screw	87
DX100	Aluminum	600	3P+N+G	100	-	4 AWG	2 AWG	IP65	Screw	88
DXN25C	Metal	440	24P+G	-	10	16 AWG	14 AWG	IP66+IP67	Solder	92
DXN37C	Metal	220	36P+G	-	10	16 AWG	14 AWG	IP66+IP67	Solder	92
PXN12C	Metal	220	11P+G	-	10	16 AWG	14 AWG	IP65+IP66	Solder	94
SPeX	Polyester	1000	1	-	680	2/0 AWG	750 MCM	IP66	LUG	96

DXN



Features and Ratings	p. 70
Certifications and Testing	p. 71
Operation	p. 72
DXN20	p. 73
DXN30	p. 75
DXN60	p. 77
Dimensions	p. 79



Hazardous location rated plugs and receptacles

DXN Series plugs and receptacles are convenient, lightweight devices that are safe for use in hazardous environments such as refineries or silos where exposure to flammable gas or dust is a concern. The DXN's compact size and durable construction makes them easy to handle and well suited for in-line connections of electrical equipment. The DXN's dead front construction assures electrical safety by preventing user access to live parts. IP66+IP67 ratings are achieved as soon as the plug and receptacle are mated, making them the perfect choice for wet or dusty environments.

Main Advantages

- ▶ Easy to handle due to compact, lightweight design
- ▶ Available in in-line and wall/panel mounted configurations
- ▶ CSA and ATEX rated for use in Zones 1 and 2 (gas) and Zones 21 and 22 (dust).

Product Features



Silver-Nickel Contacts

Silver-nickel contact material provides superior conductivity, durability and corrosion resistance.

Hazardous Location Termination Areas

Includes enhanced creepage and clearance distances and specially designed terminals to ensure perfect and permanent clamping.

Casing

Self-extinguishing, non-static, material provides outstanding resistance to mechanical abuse and chemicals.

Pushbutton Pawl/OFF Button

Provides quick, safe and easy current interruption.

Spring-Loaded Butt-Style Contacts

Ensures optimal contact force and superior electrical performance over thousands of operations.

Explosion Proof Arc Chamber

Withstands internal pressure due to gas/dust ignited by arcing and isolates it from the outside environment.

Explosion Proof Flame Path

Dissipates internal pressure created during arcing while also preventing any associated ignition sources from reaching the surrounding atmosphere.

Lid

When closed, the lid maintains IP66+IP67 protection for the receptacle after removal of the plug.

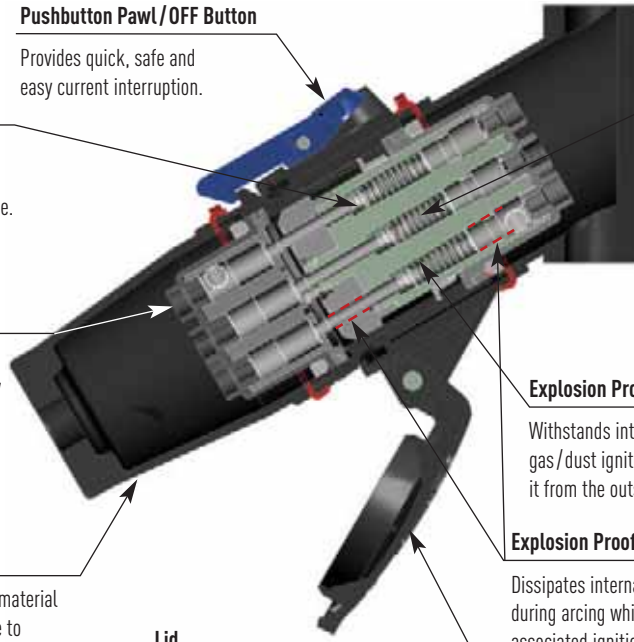

Operating Instructions



To connect, align the red dots, push the plug partially in, then turn clockwise slightly to line up the latch with the catch.



Push the plug fully home until it is held in place by the latch. The circuit is now closed.



To disconnect, depress the latch and pull the plug simultaneously. This breaks the circuit. The plug contacts are now dead.



Rotate 30° counterclockwise and then withdraw the plug. The safety shutter prevents access to live parts.

General Ratings

Amperage	20 to 60A
Voltage	600 VAC*, 250 VDC Max
Frequency	50-400 Hz
Environmental	IP66+IP67
Temperature	min -40°F/max 140°F

* DXN20 devices are 480 VAC
DXN30 and DXN60 devices are 550VAC if ordered with optional auxiliary contacts

Hazardous Duty Listings

CSA	ATEX
Class I, Zone 1 Ex IIC T*, Class II, Zone 21	II 2 G/D Ex ed IIC T* Ex ED A2I T*
Class I, Zone 1 AEx, de IIC T*	
Class I Division 2 Gr A, B, C, D	
Class II Division 2 Gr E, F, G	

* See temperature tables in product sections
See following page for additional ratings detail

Plug & Receptacle Listings

Category	CSA	IEC
Plugs and Receptacles	C22.2 No. 182.1	60309-1

CE ratings available upon request

Highlighted Feature

Dead Front



The dead front on the DXN receptacle provides protection from accidental tool and wire insertion.

DXN Certifications

Hazardous Duty Certification (example)

DXN's have CSA and ATEX certifications for use in hazardous locations.



CSA

Class I, Zone 1, Ex de IIC T6*, **Class II, Zone 21**

Class I, Zone 1, AEx de IIC T6*

Class I Division 2 Gr A,B,C,D

Class I – Indicates suitability for use in applications where flammable Gases, Vapors, or Mists may be present.

Zone I – Indicates suitability for use in applications where an explosive environment is likely to occur.

Division 2 – Indicates suitability for use where exposure to the hazard occurs under abnormal conditions.

GR A,B,C,D – Indicates suitability for use in areas that may contain Acetylene, Hydrogen, Ethylene, or Propane.

Class II Division 2 Gr E,F,G

Class II – Indicates suitability for use in applications where explosive dust atmosphere may occur.

Division 2 – Indicates suitability for use where hazard exposure occurs under abnormal conditions.

GR E,F,G – Indicates suitability for use in areas where Magnesium, Coal or Grain dust may occur.

CSA certification based on IEC 60079-0, 60079-1, 60079-7

ATEX and IECEx

II 2 G/D Ex de IIC T6*

II – Indicates suitability for installation in surface applications (as opposed to underground mine applications).

2 – Indicates suitability for use where a high level of protection is required and where the presence of an explosive atmosphere is likely to occur (Zone 1 and Zone 21 environments).

G/D – Indicates suitability for installation in areas that may contain flammable gases, vapors/mists, or dusts.

T85°C* – Indicates a maximum surface temperature of the product of 85°C, at 40°C ambient.

Ex de – Indicates that explosion protection is provided with (e) increased safety in the conductor termination area, and (d) flame proof chambers for making and breaking the current that can withstand the pressure of internal ignition and that prevent arcs, flame or other ignition events from being communicated to the surrounding atmosphere.

IIC – Indicates suitability for installation in areas where exposure to any type of gas, including the most dangerous subdivision C gases may occur.

T6* – Temperature class – the maximum product surface temperature is 185°F (85°C) for ambient temperature of 104°F (40°).

ATEX certification was performed by LCIE.

** Temperature ratings vary depending on product and ambient temperature. See specific product section for temperature ratings.*

Electrical Performance Testing

Key Performance Tests Passed					
Model	Mechanical Endurance	Electrical Endurance ¹	Overload Testing ²	Temperature Rise (max)	Dielectric Test
DXN20	-	5000 Operations	50 Operations	30°C	2 x V (rated) + 1000V
DXN30	1000 Cycles	1000 Operations	50 Operations	30°C	2 x V (rated) + 1000V
DXN60	1000 Cycles	1000 Operations	50 Operations	30°C	2 x V (rated) + 1000V

¹ @ 100% of rated current and voltage and 0.6 power factor ² @ 125% of rated current, 110% of rated voltage, & 0.6 power factor

DXN Operation

Arcing is a natural occurrence when electrical contacts make and break under load. The purpose of a hazardous duty product is to prevent arcing from igniting hazardous gases or dusts present in the atmosphere into an explosion that may cause personal injury or damage to facilities and equipment. The DXN accomplishes this with specially designed flame-proof arc chambers.

The arc chambers are sized to minimize the amount of atmospheric gas or air/dust mixture that may ignite during arcing and are built to contain this internal mini-explosion and withstand the pressure that it generates. The length and width of the flame-proof pathways are very precisely designed to provide for the effective dissipation of the pressure, while also ensuring that the arcing and internal ignitions of gases or air/dust mixture in the arc chamber are totally isolated from the surrounding atmosphere.

- 1 When the plug and receptacle are connected, the flameproof arc chamber is completed with pressure relief/arc extinguishing pathways between the outer diameter of the plug contact and its associated contact hole in the safety shutter and between the main interior component and receptacle contact base.
- 2 DXN's are current interrupting rated devices. They can safely make and break under full load and also during moderate overload situations. During the making or breaking of the contacts, the arc chamber completely contains any ignitions of gas or dust due to arcing and the flame-proof pathways dissipate the pressure.
- 3 As the plug is being inserted or removed, the flame-proof arc chamber and pathways are maintained. This ensures continuous hazardous duty protection and the safety of the user.
- 4 When the plug and receptacle are disconnected, the receptacle maintains a flame-proof chamber. In this case, the flame-proof pathway exists between the safety shutter and the main interior component. The shutter also prevents access to live parts, providing users with the safety of a dead front. The plug must be inserted into the safety shutter and be rotated in order to access the receptacle contacts.

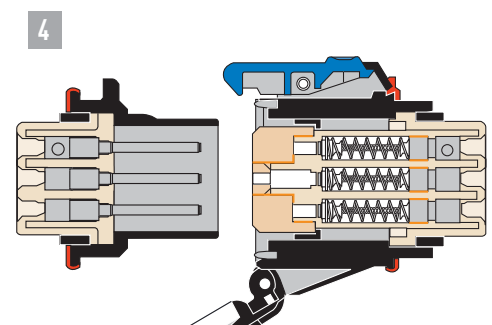
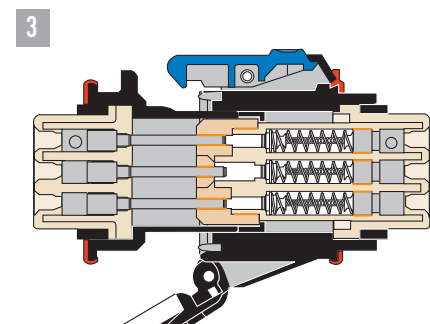
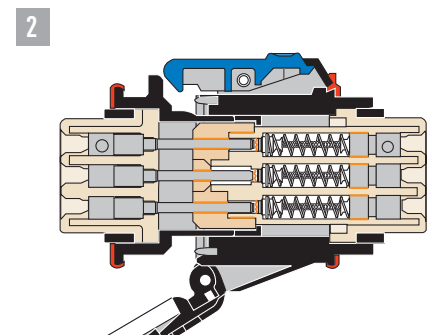
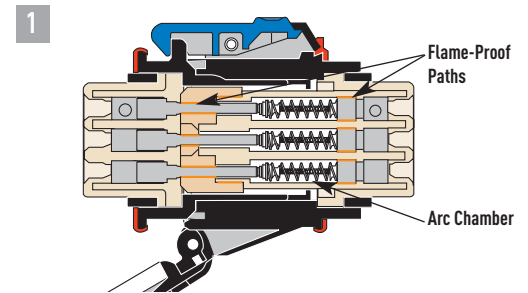

DXN20



DXN – 20A Hazardous Location Plugs & Receptacles

Ratings

- **Voltage**
480 VAC
- **Current Interruption Capability**
For current interrupting (AC)
- **Environmental Ratings**
IP66+IP67
- **Wiring Capacity**
Min 16 AWG Max 10 AWG
* Based on THHN wire sizes
- **Listings**
CSA, IECEx, ATEX
* For CE rated devices, contact customer service
- **DXN20 Ratings Label**

-40°C ≤ Ta ≤ +60°C
Class I Zone1 Ex de IIC T5 DIP A21 T90°C
Class I Zone1 AEx de IIC T5 tD 21 T90°C
Class I div 2 Gr IIC (A,B,C,D)
Class II div 2 Gr E,F,G
cCSAus 208161-1144106X

The CSA ratings are applicable for USA and Canada

Temperature Table

Ambient Temperature	Gas	Dust
-40°F < Ta < 104°F	T6	T70°C
-40°F < Ta < 140°F	T5	T90°C

Receptacle (female)



Don't forget to add installation accessories to your order

Standard DXN20 lid opens to 120°

Inlet (male)



Hazardous Location rating terminology and labeling is different for CE marked products – contact customer service for part numbers if international ratings are desired.

Voltage	Polarity	Part # Poly
125V	1P+N+G	22-14075
208V	2P+G	22-14162
208V	3P+G	22-14163
208V	3P+N+G	22-14167
250V	2P+G	22-14072
250V	3P+G	22-14073
250V	2P+N+G	22-14076
277V	1P+N+G	22-14045
480V	2P+G	22-14042
480V	3P+G	22-14043
480V	3P+N+G	22-14047

Voltage	Polarity	Part # Poly
125V	1P+N+G	22-18075
208V	2P+G	22-18162
208V	3P+G	22-18163
208V	3P+N+G	22-18167
250V	2P+G	22-18072
250V	3P+G	22-18073
250V	2P+N+G	22-18076
277V	1P+N+G	22-18045
480V	2P+G	22-18042
480V	3P+G	22-18043
480V	3P+N+G	22-18047

Other voltage configurations are available – contact customer service at 800.433.7642.

Main Options



Padlock Pawl



Normally Closed Lid Configuration (unlatched)



180° Lid Opening (for connecting to wall mounted inlets)



See pgs 197-206 for detailed information on these options

Receptacle Options	Part #
Padlock Pawl	Recept # - 843
Metal Pawl on Poly Receptacle	Recept # - 924
Closed Lid Configuration	Recept # - R
180° Lid Opening	Recept # - 180

Inlet Options	Part #
No Lockout Hole	Inlet # - A155

How to Order



DXN20 Order Example:

To order a padlock pawl on a receptacle, add **-843** to the part number.

DXN20 Poly receptacle 3P+G=22-14043-**843**

Appropriate accessory part numbers must also be included on the order.

Installation Accessories

Handles



For Zone 1/21 applications



For use with Class I/II Division 2 or Zone 1/21 fittings

Cable Range	Poly Handle w/Bushing*	NPT	Poly Handle w/NPT***
.31 - .51	22-1A013-20P*	1/2"	22-1A013-12***
.51 - .75	22-1A013-25P*	3/4"	22-1A013-34***
.67 - .98	22-1A013-32P*		

+ ATEX rated for use in Zone 1/21, not listed for Class I or II, Division 2.
 *** For use in Class I or II, Division 2 or Zone 1/21 depending on fitting used. Fitting manufactured by others.

NPT Guidelines

Cable Range	NPT
.312 - .625	1/2"
.438 - .812	3/4"

NPT sizes are determined by the cable diameter and third party cord grip.

Angles Wall Boxes



4.5 in³+



4.5 in³+



82.3 in³+

Nylon 30° Angle	NPT	Poly 30° Wall Box+	Poly 30° Wall Box++	Poly 70° Wall Box
22-1A027	1/2"	22-1A023-12-T	22-1A023-12-B	22-1AB58
	3/4"	22-1A023-34-T	22-1A023-34-B	-

+ NPT thread on top
 ++ NPT thread on bottom
 + Interior volume with receptacle installed.

Accessory Spotlight

Finger Drawplates



Finger drawplates are recommended for easier connector closure on cord to cord assemblies.

Miscellaneous Accessories



Set of Two (2)



For Male Devices Only

Finger Drawplates	Protective Cap
61-1A346	61-1A426

Order Example

A typical order should include an inlet part number, a receptacle part number **AND** the matching handles, angles or other required accessories.



Male Inlet with Handle (Plug)
 22-18043 + 22-1A013-20P



Female Receptacle with Wall Box
 22-14043 + 22-1A023-12-T

DXN30



DXN – 30A Hazardous Location Plugs & Receptacles

Ratings

- **Voltage**
600 VAC
 - **Current Interruption Capability**
For current interrupting (AC)
 - **Environmental Ratings**
IP66+IP67
 - **Wiring Capacity**
Min 12 AWG Max 6 AWG
Aux Contacts - Max 10 AWG
- * Based on THHN wire sizes

Listings

CSA, IECEx, ATEX

* For CE rated devices, contact customer service

DXN30 Ratings Label

-40°C ≤ Ta ≤ +60°C
Class I Zone1 Ex de IIC T4 DIP A21 T98°C
Class I Zone1 AEx de IIC T4 tD 21 T98°C
Class I div 2 Gr IIC (A,B,C,D)
Class II div 2 Gr E,F,G
cCSAus 208161-1144106X

The CSA ratings are applicable for USA and Canada

Temperature Table

Ambient Temperature	Gas	Dust
-40°F < Ta < 104°F	T6	T57°C
-40°F < Ta < 140°F	T5	T77°C

Receptacle (female)



Don't forget to add installation accessories to your order

Standard DXN30 lid opens to 120°

Inlet (male)



Hazardous Location rating terminology and labeling is different for CE marked products – contact customer service for part numbers if international ratings are desired.

Voltage	Polarity	Part # Poly
125V	1P+N+G	22-34075
208V	2P+G	22-34162
208V	3P+G	22-34163
208V	3P+N+G	22-34167
250V	2P+G	22-34072
250V	3P+G	22-34073
250V	2P+N+G	22-34076
277V	1P+N+G	22-34045
480V	2P+G	22-34042
480V	3P+G	22-34043
480V	3P+N+G	22-34047
600V	2P+G	22-34142
600V	3P+G	22-34143
600V	3P+N+G	22-34147

Voltage	Polarity	Part # Poly
125V	1P+N+G	22-38075
208V	2P+G	22-38162
208V	3P+G	22-38163
208V	3P+N+G	22-38167
250V	2P+G	22-38072
250V	3P+G	22-38073
250V	2P+N+G	22-38076
277V	1P+N+G	22-38045
480V	2P+G	22-38042
480V	3P+G	22-38043
480V	3P+N+G	22-38047
600V	2P+G	22-38142
600V	3P+G	22-38143
600V	3P+N+G	22-38147

Other voltage configurations are available – contact customer service at 800.433.7642.

Main Options



Padlock Pawl



Normally Closed Lid Configuration (unlatched)



180° Lid Opening (for connecting to wall mounted inlets)



See pgs 197-206 for detailed information on these options

Receptacle Options

Part

With 2 Auxiliary/Pilot Contacts*	Recept # - 972
Padlock Pawl	Recept # - 843
Metal Pawl on Poly Receptacle	Recept # - 924
Closed Lid Configuration	Recept # - R
180° Lid Opening	Recept # - 180

* Not available with 600V devices, use -972-S74 for 550VAC

Inlet Options

Part

With 2 Auxiliary/Pilot Contacts*	Inlet # - 972
No Lockout Hole	Inlet # - A155

How to Order

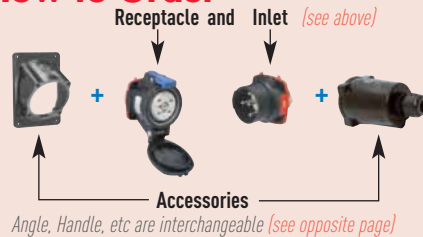

Option Spotlight

2 Auxiliary Contacts



2 auxiliary/pilot contacts can be added for signal or control circuits. Avoid the need for separate connectors.

To order add -972 to the inlet and receptacle part numbers.

Installation Accessories

Handles

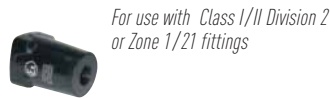

Cable Range	Poly Handle w/Bushing*	NPT	Poly Handle w/NPT***
.31 - .51	22-3A013-20P+	3/4"	22-3A013-34***
.51 - .75	22-3A013-25P+	1"	22-3A013-1***
.67 - .98	22-3A013-32P+		
.95 - 1.26	22-3A013-40P+		

* ATEX rated for use in Zone 1/21, not listed for Class I or II, Division 2.
 *** or use in Class I or II, Division 2 or Zone 1/21 depending on fitting used. Fitting manufactured by others.

NPT Guidelines

Cable Range	NPT
.438 - .812	3/4"

NPT sizes are determined by the cable diameter and third party cord grip.

Angles Wall Boxes



Nylon 30° Angle	NPT	Poly 30° Wall Box+	Poly 30° Wall Box++	Poly 70° Wall Box
22-3A027	3/4"	22-3A023-34-T	22-3A023-34-B	22-3AB58

* NPT thread on top
 ** NPT thread on bottom
 * Interior volume with receptacle installed.

Accessory Spotlight

Finger Drawplates



Finger drawplates are recommended for easier connector closure on cord to cord assemblies.

Miscellaneous Accessories



Set of Two (2)

For Male Devices Only

Finger Drawplates	Protective Cap
61-3A346	22-3A126

Order Example

A typical order should include an inlet part number, a receptacle part number **AND** the matching handles, angles or other required accessories.



Male Inlet with Handle (Plug)
 22-38043 + 22-3A013-25P



Female Receptacle with Wall Box
 22-34043 + 22-3A023-34-T

DXN60



DXN – 60A Hazardous Location Plugs & Receptacles

Ratings

- **Voltage**
600 VAC
 - **Current Interruption Capability**
For current interrupting (AC)
 - **Environmental Ratings**
IP66+IP67
 - **Wiring Capacity**
Min 10 AWG Max 4 AWG
Aux Contacts - Max 10 AWG
- * Based on THHN wire sizes

Listings*

CSA, IECEx, ATEX

* For CE rated devices, contact customer service

DXN60 Ratings Label

-40°C ≤ Ta ≤ +60°C
Class I Zone1 Ex de IIC T5 DIP A21 T100°C
Class I Zone1 AEx de IIC T5 tD 21 T100°C
Class I div 2 Gr IIC (A,B,C,D)
Class II div 2 Gr E,F,G
cCSAus 208161-1144106X

The CSA ratings are applicable for USA and Canada

Temperature Table

Ambient Temperature	Gas	Dust
-40°F < Ta < 104°F	T6	T80°C
-40°F < Ta < 140°F	T54	T100°C

Receptacle (female)



Don't forget to add installation accessories to your order

Standard DXN60 lid opens to 120°

Inlet (male)



Hazardous Location rating terminology and labeling is different for CE marked products – contact customer service for part numbers if international ratings are desired.

Voltage	Polarity	Part # Poly
125V	1P+N+G	22-64075
208V	2P+G	22-64162
208V	3P+G	22-64163
208V	3P+N+G	22-64167
250V	2P+G	22-64072
250V	3P+G	22-64073
250V	2P+N+G	22-64076
277V	1P+N+G	22-64045
480V	2P+G	22-64042
480V	3P+G	22-64043
480V	3P+N+G	22-64047
600V	2P+G	22-64142
600V	3P+G	22-64143
600V	3P+N+G	22-64147

Voltage	Polarity	Part # Poly
125V	1P+N+G	22-68075
208V	2P+G	22-68162
208V	3P+G	22-68163
208V	3P+N+G	22-68167
250V	2P+G	22-68072
250V	3P+G	22-68073
250V	2P+N+G	22-68076
277V	1P+N+G	22-68045
480V	2P+G	22-68042
480V	3P+G	22-68043
480V	3P+N+G	22-68047
600V	2P+G	22-68142
600V	3P+G	22-68143
600V	3P+N+G	22-68147

Other voltage configurations are available – contact customer service at 800.433.7642.

Main Options



Padlock Pawl



Normally Closed Lid Configuration (unlatched)

Receptacle Options	Part #
With 2 Auxiliary/Pilot Contacts*	Recept # - 972
Padlock Pawl	Recept # - 843
Metal Pawl on Poly Receptacle	Recept # - 924
Closed Lid Configuration	Recept # - R
180° Lid Opening	Recept # - 180

Inlet Options	Part #
With 2 Auxiliary/Pilot Contacts*	Inlet # - 972

* Not available with 600V devices, use -972-S74 for 550 VAC.

How to Order



Option Spotlight

2 Auxiliary Contacts

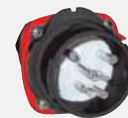

2 auxiliary/pilot contacts can be added for signal or control circuits. Avoid the need for separate connectors.

To order add -972 to the inlet and receptacle part numbers.

Installation Accessories

Handles

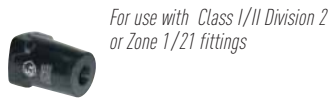

Cable Range	Poly Handle w/Bushing*	NPT	Poly Handle w/NPT***
.51 - .75	22-6A013-25P*	1"	22-6A013-1***
.67 - .98	22-6A013-32P*		
.95 - 1.26	22-6A013-40P*		

+ ATEX rated for use in Zone 1/21, not listed for Class I or II, Division 2.
 *** For use in Class I or II, Division 2 or Zone 1/21 depending on fitting used. Fitting manufactured by others.

NPT Guidelines

Cable Range	NPT
.660 - 1.000	1"

NPT sizes are determined by the cable diameter and third party cord grip.

Angles Wall Boxes



Nylon 30° Angle	NPT	Poly 30° Wall Box+	Poly 30° Wall Box++	Poly 70° Wall Box
22-6A027	1"	22-6A023-1-T	22-6A023-1-B	22-6AB58

+ NPT thread on top
 ++ NPT thread on bottom
 * Interior volume with receptacle installed.

Accessory Spotlight

Finger Drawplates



Finger drawplates are recommended for easier connector closure on cord to cord assemblies.

Miscellaneous Accessories



Set of Two (2)

For Male Devices Only

Finger Drawplates	Protective Cap
61-6A346	22-6A126

Order Example

A typical order should include an inlet part number, a receptacle part number **AND** the matching handles, angles or other required accessories.



Male Inlet with Handle (Plug)
 22-68043 + 22-6A013-32P



Female Receptacle with Wall Box
 22-64043 + 22-6A023-1-T



Dimensions

Inlet – Provided in inches

Dimensions are for reference only and may change depending on accessories used. For precise dimensions contact Meltric Engineering.

plug

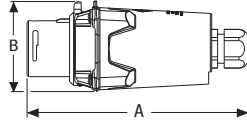

PRODUCT	A	B
DXN20	6.36	2.40
DXN30	6.47	2.83
DXN60	9.67	3.02

Inlet

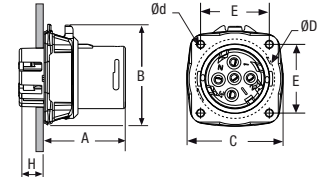

PRODUCT	A	C	E	H	Ød	ØD
DXN20	1.86	2.20	1.65	0.71	0.18	1.65
DXN30	1.97	2.63	1.89	1.06	0.19	2.18
DXN60	2.19	3.00	2.17	1.75	0.20	2.25

30° inclined inlet/angle with connector

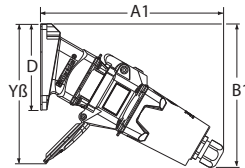

PRODUCT	A1	B1	D	YB
DXN20	7.52	5.91	3.54	5.75
DXN30	8.07	6.57	4.25	6.10
DXN60	9.41	7.48	4.00	9.02

30° inlet/angle

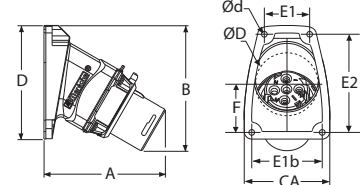

PRODUCT	A	B	CA	D	E1	E1b	E2	Ød	ØD
DXN20	3.74	3.94	2.68	3.54	1.42	1.42	3.07	0.18	2.00
DXN30	3.90	4.53	3.00	4.25	2.48	2.48	3.74	0.22	2.50
DXN60	4.29	4.88	3.00	4.25	2.48	2.48	3.74	0.22	2.50

30° inclined inlet/conduit box with connector

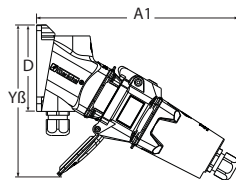

PRODUCT	A1	D	YB
DXN20	8.23	3.54	6.22
DXN30	8.70	4.25	7.80
DXN60	10.43	4.25	8.43

30° inlet/conduit box

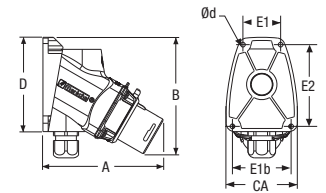

PRODUCT	A	B	CA	D	E1	E1b	E2	Ød
DXN20	4.53	4.37	2.68	3.54	1.42	2.20	3.07	0.18
DXN30	4.53	4.29	3.00	4.25	2.50		3.76	0.22
DXN60	5.35	5.04	3.00	4.25	2.50		3.76	0.22

70° inclined inlet/wall box with connector

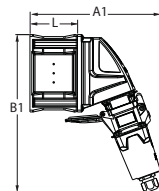

PRODUCT	A1	B1	L
DXN20	8.43	10.16	3.07
DXN30	8.62	10.90	3.07
DXN60	9.88	13.66	3.07

70° inlet/wall box

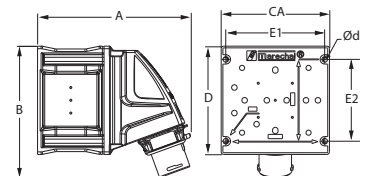

PRODUCT	A	B	CA	D	E1	E2	Ød
DXN20	7.05	6.06	4.97	4.97	4.57	3.78	0.26
DXN30	7.20	6.26	5.04	5.04	4.57	3.72	0.26
DXN60	8.27	7.99	6.69	6.69	6.14	5.43	0.26

Dimensions

Receptacle – Provided in inches

Dimensions are for reference only and may change depending on accessories used. For precise dimensions contact Meltric Engineering.

connector

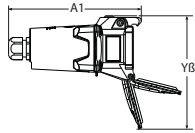

PRODUCT	A1	YB
DXN20	6.22	5.28
DXN30	7.17	7.05
DXN60	8.31	7.68

receptacle with plug

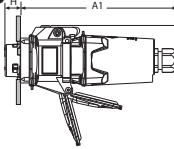

PRODUCT	A1	H
DXN20	6.50	0.68
DXN30	7.24	1.17
DXN60	8.58	1.18

receptacle

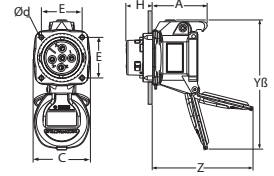

PRODUCT	A	C	E	H	YB	Z	Ød
DXN20	2.60	2.19	1.65	0.68	5.28	4.09	0.18
DXN30	2.93	2.60	1.89	1.20	7.05	4.29	0.20
DXN60	3.11	3.31	2.17	1.27	7.68	5.91	0.20

30° inclined receptacle/angle with plug

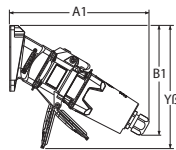

PRODUCT	A1	B1	YB
DXN20	7.52	5.91	6.65
DXN30	8.07	6.57	7.68
DXN60	9.41	7.48	8.62

30° receptacle/angle

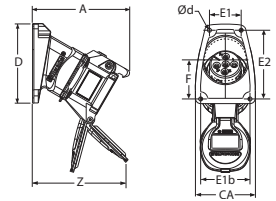

PRODUCT	A	CA	D	E1	E1b	E2	F	Z	Ød
DXN20	4.37	2.68	3.54	1.42	2.20	1.50	1.73	4.29	0.18
DXN30	5.08	3.03	4.25	2.50		2.75	1.46	4.64	0.23
DXN60	5.35	3.03	4.25	2.50		3.74	1.57	5.47	0.22

30° inclined receptacle/conduit box with plug

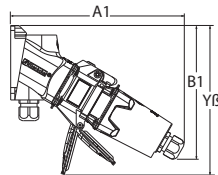

PRODUCT	A1	B1	YB
DXN20	8.23	6.38	7.09
DXN30	8.70	6.34	7.44
DXN60	10.43	7.68	8.86

30° receptacle/conduit box

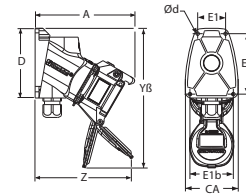

PRODUCT	A	CA	D	E1	E1b	E2	Z	Ød
DXN20	5.08	2.68	3.54	1.42	2.20	3.07	5.00	0.18
DXN30	5.71	3.24	3.25	2.50		3.75	6.30	0.22
DXN60	6.38	3.50	3.94	2.50		3.75	6.50	0.22

70° inclined receptacle/wall box with plug

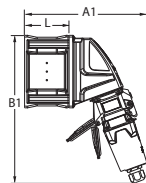

PRODUCT	A1	B1	L
DXN20	8.43	10.16	3.07
DXN30	8.43	10.91	3.07
DXN60	9.80	13.66	3.07

70° receptacle/wall box

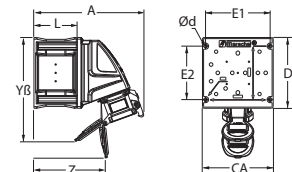

PRODUCT	A	CA	D	E1	E2	L	YB	Z	Ød
DXN20	7.80	4.97	4.97	4.57	3.78	3.07	7.36	5.20	0.26
DXN30	8.27	5.04	5.04	4.57	3.78	3.07	6.97	5.50	0.26
DXN60	9.21	6.69	6.69	6.14	5.47	3.07	9.45	5.75	0.26

DX



Features and Ratings	p. 82
Certifications and Testing	p. 83
DX Operation	p. 84
DX20	p. 85
DX30	p. 86
DX60	p. 87
DX100	p. 88
Dimensions	p. 89

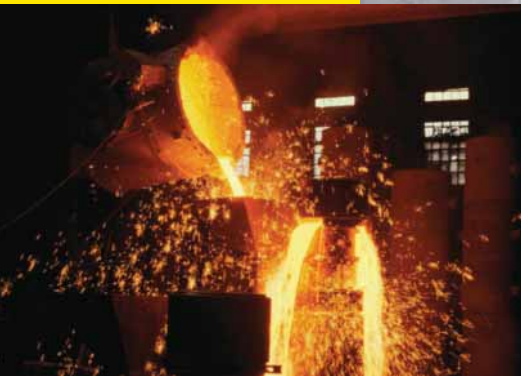

Hazardous duty rated plugs and receptacles

DX Series plugs and receptacles are heavy duty metallic devices that are a good choice for refineries, petroleum platforms, chemical and pharmaceutical plants, grain silos and other locations where exposure to flammable gases and/or dusts is likely to occur. DX's are ATEX rated and they have also been tested and approved by ETL for operation under load in a gaseous environment (14.5% acetylene). This is one of the key performance tests required for UL Class 1, Division 1 products.

Main Advantages

- ▶ Rugged Construction, cost effective design
- ▶ Rated for Zone 1 and Zone 21 applications

Product Features

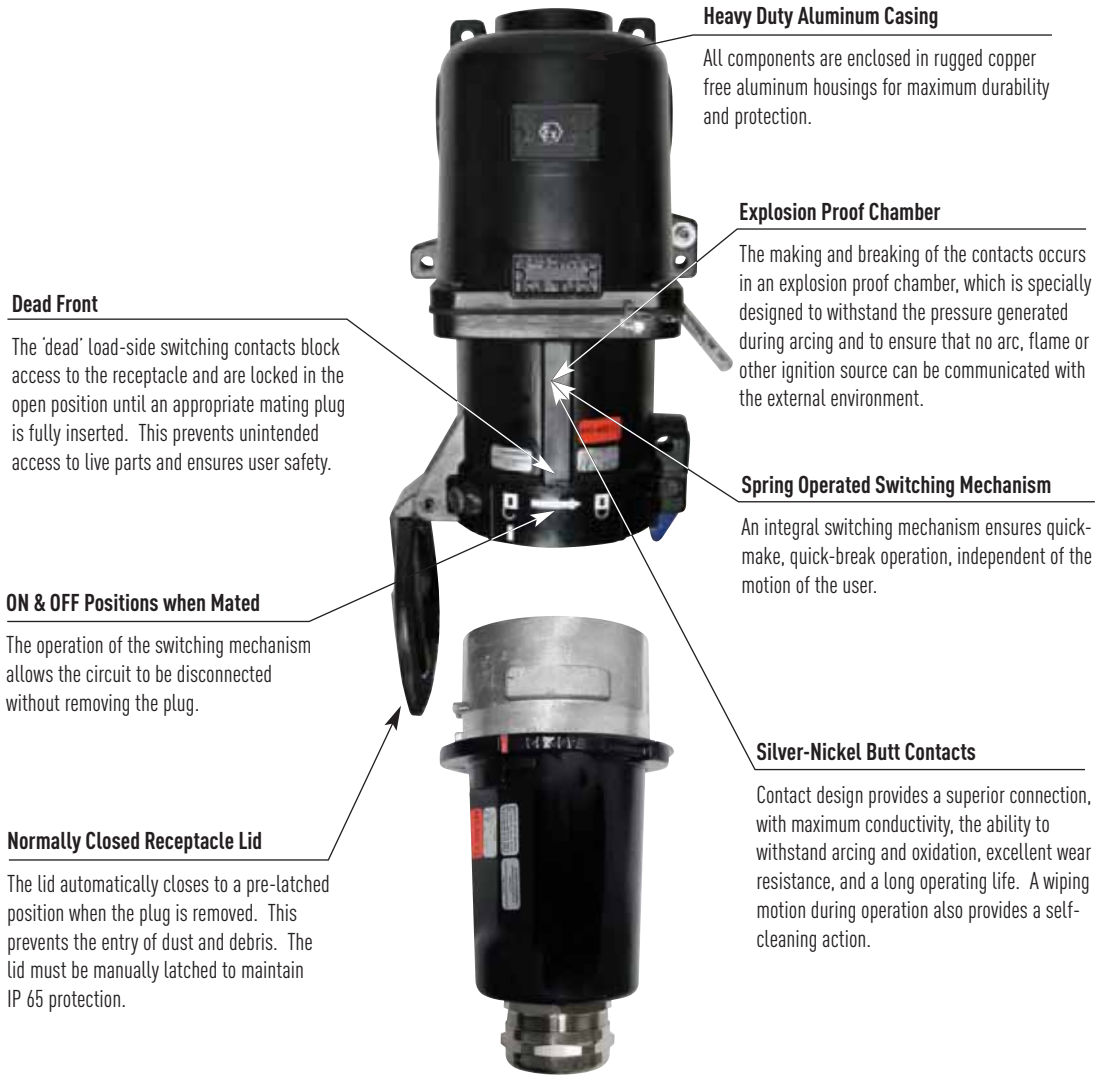

Heavy Duty Aluminum Casing
All components are enclosed in rugged copper free aluminum housings for maximum durability and protection.

Explosion Proof Chamber
The making and breaking of the contacts occurs in an explosion proof chamber, which is specially designed to withstand the pressure generated during arcing and to ensure that no arc, flame or other ignition source can be communicated with the external environment.

Spring Operated Switching Mechanism
An integral switching mechanism ensures quick-make, quick-break operation, independent of the motion of the user.

Silver-Nickel Butt Contacts
Contact design provides a superior connection, with maximum conductivity, the ability to withstand arcing and oxidation, excellent wear resistance, and a long operating life. A wiping motion during operation also provides a self-cleaning action.

Dead Front
The 'dead' load-side switching contacts block access to the receptacle and are locked in the open position until an appropriate mating plug is fully inserted. This prevents unintended access to live parts and ensures user safety.

ON & OFF Positions when Mated
The operation of the switching mechanism allows the circuit to be disconnected without removing the plug.

Normally Closed Receptacle Lid
The lid automatically closes to a pre-latched position when the plug is removed. This prevents the entry of dust and debris. The lid must be manually latched to maintain IP 65 protection.

Operating Instructions



When a DX is connected there is total safety.



Pressing the pawl while turning the plug about 30° counterclockwise causes the circuit to be broken.



Press the pawl while withdrawing the plug from the receptacle. This is done in complete safety because the circuit is already dead.

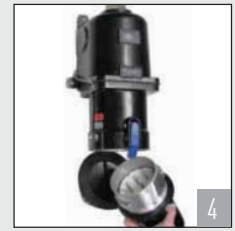

The plug and receptacle are separated. The safety shutter prevents access to live parts.

5 To reconnect, insert plug into receptacle fully, then twist the plug approximately 30° clockwise to make the circuit.

General Ratings

Amperage	20 to 100A
Voltage	600 VAC Max
Frequency	50-400 Hz
Environmental	IP65
Temperature	min -13°F/max 140°F* (DX20/DX30) min -40°F/max 140°F* (DX60/DX100)

Highlighted Feature

Dead Front

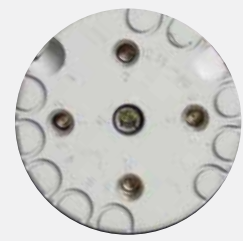

The dead front on the DX receptacle provides protection from accidental tool and wire insertion.

DX Certifications

Hazardous Duty Certification

ATEX

II 2 G/D DUST T85°C* Ex de IIC T6*

- II** – Indicates suitability for installation in surface applications (as opposed to underground mine applications).
- 2** – Indicates suitability for use where a high level of protection is required and where the presence of an explosive atmosphere is likely to occur (Zone 1 and Zone 21 environments).
- G/D** – Indicates suitability for installation in areas that may contain flammable gases, vapors/mists, or dusts.
- T85°C*** – Indicates a maximum surface temperature of the product of 85°C, at 40°C ambient.
- Ex de** – Indicates that explosion protection is provided with (e) increased safety in the conductor termination area, and (d) explosion proof chambers for making and breaking the current that can withstand the pressure of internal ignition and that prevent arcs, flame or other ignition events from being communicated to the surrounding atmosphere.
- IIC** – Indicates suitability for installation in areas where exposure to any type of gas, including the most dangerous subdivision C gases may occur.
- T6*** – Temperature class – the maximum product surface temperature is 185°F (85°C) for ambient temperature of 104°F (40°C).

ATEX & IECEx certification was performed by LCIE.

* Temperature ratings vary depending on product and ambient temperature. See specific product section for temperature ratings.

Electrical Performance Testing

Model	Key Performance Tests Passed			
	Mechanical Endurance	Electrical Endurance ¹	Overload Testing ²	Dielectric Test
DX20	-	5000 Operations	50 Operations	2 x V (rated) + 1000V
DX30	1000 Cycles	1000 Operations	50 Operations	2 x V (rated) + 1000V
DX60	1000 Cycles	1000 Operations	50 Operations	2 x V (rated) + 1000V
DX100	1000 Cycles	1000 Operations	50 Operations	2 x V (rated) + 1000V

¹ @ 100% of rated current and voltage and 0.6 power factor

² @ 125% of rated current, 110% of rated voltage, & 0.6 power factor

DX Operation

Connection

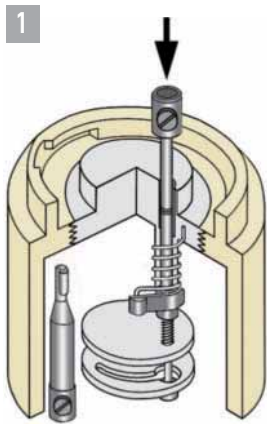

Insertion of the Plug

As the plug contact is inserted, it engages and depresses the 'dead' switching contact.

This releases the locking mechanism. The switching contact is free to operate.

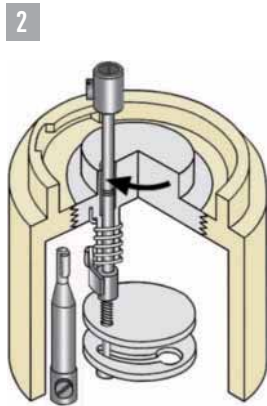

Charging the Operating Spring

Clockwise rotation of the inserted plug winds the operating spring and rotates the switching contact into position to engage with the live receptacle contact.

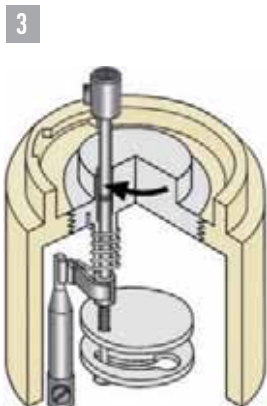

Making the Circuit

With the final few degrees of rotation, the switching contact is released and force from the spring quickly drives it into engagement with the live receptacle contact.

Disconnection

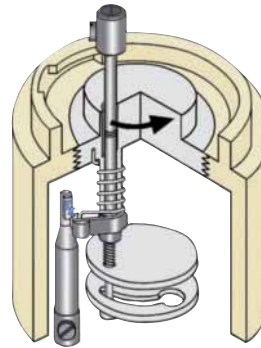

After depressing the pawl, the plug is rotated in a counter-clockwise direction. This frees the switching contact for operation and the release of the remaining spring tension causes a quick breaking of the contacts. The plug may now be removed, if desired.

Receptacle with Plug Disconnected

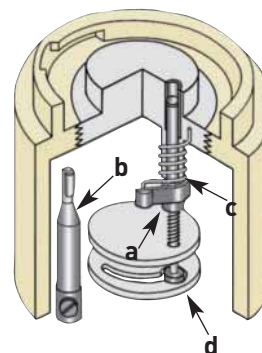

- a. **Switching Contact**
Shown in the open (dead) position
- b. **'Live' Receptacle Contact**
Accessibility is denied
- c. **Operating Spring**
Shown with tension released
- d. **Mechanical Locking Device**
Blocks contact operation

DX20



DX – 20A

Hazardous Location Plugs & Receptacles

Ratings

- **Voltage**
600 VAC
- **Environmental Ratings**
IP65
- **Temperature Range**
Min -13°F / Max 140°F
- **Wiring Capacity**
Min 14 AWG Max 6 AWG
* Based on THHN wire sizes
- **Listings**
ATEX, IECEx
- **DX20 Ratings Label**

MARECHAL ELECTRIC MAROMME
 © I12 G/D Ex de IIC tD A21
 -25°C ≤ Ta ≤ +60°C T5 T84°C
 -25°C ≤ Ta ≤ +50°C T6 T74°C
 IECEx LCI 09.0014 / LCIE 05 ATEX 6127

XXX Suffix / Cable Range

XXX (Suffix #)	Cable Range
-20M	.31" - .51"
-32M	.47" - .82"

XX Suffix / NPT Size

NPT Thread Size	XX (Suffix #)
1/2"	-12
3/4"	-34
1"	-1

NPT sizes are determined by the cable diameter and third party cord grip.

Accessories



Protective Cap

For Male Devices Only

Part #



Surface Box

NPT

Part #

1/2" 26-2A023-12

3/4" 26-2A023-34

1" 26-2A023-1

Plug (male inlet w/handle)



Replace XXX or XX with suffix number to indicate desired cable range (see chart)

Voltage	Polarity	Part # Metal
125V	1P+N+G	26-21075-XXX
208V	2P+G	26-21162-XXX
208V	3P+G	26-21163-XXX
208V	3P+N+G	26-21167-XXX
250V	2P+G	26-21072-XXX
250V	3P+G	26-21073-XXX
250V	2P+N+G	26-21076-XXX
277V	1P+N+G	26-21045-XXX
480V	2P+G	26-21042-XXX
480V	3P+G	26-21043-XXX
480V	3P+N+G	26-21047-XXX
600V	3P+G	26-21143-XXX

Inlet w/cap on box (male)



or

Voltage	Polarity	Part # Metal
125V	1P+N+G	26-26075-XX
208V	2P+G	26-26162-XX
208V	3P+G	26-26163-XX
208V	3P+N+G	26-26167-XX
250V	2P+G	26-26072-XX
250V	3P+G	26-26073-XX
250V	2P+N+G	26-26076-XX
277V	1P+N+G	26-26045-XX
480V	2P+G	26-26042-XX
480V	3P+G	26-26043-XX
480V	3P+N+G	26-26047-XX
600V	3P+G	26-26143-XX

Other voltage configurations are available – contact customer service at 800.433.7642.

Connector Receptacle on box Receptacle (female recept w/handle) (female) (female)



or



or



Voltage	Polarity	Part # Metal	Part # Metal	Part # Metal
125V	1P+N+G	26-23075-XXX	26-20075-XX	26-24075
208V	2P+G	26-23162-XXX	26-20162-XX	26-24162
208V	3P+G	26-23163-XXX	26-20163-XX	26-24163
208V	3P+N+G	26-23167-XXX	26-20167-XX	26-24167
250V	2P+G	26-23072-XXX	26-20072-XX	26-24072
250V	3P+G	26-23073-XXX	26-20073-XX	26-24073
250V	2P+N+G	26-23076-XXX	26-20076-XX	26-24076
277V	1P+N+G	26-23045-XXX	26-20045-XX	26-24045
480V	2P+G	26-23042-XXX	26-20042-XX	26-24042
480V	3P+G	26-23043-XXX	26-20043-XX	26-24043
480V	3P+N+G	26-23047-XXX	26-20047-XX	26-24047
600V	3P+G	26-23143-XXX	26-20143-XX	26-24143

Other voltage configurations are available – contact customer service at 800.433.7642.

DX – 30A

Hazardous Location Plugs & Receptacles

Plug (male inlet w/handle)



Replace XXX or XX with suffix number to indicate desired cable range (see chart)

Voltage	Polarity	Part # Metal
125V	1P+N+G	26-31075-XXX
208V	2P+G	26-31162-XXX
208V	3P+G	26-31163-XXX
208V	3P+N+G	26-31167-XXX
250V	2P+G	26-31072-XXX
250V	3P+G	26-31073-XXX
250V	2P+N+G	26-31076-XXX
277V	1P+N+G	26-31045-XXX
480V	2P+G	26-31042-XXX
480V	3P+G	26-31043-XXX
480V	3P+N+G	26-31047-XXX
600V	3P+G	26-31143-XXX

Inlet w/cap on box (male)



or

Voltage	Polarity	Part # Metal
125V	1P+N+G	26-36075-XX
208V	2P+G	26-36162-XX
208V	3P+G	26-36163-XX
208V	3P+N+G	26-36167-XX
250V	2P+G	26-36072-XX
250V	3P+G	26-36073-XX
250V	2P+N+G	26-36076-XX
277V	1P+N+G	26-36045-XX
480V	2P+G	26-36042-XX
480V	3P+G	26-36043-XX
480V	3P+N+G	26-36047-XX
600V	3P+G	26-36143-XX

Other voltage configurations are available – contact customer service at 800.433.7642.

Connector (female recept w/handle) Receptacle on box (female) Receptacle (female)



or



or



Voltage	Polarity	Part # Metal	Part # Metal	Part # Metal
125V	1P+N+G	26-33075-XXX	26-30075-XX	26-34075
208V	2P+G	26-33162-XXX	26-30162-XX	26-34162
208V	3P+G	26-33163-XXX	26-30163-XX	26-34163
208V	3P+N+G	26-33167-XXX	26-30167-XX	26-34167
250V	2P+G	26-33072-XXX	26-30072-XX	26-34072
250V	3P+G	26-33073-XXX	26-30073-XX	26-34073
250V	2P+N+G	26-33076-XXX	26-30076-XX	26-34076
277V	1P+N+G	26-33045-XXX	26-30045-XX	26-34045
480V	2P+G	26-33042-XXX	26-30042-XX	26-34042
480V	3P+G	26-33043-XXX	26-30043-XX	26-34043
480V	3P+N+G	26-33047-XXX	26-30047-XX	26-34047
600V	3P+G	26-33143-XXX	26-30143-XX	26-34143

Other voltage configurations are available – contact customer service at 800.433.7642.

Ratings

- **Voltage**
600 VAC
- **Environmental Ratings**
IP65
- **Temperature Range**
Min -13°F / Max 140°F
- **Wiring Capacity**
Min 14 AWG Max 6 AWG
* Based on THHN wire sizes
- **Listings**
ATEX, IECEx
- **DX30 Ratings Label**

MARECHAL ELECTRIC MAROMME
 Ⓢ I12 G/D Ex de IIC tD A21
 -25°C ≤ Ta ≤ +60°C T5 T84°C
 -25°C ≤ Ta ≤ +50°C T6 T74°C
 IECEx LCI 09.0014 / LCIE 05 ATEX 6127

XXX Suffix / Cable Range

XXX (Suffix #)	Cable Range
-20M	.31" - .51"
-32M	.47" - .82"

XX Suffix / NPT Size

NPT Thread Size	XX (Suffix #)
1/2"	-12
3/4"	-34
1"	-1

NPT sizes are determined by the cable diameter and third party cord grip.

Accessories

	Protective Cap
For Male Devices Only	Part #
DX30	26-3A126
	Surface Box
NPT	Part #
1/2"	26-3A023-12
3/4"	26-3A023-34
1"	26-3A023-1

DX60



DX - 60A

Hazardous Location Plugs & Receptacles

Ratings

- Voltage**
600 VAC
- Environmental Ratings**
IP65
- Temperature Range**
Min -40°F / Max 140°F
- Wiring Capacity**
Min 8 AWG Max 2 AWG
* Based on THHN wire sizes
- Listings**
ATEX + IECEx
- DX60 Ratings Label**

MARECHAL ELECTRIC MAROMME
 © I12 G/D Ex de IIC tD A21
 -40°C ≤ Ta ≤ +60°C T5 T90°C
 -40°C ≤ Ta ≤ +50°C T6 T80°C
 IECEx LCI 09.0015 / LCIE 04 ATEX 6038

XXX Suffix / Cable Range

XXX (Suffix #)	Cable Range
-25M	.35" - .63"
-40M	.63" - 1.05"

XX Suffix / NPT Size

NPT Thread Size	XX (Suffix #)
1"	-1
1 1/4"	-114
1 1/2"	-112
2"	-2

NPT sizes are determined by the cable diameter and third party cord grip.

Accessories



Protective Cap

For Male Devices Only

Part #

DX60 26-6A126



Metal Wall Box

NPT Part #

1" 26-6A023-1

1 1/4" 26-6A023-114

1 1/2" 26-6A023-112

2" 26-6A023-2

Plug (male inlet w/handle)



Replace XXX or XX with suffix number to indicate desired cable range (see chart)

Voltage	Polarity	Part # Metal
125V	1P+N+G	26-61075-XXX
208V	2P+G	26-61162-XXX
208V	3P+G	26-61163-XXX
208V	3P+N+G	26-61167-XXX
250V	2P+G	26-61072-XXX
250V	3P+G	26-61073-XXX
250V	2P+N+G	26-61076-XXX
277V	1P+N+G	26-61045-XXX
480V	2P+G	26-61042-XXX
480V	3P+G	26-61043-XXX
480V	3P+N+G	26-61047-XXX
600V	3P+G	26-61143-XXX

Inlet w/cap on box (male)



or

Voltage	Polarity	Part # Metal
125V	1P+N+G	26-66075-XX
208V	2P+G	26-66162-XX
208V	3P+G	26-66163-XX
208V	3P+N+G	26-66167-XX
250V	2P+G	26-66072-XX
250V	3P+G	26-66073-XX
250V	2P+N+G	26-66076-XX
277V	1P+N+G	26-66045-XX
480V	2P+G	26-66042-XX
480V	3P+G	26-66043-XX
480V	3P+N+G	26-66047-XX
600V	3P+G	26-66143-XX

Other voltage configurations are available - contact customer service at 800.433.7642.

Connector Receptacle on box Receptacle

(female recept w/handle) (female) (female)



or



or



Voltage	Polarity	Part # Metal	Part # Metal	Part # Metal
125V	1P+N+G	26-63075-XXX	26-60075-XX	26-64075
208V	2P+G	26-63162-XXX	26-60162-XX	26-64162
208V	3P+G	26-63163-XXX	26-60163-XX	26-64163
208V	3P+N+G	26-63167-XXX	26-60167-XX	26-64167
250V	2P+G	26-63072-XXX	26-60072-XX	26-64072
250V	3P+G	26-63073-XXX	26-60073-XX	26-64073
250V	2P+N+G	26-63076-XXX	26-60076-XX	26-64076
277V	1P+N+G	26-63045-XXX	26-60045-XX	26-64045
480V	2P+G	26-63042-XXX	26-60042-XX	26-64042
480V	3P+G	26-63043-XXX	26-60043-XX	26-64043
480V	3P+N+G	26-63047-XXX	26-60047-XX	26-64047
600V	3P+G	26-63143-XXX	26-60143-XX	26-64143

Other voltage configurations are available - contact customer service at 800.433.7642.

DX – 100A

Hazardous Location Plugs & Receptacles

Plug (male inlet w/handle)



Replace XXX or XX with suffix number to indicate desired cable range (see chart)

Voltage	Polarity	Part # Metal
125V	1P+N+G	26-91075-XXX
208V	2P+G	26-91162-XXX
208V	3P+G	26-91163-XXX
208V	3P+N+G	26-91167-XXX
250V	2P+G	26-91072-XXX
250V	3P+G	26-91073-XXX
250V	2P+N+G	26-91076-XXX
277V	1P+N+G	26-91045-XXX
480V	2P+G	26-91042-XXX
480V	3P+G	26-91043-XXX
480V	3P+N+G	26-91047-XXX
600V	3P+G	26-91143-XXX

Inlet w/cap on box (male)



or

Voltage	Polarity	Part # Metal
125V	1P+N+G	26-96075-XX
208V	2P+G	26-96162-XX
208V	3P+G	26-96163-XX
208V	3P+N+G	26-96167-XX
250V	2P+G	26-96072-XX
250V	3P+G	26-96073-XX
250V	2P+N+G	26-96076-XX
277V	1P+N+G	26-96045-XX
480V	2P+G	26-96042-XX
480V	3P+G	26-96043-XX
480V	3P+N+G	26-96047-XX
600V	3P+G	26-96143-XX

Other voltage configurations are available – contact customer service at 800.433.7642.

Connector (female recept w/handle)



Receptacle on box (female)



or

or

Receptacle (female)



Voltage	Polarity	Part # Metal	Part # Metal	Part # Metal
125V	1P+N+G	26-93075-XXX	26-90075-XX	26-94075
208V	2P+G	26-93162-XXX	26-90162-XX	26-94162
208V	3P+G	26-93163-XXX	26-90163-XX	26-94163
208V	3P+N+G	26-93167-XXX	26-90167-XX	26-94167
250V	2P+G	26-93072-XXX	26-90072-XX	26-94072
250V	3P+G	26-93073-XXX	26-90073-XX	26-94073
250V	2P+N+G	26-93076-XXX	26-90076-XX	26-94076
277V	1P+N+G	26-93045-XXX	26-90045-XX	26-94045
480V	2P+G	26-93042-XXX	26-90042-XX	26-94042
480V	3P+G	26-93043-XXX	26-90043-XX	26-94043
480V	3P+N+G	26-93047-XXX	26-90047-XX	26-94047
600V	3P+G	26-93143-XXX	26-90143-XX	26-94143

Other voltage configurations are available – contact customer service at 800.433.7642.

Ratings

- **Voltage**
600 VAC
- **Environmental Ratings**
IP65
- **Temperature Range**
Min -40°F / Max 140°F
- **Wiring Capacity**
Min 4 AWG Max 2 AWG
* Based on THHN wire sizes
- **Listings**
ATEX
- **DX100 Ratings Label**

MARECHAL ELECTRIC MAROMME
 Ⓢ I12 G/D Ex de IIC tD A21
 -40°C ≤ Ta ≤ +60°C T5 T90°C
 -40°C ≤ Ta ≤ +50°C T6 T80°C
 IECEx LCI 09.0015 / LCIE 04 ATEX 6038

XXX Suffix / Cable Range



XXX (Suffix #)	Cable Range
-25M	.35" - .63"
-40M	.63" - 1.05"
-50M	.91" - 1.38"
-63M	1.42" - 1.89"

XX Suffix / NPT Size

NPT Thread Size	XX (Suffix #)
1"	-1
1 1/4"	-114
1 1/2"	-112
2"	-2

NPT sizes are determined by the cable diameter and third party cord grip.

Accessories

	Protective Cap
<i>For Male Devices Only</i>	
Part #	
DX100	26-9A126
	Metal Wall Box
NPT	Part #
1"	26-9A023-1
1 1/4"	26-9A023-114
1 1/2"	26-9A023-112
2"	26-9A023-2

DX



Dimensions

Inlet – Provided in inches

Dimensions are for reference only and may change depending on accessories used. For precise dimensions contact Meltric Engineering.

plug

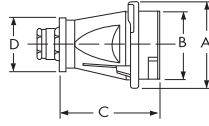

PRODUCT	A	B	C	D
DX20/DX30	4.06	3.19	4.65	2.68
DX60/DX100	5.75	4.65	8.66	3.94

Inlet + Connector

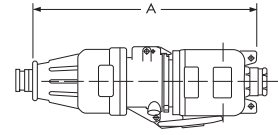

PRODUCT	A
DX20/DX30	15.94
DX60/DX100	24.88

Dimensions

Receptacle – Provided in inches

Dimensions are for reference only and may change depending on accessories used. For precise dimensions contact Meltric Engineering.

connector + plug

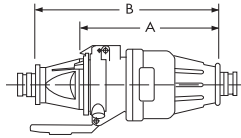

PRODUCT	A	B
DX20/DX30	9.65	12.68
DX60/DX100	16.06	21.14

receptacle + plug

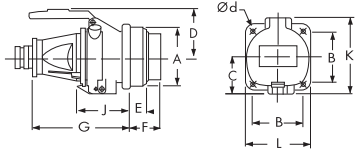

PRODUCT	A	B	C	D	E	F	G	J	K	L	Ød
DX20/DX30	4.09	3.62	2.60	3.35	1.14	2.17	6.77	3.74	5.39	4.61	0.26
DX60/DX100	5.83	4.80	3.62	4.33	1.06	3.54	11.89	6.81	7.28	6.30	0.35

receptacle/box + plug

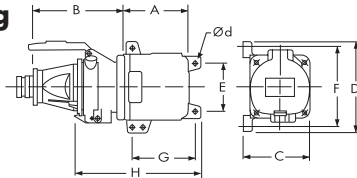

PRODUCT	A	B	C	D	E	F	G	H	Ød
DX20/DX30	4.76	6.77	4.76	6.57	3.54	5.71	4.69	9.45	.35
DX60/DX100	7.17	11.89	6.50	8.70	5.12	7.68	6.85	14.88	.39

MULTIPLIN DXN25c/DXN37c

Product Features



Locking Provision

For insertion of locking pin (or padlock) to prevent inadvertent disconnection

Metal Casing

Provides excellent durability and protection.

Lid

Provides additional protection from harsh environments.

Silver-Nickel Contacts

Silver-nickel contact material provides superior conductivity, durability and corrosion resistance.

Recessed Contacts

Provides IP2X protection from live electrical parts.

Spring Loaded Butt-Style Contacts

Ensures optimal contact force and superior electrical performance over thousands of operations.

IP66+IP67 Watertightness

Environmental rating is achieved as soon as the plug is latched to the receptacle. There is no additional ring to tighten.

Hazardous Duty Listings

ATEX

II 2 G/D Ex e II tD A21 IP66/IP67
Suitable for Zone 1 & 2 (gas) 21 & 22 (dust)

DXN25c $-40^{\circ}\text{C} \leq \text{Ta} \leq 60^{\circ}\text{C}$ T5 T71°C
 $-40^{\circ}\text{C} \leq \text{Ta} \leq 40^{\circ}\text{C}$ T6 T51 °C

DXN37c $-40^{\circ}\text{C} \leq \text{Ta} \leq 55^{\circ}\text{C}$ T5 T76°C
 $-40^{\circ}\text{C} \leq \text{Ta} \leq 40^{\circ}\text{C}$ T6 T56 °C

Highlighted Feature

DXN25c and DXN37c Contact



male contact

female contact

DXN25c and DXN37c devices feature silver-nickel, spring-loaded, butt-style contacts for superior durability and electrical performance. Terminals are solder type.



DXN25c / DXN37c – 10A

Hazardous Location Plugs & Receptacles

Connector (female receptacle w/handle) **Receptacle w/angle** (female) **Receptacle/Angle/Box** (female)



or



or



Voltage	Polarity	Part # Metal	Part # Metal	Part # Metal
440V	24P+G	36-N3241-40M	36-N7241	36-N0241-40M
220V	36P+G	36-M3361-XXX	36-M7361	36-M0361-XXX

Plug (male inlet w/handle)



or

Inlet w/angle (male)



or

Inlet/Angle/Box (male)



Voltage	Polarity	Part # Metal	Part # Metal	Part # Metal
440V	24P+G	36-N1241-40M	36-N9241	36-N6241-40M
220V	36P+G	36-M1361-XXX	36-M9361	36-M6361-XXX

Ratings

- Voltage**
440 VAC DXN25c
220 VAC DXN37c
- Amperage Ratings**
10A DXN25c Not for disconnection of a live circuit
10A DXN37c Not for disconnection of a live circuit
- Environmental Ratings**
IP66+IP67
- Temperature Range**
Min -40°F/Max 140°F – (DXN25c)
Min -40°F/Max 131°F – (DXN37c)
- Wiring Capacity**
Min 16 AWG Max 14 AWG
* Based on THHN wiring connection type solder
- Terminal Type**
Solder
- Listings**
ATEX

XXX Suffix / Cable Range

XXX (Suffix #)	Cable Range
-32M	.50 - .825
-40M	.63 - 1.05

Dimensions

Receptacle – Provided in inches

Dimensions are for reference only and may change depending on accessories used. For precise dimensions contact Meltric Engineering.

connector

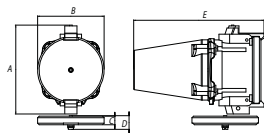

PRODUCT	A	B	C	D	E
DXN25c/37c	4.49	3.35	.43	.71	6.57

plug

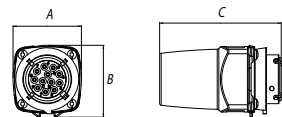

PRODUCT	A	B	C
DXN25c/37c	3.43	3.19	5.83

receptacle / angle / junction box

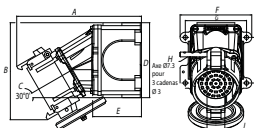

PRODUCT	A	B	C	D	E	F	G	H	I	J
DXN25c/37c	7.52	5.87		4.53	2.95	4.33	3.7		2.76	1.06

receptacle / box + plug

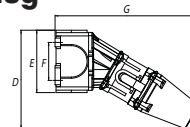

PRODUCT	A	B	C	D	E	F	G
DXN25c/37c	4.49	4.33	3.70	7.13	4.53	2.76	10.43

MULTIPLIN PXN12c

Product Features



Metal Casing

Provides excellent durability and protection.

IP65+IP66 Watertightness

Environmental rating is achieved as soon as the plug is latched to the receptacle. There is no additional rings to tighten.

Lid

Provides additional protection from harsh environments.

Recessed Contacts

Provides IP2X protection from live electrical parts.

Locking Provision

Turn triangular screw with special tool (provided) to prevent plug removal.

Spring Loaded Butt-Style Contacts

Ensures optimal contact force and superior electrical performance over thousands of operations.

Silver-Nickel Contacts

Silver-nickel contact material provides superior conductivity, durability and corrosion resistance.

Hazardous Duty Listings

ATEX

II 2 G/D Ex e II tD A21 IP65
Suitable for Zone 1 & 2 (gas) 21 & 22 (dust)

5A: -40 °C <Ta<+60 °C T6 T65 °C

10A: -40 °C <Ta<+55 °C T5 T69 °C

Highlighted Feature

PXN12c Contact



male contact

female contact

PXN12c devices feature silver-nickel, spring-loaded, butt-style contacts for superior durability and electrical performance. Terminals are solder type.



PXN12c Multipin – 10A

Hazardous Location Plugs & Receptacles

Connector
(female receptacle w/handle)



Receptacle w/angle (female) **or** **Receptacle/Angle/Box** (female)



Voltage	Polarity	Part # Metal	Part # Metal	Part # Metal
220V	11P+G	06-M3111-XXX	06-M7111	06-M0111-XXX

Plug
(male inlet w/handle)



Inlet w/angle (male) **or** **Inlet/Angle/Box** (male)



Voltage	Polarity	Part # Metal	Part # Metal	Part # Metal
220V	11P+G	06-M1111-XXX	06-M9111	06-M6111-XXX

Ratings

- **Voltage**
220 VAC
- **Amperage Ratings**
10A Not for disconnection of a live circuit
- **Environmental Ratings**
IP65+IP66
- **Temperature Range**
Min -40°F / Max 140°F
- **Wiring Capacity**
Min 16 AWG Max 14 AWG
* Based on THHN wiring connection type solder
- **Terminal Type**
Solder
- **Listings**
ATEX

XXX Suffix / Cable Range

XXX (Suffix #)	Cable Range
-32M	.47 - .82
-25M	.35 - .63

Dimensions

Receptacle – Provided in inches

Dimensions are for reference only and may change depending on accessories used. For precise dimensions contact Meltric Engineering.

plug

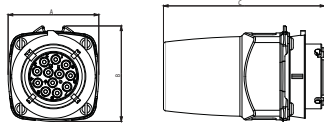

PRODUCT	A	B	C
PXN12c	2.28	2.40	4.09

receptacle / angle / junction box

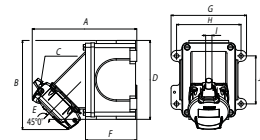

PRODUCT	A	B	C	D	E	F	G	H	I	J
PXN12c	5.98	5.12	4.53	2.95	4.33	3.70	.36	2.76		

Product Features



Hazardous Duty Listings

ATEX

Ⓔ II 2 G D Ex e IIC T* Gb Ex t IIC T* Db IP65/IP66
 Suitable for Zone 1 & 2 (gas) 21 & 22 (dust)
 -20°C ≤ Ta ≤ 40°C T5 T56°C
 -20°C ≤ Ta ≤ 60°C T5 T76°C
 -20°C ≤ Ta ≤ 40°C T6 T56°C
 -20°C ≤ Ta ≤ +60°C T4 T79°C



Amperage Ratings by Cable Size and ATEX Rating

	-20°C ≤ Ta ≤ 40°C G/D T5/T56°C	-20°C ≤ Ta ≤ 40°C G/D T6/T56°C	-20°C ≤ Ta ≤ 60°C G/D T5/T76°C
70mm ²	290A	235A	235A
95mm ²	415A	335A	335A
120mm ²	456A	376A	376A
150mm ²	493A	415A	415A
185mm ²	530A	450A	450A
240mm ²	570A	497A	497A
300mm ²	620A	540A	540A
400mm ²	680A	600A	600A

SPeX

Hazardous Duty Plugs & Receptacles

Plug (male inlet w/handle)



Receptacle on Angle (female)



Ratings

- **Voltage**
1000 VAC
- **Amperage Ratings**
See table page 95
- **Environmental Ratings**
IP65/IP66
- **Temperature Range**
See table page 95
- **Wiring Capacity**
Min 2/0 AWG Max 750 MCM
Aux Contacts 12-14 AWG
See table page 95
- **Listings**
ATEX, IECEx

Color Code	Polarity	Part # without lug (by cable diameter)				Color Code	Polarity	Part # without lug
		.70-.98 in	.94-1.33 in	1.33-1.65 in	1.57-1.89 in			
Black	L1	42-41001-32P	42-41001-40P	42-41001-50P	42-41001-63P	Black	L1	42-47001
Red	L2	42-41002-32P	42-41002-40P	42-41002-50P	42-41002-63P	Red	L2	42-47002
Blue	L3	42-41003-32P	42-41003-40P	42-41003-50P	42-41003-63P	Blue	L3	42-47003
White	NEUTRAL	42-4100N-32P	42-4100N-40P	42-4100N-50P	42-4100N-63P	White	NEUTRAL	42-4700N
Green	GROUND	42-4100T-32P	42-4100T-40P	42-4100T-50P	42-4100T-63P	Green	GROUND	42-4700T
Red	POSITIVE	42-4100P-32P	42-4100P-40P	42-4100P-50P	42-4100P-63P	Red	POSITIVE	42-4700P
Black	NEGATIVE	42-4100M-32P	42-4100M-40P	42-4100M-50P	42-4100M-63P	Black	NEGATIVE	42-4700M

Crimping lug*



Crimping lug*



Flexible MCM+ Wire Size	Straight with Terminal	Straight Threaded**	Flexible MCM+ Wire Size	Straight with Terminal	Straight Threaded**
4/0	45-4A95C	45-4A95D	4/0	45-4A95C	45-4A95D
250	45-4A12C	45-4A12D	250	45-4A12C	45-4A12D
300	45-4A15C	45-4A15D	300	45-4A15C	45-4A15D
350	45-4A18C	45-4A18D	350	45-4A18C	45-4A18D
500	45-4A24C	45-4A24D	500	45-4A24C	45-4A24D
600	45-4A30C	45-4A30D	600	45-4A30C	45-4A30D
777	45-4A40C	45-4A40D	777	45-4A40C	45-4A40D

* Use the straight threaded lug when cord mounting with handle accessory
 ** Straight threaded lug can be used for solder connection as well as crimp connection
 Lugs should be crimped using a dieless indent style crimping tool
 + Based on flexible type copper cables. See appropriate NEC tables for applicable ampacities

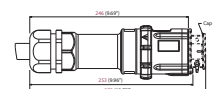

Dimensions see page 136

MULTIPIN

Summary and Specifications	p. 98
PN12c	p. 99
PN12c Stainless	p. 101
DSN24c	p. 103
DS24c Stainless	p. 105
DSN37c	p. 107
DS37c Stainless	p. 109
PN7c	p. 111
DN9c	p. 113
DN20c	p. 115
DN7c	p. 117
DS7c	p. 119
DR7c	p. 121



Superior contact technology maximizes durability and performance

Meltric offers a broad range of multipin devices for use in a wide variety of control and power applications. Devices are available with as many as 37 or as few as 4 contacts. Products range from 2A up to 150A and some include load making and breaking capabilities.

Main Advantages

- ▶ Spring-loaded, silver-nickel, butt-style contacts
- ▶ Robust casing materials made of fiberglass reinforced thermoplastic polyester, epoxy coated zamak, or stainless steel (depending on the model type and size).

Product Features

Product Line Summary

PN12c multipin plugs and receptacles are ideal for low amperage applications requiring compact devices. IP66+67 watertightness provides protection in washdown environments.

PN7c plugs and receptacles are excellent for use when between 5 and 7 contacts are required with amperages up to 20A.

DSN 24c/37c plugs and receptacles are excellent for frequent low ampacity connecting and disconnecting application. Up to 37 contacts are available on the device which is rated up to NEMA 4X/IP 66+67.

DN9c and DN20c devices are horsepower rated and allow multiple power circuits or a combination of power and control circuits in a single connection.

DN7c, DR7c, and DS7c multipins are excellent for those difficult, higher amperage environments where there is a need for frequent connecting and disconnecting. DS7c devices are current interrupting rated for up to 30 amps per contact, and like the DR7c allow the addition of up to 3 auxiliary contacts.



Multipin Product Specifications

Product Type	Housing Material	Voltage (Max)	Number of Contacts Min / Max		Amperage		Wiring Capacity Min / Max		Environmental Rating	Wiring Connection	Catalog Page
					Current Interrupting	Non-Current Interrupting					
PN12c	Polyester	600	1	11P+G	5	7.5	18 AWG	14 AWG	IP66+IP67	Solder/Crimp	99
PN12c	Metal	600	1	11P+G	5	7.5	18 AWG	14 AWG	IP66+IP67	Solder/Crimp	99
PN12c	Stainless	600	1	11P+G	5	7.5	18 AWG	14 AWG	-	Solder/Crimp	101
DSN24c	Polyester	480	1	24	2	7.5	18 AWG	14 AWG	IP66+IP67	Solder/Crimp	103
DS24c	Stainless	250	1	24	2	7.5	18 AWG	14 AWG	-	Solder/Crimp	105
DSN37c	Polyester	480	1	37	2	7.5	18 AWG	14 AWG	IP66+IP67	Solder/Crimp	107
DS37c	Stainless	480	1	37	2	7.5	18 AWG	14 AWG	-	Solder/Crimp	109
PN7c**	Polyester	600	4P+G	6P+G	15	20	18 AWG	10 AWG	IP66+IP67	Screw	111
PN7c**	Metal	600	4P+G	6P+G	15	20	18 AWG	10 AWG	IP66+IP67	Screw	111
PN7c	Stainless	600	4P+G	6P+G	15	20	18 AWG	10 AWG	-	Screw	111
DN9c	Metal	480	6	9	-	20	16 AWG	10 AWG	IP54/IP55*	Screw	113
DN20c	Metal	480	10	20	-	20*	16 AWG	10 AWG	IP54/IP55*	Screw	115
DN7c	Metal	480	6P+G	6P+G	-	50	10 AWG	6 AWG	IP54/IP55*	Screw	117
DN7c	Metal	480	6P+G	6P+G	-	90	6 AWG	2 AWG	IP54/IP55*	Screw	117
DN7c	Metal	480	6P+G	6P+G	-	150	6 AWG	2 AWG	IP54/IP55*	Screw	117
DS7c	Polyester	600	4	7	30	-	14 AWG	8 AWG	IP54/IP55*	Screw	119
DS7c	Metal	600	4	7	30	-	14 AWG	8 AWG	IP54/IP55*	Screw	119
DR7c	Polyester	600	4	7	-	50	14 AWG	8 AWG	IP54/IP55*	Screw	121
DR7c	Metal	600	4	7	-	50	14 AWG	8 AWG	IP54/IP55*	Screw	121

+ Rated IP54 when receptacle and plug are mated, when not mated receptacle alone is rated IP55 provided that the lid is latched closed.

* The rating is reduced to 15A when more than 12 contacts are used for power circuits (not control)

** UL 1682 Listed

PN12c



PN12c Multipin – 7.5A Plugs & Receptacles

Receptacle (female)

Inlet (male)



Don't forget to add installation accessories to your order



Ratings

- **Voltage**
600 VAC Max/130 VDC
- **Amperage Rating**
5A Current Interrupting
7.5A Non-Current Interrupting
! PN12c is capable of handling 4-20mA low current applications
- **Environmental Ratings**
IP66+IP67
- **Temperature Range**
Min -40°F / Max 140°F
See pg 220 for temps below -15°F.
- **Wiring Capacity**
Min 18 AWG Max 14 AWG
- **Listings**
CE*
* Contact Customer Service

For PN12c dimensions, see pgs 165-166

Voltage	Polarity	Part #	
		Poly	Metal
600V	11P+G	03-A4001	07-A4001

Voltage	Polarity	Part #	
		Poly	Metal
600V	11P+G	03-A8001	07-A8001

Simple Assembly and Disassembly

DSN37c shown



Assembly

To insert contacts when they have been wired is simple. Push wired contact into rear of insulator until it stops to complete the installation.



Disassembly

To remove, use the tool provided. Push tool from front onto contact until tool stops. Contact is then released at rear of insulator.

Receptacle Options	Part #
Reverse Interiors	Recept # - 001
With Flush Mount (poly only)	Recept # - 142
Locking Pawl	Recept # - 824-300

Inlet Options	Part #
Reverse Interiors	Inlet # - 001

Main Options



Reverse Interiors



Flush Mount



Locking Pawl

See pgs 197-206 for detailed information on these options

PN12c Order Example:

To order a device with a reverse interior add **-001** to the inlet and receptacle part numbers.

PN12c Receptacle 5P+G 03-A4001-**001**

PN12c Inlet 5P+G 03-A8001-**001**

Appropriate accessory part numbers must also be included on the order.

Installation Accessories

Unless indicated otherwise, accessories can be used with either poly or metal plugs and receptacles

Handles



NPT	Poly Handle Threaded Opening	Metal Handle* Threaded Opening	90° Nylon Handle Threaded Opening
1/2"	01-NA013-12	H091U12	04-2A090-5-12
3/4"	01-NA013-34	H091U34	04-2A090-5-34
1"	01-NA013-1	H091U1	04-2A090-5-10

Cable Range	Nylon Handle w/Clamp & Bushing	Angled Nylon Handle w/Clamp & Bushing
.35 - .70	01-NA013	01-NA313

Notes: • For available cord grips, see pgs 193-194.
* For metal devices only

NPT Guidelines

Cable Range	NPT
.062 - .5	1/2"
.187 - .75	3/4"
.437 - 1.10	1"
.750 - 1.375	1 1/4"

NPT sizes are determined by the cable diameter and third party cord grip.

Junction Boxes



NPT	Metal Box	Metal Box Nylon Angle 30°	Metal Box Metal Angle 45°	Poly Conduit* Entry	Poly Straight* Wall Box	Metal Straight Wall Box	Poly 70°** Wall Box
1/2"	MB312	01-NA053-080-12	09-NA053-080-12	01-NA023-12	01-NA025-12	09-NA025-12	51-AA058
3/4"	MB334	01-NA053-080-34	09-NA053-080-34	01-NA023-34	01-NA025-34	09-NA025-34	51-AA058
1"	MB31	01-NA053-080-1	09-NA053-080-1	-	-	-	51-AA058
1 1/4"	MB3114	01-NA053-080-114	09-NA053-080-114	-	-	-	51-AA058

* For poly devices only
** 70° boxes are not drilled. Contact customer service if factory drilling is required.
* Interior volume with receptacle installed.

Angles

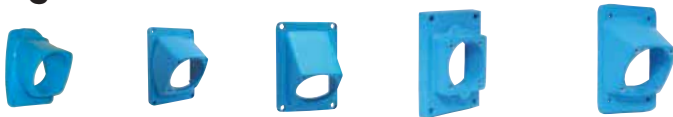

Nylon 30° Angle	Nylon 30° Angle for MB Box	Metal 45° Angle	Metal Straight Adapter	Metal 30° Angle/ Adapter Plate for FS Box
01-NA027	01-NA027-601	09-NA027	MSPN	MAFS1*

* Includes angle, adapter plate and gaskets for FS box mounting

Miscellaneous Accessories



Protective Cap	Flush Mount	Cord Grip with Mesh	Multi-Contact Removal Tool	Crimper Tool (Greenlee or equal)	European Crimping Tool
01-NA126	01-2A142	see pgs 193-194	9-LD12-37	4CN30	61-CA500

Order Example

A typical order should include an inlet part number, a receptacle part number **AND** the matching handles, angles or other required accessories.



Male Inlet with Handle (Plug)
07-A8001 + 01-NA313



Female Receptacle with Angle Adapter
07-A4001 + 01-NA027

PN12c



PN12c Multipin – 7.5A Stainless Steel Plugs & Receptacles

Receptacle (female)

Inlet (male)

Ratings

- **Voltage**
600 VAC Max/130 VDC
- **Amperage Rating**
5A Current Interrupting
7.5A Non-Current Interrupting
! PN12c is capable of handling
4-20mA low current applications
- **Temperature Range**
Min -40°F/Max 140°F
- **Wiring Capacity**
Min 18 AWG Max 14 AWG



Don't forget to add installation accessories to your order



For PN12c SS dimensions, contact Customer Service

Voltage	Polarity	Part # Stainless Steel
600V	11P+G	07-A4001-SS

Voltage	Polarity	Part # Stainless Steel
600V	11P+G	07-A8001-SS

NEW Feature

New Feature

- **Crimped Contacts**
PN12c devices now feature contacts that can be crimped or soldered. Each device is supplied with 13 contacts so that the product can be set up to suit application needs.

Simple Assembly and Disassembly

DSN37c shown



Assembly

To insert contacts when they have been wired is simple. Push wired contact into rear of insulator until it stops to complete the installation.



Disassembly

To remove, use the tool provided. Push tool from front onto contact until tool stops. Contact is then released at rear of insulator.

PN12c Stainless Steel Multipins are made of machined 304 Stainless Steel.



Installation Accessories

Handles



NPT	Stainless Steel Handle
1/2"	09-2A013-SS-12
3/4"	09-2A013-SS-34

Angles



Stainless Steel
30° Angle

09-2A027-SS

Junction Boxes



NPT	Stainless Steel Box with Stainless Steel Angle
3/4"	09-2A053-080-SS-34
1"	09-2A053-080-SS-1

Notes: • Includes angle adapter as shown.

Miscellaneous Accessories



Multi-Contact Removal Tool	Crimper Tool (Greenlee or equal)	European Crimping Tool
9-LD12-37	4CN30	61-CA500

NPT Guidelines

Cable Range	NPT
.312 - .625	1/2"
.438 - .812	3/4"
.660 - 1.000	1"
.875 - 1.375	1 1/4"
.890 - 1.812	1 1/2"
1.190 - 2.438	2"
2.062 - 2.438	2 1/2"

NPT sizes are determined by the cable diameter and third party cord grip.

Order Example

A typical order should include an inlet part number, a receptacle part number **AND** the matching handles, angles or other required accessories.



Male Inlet with Handle (Plug)
07-A8001-SS + 09-2A013-SS-34



Female Receptacle with Angle Adapter
07-A4001-SS + 09-2A027-SS

DSN24c



DSN24c Multipin – 7.5A Plugs & Receptacles

Ratings

- **Voltage**
50 VAC or 480 VAC Max/130 VDC*
* For DC order 480V model
 - **Amperage Rating**
2A Current Interrupting
7.5A Non-Current Interrupting
! DSN24c is capable of handling
4-20mA low current applications
 - **Environmental Ratings**
IP66+IP67
 - **Temperature Range**
Min -40°F/Max 140°F
See pg 220 for temps below -15°F.
 - **Wiring Capacity**
Min 18 AWG Max 14 AWG
 - **Listings**
CE*
- * Contact Customer Service

For DSN24c dimensions, see pgs 33-34

New Feature

- **Crimped Contacts**
DSN24c devices now feature contacts that can be crimped or soldered. Each device is supplied with 2 bags of 13 contacts so that the product can be set up to suit application needs.

Receptacle (female)



Don't forget to add installation accessories to your order

Inlet (male)



Voltage	Polarity	Part # Poly
50V	24P*	63-B4002
480V	23P+G*	63-B4002

Voltage	Polarity	Part # Poly
50V	13P*	63-B8002
480V	23P+G*	63-B8002

* 24P for devices up to 50V or 23P+G for devices up to 480V. Multiple voltage labels are provided for application in the field.

Simple Assembly and Disassembly

DSN37c shown



Assembly

To insert contacts when they have been wired is simple. Push wired contact into rear of insulator until it stops to complete the installation.



Disassembly

To remove, use the tool provided. Push tool from front onto contact until tool stops. Contact is then released at rear of insulator.

Main Options



Padlock Pawl



Mushroom Pawl



Self-Ejecting Devices*

* Requires straight insertion receptacle or inlet and self-ejecting plug or connector

Receptacle Options	Part #
Straight Insertion	Recept # - A188
Self-Ejecting Connector Release	Recept # - 345-A188
Mushroom Pawl	Recept # - 375
Padlock Pawl	Recept # - 843
Padlockable Mushroom Pawl	Recept # - 375- 843
Closed Lid Configuration	Recept # - NC



See pgs 197-206 for detailed information on these options

Inlet Options	Part #
Self-Ejecting Plug Release	Inlet # - 338-A188
Straight Insertion	Inlet # - A188

DSN24c Order Example:

To order a device with a Mushroom Pawl add **-375** to the receptacle part number

DSN24c 22P = 63-B4002-**375**

Installation Accessories

Handles



NPT	Poly Handle	Cable Range	Poly Handle w/Clamp & Bushing	Nylon Handle
1/2"	61-3A013-12	.20 - .83	-	61-3A013
3/4"	61-3A013-34	.750 - .875	1PM514	-
1"	61-3A013-1	.875 - 1.000	1PM516	-
1 1/4"	61-3A013-114	1.000 - 1.125	1PM518	-
		1.125 - 1.250	1PM520	-
		1.250 - 1.375	1PM522	-

- Notes:**
- Finger draw plates are recommended for easier connector closure on cord to cord assemblies.
 - For available cord grips see pgs 193-194.

NPT Guidelines

Cable Range	NPT
.312 - .625	1/2"
.438 - .812	3/4"
.660 - 1.000	1"
.875 - 1.375	1 1/4"

NPT sizes are determined by the cable diameter and third party cord grip.

Angles



Nylon 30° Angle	Metal 30° Angle	Metal Angle FS/FD Box 30°	Metal Straight Adapter
61-3A027	MA2	MAFS2	MS2

Junction Boxes



NPT	Metal Box	Metal Box with Nylon Angle	Poly* Conduit Entry	Poly 70°** Wall Box
1/2"	MB312	61-3A053-080-12	61-3A023-12	51-BA058
3/4"	MB334	61-3A053-080-34	61-3A023-34	51-BA058
1"	MB31	61-3A053-080-1	-	51-BA058
1 1/4"	MB3114	61-3A053-080-114	-	51-BA058

- * For poly devices only
 ** 70° boxes are not drilled. Contact customer service if factory drilling is required.
 * Interior volume with receptacle installed.

Miscellaneous Accessories



Finger Drawplates	Protective Cap	Padlockable Plug Cap	Cord Grip with Mesh	Multi-Contact Removal Tool	Crimper Tool (Greenlee or equal)	European Crimping Tool
61-3A346	61-3A126	61-3A826	see pgs 193-194	9-LD12-37	4CN30	61-CA500

* Recommended for cord to cord assembly applications, for easier connector closure

Order Example

A typical order should include an inlet part number, a receptacle part number **AND** the matching handles, angles or other required accessories.



Male Inlet with Handle (Plug)
63-B8002 + 61-3A013



Female Receptacle with Angle Adapter
63-B4002 + 61-3A027

DS24c



DS24c Multipin – 7.5A Stainless Steel Plugs & Receptacles

Ratings

- **Voltage**
Up to 250 VAC Max/130 VDC
- **Amperage Rating**
2A Current Interrupting
7.5A Non-Current Interrupting
! DS24c is capable of 4 20mA low current applications.
- **Temperature Range**
Min -40°F / Max 140°F
- **Wiring Capacity**
Min 18 AWG Max 14 AWG

For DS24c dimensions, see pgs 51-52

Receptacle (female)



Don't forget to add installation accessories to your order

Inlet (male)



Voltage	Polarity	Part # Stainless Steel
50V	24P+	37-B4002-SS
250V	23P+G+	37-B4002-SS

Voltage	Polarity	Part # Stainless Steel
50V	24P+	37-B8002-SS
250V	23P+G+	37-B8002-SS

+ 24P for devices up to 50V or 36P+G for devices up to 480V. Multiple voltage labels are provided for application in the field.



New Feature

- **Crimped Contacts**
DS24c devices now feature contacts that can be crimped or soldered. Each device is supplied with 2 bags of 13 contacts so that the product can be set up to suit application needs.

Simple Assembly and Disassembly

DSN37c shown



Assembly

To insert contacts when they have been wired is simple. Push wired contact into rear of insulator until it stops to complete the installation.



Disassembly

To remove, use the tool provided. Push tool from front onto contact until tool stops. Contact is then released at rear of insulator.

Installation Accessories

Handles



NPT	Stainless Steel Handle
3/4"	1H34SS
1"	1H1SS

Angles



Stainless Steel 30° Angle
MA2SS

Junction Boxes

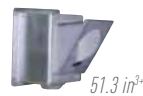

NPT	Stainless Steel Box with* Stainless Steel Angle	Stainless Steel Box
1	39-1A053-080-SS-1	MB31SS

Notes: * Includes angle adapter as shown.
 * Interior volume with receptacle installed.

Miscellaneous Accessories



Multi-Contact Removal Tool	Crimper Tool (Greenlee or equal)	European Crimping Tool
9-LD12-37	4CN30	61-CA500

NPT Guidelines

Cable Range	NPT
.312 - .625	1/2"
.438 - .75	3/4"
.660 - 1.000	1"
.975 - 1.375	1 1/4"
.890 - 1.812	1 1/2"
1.190 - 2.438	2"
2.062 - 2.438	2 1/2"

NPT sizes are determined by the cable diameter and third party cord grip.

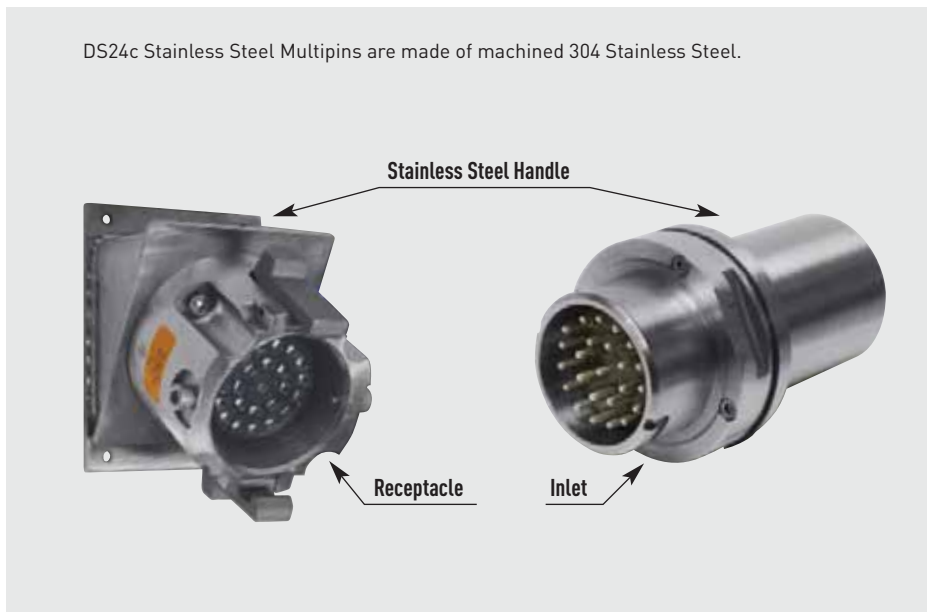

DS24c Stainless Steel Multipins are made of machined 304 Stainless Steel.

Order Example

A typical order should include an inlet part number, a receptacle part number **AND** the matching handles, angles or other required accessories.



Male Inlet with Handle (Plug)
 37-B8002-SS + 1H1SS



Female Receptacle with Angle Adapter
 37-B4002-SS + MA2SS

DSN37c



DSN37c Multipin – 7.5A Plugs & Receptacles

Ratings

- **Voltage**
Up to 480 VAC Max/130 VDC
- **Amperage Rating**
2A Current Interrupting
7.5A Non-Current Interrupting
! DSN37c is capable of handling
4-20mA low current applications
- **Environmental Ratings**
IP66+IP67
- **Temperature Range**
Min -40°F/Max 140°F
See pg 220 for temps below -15°F.
- **Wiring Capacity**
Min 18 AWG Max 14 AWG
- **Listings**
CE*
* Contact Customer Service

Receptacle (female)



Don't forget to add installation accessories to your order

Inlet (male)



Voltage	Polarity	Part # Poly
50V	37P+	63-C4003
480V	36P+G+	63-C4003

Voltage	Polarity	Part # Poly
50V	37P+	63-C8003
480V	36P+G+	63-C8003

+ 37P for devices up to 50V or 36P+G for devices up to 480V. Multiple voltage labels are provided for application in the field.

For DSN37c dimensions, see pgs 33-34

NEW Feature

New Feature

- **Crimped Contacts**
DSN37c devices now feature contacts that can be crimped or soldered. Each device is supplied with 3 bags of 13 contacts so that the product can be set up to suit application needs.

Simple Assembly and Disassembly



Assembly

To insert contacts when they have been wired is simple. Push wired contact into rear of insulator until it stops to complete the installation.



Disassembly

To remove, use the tool provided. Push tool from front onto contact until tool stops. Contact is then released at rear of insulator.

Main Options



Padlock Pawl



Mushroom Pawl



Self-Ejecting Devices*

* Requires straight insertion receptacle or inlet and self-ejecting plug or connector

Receptacle Options	Part #
Straight Insertion	Recept # - A188
Self-Ejecting Connector Release	Recept # - 345-A188
Mushroom Pawl	Recept # - 375
Padlock Pawl	Recept # - 843
Padlockable Mushroom Pawl	Recept # - 375- 843
Closed Lid Configuration	Recept # - NC



See pgs 197-206 for detailed information on these options

Inlet Options	Part #
Self-Ejecting Plug Release	Inlet # - 338-A188
Straight Insertion	Inlet # - A188

DSN37c Order Example:

To order a device with a Mushroom Pawl add **-375** to the receptacle part number

DSN37c 32P = 63-C4003-375

Installation Accessories

Handles



Makes connector closures easier

NPT	Poly Handle	Cable Range	Poly Handle w/Clamp & Bushing	Nylon Handle	Poly Handle w/built in Draw Grips
1/2"	61-6A013-12	.32 - 1.25	-	-	61-6A473
3/4"	61-6A013-34	.39 - 1.18	-	61-6A013	-
1"	61-6A013-1	.750 - .875	3PM514	-	-
1 1/4"	61-6A013-114	.875 - 1.000	3PM516	-	-
		1.000 - 1.125	3PM518	-	-
		1.125 - 1.250	3PM520	-	-
		1.250 - 1.375	3PM522	-	-

NPT Guidelines

Cable Range	NPT
.312 - .625	1/2"
.438 - .812	3/4"
.660 - 1.000	1"
.875 - 1.375	1 1/4"

NPT sizes are determined by the cable diameter and third party cord grip.

- Notes:**
- Finger draw plates are recommended for easier connector closure on cord to cord assemblies.
 - For available cord grips see pgs 193-194.

Angles



Nylon 30° Angle	Metal 30° Angle	Metal 70° Angle	Metal Angle FS/FD Box 30°	Metal Straight Adapter
61-6A027	MA3	89-3A027	MAFS3	MS3

Junction Boxes



32.5 in³*



16.4 in³*



188.6 in³*

NPT	Metal Box	Metal Box with Nylon Angle	Poly* Conduit Entry	Poly 70°** Wall Box
1/2"	MB312	61-6A053-080-12	61-6A023-12	51-CA058
3/4"	MB334	61-6A053-080-34	61-6A023-34	51-CA058
1"	MB31	61-6A053-080-1	61-6A023-1	51-CA058
1 1/4"	MB3114	61-6A053-080-114	-	51-CA058

- * For poly devices only
 ** 70° boxes are not drilled. Contact customer service if factory drilling is required.
 * Interior volume with receptacle installed.

Miscellaneous Accessories



* Set of Two (2)



For Male Devices Only



For Male Devices Only



Finger Drawplates	Protective Cap	Padlockable Plug Cap	Cord Grip with Mesh	Multi-Contact Removal Tool	Crimper Tool (Greenlee or equal)	European Crimping Tool
61-6A346	61-6A126	61-6A826	see pgs 193-194	9-LD12-37	4CN30	61-CA500

* Recommended for cord to cord assembly applications, for easier connector closure

Order Example

A typical order should include an inlet part number, a receptacle part number **AND** the matching handles, angles or other required accessories.



Male Inlet with Handle (Plug)
63-C8003 + 61-6A013



Female Receptacle with Angle Adapter
63-C4003 + 61-6A027

DS37c



DS37c Multipin – 7.5A

Stainless Steel Plugs & Receptacles

Receptacle (female)

Inlet (male)



Don't forget to add installation accessories to your order

Ratings

- **Voltage**
Up to 480 VAC Max*/130 VDC
- **Amperage Rating**
2A Current Interrupting
7.5A Non-Current Interrupting
! DS37c is capable of 4 - 20mA low current applications.
- **Temperature Range**
Min -40°F/Max 140°F
- **Wiring Capacity**
Min 18 AWG Max 14 AWG

For DS37c dimensions, see pgs 51-52

Voltage	Polarity	Part # Stainless Steel
50V	37P ⁺	37-C4003-SS
480V	36P+G ⁺	37-C4003-SS

Voltage	Polarity	Part # Stainless Steel
50V	37P ⁺	37-C8003-SS
480V	36P+G ⁺	37-C8003-SS

* 37P for devices up to 50V or 36P+G for devices up to 480V. Multiple voltage labels are provided for application in the field.

NEW Feature

New Feature

- **Crimped Contacts**
DS37c devices now feature contacts that can be crimped or soldered. Each device is supplied with 3 bags of 13 contacts so that the product can be set up to suit application needs.

Simple Assembly and Disassembly

DSN37c shown



Assembly

To insert contacts when they have been wired is simple. Push wired contact into rear of insulator until it stops to complete the installation.



Disassembly

To remove, use the tool provided. Push tool from front onto contact until tool stops. Contact is then released at rear of insulator.

Installation Accessories

Handles



NPT	Stainless Steel Handle
3/4"	3H34SS
1"	3H1SS
1 1/4"	3H114SS

NPT Guidelines

Cable Range	NPT
.438 - .812	3/4"
.660 - 1.000	1"
.875 - 1.375	1 1/4"

NPT sizes are determined by the cable diameter and third party cord grip.

Angles



Stainless Steel 30° Angle
MA3SS

Junction Boxes

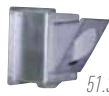

51.3 in³*



NPT	Stainless Steel Box with* Stainless Steel Angle	Stainless Steel Box
1	39-3A053-080-SS-1	MB31SS

Notes: * Includes angle adapter as shown.
* Interior volume with receptacle installed.

Miscellaneous Accessories



Multi-Contact Removal Tool	Crimper Tool (Greenlee or equal)	European Crimping Tool
9-LD12-37	4CN30	61-CA500

DS37c Stainless Steel Multipins are made of cast stainless steel.

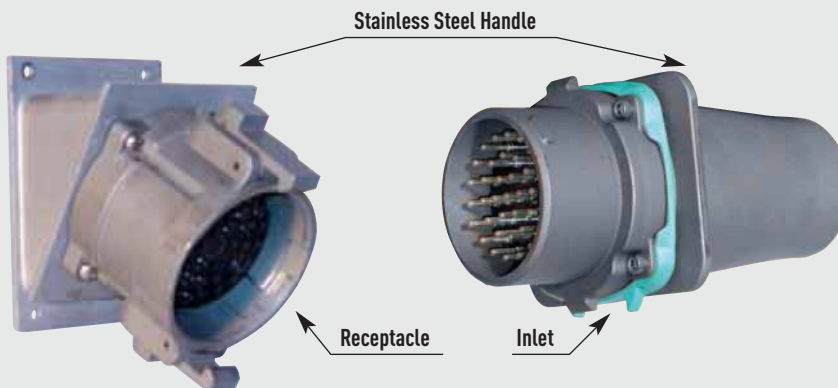

Order Example

A typical order should include an inlet part number, a receptacle part number **AND** the matching handles, angles or other required accessories.



Male Inlet with Handle (Plug)
37-C8003-SS + 3H1SS



Female Receptacle with Angle Adapter
37-C4003-SS + MA3SS

PN7c



PN7c Multipin – 20A

Poly/Stainless Steel Plugs & Receptacles

Ratings

- **Voltage**
600 VAC Max/130 VDC*
- **Amperage Rating**
15A Current Interrupting
20A Non-Current Interrupting
- **Environmental Ratings**
IP66+IP67*
- **Temperature Range**
Min -40°F/Max 140°F
See pg 220 for temps below -15°F.
- **Wiring Capacity**
Min 18 AWG Max 10 AWG
- **Listings**
UL*, CSA*, CE*
* Contact Customer Service
+ Poly/metal versions only

For PN7c dimensions, see pgs 165-166

Receptacle (female)



Don't forget to add installation accessories to your order

Voltage	Polarity	Part #		
		Poly	Metal	Stainless Steel
600V	4P+G	01-P4041	09-P4041	09-04041-SS
600V	5P+G	01-P4051	09-P4051	09-04051-SS
600V	6P+G	01-P4061	09-P4061	09-04061-SS

Inlet (male)



Voltage	Polarity	Part #		
		Poly	Metal	Stainless Steel
600V	4P+G	01-P8041	09-P8041	09-08041-SS
600V	5P+G	01-P8051	09-P8051	09-08051-SS
600V	6P+G	01-P8061	09-P8061	09-08061-SS

Main Options



Reverse Interiors



Flush Mount



Locking Pawl



See pgs 197-206 for detailed information on these options

Receptacle Options

Part

Reverse Interiors	Recept # - 001
With Flush Mount (poly only)	Recept # - 142
Locking Pawl	Recept # - 824-300

Inlet Options

Part

Reverse Interiors	Inlet # - 001
-------------------	---------------

PN7c Order Example:

To order a device with a reverse interior add **-001** to the inlet and receptacle part numbers.

PN7c Receptacle 5P+G 01-P4051-**001**

PN7c Inlet 5P+G 01-P8051-**001**

Appropriate accessory part numbers must also be included on the order.

Installation Accessories

Accessories can be used with either poly or metal plugs and receptacles, except stainless steel accessories should only be used with stainless inlets and receptacles.

Handles



NPT	Poly Handle Threaded Opening	Metal Handle* Threaded Opening	90° Nylon Handle Threaded Opening	Stainless Steel Handle
1/2"	01-NA013-12	H091U12	04-2A090-5-12	-
3/4"	01-NA013-34	H091U34	04-2A090-5-34	09-2A013-SS-34
1"	01-NA013-1	H091U1	04-2A090-5-10	

Cable Range	Nylon Handle w/Clamp & Bushing	Angled Nylon Handle w/Clamp & Bushing
.35 - .69	01-NA013	01-NA313

Notes: • For available cord grips, see pgs 193-194.
* For metal devices only

NPT Guidelines

Cable Range	NPT
.312 - .625	1/2"
.438 - .812	3/4"
.660 - 1.000	1"
.875 - 1.375	1 1/4"

NPT sizes are determined by the cable diameter and third party cord grip.

Junction Boxes



NPT	Metal Box	Metal Box with Nylon 30° Angle	Metal Box with Metal 45° Angle	Poly Conduit* Entry	Poly Straight* Wall Box	Metal Straight Wall Box	Stainless Steel Angle with Stainless Steel Box	Poly 70°** Wall Box
1/2"	MB312	01-NA053-080-12	09-NA053-080-12	01-NA023-12	01-NA025-12	09-NA025-12	-	51-AA058
3/4"	MB334	01-NA053-080-34	09-NA053-080-34	01-NA023-34	01-NA025-34	09-NA025-34	-	51-AA058
1"	MB31	01-NA053-080-1	09-NA053-080-1	-	-	-	09-2A053-080-SS-1	51-AA058
1 1/4"	MB3114	01-NA053-080-114	09-NA053-080-114	-	-	-	-	51-AA058

* For poly devices only
** 70° boxes are not drilled. Contact customer service if factory drilling is required.
* Interior volume with receptacle installed.

Angles

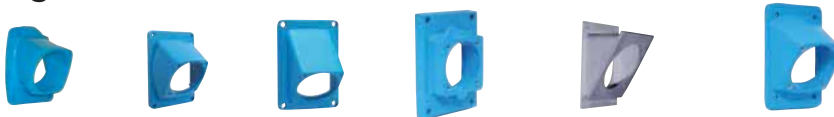

Nylon 30° Angle	Nylon 30° Angle for MB Box	Metal 45° Angle	Metal Straight Adapter	Stainless Steel 30° Angle	Metal 30° Angle/Adapter Plate for FS Box
01-NA027	01-NA027-601	09-NA027	MSPN	09-2A027-SS	MAFS1*

* Includes angle, adapter plate and gaskets for FS box mounting

Miscellaneous Accessories



Protective Cap	Flush Mount	Cord Grip with Mesh
01-NA126	01-2A142	see pgs 193-194

Order Example

A typical order should include an inlet part number, a receptacle part number **AND** the matching handles, angles or other required accessories.



Male Inlet with Handle (Plug)
09-P8061 + 01-NA313



Female Receptacle with Angle Adapter
09-P4061 + 01-NA027

DN9c



DN9c Multipin – 20A Plugs & Receptacles

Ratings

- Voltage**
50 VAC or 480 VAC Max/130 VDC+
+For DC order 480V model. Not CSA listed.
- Amperage Rating**
20A Current Interrupting
- Horsepower Ratings**

120V	1Ø	1/3 hp
240V	1Ø	1 hp
208V	3Ø	2 hp
240V	3Ø	3 hp
480V	3Ø	5 hp
- Environmental Ratings**
IP54/IP55
- Temperature Range**
Min -40°F/Max 140°F
See pg 220 for temps below -15°F.
- Wiring Capacity**
Min 16 AWG Max 10 AWG
- Listings**
CSA, CE*
* Contact Customer Service for CE rated devices.

Receptacle (female)



Don't forget to add installation accessories to your order

Inlet (male)



Voltage	Polarity	Part # Metal
50V	6P	17-14060
50V	7P	17-14070
50V	8P	17-14080
50V	9P	17-14090
480V	5P+G	17-14051
480V	6P+G	17-14061
480V	7P+G	17-14071
480V	8P+G	17-14081

Voltage	Polarity	Part # Metal
50V	6P	17-18060
50V	7P	17-18070
50V	8P	17-18080
50V	9P	17-18090
480V	5P+G	17-18051
480V	6P+G	17-18061
480V	7P+G	17-18071
480V	8P+G	17-18081

Main Options



Mushroom Pawl



Padlock Pawl



Self-Ejecting Devices

* Requires straight insertion receptacle or inlet and self-ejecting plug or connector

Receptacle Options

Part

Straight Insertion	Recept # - A188
Self-Ejecting Connector Release	Recept # - 348-A188
HP Watertightness (high pressure)	Recept # - HP
Mushroom Pawl	Recept # - 375
Locking Mushroom Pawl	Recept # - 845
Padlock Pawl	Recept # - 843
Padlockable Mushroom Pawl	Recept # - 375- 843
Closed Lid Configuration	Recept # - NC

Inlet Options

Part

Self-Ejecting Plug Release	Inlet # - 338-A188
Straight Insertion	Inlet # - A188



See pgs 197-206 for detailed information on these options

DN9c Order Example:

To order Closed Lid Configuration on a receptacle add **-NC** to the part numbers.

DN9c Receptacle 9P=17-14090-NC

Appropriate accessory part numbers must also be included on the order.

Installation Accessories

Handles



Not NEMA 3R

Makes connector closures easier

NPT	Poly Handle	Metal Handle
1/2"	3PH12	3H12
3/4"	3PH34	3H34
1"	3PH1	3H1
1 1/4"	3PH114	3H114

Cable Range	Nylon Handle	Neoprene Handle	Poly Handle w/Clamp & Bushing	Poly Handle w/built in Draw Grips
.32 - 1.25	-	-	-	FH311-473
.38 - 1.12	-	31-311	-	-
.39 - 1.18	FH311	-	-	-
.750 - .875	-	-	3PM514	-
.875 - 1.000	-	-	3PM516	-
1.000 - 1.125	-	-	3PM518	-
1.125 - 1.250	-	-	3PM520	-
1.250 - 1.375	-	-	3PM522	-

- Notes:**
- Finger draw plates are recommended for easier connector closure on cord to cord assemblies.
 - For available cord grips, see pgs 193-194.

Angles



Metal 30° Angle	Metal 70° Angle	Metal Angle FS/FD Box 30°	Metal Straight Adapter
MA3	89-3A027	MAFS3	MS3

NPT Guidelines

Cable Range	NPT
.312 - .625	1/2"
.438 - .812	3/4"
.660 - 1.000	1"
.875 - 1.375	1 1/4"

NPT sizes are determined by the cable diameter and third party cord grip.

Junction Boxes

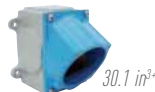

30.1 in³*

NPT	Metal Box	Metal Box Metal Angle 30°
1/2"	MB312	39-3A053-080-12
3/4"	MB334	39-3A053-080-34
1"	MB31	39-3A053-080-1
1 1/4"	MB3114	39-3A053-080-114

* Interior volume with receptacle installed.

Miscellaneous Accessories



* Set of Two (2)



For Male Devices Only



Finger Drawplates	Protective Neoprene Cap	Cord Grip with Mesh
FDP3	DN16R	see pgs 193-194

* Recommended for cord to cord assembly applications, for easier connector closure

Order Example

A typical order should include an inlet part number, a receptacle part number **AND** the matching handles, angles or other required accessories.



Male Inlet with Handle (Plug)
17-18060 + FH311



Female Receptacle with Angle Adapter
17-14060 + MA3

DN20c



DN20c Multipin – 20A

Plugs & Receptacles

Ratings

- Voltage**
 50 VAC or 480 VAC Max / 130 VDC+
 +For DC order 480V model. Not CSA listed.
- Amperage Rating**
 20A / 15A Current Interrupting*
 * The amperage rating is 15A when more than 12 contacts are used for power circuits (not control).
- Horsepower Ratings**

120V	1Ø	1/6 hp
240V	1Ø	1/2 hp
208V	3Ø	1 hp
240V	3Ø	1 hp
480V	3Ø	3 hp
- Environmental Ratings**
 IP54 / IP55
- Temperature Range**
 Min -40°F / Max 140°F
 See pg 220 for temps below -15°F.
- Wiring Capacity**
 Min 16 AWG Max 10 AWG
- Listings**
 CSA, CE**
 ** Contact Customer Service for CE rated devices.

Receptacle (female)



Don't forget to add installation accessories to your order

Inlet (male)



* The amperage rating is 15A when more than 12 contacts are used for power circuits (not control).

Voltage	Polarity	Part # Metal
50V	10P	17-64100
50V	11P	17-64110
50V	12P	17-64120
50V	13P	17-64130*
50V	14P	17-64140*
50V	15P	17-64150*
50V	16P	17-64160*
50V	17P	17-64170*
50V	18P	17-64180*
50V	19P	17-64190*
50V	20P	17-64200*
480V	9P+G	17-64091
480V	10P+G	17-64101
480V	11P+G	17-64111
480V	12P+G	17-64121
480V	13P+G	17-64131*
480V	14P+G	17-64141*
480V	15P+G	17-64151*
480V	16P+G	17-64161*
480V	17P+G	17-64171*
480V	18P+G	17-64181*
480V	19P+G	17-64191*

Voltage	Polarity	Part # Metal
50V	10P	17-68100
50V	11P	17-68110
50V	12P	17-68120
50V	13P	17-68130*
50V	14P	17-68140*
50V	15P	17-68150*
50V	16P	17-68160*
50V	17P	17-68170*
50V	18P	17-68180*
50V	19P	17-68190*
50V	20P	17-68200*
480V	9P+G	17-68091
480V	10P+G	17-68101
480V	11P+G	17-68111
480V	12P+G	17-68121
480V	13P+G	17-68131*
480V	14P+G	17-68141*
480V	15P+G	17-68151*
480V	16P+G	17-68161*
480V	17P+G	17-68171*
480V	18P+G	17-68181*
480V	19P+G	17-68191*

Main Options



Mushroom Pawl



Self-Ejecting Devices

* Requires straight insertion receptacle or inlet and self-ejecting plug or connector



See pgs 197-206 for detailed information on these options

Receptacle Options

Part

Straight Insertion	Recept # - A188
Self-Ejecting Connector Release	Recept # - 348-A188
HP Watertightness (high pressure)	Recept # - HP
Mushroom Pawl	Recept # - 375
Locking Mushroom Pawl	Recept # - 845
Padlock Pawl	Recept # - 843
Padlockable Mushroom Pawl	Recept # - 375-843
180° Opening Lid	Recept # - 180
Closed Lid Configuration	Recept # - NC

Inlet Options

Part

Self-Ejecting Plug Release	Inlet # - 338-A188
Straight Insertion	Inlet # - A188

DN20c Order Example:

To order Closed Lid Configuration on a receptacle add **-NC** to the receptacle part numbers.

DN20c Receptacle 19P=17-64190-NC

Appropriate accessory part numbers must also be included on the order.

Installation Accessories

Handles



NPT	Poly Handle	Metal Handle	Cable Range	Santoprene™ Handle	Poly Handle w/Clamp & Bushing
3/4"	9PH34	9H34	.70 - 1.00	65-9A013-D25	-
1"	9PH1	9H1	1.00 - 1.375	65-9A013-D35	-
1 1/4"	9PH114	9H114	1.250 - 1.375	-	9PM622
1 1/2"	9PH112	9H112	1.375 - 1.750	65-9A013-D45	-
2"	9PH2	9H2	1.438 - 1.562	-	9PM625
			1.562 - 1.688	-	9PM627
			1.688 - 1.812	-	9PM629

Notes: • For available cord grips, see pgs 193-194.

Angles

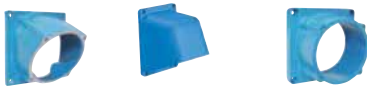

Metal 30° Angle	Metal 70° Angle	Metal Straight Adapter
MA10	89-9A027	MS10

Junction Boxes

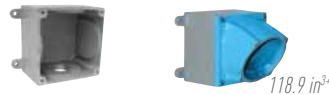

NPT	Metal Box	Metal Box Metal Angle 30°
1 1/4"	MB10114	39-9A053-080-114
1 1/2"	MB10112	39-9A053-080-112
2"	MB102	39-9A053-080-2
2 1/2"	MB10212	39-9A053-080-212

* Interior volume with receptacle installed.

NPT Guidelines

Cable Range	NPT
.312 - .625	1/2"
.438 - .812	3/4"
.660 - 1.000	1"
.875 - 1.375	1 1/4"
.890 - 1.812	1 1/2"
1.190 - 2.438	2"
2.062 - 2.438	2 1/2"

NPT sizes are determined by the cable diameter and third party cord grip.

Miscellaneous Accessories



For Male Devices Only

Protective Neoprene Cap

DN63R

Order Example

A typical order should include an inlet part number, a receptacle part number **AND** the matching handles, angles or other required accessories.



Male Inlet with Handle (Plug)
17-68200 + 65-9A013-D25



Female Receptacle with Angle Adapter
17-64200 + MA10

DN7c



DN7c Multipin – 50-150A Plugs & Receptacles

Ratings

- **Voltage**
480 VAC Max/130 VDC
- **Amperage Rating**
50A Non-Current Interrupting
90A Non-Current Interrupting
150A Non-Current Interrupting
- **Environmental Ratings**
IP54/IP55
- **Temperature Range**
Min -40°F / Max 140°F
See pg 220 for temps below -15°F.
- **Wiring Capacity**
50A Min 14 AWG Max 6 AWG
90A Min 8 AWG Max 2 AWG
150A Min 4 AWG max 2/0 AWG
- **Listings**
Contact Customer Service

Receptacle (female)



Don't forget to add installation accessories to your order

Inlet (male)



Voltage	Polarity	Amperage	Part # Metal
480V	6P+G	50A	19-34061
480V	6P+G	90A	19-64061
480V	6P+G	150A	39-94061

Voltage	Polarity	Amperage	Part # Metal
480V	6P+G	50A	19-38061
480V	6P+G	90A	19-68061
480V	6P+G	150A	39-98061

Installation Accessories

Order Example

A typical order should include an inlet part number, a receptacle part number **AND** the matching handles, angles or other required accessories.



Male Inlet with Handle (Plug)
19-38061 + 6PH34



Female Receptacle with Angle Adapter
19-34061 + MA6

Handles



NPT	Poly Handle			Metal Handle		
	50A	90A	150A	50A	90A	150A
1/2"	6PH12	-	-	6H12	-	-
3/4"	6PH34	9PH34	-	6H34	19-6A013-34	-
1"	6PH1	9PH1	-	6H1	19-6A013-1	2H1
1 1/4"	6PH114	9PH114	-	6H114	19-6A013-114	2H114
1 1/2"	6PH112	9PH112	2PH112	6H112	19-6A013-112	2H112
2"	-	9PH2	2PH2	-	19-6A013-2	2H2
2 1/2"	-	-	2PH212	-	-	2H212

Installation Accessories

Handles



Not NEMA 3R

IP 66/67

IP 66/67

Cable Range	Nylon Handle 50A	Neoprene Handle	Santoprene™ Handle 90A	Santoprene™ Handle 150A	Poly Handle w/Clamp & Bushing	
					50A	90A
.50 - 1.25	-	31-611 (50A)	-	-	-	-
.51 - 1.38	FH611	-	-	-	-	-
.70 - 1.00	-	-	65-9A013-D25	-	-	-
1.00 - 1.375	-	-	65-9A013-D35	35-2A013-D35	-	-
1.250 - 1.375	-	-	-	-	6PM622	9PM622
1.375 - 1.750	-	-	65-9A013-D45	35-2A013-D45	-	-
1.438 - 1.562	-	-	-	-	6PM625	9PM625
1.562 - 1.688	-	-	-	-	6PM627	9PM627
1.688 - 1.812	-	-	-	-	6PM629	9PM629
1.750 - 1.900	-	-	-	35-2A013-D49	-	-

Notes: • Finger draw plates are recommended for easier connector closure on cord to cord assemblies.
• For available cord grips, see pgs 193-194.

• For a guideline of NPT sizes based on cable ranges, see DN20c pg 116.

Angles



MA10 shown

Amp	Metal 30° Angle	Metal 70° Angle	Metal Angle+ Oversized 30°	Metal Angle+ Oversized 45°	Metal Straight Adapter	Metal Lateral Angle 30°
50A	MA6	89-6A027	MA660	-	MS6	MAB6
90A	MA10	89-9A027	MA110	-	MS10	-
150A	MA20	-	-	MA220	MS20	-

* Mounts on oversize box only. Use next size up.

Junction Boxes

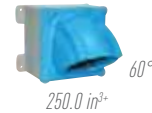
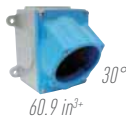

60.9 in³

114.5 in³

250.0 in³

NPT	Metal Box			Metal Box with Metal Angle		
	50A	90A	150A	50A	90A	150A
1"	MB61	-	-	39-6A053-080-1	-	-
1 1/4"	MB6114	MB10114	-	39-6A053-080-114	39-9A053-080-114	-
1 1/2"	MB6112	MB10112	MB20112	39-6A053-080-112	39-9A053-080-112	39-2A053-080-112
2"	MB62	MB102	MB202	39-6A053-080-2	39-9A053-080-2	39-2A053-080-2
2 1/2"	-	MB10212	MB20212	-	39-9A053-080-212	39-2A053-080-212
Oversized	-	-	MB22212	-	-	39-2A053-080-2210

* Interior volume with receptacle installed.

Miscellaneous Accessories



* Set of Two (2) For Male Devices Only

Amp	Finger Drawplates	Protective Neoprene Cap
50A	FDP6	-
90A	-	DN63R
150A	-	31-2A126

* Recommended for cord to cord assembly applications, for easier connector closure

DS7



DS7c Multipin – 30A Plugs & Receptacles

Ratings

- **Voltage**
50 VAC or 600 VAC Max/130 VDC+
+For DC order 600V model
- **Amperage Rating**
30A Current Interrupting
- **Environmental Ratings**
IP54/IP55
- **Temperature Range**
Min -40°F/Max 140°F
See pg 220 for temps below -15°F.
- **Wiring Capacity**
Min 14 AWG Max 8 AWG
- **Listings**
Contact Customer Service

For DS7c dimensions, see pgs 51-52

Receptacle (female)



Don't forget to add installation accessories to your order

Inlet (male)



Voltage	Polarity	Part #	
		Poly	Metal
50V	4P	33-34540	37-34540
50V	5P	33-34550	37-34550
50V	6P	33-34560	37-34560
50V	7P	33-34570	37-34570
600V	3P+G	33-34531	37-34531
600V	4P+G	33-34541	37-34541
600V	5P+G	33-34551	37-34551
600V	6P+G	33-34561	37-34561

Voltage	Polarity	Part #	
		Poly	Metal
50V	4P	33-38540	37-38540
50V	5P	33-38550	37-38550
50V	6P	33-38560	37-38560
50V	7P	33-38570	37-38570
600V	3P+G	33-38531	37-38531
600V	4P+G	33-38541	37-38541
600V	5P+G	33-38551	37-38551
600V	6P+G	33-38561	37-38561

Main Options



Padlock Pawl



Mushroom Pawl



Self-Ejecting Devices

* Requires straight insertion receptacle or inlet and self-ejecting plug or connector

Receptacle Options	Part #
With 2 Auxiliary/Pilot contacts	Recept # - 172
With 3 Auxiliary/Pilot contacts	Recept # - 173
NEMA 4X & closed lid configuration	Recept # - 4X
Straight Insertion	Recept # - A188
Self-Ejecting Connector Release	Recept # - 348-A188
Mushroom Pawl	Recept # - 375
Locking Mushroom Pawl	Recept # - 845
Padlock Pawl	Recept # - 843
Padlockable Mushroom Pawl	Recept # - 375- 843
Metal Pawl (on poly receptacle)	Recept # - 824
Closed Lid Configuration	Recept # - NC

Inlet Options	Part #
With 2 Auxiliary/Pilot Contacts	Inlet # - 172
With 3 Auxiliary/Pilot Contacts	Inlet # - 173
NEMA 4X Watertightness	Inlet # - 4X
Self-Ejecting Plug Release	Inlet # - 338-A188
Straight Insertion	Inlet # - A188
With No Lockout Hole	Inlet # - A155

DS7c Order Example:

To order a device with a Mushroom Pawl add **-375** to the receptacle part number
DS7c 4P = 33-34540-375

See pgs 197-206 for detailed information on these options

Installation Accessories

Unless indicated otherwise, accessories can be used with either poly or metal plugs and receptacles

Handles



NPT	Poly Handle	Metal* Handle	Cable Range	Nylon Handle	Neoprene Handle	Poly Handle w/Clamp & Bushing	Poly Handle w/built in Draw Grips
1/2"	6PH12	6H12	.50 - 1.25	-	31-611	-	-
3/4"	6PH34	6H34	.51 - 1.38	FH611	-	-	FH611-473
1"	6PH1	6H1	1.250 - 1.375	-	-	6PM622	-
1 1/4"	6PH114	6H114	1.438 - 1.562	-	-	6PM625	-
1 1/2"	6PH112	6H112	1.562 - 1.688	-	-	6PM627	-
			1.688 - 1.812	-	-	6PM629	-

- Notes:**
- Finger draw plates are recommended for easier connector closure on cord to cord assemblies.
 - For available cord grips, see pgs 193-194.
 - * For metal devices only

Angles



Nylon 30° Angle	Metal 30° Angle	Metal 70° Angle	Metal Angle+ Oversized 30°	Metal Straight Adapter	Metal Lateral Angle 30°
MP6	MA6	89-6A027	MA660	MS6	MAB6

* Mounts on oversize box only. Order with MB10 box. See page 46.

Junction Boxes

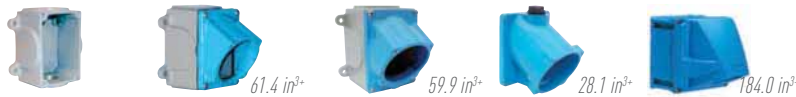

NPT	Metal Box	Metal Box with Nylon Angle	Metal Box with Metal Angle	Poly* Conduit Entry	Poly 70°** Wall Box
1/2"	-	-	-	MC612	51-DA058
3/4"	-	-	-	MC634	51-DA058
1"	MB61	31-6A053-080-1	39-6A053-080-1	MC61	51-DA058
1 1/4"	MB6114	31-6A053-080-114	39-6A053-080-114	MC6114	51-DA058
1 1/2"	MB6112	31-6A053-080-112	39-6A053-080-112	-	51-DA058
2"	MB62	31-6A053-080-2	39-6A053-080-2	-	51-DA058

- * For poly devices only ** 70° boxes are not drilled. Contact customer service if factory drilling is required.
 * Interior volume with receptacle installed.

Miscellaneous Accessories



* Set of Two (2) For Male Devices Only For Male Devices Only

Finger Drawplates	Protective Cap	Padlockable Cap Aluminum	Inlet Spring-Loaded cap
FDP6	31-6A126	DS6MC	31-6A226

* Recommended for cord to cord assembly applications, for easier connector closure

NPT Guidelines

Cable Range	NPT
.312 - .625	1/2"
.438 - .812	3/4"
.660 - 1.000	1"
.875 - 1.375	1 1/4"
.890 - 1.812	1 1/2"
1.190 - 2.438	2"
2.062 - 2.438	2 1/2"

NPT sizes are determined by the cable diameter and third party cord grip.

Order Example

A typical order should include an inlet part number, a receptacle part number **AND** the matching handles, angles or other required accessories.



Male Inlet with Handle (Plug)
33-38540 + FH611



Female Receptacle with Angle Adapter
33-34540 + MP6

DR7



DR7c Multipin – 50A Plugs & Receptacles

Ratings

- Voltage**
50 VAC or 600 VAC Max/130 VDC+
+For DC order 600V model
- Amperage Rating**
50A Non-Current Interrupting
- Environmental Ratings**
IP54/IP55
- Temperature Range**
Min -40°F/Max 140°F
See pg 220 for temps below -15°F.
- Wiring Capacity**
Min 14 AWG Max 8 AWG
- Listings**
Contact Customer Service

For DR7c dimensions, see pgs 155-156

Receptacle (female)



Don't forget to add installation accessories to your order

Inlet (male)



Voltage	Polarity	Part #	
		Poly	Metal
50V	4P	31-34940	39-34940
50V	5P	31-34950	39-34950
50V	6P	31-34960	39-34960
50V	7P	31-34970	39-34970
600V	3P+G	31-34931	39-34931
600V	4P+G	31-34941	39-34941
600V	5P+G	31-34951	39-34951
600V	6P+G	31-34961	39-34961

Voltage	Polarity	Part #	
		Poly	Metal
50V	4P	31-38940	39-38940
50V	5P	31-38950	39-38950
50V	6P	31-38960	39-38960
50V	7P	31-38970	39-38970
600V	3P+G	31-38931	39-38931
600V	4P+G	31-38941	39-38941
600V	5P+G	31-38951	39-38951
600V	6P+G	31-38961	39-38961

Main Options



Padlock Pawl



Mushroom Pawl



Self-Ejecting Devices

* Requires straight insertion receptacle or inlet and self-ejecting plug or connector

Receptacle Options

Part

With 2 Auxiliary/Pilot contacts	Recept # - 172
With 3 Auxiliary/Pilot contacts	Recept # - 173
NEMA 4X & closed lid configuration	Recept # - 4X
Straight Insertion	Recept # - A188
Self-Ejecting Connector Release	Recept # - 348-A188
Mushroom Pawl	Recept # - 375
Locking Mushroom Pawl	Recept # - 845
Padlock Pawl	Recept # - 843
Padlockable Mushroom Pawl	Recept # - 375- 843
Metal Pawl (on poly receptacle)	Recept # - 824
Closed Lid Configuration	Recept # - NC

Inlet Options

Part

With 2 Auxiliary/Pilot contacts	Inlet # - 172
With 3 Auxiliary/Pilot contacts	Inlet # - 173
NEMA 4X Watertightness	Inlet # - 4X
Self-Ejecting Plug Release	Inlet # - 338-A188
Straight Insertion	Inlet # - A188
With No Lockout Hole	Inlet # - A155



See pgs 197-206 for detailed information on these options

DR7c Order Example:

To order a device with a Mushroom Pawl add **-375** to the receptacle part number
DR7c 4P = 31-34940-375

Installation Accessories

Unless indicated otherwise, accessories can be used with either poly or metal plugs and receptacles

Handles



Not NEMA 3R

Makes connector closures easier

NPT	Poly Handle	Metal* Handle	Cable Range	Nylon Handle	Neoprene Handle	Poly Handle w/Clamp & Bushing	Poly Handle w/built in Draw Grips
1/2"	6PH12	6H12	.50 - 1.25	-	31-611	-	-
3/4"	6PH34	6H34	.51 - 1.38	FH611	-	-	FH611-473
1"	6PH1	6H1	1.250 - 1.375	-	-	6PM622	-
1 1/4"	6PH114	6H114	1.438 - 1.562	-	-	6PM625	-
1 1/2"	6PH112	6H112	1.562 - 1.688	-	-	6PM627	-
			1.688 - 1.812	-	-	6PM629	-

- Notes:**
- Finger draw plates are recommended for easier connector closure on cord to cord assemblies.
 - For available cord grips, see pgs 193-194.
 - * For metal devices only

Angles



Nylon 30° Angle	Metal 30° Angle	Metal 70° Angle	Metal Angle+ Oversized 30°	Metal Straight Adapter	Metal Lateral Angle 30°
MP6	MA6	89-6A027	MA660	MS6	MAB6

* Mounts on oversize box only. Order with MB10 box. See page 46.

Junction Boxes

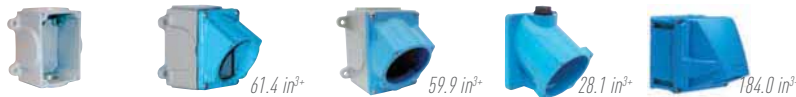

NPT	Metal Box	Metal Box with Nylon Angle	Metal Box with Metal Angle	Poly* Conduit Entry	Poly 70°** Wall Box
1/2"	-	-	-	MC612	51-DA058
3/4"	-	-	-	MC634	51-DA058
1"	MB61	31-6A053-080-1	39-6A053-080-1	MC61	51-DA058
1 1/4"	MB6114	31-6A053-080-114	39-6A053-080-114	MC6114	51-DA058
1 1/2"	MB6112	31-6A053-080-112	39-6A053-080-112	-	51-DA058
2"	MB62	31-6A053-080-2	39-6A053-080-2	-	51-DA058

- * For poly devices only ** 70° boxes are not drilled. Contact customer service if factory drilling is required.
 * Interior volume with receptacle installed.

Miscellaneous Accessories



* Set of Two (2) For Male Devices Only For Male Devices Only

Finger Drawplates	Protective Cap	Padlockable Cap Aluminum	Inlet Spring-Loaded cap
FDP6	31-6A126	DS6MC	31-6A226

* Recommended for cord to cord assembly applications, for easier connector closure

NPT Guidelines

Cable Range	NPT
.312 - .625	1/2"
.438 - .812	3/4"
.660 - 1.000	1"
.875 - 1.375	1 1/4"
.890 - 1.812	1 1/2"
1.190 - 2.438	2"
2.062 - 2.438	2 1/2"

NPT sizes are determined by the cable diameter and third party cord grip.

Order Example

A typical order should include an inlet part number, a receptacle part number **AND** the matching handles, angles or other required accessories.



Male Inlet with Handle (Plug)
31-38940 + FH611



Female Receptacle with Angle Adapter
31-34940 + MP6



Spare Parts Male Configuration

PN pictured

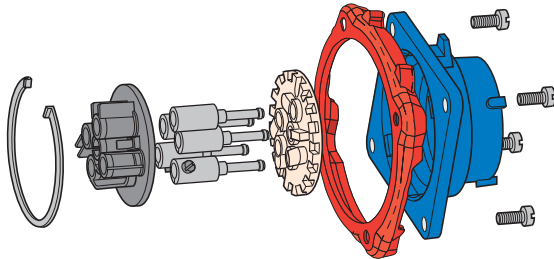

DN pictured

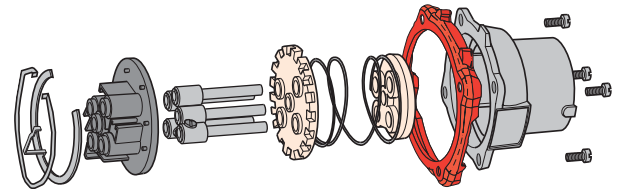

PN7c	POLY	METAL
Plug Interior, Ground Contact & Connection	09-PA910	09-PA910
Plug Contact	09-PA911	09-PA911
Device Gasket	61-1AM26	61-1AM26
Plug Casing	01-NA014	09-NA014
Ground Contact	09-PA919	09-PA919

PN12c	POLY	METAL
Plug Interior, Ground Contact & Connection	01-AA910	09-AA910
Plug Contact (Quantity = 13)*	01-AA113	01-AA113
Device Gasket	61-1AM26	61-1AM26
Plug Casing	01-NA014	09-NA014
Ground Contact (Quantity = 13)*	01-AA113	01-AA113

* If the PN12c device was purchased before March 2013, contact customer service for parts.

DSN24c / 37c	24 POLY	37 POLY
Plug Interior	61-BA910	61-CA910
Plug Contact (Quantity = 13)*	61-BA113	61-CA113
Plug Ground Contact (Quantity = 13)*	61-BA113	61-CA113
Plug Casing	61-3A014	61-6A014
Device Gasket	61-3AM26	31-3AM26

* If the DSN24c or 37c device was purchased before February 2013, contact customer service for parts.

DN9c / 20c	9 METAL	20 METAL
Plug Interior	19-1A910	19-6A910
Plug Contact (Short/Outside)	19-1A911	19-6A911
Plug Contact (Long/Inside)	19-1A711	19-6A711
Plug Ground Contact	19-1A919	19-6A919
Plug Casing	19-1A014	19-6A014
Device Gasket	31-3A026	31-9A026

DS7c / DR7c	POLY	METAL
Plug Casing	31-6A014	39-6A014
Plug Phase Contact	31-3A911	31-3A911
Plug Pilot Contact	31-3A911-172	31-3A911-172
Plug Interior	31-3A910-263	31-3A910-263
Device Gasket	31-6AM26	31-6AM26
Ground Contact	31-3A919	31-3A919

DN7c	50 METAL	90 METAL	150 METAL
Plug Casing	19-3A014	19-6A014	39-2A014
Plug Phase Contact	19-3A011-777	19-6A011-777	19-9A011-777
Plug Ground Contact	19-3A019-777	19-6A019-777	19-9A019-777
Plug Interior	19-3A010-777	19-6A010-777	19-9A010-777
Device Gasket	31-6A026	31-9A026	39-2A026

Spare Parts

Female Configuration

Multipin

PN pictured

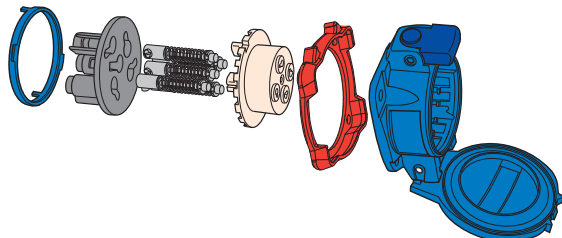

DN pictured

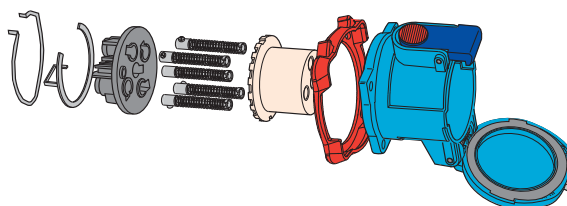

PN7c	POLY	METAL
Receptacle Interior, Ground Contact & Connection	09-PA920	09-PA920
Receptacle Contact	09-PA921	09-PA921
Device Gasket	61-1AM26	61-1AM26
Receptacle Casing	01-NA024	09-NA024
Ground Contact	09-PA929	09-PA929

PN12c	POLY	METAL
Receptacle Interior, Ground Contact & Connection*	01-AA920	09-AA920
Receptacle Contact (Quantity = 13)*	31-CA213	31-CA213
Device Gasket	61-1AM26	61-1AM26
Receptacle Casing	01-NA024	09-NA024
Ground Contact (Quantity = 13)*	31-CA213	31-CA213

* If the PN12c device was purchased before March 2013, contact customer service for parts.

DSN24c/37c	24 POLY	37 POLY
Receptacle Interior*	61-BA920	61-CA920
Receptacle Contact (Quantity = 13)*	61-BA213	61-CA213
Receptacle Ground Contact (Quantity = 13)*	61-BA213	61-CA213
Receptacle Casing	61-3A024	61-6A024
Device Gasket	61-3AM26	31-3AM26

* If the DSN24c or 37c device was purchased before February 2013, contact customer service for parts.

DN9c/20c	9 METAL	20 METAL
Receptacle Interior	19-1A920	19-6A920
Receptacle Contact (Short/Outside)	19-1A921	19-6A921
Receptacle Contact (Long/Inside)	19-1A721	19-6A721
Receptacle Ground Contact	19-1A929	19-6A929
Receptacle Casing	19-1A024	19-6A024
Lid, Gasket, Roll Pin & Spring	19-1A925	19-6A925
Device Gasket	31-3A026	31-9A026

DS7c/DR7c	POLY	METAL
Receptacle Casing	31-6A024	39-6A024
Receptacle Phase Contact	31-3A921	31-3A921
Receptacle Pilot Contact	31-3A921-172	31-3A921-172
Receptacle Interior	31-3A920-263	31-3A920-263
Device Gasket	31-6AM26	31-6AM26
Ground Contact	31-3A929	31-3A929

DN7c	50 METAL	90 METAL	150 METAL
Receptacle Casing	19-3A024	19-6A024	39-2A024-777
Receptacle Phase Contact	19-3A021-777	19-6A021-777	19-9A021-777
Receptacle Ground Contact	19-3A029-777	19-6A029-777	19-9A029-777
Receptacle Interior	19-3A020-777	19-6A020-777	19-9A020-777
Device Gasket	31-6A026	31-9A026	39-2A026

For replacement parts contact customer service at 800.433.7642

DN



Dimensions

Inlet – Provided in inches

Dimensions are for reference only and may change depending on accessories used. For precise dimensions contact Meltric Engineering.

plug

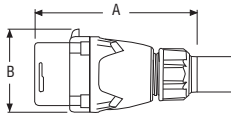

PRODUCT	A	B
DN7c(150A)	10.75	4.92
DN9c	5.79	3.39
DN7c(50A)	7.68	3.98
DN7c(90A)/DN20c	10.75	4.92

inlet with connector

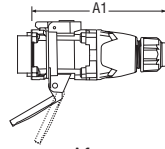

PRODUCT	A1
DN7c(150A)	12.24
DN9c	6.85
DN7c(50A)	8.35
DN7c(90A)/DN20c	12.24

inlet

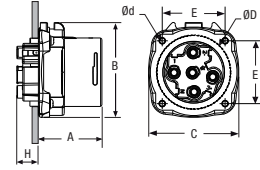

PRODUCT	A	C	E	H	Ød	ØD
DN7c(150A)	3.50	4.65	3.19	0.98	0.24	3.94
DN9c	2.01	3.19	2.17	0.59	0.20	2.68
DN7c(50A)	3.03	3.74	2.60	0.87	0.22	3.15
DN7c(90A)/DN20c	3.50	4.65	3.19	0.98	0.24	3.94

30° inclined inlet/angle with connector

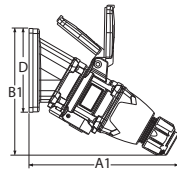

PRODUCT	A1	B1	D
DN7c(150A) 60°	12.72	10.04	5.51
DN9c	8.03	7.01	4.21
DN7c(50A)	9.53	8.66	5.35
DN7c(90A)/DN20c	12.72	10.04	5.51

30° inlet/angle

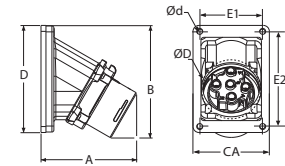

PRODUCT	A	B	CA	D	E1	E2	Ød	ØD
DN7c(150A) 60°	6.57	6.54	5.51	5.51	4.88	4.88	0.28	4.72
DN9c	3.86	4.65	2.99	4.21	2.48	3.74	0.22	2.36
DN7c(50A)	5.00	6.14	4.02	5.35	3.43	4.80	0.26	2.76
DN7c(90A)/DN20c	6.57	6.54	5.51	5.51	4.88	4.88	0.28	4.72

30° inclined inlet/angle/ junction box with connector

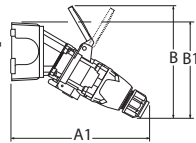

PRODUCT	A1	B	B1
DN7c(150A) 60°	15.67	16.81	13.66
DN9c	10.51	8.23	7.13
DN7c(50A)	12.60	9.21	8.86
DN7c(90A)/DN20	16.34	11.22	10.04

inlet/angle/ metal junction box

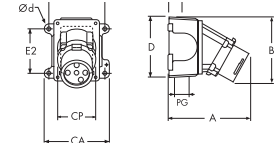

PRODUCT	A	B	CA	CP	D	E1	E2	H	PG	Ød
DN7c(150A) 60°	11.10	8.90	8.94	5.12	7.32	8.25	6.38	2.05	2.50	0.33
DN9c	6.34	4.40	4.25	3.03	4.57	3.75	2.78	1.18	1.00	0.25
DN7c(50A)	8.07	5.75	5.59	3.58	5.81	5.00	3.82	1.57	1.50	0.30
DN7c(90A)/DN20c	10.20	7.54	7.44	4.33	5.65	6.62	4.24	1.93	2.00	0.31

Dimensions

Receptacle – Provided in inches

Dimensions are for reference only and may change depending on accessories used. For precise dimensions contact Meltric Engineering.

connector

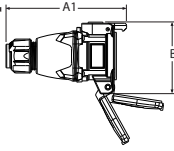

PRODUCT	A1	B
DN7c(150A)	11.22	5.31
DN9c	6.65	3.86
DN7c(50A)	7.87	4.53
DN7c(90A)/DN20c	11.22	5.31

receptacle with plug

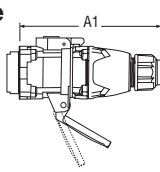

PRODUCT	A1
DN7c(150A)	12.24
DN9c	6.85
DN7c(50A)	8.35
DN7c(90A)/DN20c	12.24

receptacle

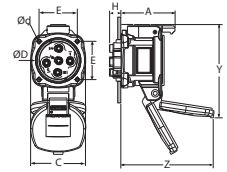

PRODUCT	A	C	E	H	Y	Z	Ød	ØD
DN7c(150A)	4.33	4.65	3.19	0.94	5.20	7.68	0.24	3.94
DN9c	2.87	3.19	2.17	0.59	3.86	4.92	0.20	2.68
DN7c(50A)	3.82	3.74	2.60	0.87	4.53	5.71	0.22	3.15
DN7c(90A)/DN20c	4.33	4.65	3.19	0.94	5.20	7.68	0.24	3.94

30° inclined receptacle/angle with plug

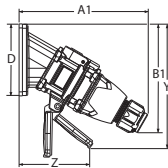

PRODUCT	A1	B1	D	Y	Z
DN7c(150A)	13.78	10.43	5.51	10.75	7.17
DN9c	4.09	7.01	4.21	8.03	4.13
DN7c(50A)	9.53	8.66	5.35	9.49	4.72
DN7c(90A)/DN20c	13.78	10.43	5.51	10.75	7.17

30° receptacle/angle

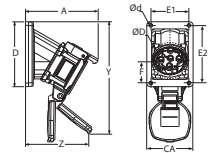

PRODUCT	A	CA	D	E1	E2	F	Y	Z	Ød	ØD
DN7c(150A) 60°	7.68	5.51	5.51	4.88	4.88	2.42	10.75	7.17	0.28	4.72
DN9c	5.00	2.99	4.21	2.48	3.74	1.57	8.03	4.13	0.22	2.36
DN7c(50A)	6.06	4.02	5.35	3.43	4.80	1.97	9.49	4.72	0.26	2.76
DN7c(90A)/DN20c	7.68	5.51	5.51	4.88	4.88	2.42	10.75	7.17	0.28	4.72

30° inclined receptacle/angle/junction box with plug

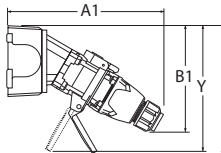

PRODUCT	A1	B1	Y
DN7c(150A) 60°	15.67	13.66	11.54
DN9c	6.57	7.13	8.15
DN7c(50A)	12.60	8.86	9.69
DN7c(90A)/DN20c	16.34	10.04	10.75

receptacle/angle/metal junction box

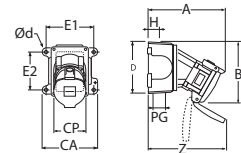

PRODUCT	A	B	CA	CP	D	E1	E2	H	PG	Y	Z	Ød
DN7c(150A) 60°	12.95	9.80	8.94	5.16	7.32	8.25	6.38	2.05	2.50	14.96	11.89	0.33
DN9c	7.48	6.89	4.40	2.91	4.57	3.75	2.78	1.18	1.00	8.15	6.61	0.25
DN7c(50A)	9.13	8.43	5.75	3.50	5.81	5.00	3.82	1.57	1.50	9.69	7.80	0.30
DN7c(90A)/DN20c	11.31	9.33	7.54	4.41	5.65	6.62	4.24	1.93	2.00	10.75	10.79	0.31

PF / PFQ



Features and Ratings	p. 128
PF / PFQ 300-600A	p. 129
Spare parts	p. 131
Dimensions	p. 132



High amperage plugs & receptacles

PF and PFQ Series plugs and receptacles are engineered for use in high amperage applications where routine plug insertion and high reliability are required. They are ideal for power supply applications in mining, petroleum platform, ship to shore, power generation system, shipyard and other similar harsh environments.

Main Advantages

- ▶ Durable in harsh environments
- ▶ Safety features provide maximum protection
- ▶ Easy plug insertion and removal



PFQ300 devices are differentiated from similarly rated **PF300** devices in their smaller size, lighter weight and different pilot contacts.

Product Features

Auxiliary Pilot Contacts

Provided for use with control circuits. They close after and open before the phase contacts.

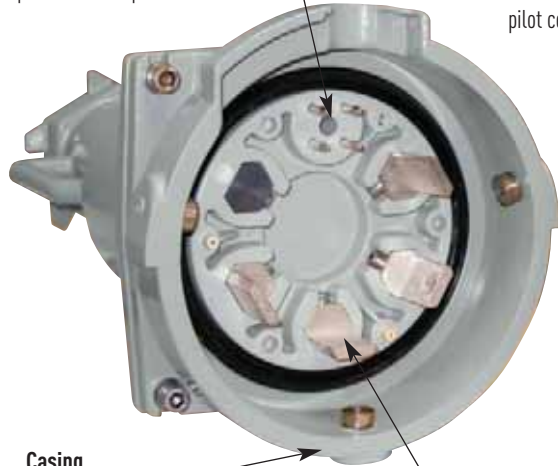

Mechanical Locking System

Ensures safety and watertightness. Mechanical lock secures the inlet to the receptacle and engages the pilot contacts.



Casing

Epoxy/powder coated aluminum material offers great resistance to harsh environments.

Silver Pressure Contacts

Silver material and self-cleaning action provides maximum conductivity and performance in dirty and corrosive conditions.

Safety Shutter

Protects recessed female contacts and inhibits user access to live parts.

General Ratings

Amperage	300 to 600A
Voltage*	1000 VAC*, 1000 VDC Max
Frequency	50-400 Hz
Environmental	IP66+IP67
Temperature	min -40°F/max 140°F

* 600 VAC max for PFQ devices

+ UL listings do not apply above 600 VAC and 250 VDC

Listings

Category	UL	CSA
Plugs and Receptacles	UL 1682*	C22.2 No. 182.1*

* Listings only apply to 300A and 400A devices at 600V or less



PFQ300 devices are differentiated from similarly rated PF300 devices in their smaller size, lighter weight and different pilot contacts.

Highlighted Feature

Pilot Contacts

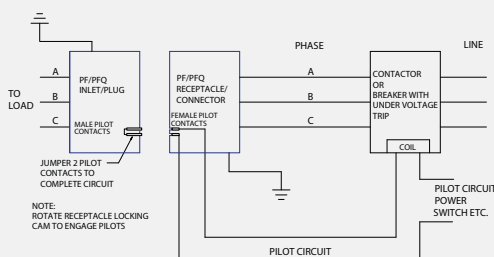

Line diagram of typical PF pilot control circuit

Notes: • The mechanical locking of the plug to the receptacle, via the rotation of a cam, closes the pilot contacts.

• Failure to use a pilot/relay system can create an electrical shock hazard.

Operating Instructions



PF devices are preferred for the ease of operation relative to pin and sleeve devices.

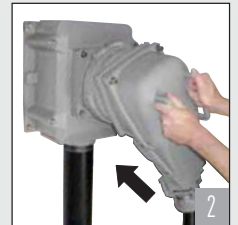

Insert the plug into the receptacle – this is done with little resistance relative to competitive devices.



Twist plug approximately 30° clockwise to engage the phase contacts and make unit watertight.



Turning the mechanical lock secures the inlet to the receptacle and engages the pilot contacts which energize the circuit.

5 To disconnect, turn mechanical lock to disengage pilot contacts and de-energize the circuit. Twist plug 30° counterclockwise to disengage the phase contacts, withdraw plug.

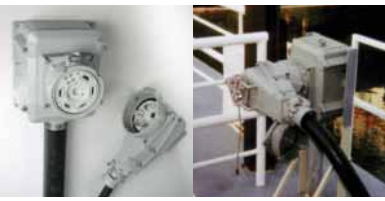

PF/PFQ – 300A - 600A

High Ampacity Plugs & Receptacles

Ratings

- Voltage**
PF = 1000 VAC*, 250 VDC
PFQ = 600 VAC, 250 VDC
 - Current Interruption Capability**
Not for current interrupting
 - Environmental Ratings**
IP66+IP67
 - Temperature Range**
Min -40°F/Max 140°F
See pg 220 for temps below -15°F.
 - Wiring Capacity**
PFQ = 2 AWG to 600 MCM
PF = 2 AWG to 600 MCM
 - Listings**
UL*, CSA*
- * Listings apply only to 300A & 400A devices at 600V or less

Receptacle/Cap (female)

300A



Don't forget to add installation accessories to your order

PFQ shown

Voltage	Polarity	Part #	
		PFQ300**	PF300
277V	1P+N+G	47-34045	49-34045
347V	1P+N+G	47-34145	49-34145
480V	2P+G	47-34042	49-34042
480V	2P+N+G	47-34046	49-34046
480V	3P+G	47-34043	49-34043
480V	3P+N+G	47-34047	49-34047
600V	2P+G	47-34142	49-34142
600V	2P+N+G	47-34146	49-34146
600V	3P+G	47-34143	49-34143
600V	3P+N+G	47-34147	49-34147

Inlet/Cap (male)

300A



PFQ shown

Voltage	Polarity	Part #	
		PFQ300**	PF300
277V	1P+N+G	47-38045	49-38045
347V	1P+N+G	47-38145	49-38145
480V	2P+G	47-38042	49-38042
480V	2P+N+G	47-38046	49-38046
480V	3P+G	47-38043	49-38043
480V	3P+N+G	47-38047	49-38047
600V	2P+G	47-38142	49-38142
600V	2P+N+G	47-38146	49-38146
600V	3P+G	47-38143	49-38143
600V	3P+N+G	47-38147	49-38147

Other voltage configurations are available – contact customer service at 800.433.7642.

** PFQ300 devices are differentiated from similarly rated PF300 devices in their smaller size, lighter weight and different pilot contacts.

Main Options

Receptacle with no cap	Recept # - 48
Receptacle with lockout hole	Recept # - 843
Inlet with no cap	Inlet # - 48
Inlet with lockout hole	Inlet # - 843

Notes: • Metal caps are provided as standard with male and female devices.

• Heat shrink wrap is provided with each inlet and receptacle to provide insulation between terminals.

PF/PFQ devices are not intended for connection or disconnection under load. To prevent live making or breaking electrical interlocking is required.

Receptacle/Cap (female)

400A/600A



For applications above 400A, please consult factory regarding NEC recommended conductor sizing.

Voltage	Polarity	Part #	
		PF400	PF600
277V	1P+N+G	49-44045	49-64045
347V	1P+N+G	49-44145	49-64145
480V	2P+G	49-44042	49-64042
480V	2P+N+G	49-44046	49-64046
480V	3P+G	49-44043	49-64043
480V	3P+N+G	49-44047	49-64047
600V	2P+G	49-44142	49-64142
600V	2P+N+G	49-44146	49-64146
600V	3P+G	49-44143	49-64143
600V	3P+N+G	49-44147	49-64147

Inlet/Cap (male)

400A/600A



Voltage	Polarity	Part #	
		PF400	PF600
277V	1P+N+G	49-48045	49-68045
347V	1P+N+G	49-48145	49-68145
480V	2P+G	49-48042	49-68042
480V	2P+N+G	49-48046	49-68046
480V	3P+G	49-48043	49-68043
480V	3P+N+G	49-48047	49-68047
600V	2P+G	49-48142	49-68142
600V	2P+N+G	49-48146	49-68146
600V	3P+G	49-48143	49-68143
600V	3P+N+G	49-48147	49-68147

Installation Accessories

Handles



Inlet/Receptacle Size	Metal Straight Handle	Metal 90° Angled Handle
PFQ300	47-3A013-XXX	47-3A913-XXX
PF300	49-3A013-XXX	49-3A913-XXX
PF400	49-4A013-XXX	49-4A913-XXX
PF600	49-6A013-XXX	49-6A913-XXX



XXX (Suffix #)	Cable Range
-200	2.000 - 2.125
-225	2.125 - 2.250
-237	2.250 - 2.375
-250	2.375 - 2.500
-275	2.500 - 2.750
-300	2.750 - 3.000
-312	3.000 - 3.125
-335	3.125 - 3.350
-350	3.350 - 3.390



XXX (Suffix #)	NPT Size
-N20	2.0" NPT
-N25	2.5" NPT
-N30	3.0" NPT

Notes: • For available cord grips, see pgs 193-194.

Junction Boxes



Inlet/Receptacle Size	Hub Sizes	Metal Junction Box
PFQ300	See table	MB40PFQ-XX
PF300	See table	MB40-XX
PF400	See table	MB40-XX
PF600	See table	MB40-XX

Hub Sizes

XX (Suffix #)	Fitting Size
-20	2" NPT
-25	2.5" NPT
-30	3" NPT
-35	3.5" NPT
-40	4" NPT

Miscellaneous Accessories



Inlet/Receptacle Size	Inlet Replacement Metal Cap	Receptacle Replacement Metal Cap
PFQ300	47-3A126	47-3A925
PF300	49-3A126	49-3A925
PF400	49-4A126	49-4A925
PF600	49-6A126	49-6A925

Weights

Part	PF	PFQ
Inlet	15 lbs	9 lbs
Receptacle	25 lbs	12 lbs
Angled Handle	15 lbs	12 lbs
Straight Handle	10 lbs	10 lbs
Junction Box	45 lbs	45 lbs
Cap	3 lbs	3 lbs

Accessory Spotlight



NPT Adapter

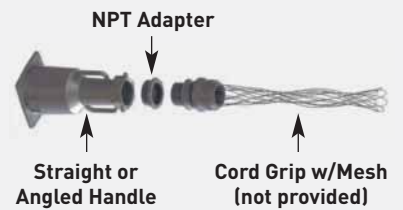

A NPT adapter accessory allows the user to connect a third party cord grip to the PF/PFQ handle.

Order Example

A typical order should include an inlet part number, a receptacle part number **AND** the matching handles, angles or other required accessories.



Male Inlet with Handle (Plug)
47-38047 + 47-3A913-200



Female Receptacle with Junction Box
47-34047 + MB40-20



Spare Parts

Male Configuration

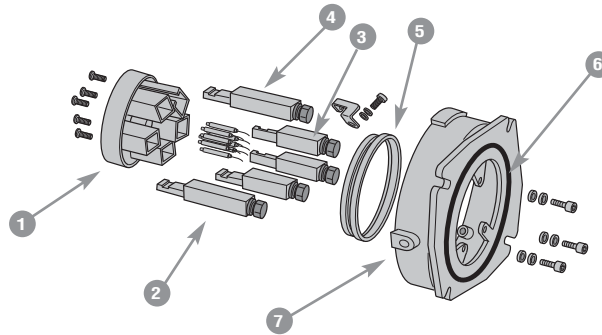

	PFQ300 METAL	PF300 METAL	PF400 METAL	PF600 METAL
1 = Plug Interior*	47-3A010	49-3A010	49-4A010	49-6A010
1 = Plug Interior with contacts** (Pilot & Ground only)	47-3A110	49-3A110	49-4A110	49-6A110
2 = Phase Contact	47-3A011	49-3A011	49-4A011	49-6A011
3 = Neutral Contact	47-3A011N	49-4A011N	49-4A011N	49-6A011N
4 = Ground Contact	47-3A019	49-4A019	49-4A019	49-6A019
5 = Inside Gasket	CPF403PFQ	CPF403	CPF403	CPF403
6 = Outside Gasket	CPF405PFQ	CPF405	CPF405	CPF405
7 = Plug Metal Casing*	47-3A014	49-3A014	49-4A014	49-6A014

Female Configuration

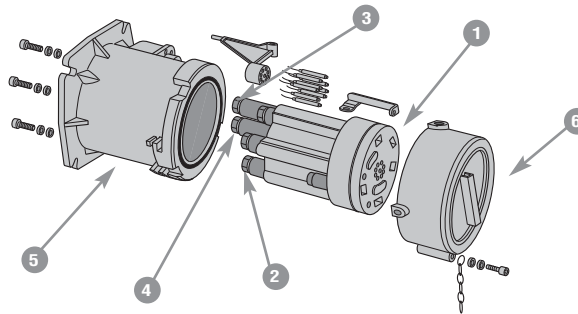

	PFQ300 METAL	PF300 METAL	PF400 METAL	PF600 METAL
1 = Receptacle Interior*	47-3A020	49-3A020	49-4A020	49-6A020
1 = Receptacle Interior with contacts** (Pilot & Ground only)	47-3A220	49-3A220	49-4A220	49-6A220
2 = Phase Contact	47-3A021	49-3A021	49-4A021	49-6A021
3 = Neutral Contact	47-3A021N	49-3A021N	49-4A021N	49-6A021N
4 = Ground Contact	47-3A029	49-3A029	49-4A029	49-6A029
5 = Receptacle Metal Casing*	47-3A024	49-3A024	49-4A024	49-6A024
6 = Cap (Receptacle)	47-3A925	49-3A925	49-3A925	49-3A925
Inside Gasket (Not Shown)	CPF403PFQ	CPF403	CPF403	CPF403
Outside Gasket (Not Shown)	CPF405PFQ	CPF405	CPF405	CPF405

* Voltage and phasing positions must be specified (5th, 6th and 7th digit of part #)
 ** Includes ground and pilot contacts only

For replacement parts call the Meltric office.

Dimensions

Inlet/Receptacle – Provided in inches

Dimensions are for reference only and may change depending on accessories used. For precise dimensions contact Meltric Engineering.

straight plug

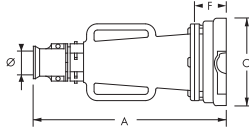

PRODUCT	A	C	F	Ø
PFQ	23.03	7.72	2.95	2.0-3.5
PF	26.57	9.06	3.74	2.0-3.5

inlet

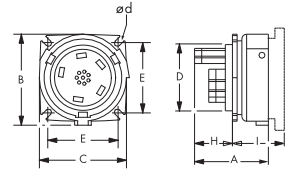

PRODUCT	A	B	C	D	E	H	I	Ød
PFQ	6.10	9.45	7.72	5.31	5.75	3.15	6.89	0.43
PF	7.68	10.47	9.06	6.89	7.48	3.94	8.27	0.43

angled plug

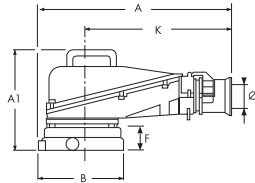

PRODUCT	A	A1	B	F	K	Ø
PFQ	18.50	11.50	9.45	2.95	13.86	2.0-3.5
PF	23.43	12.60	10.47	3.74	17.99	2.0-3.5

inlet on surface box

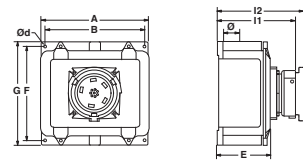

PRODUCT	A	B	E	F	G	I1	I2	Ø	Ød
PFQ/PF	15.70	14.63		13.75	15.15			2.0-4.0	0.41
PFQ	15.70	14.63	8.62	13.75	15.15	11.62	16.87	2.0-4.0	0.41
PF	15.70	14.63	8.81	13.75	15.15	12.56	19.44	2.0-4.0	0.41

straight connector

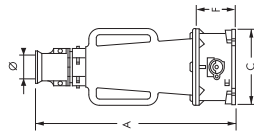

PRODUCT	A	C	F	Ø
PFQ	24.72	7.72	4.65	2.0-3.5
PF	27.56	9.06	4.72	2.0-3.5

receptacle

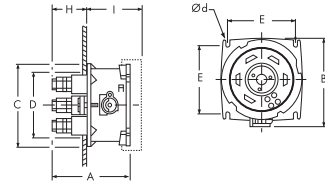

PRODUCT	A	B	C	D	E	H	I	Ød
PFQ	7.64	9.45	7.72	5.51	5.75	2.99	6.89	0.39
PF	8.66	9.84	9.06	7.28	7.48	3.94	8.27	0.39

angled connector

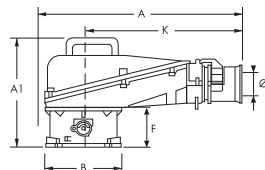

PRODUCT	A	A1	B	F	K	Ø
PFQ	18.50	13.15	9.45	4.65	14.65	2.0-3.5
PF	23.43	13.39	9.84	4.72	17.99	2.0-3.5

receptacle on surface box

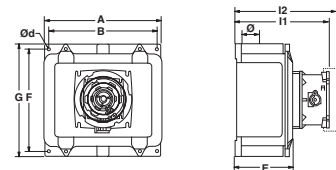

PRODUCT	A	B	E	F	G	I1	I2	Ø	Ød
PFQ/PF	15.70	14.63		13.75	15.15			2.0-4.0	0.41
PFQ	15.70	14.63	8.62	13.75	15.15	13.24	15.74	2.0-4.0	0.41
PF	15.70	14.63	8.81	13.75	15.15	13.68	19.68	2.0-4.0	0.41

SP

Features and Ratings p. 134

SP Parts p. 135

Dimensions p. 136



Single Pole, High Amperage Plugs & Receptacles

SP devices are designed for safety, durability and ease of operation. SP receptacles are IP 2X rated to prevent accidental finger contact with live parts and are also equipped with pilot contacts for controlling the power circuit. The pilot contacts are interlocked with the latching mechanism to prevent connection or disconnection under load.

Five different mechanical keying positions for L1, L2, L3, N and E prevent accidental insertion of the wrong plug into a receptacle. Color coding simplifies identification of mating devices.

Main Advantages

- ▶ Safety features provide maximum protection
- ▶ Silver, butt-style contact technology maximizes durability
- ▶ IP66+IP67 environmental protection when mated

Product Features

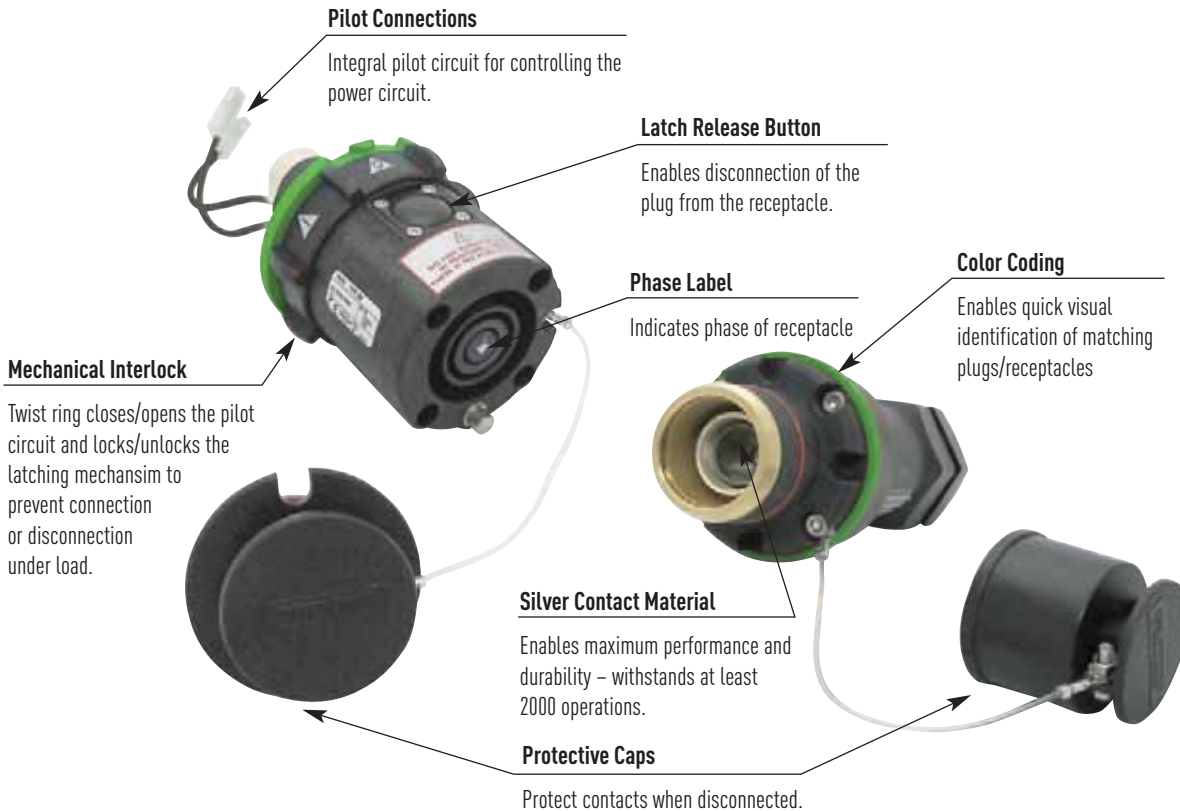

General Ratings

Listing	CSA	IEC
Amperage	600A	700A
Voltage	600 VAC	1000 VAC / 1500 VDC Max
Frequency	50-400 Hz	50-400 Hz
Environmental	IP66+IP67	IP66+IP67
Temperature	min -15°F / max 140°F	min -15°F / max 140°F

Highlighted Feature

Pilot Circuit



SP plugs and connectors are designed with safety and durability in mind. Each device is mechanically interlocked with an integral pilot circuit switch for controlling the power circuit in order to prevent connection and disconnection under load.

A typical pilot circuit wiring diagram

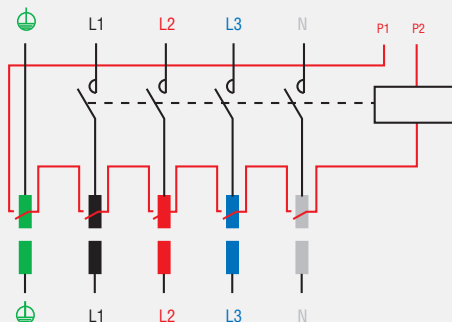

Operating Instructions



To connect, insert the plug into the receptacle until a click is heard. Rotation of the plug in either direction engages a locking finger, which prevents further rotation.



To close the pilot circuit and mechanically lock the plug into the receptacle, turn the ring on the receptacle until the "1" lines up with the arrow. This turns the power on.



To disconnect, open the pilot circuit and unlock the plug by turning the ring until the "0" is aligned with the arrow. The power is now off.



Press firmly on the latch release button and simultaneously pull on the inlet. A slight rotation of the plug may also be required.

SP



SP – 600A

Single Pole Plugs & Receptacles

Ratings

- Voltage**
600 VAC
Contact customer service to order devices for international applications and for IEC listings up to 700A, 1000 VAC/1500 VDC.
- Current Interruption Capability**
Non-Load break
- Horsepower Ratings**

480V	3Ø	500 hp
600V	3Ø	500 hp

CSA HP rated when auxiliary pilots are wired to control motor control circuit.
- Environmental Ratings**
IP66+IP67
- Temperature Range**
Min -15°F/Max 140°F
- Wiring Capacity**
Min 2/0 Max 777 MCM
Aux Contacts 12-14 AWG
- Listings**
CSA (IEC, CE optional)
* Contact Customer Service
- Pilot Contact Amperage**
1A, 240 VAC

Receptacle (female) without lug



Don't forget to add installation accessories to your order

Inlet (male) without lug



Color Code	Polarity	Part # without lug
Black	L1	45-44001-P80
Red	L2	45-44002-P80
Blue	L3	45-44003-P80
White	NEUTRAL	45-4400N-P80
Green	GROUND	45-4400T-P80
Red	POSITIVE	45-4400P*
Black	NEGATIVE	45-4400M*
Green	GROUND	45-4400T*

Color Code	Polarity	Part # without lug
Black	L1	45-48001-P80
Red	L2	45-48002-P80
Blue	L3	45-48003-P80
White	NEUTRAL	45-4800N-P80
Green	GROUND	45-4800T-P80
Red	POSITIVE	45-4800P*
Black	NEGATIVE	45-4800M*
Green	GROUND	45-4800T*

Notes:

- Not CSA listed. CE rated up to 700A, 1000 VAC/1500 DC
- Pilot contacts are AC/DC rated for 6A and 250V

Crimping lug*



Handle



Angle Option



Inclined Metal Angle 45°

Part #

Angle 45-4A027

Flexible MCM+ Wire Size	Straight with Terminal	Straight Threaded**
4/0	45-4A95C	45-4A95D
250	45-4A12C	45-4A12D
300	45-4A15C	45-4A15D
350	45-4A18C	45-4A18D
500	45-4A24C	45-4A24D
600	45-4A30C	45-4A30D
777	45-4A40C	45-4A40D

Cable Outside Diameter	Part #
.750 - .875	45-4A753-A
.875 - 1.000	45-4A753-B
1.000 - 1.125	45-4A753-C
1.125 - 1.250	45-4A753-D
1.250 - 1.375	45-4A753-E
1.250 - 1.375	45-4A783-A
1.312 - 1.437	45-4A783-B
1.438 - 1.562	45-4A783-C
1.562 - 1.688	45-4A783-D

* Use the straight threaded lug when cord mounting with handle accessory
 ** Straight threaded lug can be used for solder connection as well as crimp connection
 Lugs should be crimped using a dieless indent style crimping tool
 + Based on flexible type copper cables. See appropriate NEC tables for applicable ampacities

Dimensions



Inlet & Receptacle- Provided in inches

Dimensions are for reference only and may change depending on accessories used. For precise dimensions contact Meltric Engineering.

inlet

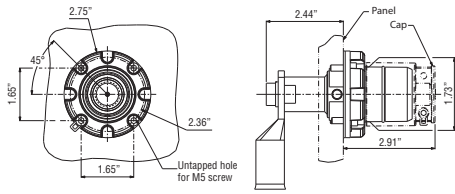

receptacle

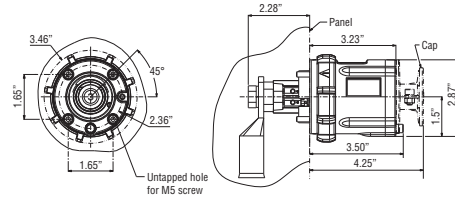

plug

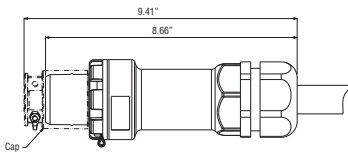

plug / connector

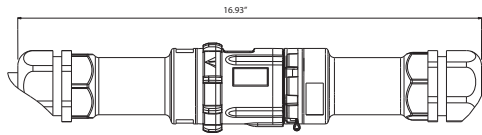

connector

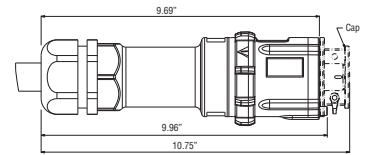

plug with connector on/off

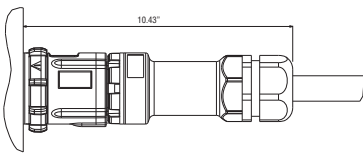

connector with plug on/off

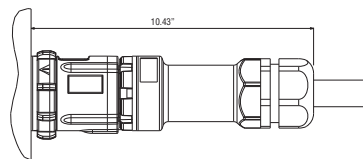

45° inclined receptacle/angle with plug

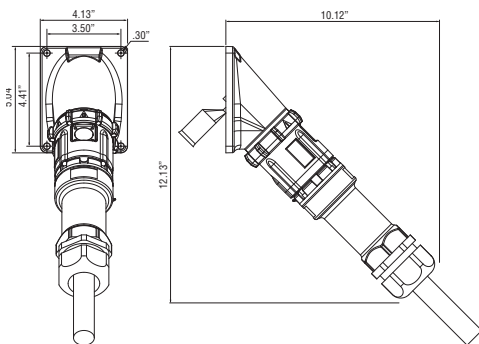

45° inclined inlet/angle with connector

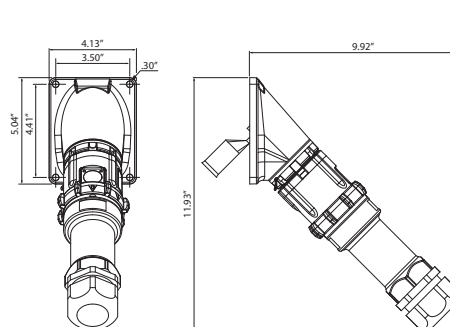

CS1000

NEW
Product

Features and Ratings p. 138

CS1000 p. 139

Dimensions p. 140



Single Pole Power Connectors

The CS1000 devices are designed to be a new industry standard for safety, usability, reliability, performance and durability. The CS1000 Series provides safety features that are not currently offered by other single pole devices. These safety features include: IP2X finger protection that protects users from live parts, mechanical keying system prevents insertion of the wrong phases, a locking pin that prevents accidental disconnection, and a plug/receptacle that accepts different cable sizes. The standard features of CS1000 Series include solid silver-nickel contacts, spring-loaded, butt-style contact technology and IP66 + IP67 environmental protection.

Main Advantages

- ▶ High Amperage Capacity up to 400A, 1000VAC.
- ▶ Safety features protect users from live parts and prevent unwanted disconnection.
- ▶ Silver-nickel butt contacts provide superior performance and corrosion resistance.

Product Features



Operating Instructions

Connection



Disconnection



General Ratings

Amperage	400A
Voltage	1000 VAC, 1500 VDC
Frequency	50-400 Hz
Environmental	IP66/IP67
Temperature	min -40°F/max 185°F

Highlighted Feature

5 Mechanical Keying Postions
(North America color codes shown.)

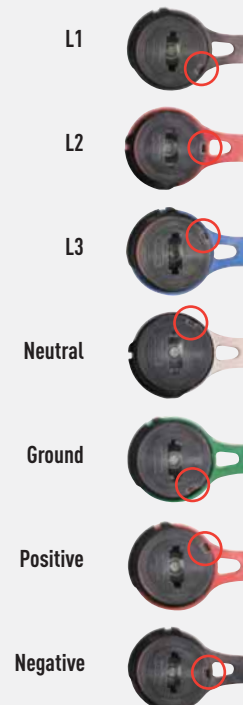



CS1000 – 400A - 1000 VAC Standard Duty Plugs & Receptacles

Ratings

- **Amperage**
400A
- **Voltage**
1000 VAC, 1500 VDC
- **Environmental Ratings**
IP66+IP67
- **Temperature Range**
Min -40°F / Max 140°F
- **Wiring Capacity**
Min 1/0 AWG / Max 450 MCM
- **Listings**
Consult Factory

Recommendation

Use these part numbers if the devices will be utilized in North America.

Recommendation

Use these part numbers if the devices will be utilized in Europe.

Receptacle (female) without lug



Don't forget to add installation accessories to your order

Inlet (male) without lug



North American Color Code	Polarity	Part # without lug
	L1	45-34001-P80
	L2	45-34002-P80
	L3	45-34003-P80
	NEUTRAL	45-3400N-P80
	GROUND	45-3400T-P80
	POSITIVE	45-3400P-P80
	NEGATIVE	45-3400M-P80

European Color Code	Polarity	Part # without lug
	L1	45-34001
	L2	45-34002
	L3	45-34003
	NEUTRAL	45-3400N
	GROUND	45-3400T
	POSITIVE	45-3400P
	NEGATIVE	45-3400M

North American Color Code	Polarity	Part # without lug
	L1	45-38001-P80
	L2	45-38002-P80
	L3	45-38003-P80
	NEUTRAL	45-3800N-P80
	GROUND	45-3800T-P80
	POSITIVE	45-3800P-P80
	NEGATIVE	45-3800M-P80

European Color Code	Polarity	Part # without lug
	L1	45-38001
	L2	45-38002
	L3	45-38003
	NEUTRAL	45-3800N
	GROUND	45-3800T
	POSITIVE	45-3800P
	NEGATIVE	45-3800M

Angle Options



Adapter Plate Only

Part #

Adapter Plate 45-3A540



Inclined Angle 30° with Adapter Plate

Part #

30° Angle 45-3A027

Installation Accessories

Angles



w/Adapter Plate

Angle 30°

45-3A027



Required for mounting on panels, walls, etc.

Adapter Plate

45-3A540

Accessories



Inlet Cap

45-3A126



Unlocking Tool *

45-3A396



Padlocking Tool

45-3A844

* One unlocking tool on a "valet" style separable key ring is included with each male inlet

Installation Accessories

Crimping lug

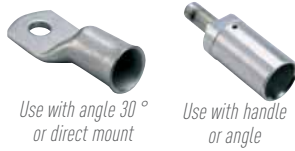

Measured Internal Dia. (in)	Flexible Wire Size	Straight with Terminal	Straight Threaded
.43	1/0	45-3A50C	45-3A50D
.52	3/0	45-3A70C	45-3A70D
.57	4/0	45-3A95C	45-3A95D
.64	250	45-3A12C	45-3A12D
.70	300	45-3A15C	45-3A15D
.80	350	45-4A18C	45-4A18D
.90	450	45-4A24C	45-4A24D

Handle



Cable Outside Diameter	Part #
.550 - 1.000	45-3A753
.700 - 1.260	45-3A783

Handle w/Cord Grip (Mesh)



Cable Outside Diameter	Part #
.500 - .625	45-3A753-A
.562 - .688	45-3A753-B
.625 - .750	45-3A753-C
.688 - .812	45-3A753-D
.750 - .875	45-3A753-E
.875 - 1.000	45-3A783-A
1.000 - 1.125	45-3A783-B
1.125 - 1.250	45-3A783-C
1.250 - 1.375	45-3A783-D

Dimensions Provided in inches

Dimensions are for reference only and may change depending on accessories used. For precise dimensions contact Meltric Engineering.

receptacle

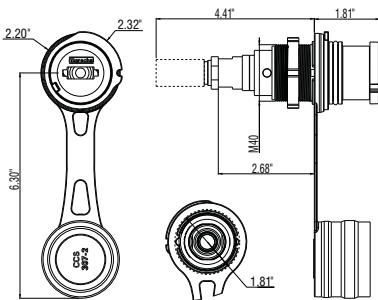

plug/receptacle

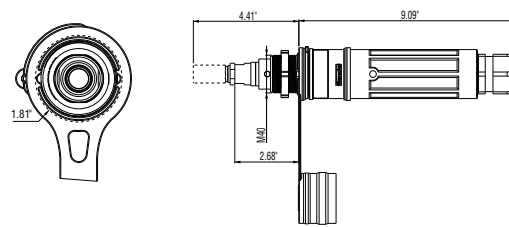

inline connector

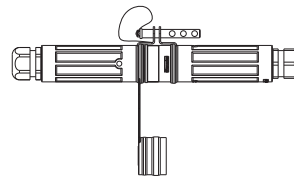

30° inclined receptacle/angle

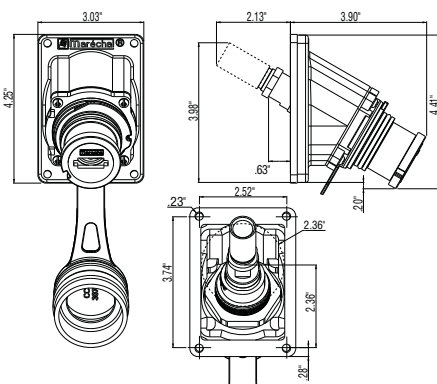

30° receptacle/angle with plug

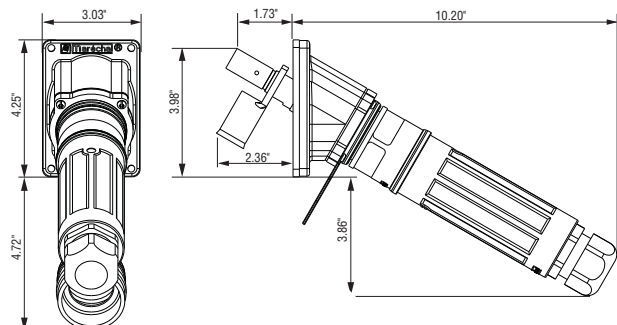

DR



Features and Ratings	p. 141
DR30	p. 143
DR50	p. 145
DR100	p. 147
DR150	p. 149
DR 250	p. 151
Spare parts	p. 153
Dimensions	p. 155



Robust construction and high amperage capabilities

DR series plugs and receptacles provide safe, economical and robust connections for applications up to 250A. Some DR models are non-current interrupting rated, while others are suitable for current interruption on resistive loads (see table on next page). The DR's spring-loaded, silver-nickel butt contacts and dead front construction provide more consistent and reliable connections and significant improvements in operator safety compared to competitive devices.

Main Advantages

- ▶ High amperage capacity
- ▶ Up to 6 auxiliary contacts
- ▶ Robust Metal or Poly construction

Product Features

DSN pictured

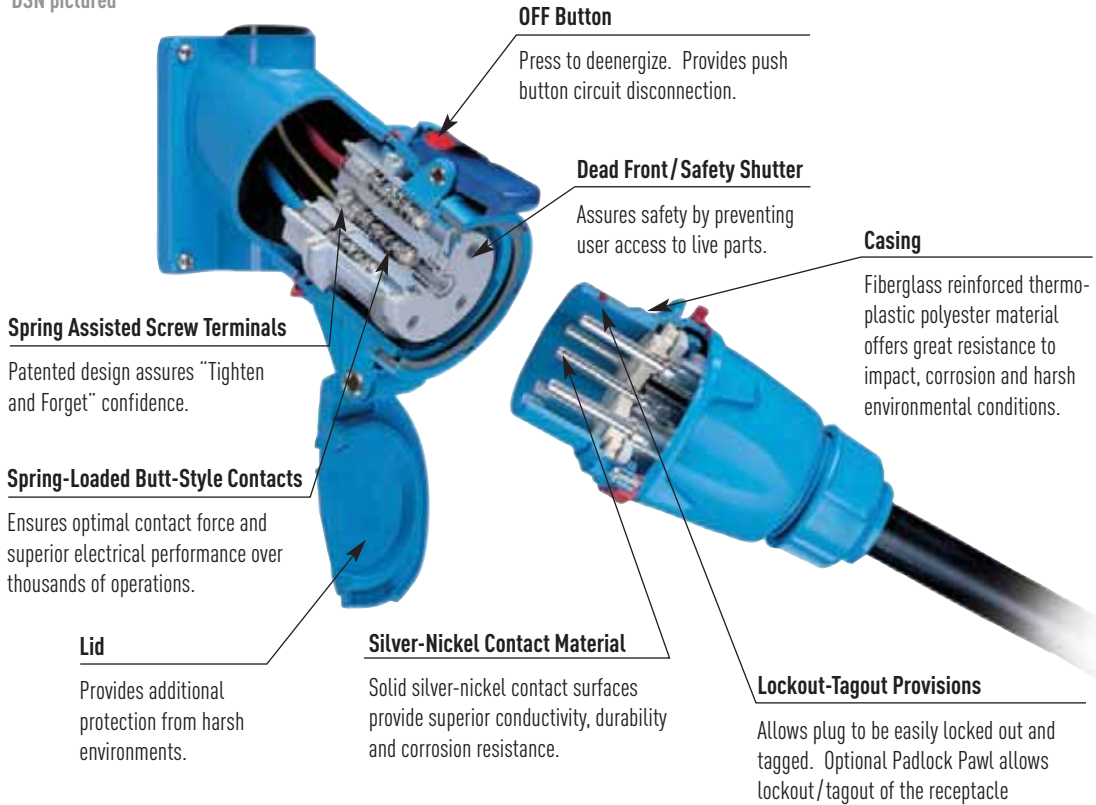

OFF Button

Press to deenergize. Provides push button circuit disconnection.

Dead Front/Safety Shutter

Assures safety by preventing user access to live parts.

Casing

Fiberglass reinforced thermo-plastic polyester material offers great resistance to impact, corrosion and harsh environmental conditions.

Spring Assisted Screw Terminals

Patented design assures "Tighten and Forget" confidence.

Spring-Loaded Butt-Style Contacts

Ensures optimal contact force and superior electrical performance over thousands of operations.

Lid

Provides additional protection from harsh environments.

Silver-Nickel Contact Material

Solid silver-nickel contact surfaces provide superior conductivity, durability and corrosion resistance.

Lockout-Tagout Provisions

Allows plug to be easily locked out and tagged. Optional Padlock Pawl allows lockout/tagout of the receptacle

Operating Instructions



When the plug and receptacle are latched together, the circuit is connected.



Pressing the pawl causes the DR to break the circuit. The plug is ejected to its rest position; its contacts are now dead.



Rotating the 'dead' plug 30° counterclockwise closes the safety shutter and frees the plug to be withdrawn from the receptacle.



The plug and the receptacle are separated. The safety shutter prevents access to live parts.

5 To reconnect, insert plug into receptacle, twist slightly, and apply insertion force.

General Ratings

Amperage	30 to 250A
Voltage	600 VAC
Frequency	50-400 Hz
Short-Circuit (Withstand)	10kA to 100kA*
Environmental	Type 3R, IP54/IP55**
Temperature	min -40°F/max 140°F

* DR30, 50 and 100 are 100kA; DR150 and 250 are 10kA
Testing was performed with RK1 current limiting fuses sized at at least 100% of the devices ampacity ratings.

** IP54 rated when receptacle and plug are mated, when not mated receptacle alone is IP55 rated provided that the lid is latched closed.

Current Interruption Listings

Model	Current Interruption Capabilities
DR30	Not for current interrupting
DR50	For current interrupting up to 250 VAC***
DR100	For current interrupting up to 600 VAC***
DR150	For current interrupting up to 250 VAC***
DR250	Not for current interrupting

*** Devices rated for current interrupting are not intended for repetitive switching duties.

Listings

Category	UL	CSA	IEC
Plugs and Receptacles	UL 1682	C22.2 No. 182.1	60309-1

CE ratings available upon request

DR30



DR – 30A Standard Duty Plugs & Receptacles

Ratings

- Voltage**
600 VAC
- Current Interruption Capability**
Not for current interrupting
For Switch-Rated devices, see DS & DSN sections.
- Short Circuit Rating**
100kA
Testing was performed with RK1 current limiting fuses sized at least 100% of the devices ampacity rating.
- Environmental Ratings**
Type 3R, IP54/IP55*
* IP54 when the plug & receptacle are mated. IP55 on the receptacle alone when the lid is latched closed.
- Temperature Range**
Min -40°F/Max 140°F
See pg 220 for temps below -15°F.
- Wiring Capacity**
Min 14 AWG Max 8 AWG
Aux Contacts - Max 14 AWG
* Based on THHN wire sizes
- Listings**
UL, CSA, IEC, CE*
* Contact Customer Service

Receptacle (female)



Don't forget to add installation accessories to your order

Inlet (male)



Voltage	Polarity	Part # Poly
120/208V	3P+N+G	31-14237-K16
125V	1P+N+G	31-14175-K07
125/250V	2P+N+G	31-14176-K07
208V	2P+G	31-14232-K16
208V	3P+G	31-14233-K16
250V	2P+G	31-14172-K07
250V	3P+G	31-14173-K07
277V	1P+N+G	31-14245-K04
277/480V	3P+N+G	31-14247-K04
347/600V	3P+N+G	31-14187-K14
480V	2P+G	31-14242-K04
480V	3P+G	31-14243-K04
600V	2P+G	31-14182-K14
600V	3P+G	31-14183-K14

Voltage	Polarity	Part # Poly
120/208V	3P+N+G	31-18237-K16
125V	1P+N+G	31-18175-K07
125/250V	2P+N+G	31-18176-K07
208V	2P+G	31-18232-K16
208V	3P+G	31-18233-K16
250V	2P+G	31-18172-K07
250V	3P+G	31-18173-K07
277V	1P+N+G	31-18245-K04
277/480V	3P+N+G	31-18247-K04
347/600V	3P+N+G	31-18187-K14
480V	2P+G	31-18242-K04
480V	3P+G	31-18243-K04
600V	2P+G	31-18182-K14
600V	3P+G	31-18183-K14

Other voltage configurations are available – contact customer service at 800.433.7642.

Main Options



Auxiliary Contacts



Mushroom Pawl



Padlock Pawl



Closed Lid Configuration

Recommended for cord applications to keep lid tucked in to avoid damage.

Receptacle Options	Part #
With 2 Auxiliary/Pilot Contacts	Recept # - 972
Type 4X & closed lid configuration	Recept # - 4X
Mushroom Pawl	Recept # - 375
Padlock Pawl	Recept # - 843
Padlockable Mushroom Pawl	Recept # -375-843
Locking Mushroom Pawl	Recept # - 845
Metal Pawl (on poly receptacle)	Recept # - 824
Closed Lid Configuration	Recept # - NC
With Auxiliary Switch	Recept # - 270*

Notes: * Not UL/CSA Listed

Inlet Options	Part #
With 2 Auxiliary/Pilot contacts	Inlet # - 972
Type 4X Watertightness	Inlet # - 4X
With no lockout hole	Inlet # - A155
For Auxiliary Switch*	Inlet # - NNF

Notes: * Order inlet with P+N+G configuration and receptacle with P+G configuration

DR30 Order Example:

To order 2 auxiliary/pilot contacts on an inlet and receptacle add -972 to the part numbers.

DR30 Inlet 3P+G = 31-18243-K04-972

DR30 Receptacle 3P+G = 31-14243-K04-972

Appropriate accessory part numbers must also be included on the order.



See pgs 197-206 for detailed information on these options

Installation Accessories

Handles



Not NEMA 3R

NPT	Poly Handle	Cable Range	Nylon Handle	Neoprene Handle	Poly Handle w/Clamp & Bushing
1/2"	1PH12	.20 - .83	FH111	-	-
3/4"	1PH34	.32 - .88	-	31-111	-
1"	1PH1	.750 - .875	-	-	1PM514
1 1/4"	1PH114	.875 - 1.000	-	-	1PM516
		1.000 - 1.125	-	-	1PM518
		1.125 - 1.250	-	-	1PM520
		1.250 - 1.375	-	-	1PM522

Notes: • Finger draw plates are recommended for easier connector closure on cord to cord assemblies.
• For available cord grips, see pgs 193-194.

Angles



Nylon 30° Angle	Metal 30° Angle	Metal Angle FS/FD Box 30°	Metal Straight Adapter
MP2	MA2	MAFS2	MS2

NPT Guidelines

Cable Range	NPT
.312 - .625	1/2"
.438 - .812	3/4"
.660 - 1.000	1"
.875 - 1.375	1 1/4"

NPT sizes are determined by the cable diameter and third party cord grip.

Junction Boxes

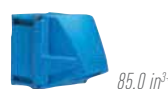
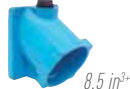
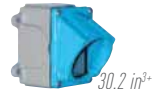

NPT	Metal Box	Metal Box with Nylon Angle	Poly* Conduit Entry	Poly 70°** Wall Box
1/2"	MB312	31-1A053-080-12	MC212	51-BA058
3/4"	MB334	31-1A053-080-34	MC234	51-BA058
1"	MB31	31-1A053-080-1	-	51-BA058
1 1/4"	MB3114	31-1A053-080-114	-	51-BA058

* For poly devices only
** 70° boxes are not drilled. Contact customer service if factory drilling is required.
• Interior volume with receptacle installed.

Miscellaneous Accessories



Finger Drawplates	Protective Cap	Padlockable Cap Poly	Inlet Spring-loaded Cap
FDP2	31-1A126	DS1PC	31-1A226

* Recommended for cord to cord assembly applications, for easier connector closure

Order Example

A typical order should include an inlet part number, a receptacle part number **AND** the matching handles, angles or other required accessories.



Male Inlet with Handle (Plug)
31-18243-K04 + FH111



Female Receptacle with Angle Adapter
31-14243-K04 + MP2

DR50



DR – 50A Standard Duty Plugs & Receptacles

Ratings

- Voltage**
600 VAC
- Current Interruption Capability**
For current interrupting up to 250 VAC
For Switch-Rated devices, see DS & DSN sections.
- Short Circuit Rating**
100kA
Testing was performed with RK1 current limiting fuses sized at least 100% of the devices ampacity rating.
- Environmental Ratings**
Type 3R, IP54/IP55*
* IP54 when the plug & receptacle are mated. IP55 on the receptacle alone when the lid is latched closed.
- Temperature Range**
Min -40°F/Max 140°F
See pg 220 for temps below -15°F.
- Wiring Capacity**
Min 14 AWG Max 6 AWG
Aux Contacts - Max 14 AWG
* Based on THHN wire sizes
- Listings**
UL, CSA, IEC, CE*
* Contact Customer Service

Receptacle (female)



Don't forget to add installation accessories to your order

Inlet (male)



Voltage	Polarity	Part # Poly
120/208V	3P+N+G	31-34237-K16
125V	1P+N+G	31-34175-K07
125/250V	2P+N+G	31-34176-K07
208V	2P+G	31-34232-K16
208V	3P+G	31-34233-K16
250V	2P+G	31-34172-K07
250V	3P+G	31-34173-K07
277V	1P+N+G	31-34245-K04
277/480V	3P+N+G	31-34247-K04
347/600V	3P+N+G	31-34187-K14
480V	2P+G	31-34242-K04
480V	3P+G	31-34243-K04
600V	2P+G	31-34182-K14
600V	3P+G	31-34183-K14

Voltage	Polarity	Part # Poly
120/208V	3P+N+G	31-38237-K16
125V	1P+N+G	31-38175-K07
125/250V	2P+N+G	31-38176-K07
208V	2P+G	31-38232-K16
208V	3P+G	31-38233-K16
250V	2P+G	31-38172-K07
250V	3P+G	31-38173-K07
277V	1P+N+G	31-38245-K04
277/480V	3P+N+G	31-38247-K04
347/600V	3P+N+G	31-38187-K14
480V	2P+G	31-38242-K04
480V	3P+G	31-38243-K04
600V	2P+G	31-38182-K14
600V	3P+G	31-38183-K14

Other voltage configurations are available – contact customer service at 800.433.7642.

Main Options



Auxiliary Contacts



Mushroom Pawl



Padlock Pawl



Closed Lid Configuration

Recommended for cord applications to keep lid tucked in to avoid damage.



See pgs 197-206 for detailed information on these options

Receptacle Options	Part #
With 2 Auxiliary/Pilot Contacts	Recept # - 972
With 3 Auxiliary/Pilot Contacts	Recept # - 973*
With 4 Auxiliary/Pilot Contacts	Recept # - 974*
Type 4X & closed lid configuration	Recept # - 4X
Mushroom Pawl	Recept # - 375
Padlock Pawl	Recept # - 843
Padlockable Mushroom Pawl	Recept # - 375-843
Locking Mushroom Pawl	Recept # - 845
Metal Pawl (on poly receptacle)	Recept # - 824
Closed Lid Configuration	Recept # - NC
With Auxiliary Switch	Recept # - 270*

Inlet Options	Part #
With 2 Auxiliary/Pilot Contacts	Inlet # - 972
With 3 Auxiliary/Pilot Contacts	Inlet # - 973*
With 4 Auxiliary/Pilot Contacts	Inlet # - 974*
Type 4X Watertightness	Inlet # - 4X
With No Lockout Hole	Inlet # - A155
For Auxiliary Switch*	Inlet # - NNF

Notes: * Order inlet with P+N+G configuration and receptacle with P+G configuration

DR50 Order Example:

To order 2 auxiliary/pilot contacts on an inlet and receptacle add -972 to the part numbers.

DR50 Inlet 3P+G = 31-38243-K04-972

DR50 Receptacle 3P+G = 31-34243-K04-972

Appropriate accessory part numbers must also be included on the order.

Notes: * Not UL/CSA Listed

Installation Accessories

Handles



Not NEMA 3R

Makes connector closures easier

NPT	Poly Handle	Cable Range	Nylon Handle	Neoprene Handle	Poly Handle w/Clamp & Bushing	Poly Handle w/built in Draw Grip
1/2"	3PH12	.32 - 1.25	-	-	-	FH311-473
3/4"	3PH34	.38 - 1.12	-	31-311	-	-
1"	3PH1	.39 - 1.18	FH311	-	-	-
1 1/4"	3PH114	.750 - .875	-	-	3PM514	-
		.875 - 1.000	-	-	3PM516	-
		1.000 - 1.125	-	-	3PM518	-
		1.125 - 1.250	-	-	3PM520	-
		1.250 - 1.375	-	-	3PM522	-

Notes: • For available cord grips, see pgs 193-194.
• For a guideline of NPT sizes based on cable ranges, see DR30 on pg 144.

Angles



Nylon 30° Angle	Metal 30° Angle	Metal 70° Angle	Metal Angle FS/FD Box 30°	Metal Straight Adapter
MP3	MA3	89-3A027	MAFS3	MS3

Junction Boxes

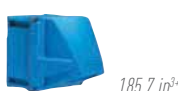

NPT	Metal Box	Metal Box with Nylon Angle	Poly* Conduit Entry	Poly 70°** Wall Box
1/2"	MB312	31-3A053-080-12	-	51-CA058
3/4"	MB334	31-3A053-080-34	MC334	51-CA058
1"	MB31	31-3A053-080-1	MC31	51-CA058
1 1/4"	MB3114	31-3A053-080-114	-	51-CA058

* For poly devices only
** 70° boxes are not drilled. Contact customer service if factory drilling is required.
• Interior volume with receptacle installed.

Miscellaneous Accessories



* Set of Two (2)



For Male Devices Only



For Male Devices Only



Finger Drawplates	Protective Cap	Padlockable Cap Poly	Inlet Spring-Loaded Cap
FDP3	31-3A126	DS3PC	31-3A226

Accessory Spotlight

Finger Drawplates



Finger drawplates are recommended for easier connector closure on cord to cord assemblies.

Order Example

A typical order should include an inlet part number, a receptacle part number **AND** the matching handles, angles or other required accessories.



Male Inlet with Handle (Plug)
31-38243-K04 + FH311



Female Receptacle with Angle Adapter
31-34243-K04 + MP3

DR100



DR - 100A Standard Duty Plugs & Receptacles

Ratings

- Voltage**
600 VAC
- Current Interruption Capability**
For current interrupting up to 600 VAC
For Switch-Rated devices, see DS & DSN sections.
- Short Circuit Rating**
100kA
Testing was performed with RK1 current limiting fuses sized at least 100% of the devices ampacity rating.
- Environmental Ratings**
Type 3R, IP54/IP55*
* IP54 when the plug & receptacle are mated. IP55 on the receptacle alone when the lid is latched closed.
- Temperature Range**
Min -40°F/Max 140°F
See pg 220 for temps below -15°F.
- Wiring Capacity**
Min 10 AWG Max 2 AWG
Aux Contacts - Max 14 AWG
* Based on THHN wire sizes
- Listings**
UL, CSA, IEC, CE*
* Contact Customer Service

Receptacle (female)



Don't forget to add installation accessories to your order

Inlet (male)



Voltage	Polarity	Part #	
		Poly	Metal
120/208V	3P+N+G	31-64237-K16	39-64237-K16
125V	1P+N+G	31-64175-K07	39-64175-K07
125/250V	2P+N+G	31-64176-K07	39-64176-K07
208V	2P+G	31-64232-K16	39-64232-K16
208V	3P+G	31-64233-K16	39-64233-K16
250V	2P+G	31-64172-K07	39-64172-K07
250V	3P+G	31-64173-K07	39-64173-K07
277V	1P+N+G	31-64245-K04	39-64245-K04
277/480V	3P+N+G	31-64247-K04	39-64247-K04
347/600V	3P+N+G	31-64187-K14	39-64187-K14
480V	2P+G	31-64242-K04	39-64242-K04
480V	3P+G	31-64243-K04	39-64243-K04
600V	2P+G	31-64182-K14	39-64182-K14
600V	3P+G	31-64183-K14	39-64183-K14

Voltage	Polarity	Part #	
		Poly	Metal
120/208V	3P+N+G	31-68237-K16	39-68237-K16
125V	1P+N+G	31-68175-K07	39-68175-K07
125/250V	2P+N+G	31-68176-K07	39-68176-K07
208V	2P+G	31-68232-K16	39-68232-K16
208V	3P+G	31-68233-K16	39-68233-K16
250V	2P+G	31-68172-K07	39-68172-K07
250V	3P+G	31-68173-K07	39-68173-K07
277V	1P+N+G	31-68245-K04	39-68245-K04
277/480V	3P+N+G	31-68247-K04	39-68247-K04
347/600V	3P+N+G	31-68187-K14	39-68187-K14
480V	2P+G	31-68242-K04	39-68242-K04
480V	3P+G	31-68243-K04	39-68243-K04
600V	2P+G	31-68182-K14	39-68182-K14
600V	3P+G	31-68183-K14	39-68183-K14

Other voltage configurations are available - contact customer service at 800.433.7642.

Main Options



Auxiliary Contacts



Mushroom Pawl



Padlock Pawl



Closed Lid Configuration

Recommended for cord applications to keep lid tucked in to avoid damage.



See pgs 197-206 for detailed information on these options

Receptacle Options

Part

With 2 Auxiliary/Pilot Contacts	Recept # - 972
With 3 Auxiliary/Pilot Contacts	Recept # - 263*
Type 4X & closed lid configuration	Recept # - 4X
Mushroom Pawl	Recept # - 375
Padlock Pawl	Recept # - 843
Padlockable Mushroom Pawl	Recept # -375-843
Locking Mushroom Pawl	Recept # - 845
Metal Pawl (on poly receptacle)	Recept # - 824
Closed Lid Configuration	Recept # - NC
With Auxiliary Switch	Recept # - 270**

Notes: + Not available for metal devices, not UL/CSA listed
++ Not UL/CSA listed

Inlet Options

Part

With 2 Auxiliary/Pilot Contacts	Inlet # - 972
With 3 Auxiliary/Pilot Contacts	Inlet # - 263*
Type 4X Watertightness	Inlet # - 4X
With No Lockout Hole	Inlet # - A155
For Auxiliary Switch*	Inlet # - NNF

Notes: * Order inlet with P+N+G configuration and receptacle with P+G configuration

DR100 Order Example:

To order 2 auxiliary/pilot contacts on an inlet and receptacle add -972 to the part numbers.

DR100 Inlet 3P+G = 31-68243-K04-972

DR100 Receptacle 3P+G = 31-64243-K04-972

Appropriate accessory part numbers must also be included on the order.

Installation Accessories

Unless indicated otherwise, accessories can be used with either poly or metal plugs and receptacles

Handles



Not NEMA 3R

Makes connector closures easier

NPT	Poly Handle	Metal* Handle	Cable Range	Nylon Handle	Neoprene Handle	Poly Handle w/Clamp & Bushing	Poly Handle w/built in Draw Grip
1/2"	6PH12	6H12	.50 - 1.25	-	31-611	-	-
3/4"	6PH34	6H34	.51 - 1.38	FH611	-	-	FH611-473
1"	6PH1	6H1	1.250 - 1.375	-	-	6PM622	-
1 1/4"	6PH114	6H114	1.438 - 1.562	-	-	6PM625	-
1 1/2"	6PH112	6H112	1.562 - 1.688	-	-	6PM627	-
			1.688 - 1.812	-	-	6PM629	-

- Notes:**
- For available cord grips, see pgs 193-194.
 - For a guideline of NPT sizes based on cable ranges, see DR250 on pgs 152.
 - * For metal devices only

Angles



Nylon 30° Angle	Metal 30° Angle	Metal 70° Angle	Metal Angle+ Oversized 30°	Metal Straight Adapter	Metal Lateral Angle 30°
MP6	MA6	89-6A027	MA660	MS6	MAB6

* Mounts on oversize box only. Order with MB10 box. See page 150.

Junction Boxes

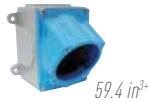

NPT	Metal Box	Metal Box with Nylon Angle	Metal Box with Metal Angle	Poly* Conduit Entry	Poly 70°** Wall Box
1/2"	-	-	-	MC612	51-DA058
3/4"	-	-	-	MC634	51-DA058
1"	MB61	31-6A053-080-1	39-6A053-080-1	MC61	51-DA058
1 1/4"	MB6114	31-6A053-080-114	39-6A053-080-114	MC6114	51-DA058
1 1/2"	MB6112	31-6A053-080-112	39-6A053-080-112	-	51-DA058
2"	MB62	31-6A053-080-2	39-6A053-080-2	-	51-DA058

- * For poly devices only ** 70° boxes are not drilled. Contact customer service if factory drilling is required.
 * Interior volume with receptacle installed.

Miscellaneous Accessories



* Set of Two (2)



For Male Devices Only



For Male Devices Only



Finger Drawplates	Protective Cap	Padlockable Cap Aluminum	Inlet Spring-Loaded Cap
FDP6	31-6A126	DS6MC	31-6A226

Specialty Products Spotlight

Poly 70° Wall Box



Entries and exits can be drilled in the field using pilot holes at top, bottom or sides. Large box size makes wiring easy. 70° angle reduces protrusion and minimizes impact risk.

Order Example

A typical order should include an inlet part number, a receptacle part number **AND** the matching handles, angles or other required accessories.



Male Inlet with Handle (Plug)
31-68243-K04 + FH611



Female Receptacle with Angle Adapter
31-64243-K04 + MP6

DR150



DR - 150A Standard Duty Plugs & Receptacles

Ratings

- Voltage**
600 VAC
- Current Interruption Capability**
For current interrupting up to 250 VAC
For Switch-Rated devices, see DS & DSN sections.
- Short Circuit Rating**
10kA
Testing was performed with RK1 current limiting fuses sized at least 100% of the devices ampacity rating.
- Environmental Ratings**
Type 4X, IP66+IP67 (Poly Only)
Type 3R, IP54/IP55*(Metal Only)
* IP54 when the plug & receptacle are mated. IP55 on the receptacle alone when the lid is latched closed.
- Temperature Range**
Min -40°F/Max 140°F
See pg 220 for temps below -15°F.
- Wiring Capacity**
Min 8 AWG Max 2/0 AWG
Aux Contacts - Max 14 AWG
* Based on THHN wire sizes
- Listings**
UL, CSA, IEC, CE*
* Contact Customer Service

Receptacle (female)



Inlet (male)

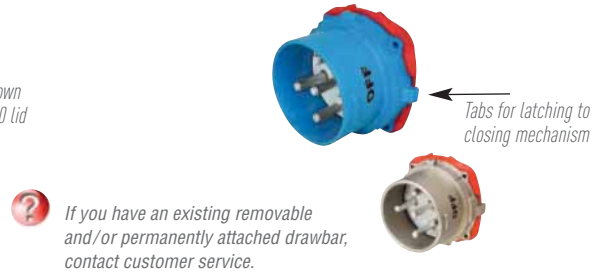

Voltage	Polarity	Part #	
		Poly	Metal
120/208V	3P+N+G	31-94237-K16	39-94237-K16
125V	1P+N+G	31-94175-K07	39-94175-K07
125/250V	2P+N+G	31-94176-K07	39-94176-K07
208V	2P+G	31-94232-K16	39-94232-K16
208V	3P+G	31-94233-K16	39-94233-K16
250V	2P+G	31-94172-K07	39-94172-K07
250V	3P+G	31-94173-K07	39-94173-K07
277V	1P+N+G	31-94245-K04	39-94245-K04
277/480V	3P+N+G	31-94247-K04	39-94247-K04
347/600V	3P+N+G	31-94187-K14	39-94187-K14
480V	2P+G	31-94242-K04	39-94242-K04
480V	3P+G	31-94243-K04	39-94243-K04
600V	2P+G	31-94182-K14	39-94182-K14
600V	3P+G	31-94183-K14	39-94183-K14

Voltage	Polarity	Part #	
		Poly	Metal
120/208V	3P+N+G	31-98237-K16	39-98237-K16
125V	1P+N+G	31-98175-K07	39-98175-K07
125/250V	2P+N+G	31-98176-K07	39-98176-K07
208V	2P+G	31-98232-K16	39-98232-K16
208V	3P+G	31-98233-K16	39-98233-K16
250V	2P+G	31-98172-K07	39-98172-K07
250V	3P+G	31-98173-K07	39-98173-K07
277V	1P+N+G	31-98245-K04	39-98245-K04
277/480V	3P+N+G	31-98247-K04	39-98247-K04
347/600V	3P+N+G	31-98187-K14	39-98187-K14
480V	2P+G	31-98242-K04	39-98242-K04
480V	3P+G	31-98243-K04	39-98243-K04
600V	2P+G	31-98182-K14	39-98182-K14
600V	3P+G	31-98183-K14	39-98183-K14

Other voltage configurations are available - contact customer service at 800.433.7642.

Main Options



Auxiliary Contacts



Mushroom Pawl



Padlock Pawl



Closed Lid Configuration
Recommended for cord applications to keep lid tucked in to avoid damage.



See pgs 197-206 for detailed information on these options

Receptacle Options

Part

With 2 Auxiliary/Pilot contacts	Recept # - 262
With 3 Auxiliary/Pilot contacts	Recept # - 263*
With 4 Auxiliary/Pilot contacts	Recept # - 264*
With 5 Auxiliary/Pilot contacts	Recept # - 975*
With 6 Auxiliary/Pilot contacts	Recept # - 976*
Type 4X & closed lid configuration	Recept # - 4X
Mushroom Pawl	Recept # - 375
Padlock Pawl	Recept # - 843
Padlockable Mushroom Pawl	Recept # - 375-843
Locking Mushroom Pawl	Recept # - 845
Metal Pawl (on poly receptacle)	Recept # - 824
180° Opening Lid	Recept # - 180**
Closed Lid configuration	Recept # - NC
With Auxiliary Switch	Recept # - 270***

- Notes:** * DR150 devices with 3 or more auxiliary/pilot contacts are not UL/CSA listed
** Required when mating to rigid mounted male inlet
*** Not UL/CSA listed

Inlet Options

Part

With 2 Auxiliary/Pilot contacts	Inlet # - 262
With 3 Auxiliary/Pilot contacts	Inlet # - 263*
With 4 Auxiliary/Pilot contacts	Inlet # - 264*
With 5 Auxiliary/Pilot contacts	Inlet # - 975*
With 6 Auxiliary/Pilot contacts	Inlet # - 976*
Type 4X Watertightness	Inlet # - 4X
With No Lockout Hole	Inlet # - A155
For Auxiliary Switch*	Inlet # - NNF

Notes: * Order inlet with P+N+G configuration and receptacle with P+G configuration

DR150 Order Example:

To order 2 auxiliary contacts on an inlet and receptacle add **-262** to the part numbers.

DR150 Inlet 3P+G = 31-98243-K04-**262**

DR150 Receptacle 3P+G = 31-94243-K04-**262**

Appropriate accessory part numbers must also be included on the order.

Installation Accessories

Unless indicated otherwise, accessories can be used with either poly or metal plugs and receptacles

Handles



IP 66/67



NPT	Poly Handle	Metal* Handle
3/4"	9PH34	9H34
1"	9PH1	9H1
1 1/4"	9PH114	9H114
1 1/2"	9PH112	9H112
2"	9PH2	9H2

Cable Range	Santoprene™ Handle	Poly Handle w/Clamp & Bushing
.70 - 1.00	65-9A013-D25	-
1.00 - 1.375	65-9A013-D35	-
1.250 - 1.375	-	9PM622
1.375 - 1.750	65-9A013-D45	-
1.438 - 1.562	-	9PM625
1.562 - 1.688	-	9PM627
1.688 - 1.812	-	9PM629

- Notes:**
- Finger draw plates are recommended for easier connector closure on cord to cord assemblies.
 - For available cord grips, see pgs 193-194.
 - * For metal devices only

- For a guideline of NPT sizes based on cable ranges, see DR250 on pg 152.

Angles



Nylon 30° Angle	Metal 30° Angle	Metal 70° Angle	Metal Angle+ Oversized 30°	Metal Straight Adapter
MP10	MA10	89-9A027	MA110	MS10

* Mounts on oversize box only. Order with MB220 box. See page 152.

Junction Boxes



108.7 in³

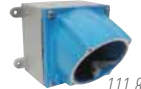

111.8 in³

NPT	Metal Box	Metal Box with Nylon Angle	Metal Box with Metal Angle
1 1/4"	MB10114	31-9A053-080-114	39-9A053-080-114
1 1/2"	MB10112	31-9A053-080-112	39-9A053-080-112
2"	MB102	31-9A053-080-2	39-9A053-080-2
2 1/2"	MB10212	31-9A053-080-212	39-9A053-080-212

* Interior volume with receptacle installed.

Miscellaneous Accessories



For Male Devices Only



For Male Devices Only



Protective Cap	Padlockable Cap Aluminum	Cord Grip with Mesh
31-9A126	DS9MC	see pgs 183-184

Order Example

A typical order should include an inlet part number, a receptacle part number **AND** the matching handles, angles or other required accessories.



Male Inlet with Handle (Plug)
39-98243-K04 + 65-9A013-D25



Female Receptacle with Angle Adapter
39-94243-K04 + MA10

Feature Spotlight – Easy Closing Mechanism

A new and simplified closing mechanism is now standard on the DS100 and DS200 plugs and receptacles. This compact mechanism enables easy connection of the plug to the receptacle.

- Notes:** After connection, the mechanism must be released to allow disconnection of the device.



The plug is partially inserted, clamps are placed around tab, ready to pull the plug into the receptacle.



The handles are pushed down, the plug is fully drawn into the receptacle.

DR250



DR - 250A Standard Duty Plugs & Receptacles

Ratings

- Voltage**
600 VAC
- Current Interruption Capability**
Not for current interrupting

For Switch-Rated devices, see DS & DSN sections.

- Short Circuit Rating**
10kA
Testing was performed with RK1 current limiting fuses sized at least 100% of the devices ampacity rating.

- Environmental Ratings**
Type 3R, IP54/IP55*

* IP54 when the plug & receptacle are mated. IP55 on the receptacle alone when the lid is latched closed.

- Temperature Range**
Min -40°F/Max 140°F
See pg 220 for temps below -15°F.

- Wiring Capacity**
Min 4 AWG Max 3/0+ AWG
Aux Contacts - Max 14 AWG

* Based on THHN wire sizes
+ 4/0 is available upon request by adding suffix "A06" to the inlet or receptacle.

- Listings**
UL, CSA, IEC, CE*

* Contact Customer Service

Receptacle (female)



Inlet (male)



Voltage	Polarity	Part # Metal
120/208V	3P+N+G	39-24237-K16
125V	1P+N+G	39-24035-K07
125/250V	2P+N+G	39-24036-K07
208V	2P+G	39-24232-K16
208V	3P+G	39-24233-K16
250V	2P+G	39-24032-K07
250V	3P+G	39-24033-K07
277V	1P+N+G	39-24245-K04
277/480V	3P+N+G	39-24247-K04
347/600V	3P+N+G	39-24027-K14
480V	2P+G	39-24242-K04
480V	3P+G	39-24243-K04
600V	2P+G	39-24022-K14
600V	3P+G	39-24023-K14

Voltage	Polarity	Part # Metal
120/208V	3P+N+G	39-28237-K16
125V	1P+N+G	39-28035-K07
125/250V	2P+N+G	39-28036-K07
208V	2P+G	39-28232-K16
208V	3P+G	39-28233-K16
250V	2P+G	39-28032-K07
250V	3P+G	39-28033-K07
277V	1P+N+G	39-28245-K04
277/480V	3P+N+G	39-28247-K04
347/600V	3P+N+G	39-28027-K14
480V	2P+G	39-28242-K04
480V	3P+G	39-28243-K04
600V	2P+G	39-28022-K14
600V	3P+G	39-28023-K14

Other voltage configurations are available - contact customer service at 800.433.7642.

Main Options



Auxiliary Contacts



Mushroom Pawl



Padlock Pawl



Closed Lid Configuration
Recommended for cord applications to keep lid tucked in to avoid damage.

See pgs 197-206 for detailed information on these options

Receptacle Options	Part #
With 2 Auxiliary/Pilot Contacts	Recept # - 172
With 3 Auxiliary/Pilot Contacts	Recept # - 173*
With 4 Auxiliary/Pilot Contacts	Recept # - 174*
With 5 Auxiliary/Pilot Contacts	Recept # - 175*
Type 4X & closed lid configuration	Recept # - 4X
Mushroom Pawl	Recept # - 375
Padlock Pawl	Recept # - 843
Padlockable Mushroom Pawl	Recept # - 375-843
Locking Mushroom Pawl	Recept # - 845
Metal Pawl (on poly receptacle)	Recept # - 824
180° Opening Lid	Recept # - 180**
Closed Lid Configuration	Recept # - NC
With Auxiliary Switch	Recept # - 270***

Notes: * DR250 devices with 3 or more auxiliary/pilot contacts are not UL/CSA listed
** Required when mating to rigid mounted male inlet
*** Not UL/CSA listed

Inlet Options	Part #
With 2 Auxiliary/Pilot Contacts	Inlet # - 172
With 3 Auxiliary/Pilot Contacts	Inlet # - 173*
With 4 Auxiliary/Pilot Contacts	Inlet # - 174*
With 5 Auxiliary/Pilot Contacts	Inlet # - 175*
Type 4X Watertightness	Inlet # - 4X
With No Lockout Hole	Inlet # - A155
For Auxiliary Switch*	Inlet # - NNF

Notes: * Order inlet with P+N+G configuration and receptacle with P+G configuration

DR250 Order Example:

To order 2 auxiliary/pilot contacts on an inlet and receptacle add -172 to the part numbers.

DR250 Inlet 3P+G = 39-28243-K04-172

DR250 Receptacle 3P+G = 39-24243-K04-172

Appropriate accessory part numbers must also be included on the order.

Installation Accessories

Handles



IP 66/67

NPT	Poly Handle	Metal Handle
1"	-	2H1
1 1/4"	-	2H114
1 1/2"	2PH112	2H112
2"	2PH2	2H2
2 1/2"	2PH212	2H212
3"	-	2H3

Cable Range	Santoprene™ Handle
1.00 - 1.375	35-2A013-D35
1.375 - 1.750	35-2A013-D45
1.750 - 1.900	35-2A013-D49

NPT Guidelines

Cable Range	NPT
.312 - .625	1/2"
.438 - .812	3/4"
.660 - 1.000	1"
.875 - 1.375	1 1/4"
.890 - 1.812	1 1/2"
1.190 - 2.438	2"
2.062 - 2.438	2 1/2"

NPT sizes are determined by the cable diameter and third party cord grip.

- Notes:**
- Finger draw plates are recommended for easier connector closure on cord to cord assemblies.
 - For available cord grips, see pgs 193-194.

Angles



Metal 60° Angle	Metal Angle+ Oversized 45°	Metal Straight Adapter
MA20	MA220	MS20

* Mounts on oversize box only.

Junction Boxes



248.4 in³

	Metal Box	Metal Box for Metal Angle Oversized	Metal Box with Metal Angle
1 1/2"	MB20112	-	39-2A053-080-112
2"	MB202	-	39-2A053-080-2
2 1/2"	MB20212	MB22212	39-2A053-080-212

* Interior volume with receptacle installed.

Miscellaneous Accessories



For Male Devices Only



For Male Devices Only



Protective Cap	Padlockable Cap Aluminum	Cord Grip with Mesh
31-2A126	DS2MC	see pgs 193-194

Feature Spotlight – Easy Closing Mechanism

A new and simplified closing mechanism is now standard on the DS100 and DS200 plugs and receptacles. This compact mechanism enables easy connection of the plug to the receptacle.

- Notes:** After connection, the mechanism must be released to allow disconnection of the device.



The plug is partially inserted, clamps are placed around tab, ready to pull the plug into the receptacle.



The handles are pushed down, the plug is fully drawn into the receptacle.

Order Example

A typical order should include an inlet part number, a receptacle part number **AND** the matching handles, angles or other required accessories.



Male Inlet with Handle (Plug)
39-28247-K04 + 35-2A013-D35



Female Receptacle with Angle Adapter
39-24247-K04 + MA20



Spare Parts

Male Configuration

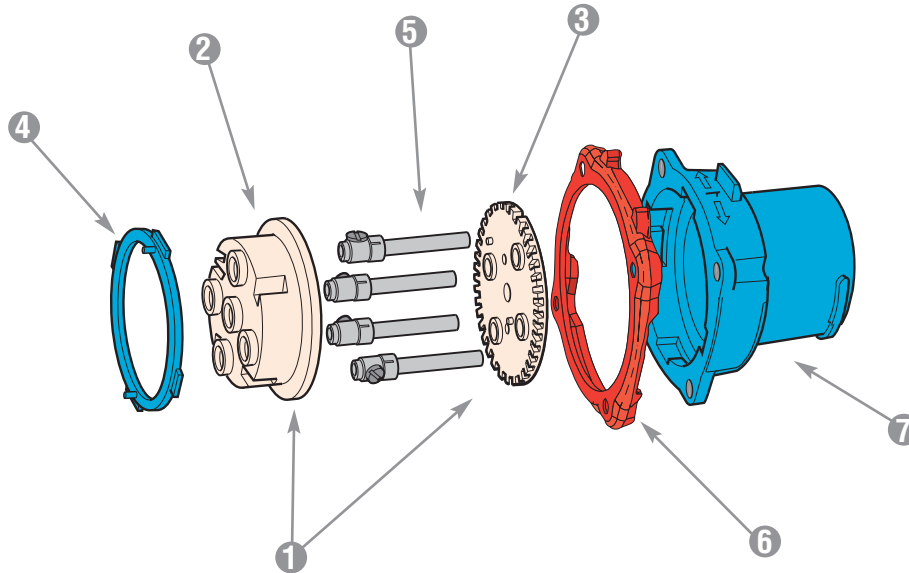

	DR30 POLY	DR50 POLY	DR100 POLY	DR100 METAL	DR150 POLY	DR150 METAL	DR250 METAL	
1 = Plug Interior	31-1A010*	31-3A010*	31-6A010*	31-6A010*	31-9A010*	39-9A010*	39-2A010*	
1 = Plug Interior with Ground Contacts	-	-	-	39-6A110*	-	39-9A110*	39-2A110*	
2 = Interior Bottom	31-1A010-B	31-3A010-B	31-6A010-B	31-6A010-B	31-9A010-B	39-9A010-B	39-2A010-B	
3 = Interior Top	31-1A010-T*	31-3A010-T*	31-6A010-T*	31-6A010-T*	31-9A010-T*	39-9A010-T*	39-2A010-T*	
4 = Polyester Locking Ring	31-1A583	31-3A583	31-6A583	-31-9A583	-	-		
4 = Metal Locking Ring	-	-	-	39-6A583	-	39-9A583	39-2A583	
5 = Plug Phase Contact (If no aux. contacts)	31-1A011-380	31-3A011-380	31-6A011	31-6A011	39-9A011	39-9A011	39-2A011	
5 = Plug Phase Contact (If plug has aux. contacts)	31-1A011	31-3A011-380	31-6A011	31-6A011	39-9A011	39-9A011	39-2A011	
5 = Plug Ground Contact	31-1A019	31-3A019	31-6A019	39-6A019	31-9A019	39-9A019	39-2A019	
6 = Color-Coded Voltage Gasket	<div style="display: flex; align-items: center;"> <div style="width: 15px; height: 10px; border-radius: 5px; background-color: #0056b3; margin-right: 5px;"></div> 208V </div> <div style="display: flex; align-items: center;"> <div style="width: 15px; height: 10px; border-radius: 5px; background-color: #ff9900; margin-right: 5px;"></div> 250V </div> <div style="display: flex; align-items: center;"> <div style="width: 15px; height: 10px; border-radius: 5px; background-color: #cc0000; margin-right: 5px;"></div> 480V </div> <div style="display: flex; align-items: center;"> <div style="width: 15px; height: 10px; border-radius: 5px; background-color: #333333; margin-right: 5px;"></div> 600V </div> <div style="display: flex; align-items: center;"> <div style="width: 15px; height: 10px; border-radius: 5px; background-color: #ff9900; margin-right: 5px;"></div> 125V </div>	31-1AB26	31-3AB26	31-6AB26	31-6AB26	31-9AB26	31-9AB26	39-2AB26
	31-1AC26	31-3AC26	31-6AC26	31-6AC26	31-9AC26	31-9AC26	39-2AC26	
	31-1AR26	31-3AR26	31-6AR26	31-6AR26	31-9AR26	31-9AR26	39-2AR26	
	31-1AN26	31-3AN26	31-6AN26	31-6AN26	31-9AN26	31-9AN26	39-2AN26	
	31-1AC26	31-3AC26	31-6AC26	31-6AC26	31-9AC26	31-9AC26	39-2AC26	
7 = Plug Polyester Casing	31-1A014**	31-3A014**	31-6A014**	-	31-9A014**	-	-	
7 = Plug Metal Casing	-	-	-	39-6A014**	-	39-9A014**	39-2A014**	
Ground Ring (Not Shown)	-	-	-	39-6A523	-	39-9A523P	39-2A523	

* Voltage and phasing positions must be specified (5th, 6th & 7th digit of Part #) to duplicate your shutter and alignment notches.

** For appropriate labeling on a device, please specify voltage, phasing, and product type

Spare Parts

Female Configuration

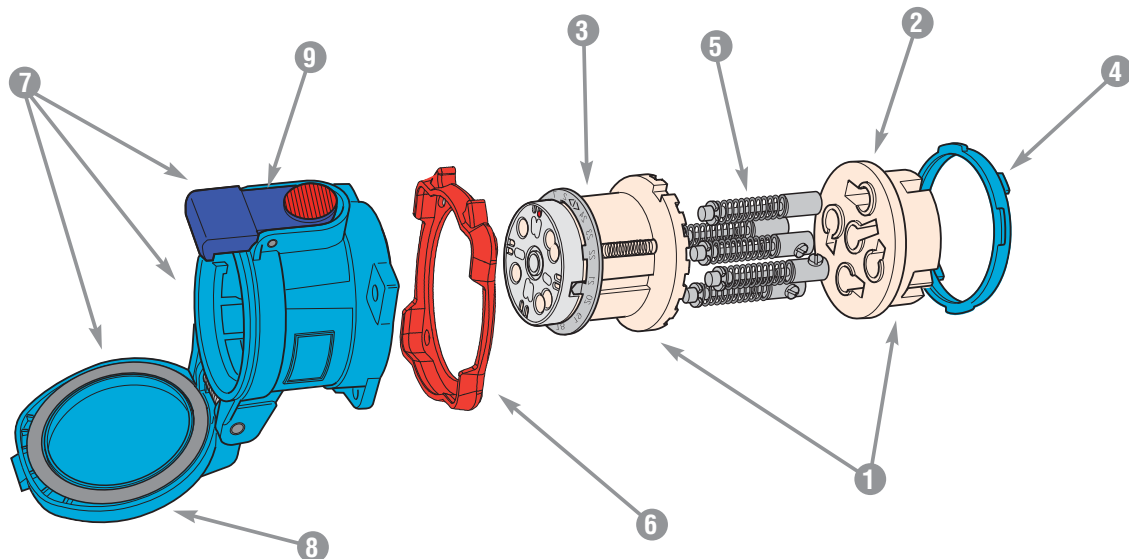

	DR30 POLY	DR50 POLY	DR100 POLY	DR100 METAL	DR150 POLY	DR150 METAL	DR2530 METAL	
1 = Receptacle Interior	31-1A020*	31-3A020*	31-6A020*	31-6A020*	31-9A020*	39-9A020*	39-2A020*	
1 = Receptacle Interior with Ground Contacts	-	-	-	39-6A220*	-	39-9A220*	39-2A220*	
2 = Interior Bottom	31-1A020-B	31-3A020-B	31-6A020-B	31-6A020-B	31-9A020-B	39-9A020-B	39-2A020-B	
3 = Interior Top	31-1A020-T*	31-3A020-T*	31-6A020-T*	31-6A020-T*	31-9A020-T*	39-9A020-T*	39-2A020-T*	
4 = Polyester Locking Ring	31-1A583	31-3A583	31-6A583	-31-9A583	-	-	-	
4 = Metal Locking Ring	-	-	-	39-6A583	-	39-9A583	39-2A583	
5 = Recept Phase Contact (If no aux. contacts)	31-1A021-380	31-3A021-380	31-6A021	31-6A021	39-9A021	39-9A021	39-2A021	
5 = Recept Phase Contact (If plug has aux. contacts)	31-1A021	31-3A021-380	31-6A021	31-6A021	39-9A021	39-9A021	39-2A021	
5 = Recept Ground Contact	31-1A029	31-3A029	31-6A029	39-6A029	31-9A029	39-9A029	39-2A029	
6 = Color-Coded Voltage Gasket	<div style="background-color: #0056b3; color: white; padding: 2px; border-radius: 5px;">208V</div> <div style="background-color: #ff9900; color: white; padding: 2px; border-radius: 5px;">250V</div> <div style="background-color: #ff0000; color: white; padding: 2px; border-radius: 5px;">480V</div> <div style="background-color: #000000; color: white; padding: 2px; border-radius: 5px;">600V</div> <div style="background-color: #ff9900; color: white; padding: 2px; border-radius: 5px;">125V</div>	31-1AB26	31-3AB26	31-6AB26	31-6AB26	31-9AB26	31-9AB26	39-2AB26
		31-1AC26	31-3AC26	31-6AC26	31-6AC26	31-9AC26	31-9AC26	39-2AC26
		31-1AR26	31-3AR26	31-6AR26	31-6AR26	31-9AR26	31-9AR26	39-2AR26
		31-1AN26	31-3AN26	31-6AN26	31-6AN26	31-9AN26	31-9AN26	39-2AN26
		31-1AC26	31-3AC26	31-6AC26	31-6AC26	31-9AC26	31-9AC26	39-2AC26
7 = Receptacle Polyester Casing with Lid	31-1A024**	31-3A024**	31-6A024**	-	31-9A024**	-	-	
7 = Receptacle Metal Casing with Lid	-	-	-	39-6A024**	-	39-9A024**	39-2A024**	
Ground Ring (Not Shown)	-	-	-	39-6A523	-	39-9A523	39-2A523	
8 = Lid Replacement Kit Polyester	31-1A125	31-3A125	31-6A125	-	31-9A125	-	-	
8 = Lid Replacement Kit Metal	-	-	-	39-6A925	-	39-9A925	39-2A925	
9 = Pawl Replacement Kit Polyester	31-1A824	31-3A824	31-6A824	-	31-9A824	-	-	
9 = Pawl Replacement Kit Metal	-	-	-	39-6A824	-	39-9A824	39-2A824	

* Voltage and phasing positions must be specified (5th, 6th & 7th digit of Part #) to duplicate your shutter and alignment notches.

** For appropriate labeling on a device, please specify voltage, phasing, and product type

For replacement parts contact customer service at 800.433.7642



Dimensions

Inlet – Provided in inches

Dimensions are for reference only and may change depending on accessories used. For precise dimensions contact Meltric Engineering.

Plug

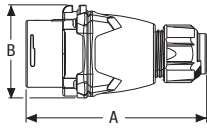

PRODUCT	A	B
DR30	5.72	2.79
DR50	6.15	3.23
DR100/DR7	6.70	3.77
DR150	8.09	4.79
DR250	10.30	5.67

30° inclined inlet/angle with connector

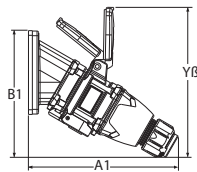

PRODUCT	A1	B1	YB
DR30	7.50	6.59	7.60
DR50	8.05	6.89	8.44
DR100/DR7	7.90	5.35	9.09
DR150	12.34	10.00	11.34
DR250 60°	11.08	16.81	

30° inclined inlet/angle/ junction box with connector

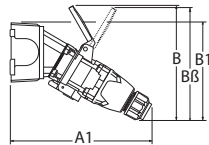

PRODUCT	A1	B	B1	Bβ
DR30	9.23	7.56	6.74	6.85
DR50	10.30	7.51	7.02	8.46
DR100/DR7	11.87	9.09	8.19	10.00
DR150	16.06	12.24	10.00	
DR250 60°	15.76	16.81	13.66	

70° inclined inlet/wall box with connector

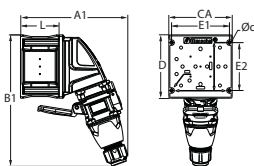

PRODUCT	A1	B1	CA	D	E1	E2	L	Ød
DR30	8.42	10.50	5.04	5.04	4.57	3.78	3.07	0.26
DR50	9.53	12.32	6.69	6.69	6.14	5.43	3.07	0.26
DR100/DR7	9.84	13.31	6.69	6.69	6.14	5.43	3.07	0.26

Inlet

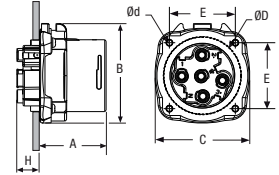

PRODUCT	A	B	C	E	H	Ød	ØD
DR30	1.86	2.76	2.57	1.89	0.72	0.20	2.07
DR50	2.07	3.23	3.07	2.17	0.86	0.20	2.48
DR100/DR7	2.38	3.77	3.60	2.60	1.04	0.24	3.15
DR150	2.96	4.79	4.50	3.19	1.09	0.24	3.81
DR250	3.20	5.67	5.79	3.86	1.46	0.26	4.57

30° inlet/angle

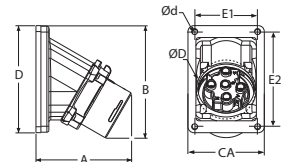

PRODUCT	A	B	CA	D	E1	E2	Ød	ØD
DR30	3.54	4.56	3.00	4.21	2.48	3.74	0.22	2.25
DR50	3.93	4.80	3.00	4.21	2.48	3.74	0.22	2.36
DR100/DR7	4.42	5.84	4.02	5.35	3.43	4.80	0.26	2.76
DR150	6.11	6.50	5.57	5.57	4.83	4.83	0.28	4.72
DR250 60°	6.90	9.10	7.20	7.20	6.50	6.50	0.25	4.80

inlet/angle/ metal junction box

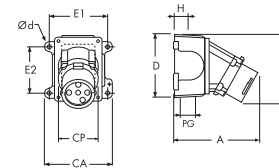

PRODUCT	A	B	CA	CP	D	E1	E2	H	PG	Ød
DR30	5.89	4.69	4.40	2.48	4.50	3.75	2.75	1.10	1.00	0.27
DR50	6.26	4.91	4.40	2.48	4.50	3.75	2.75	1.10	1.00	0.27
DR100/DR7	7.50	6.00	5.75	3.44	5.84	5.00	3.82	1.50	1.50	0.33
DR150	9.81	6.50	7.50	4.83	5.50	6.75	4.24	1.84	2.00	0.31
DR250 60°	11.60	8.96	9.26	6.50	7.25	8.13	6.38	1.92	2.50	0.31

70° inlet/wall box

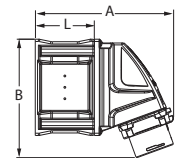

PRODUCT	A	B	L
DR30	7.17	6.14	3.07
DR50	8.19	7.70	3.07
DR100/DR7	8.31	8.31	3.07

Dimensions

Receptacle – Provided in inches

Dimensions are for reference only and may change depending on accessories used. For precise dimensions contact Meltric Engineering.

connector

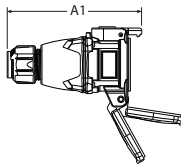

PRODUCT	A1
DR30	6.38
DR50	6.93
DR100/DR7	7.75
DR150	9.75
DR250	10.87

receptacle with plug

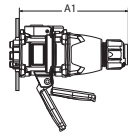

PRODUCT	A1
DR30	6.67
DR50	7.05
DR100/DR7	8.05
DR150	10.29
DR250	12.06

receptacle

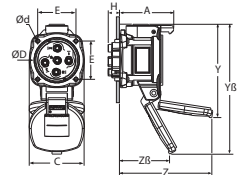

PRODUCT	A	C	E	H	Y	Yβ	Z	Zβ	Ød	ØD
DR30	2.60	2.61	1.89	0.70	4.14	6.32	4.63	1.93	0.20	2.25
DR50	2.87	3.04	2.17	0.86	4.48	7.16	4.84	2.33	0.20	2.68
DR100/DR7	3.37	3.59	2.60	1.16	6.57	8.46	5.91	2.76	0.22	3.21
DR150	4.60	4.46	3.19	1.09	8.03	10.94	8.70	3.46	0.24	3.81
DR250	4.75	5.16	3.86	1.46	7.99	11.54	8.62	2.48	0.26	4.57

30° inclined receptacle/angle with plug

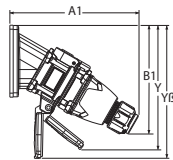

PRODUCT	A1	B1	Y	Yβ
DR30	7.50	6.59	6.86	7.87
DR50	8.05	6.89	8.87	8.44
DR100/DR7	7.90	8.07	10.00	10.16
DR150	12.34	10.00	12.05	12.05
DR250 60°	11.08	16.67	15.03	

30° receptacle/angle

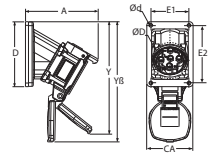

PRODUCT	A	D	E1	E2	Y	Yβ	Ød	ØD
DR30	4.51	4.25	2.48	3.74	6.84	7.87	0.22	2.25
DR50	4.91	4.25	2.48	3.74	8.79	8.43	0.22	2.25
DR100/DR7	5.62	5.35	3.43	4.80	9.11	10.32	0.26	2.76
DR150	7.89	5.57	4.83	4.83	12.05	12.05	0.28	4.72
DR250 60°	8.43	7.20	6.50	6.50	15.08		0.25	4.80

30° inclined receptacle/angle/junction box with plug

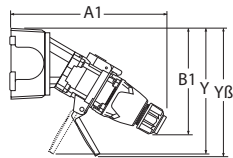

PRODUCT	A1	B1	Y	Yβ
DR30	9.84	6.73	7.29	7.94
DR50	10.30	7.02	8.39	8.39
DR100/DR7	11.87	8.19	10.45	9.24
DR150	16.06	9.53	11.77	
DR250 60°	15.76	13.66	11.54	

receptacle/angle/metal junction box

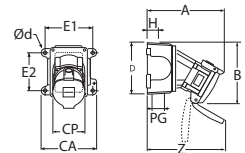

PRODUCT	A	B	CA	CP	D	E1	E2	H	PG	Z	Ød
DR30	6.86	5.37	4.40	2.61	4.50	3.75	2.75	1.10	1.00	6.77	0.27
DR50	7.25	5.62	4.40	2.70	4.50	3.75	2.75	1.10	1.00	6.77	0.27
DR100/DR7	8.75	7.00	5.75	3.44	5.84	5.00	3.82	1.50	1.50	7.56	0.33
DR150	11.50	7.80	7.50	4.83	5.50	6.75	4.24	1.84	2.00	10.28	0.33
DR250 60°	13.11	9.77	9.25	6.50	7.25	8.13	6.38	1.92	2.50	11.89	0.33

70° inclined receptacle/wall box with plug

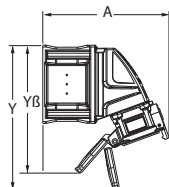

PRODUCT	A	Y	Yβ
DR30	8.03	9.25	9.24
DR50	9.06	9.57	11.30
DR100/DR7	9.33	12.56	10.59

70° receptacle/wall box

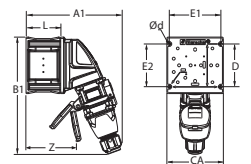

PRODUCT	A1	B1	CA	D	E1	E2	L	Z	Ød
DR30	8.41	10.50	5.00	5.00	4.57	3.78	3.07	4.91	0.26
DR50	9.53	12.32	6.69	6.69	6.14	5.43	3.07	4.91	0.26
DR100/DR7	9.76	13.03	6.69	6.69	6.22	5.47	3.07	4.09	0.26

PN

Features and Ratings	p. 158
PN20/30	p. 159
PN20/30 High Temp	p. 161
Spare parts	p. 163
Dimensions	p. 165



Compact plugs and receptacles – standard or high temperature rated

PN Series plugs and receptacles offer superior safety, durability and electrical performance relative to competitive devices. They feature Meltric's spring-loaded, silver-nickel butt contacts in a compact design that is ideal for use on small equipment and other applications where space is limited. PN devices are available with up to IP66-IP67 environmental protection. Available casing materials include glass fiber reinforced polyester (PBT), epoxy coated Zamak and aluminum. The aluminum cased models are designed to withstand high temperatures and can be used in applications up to 365° F.

Main Advantages

- ▶ Compact yet durable device
- ▶ Spring loaded silver-nickel contacts
- ▶ Spring assisted terminals are unaffected by vibrations and thermal cycling

Product Features

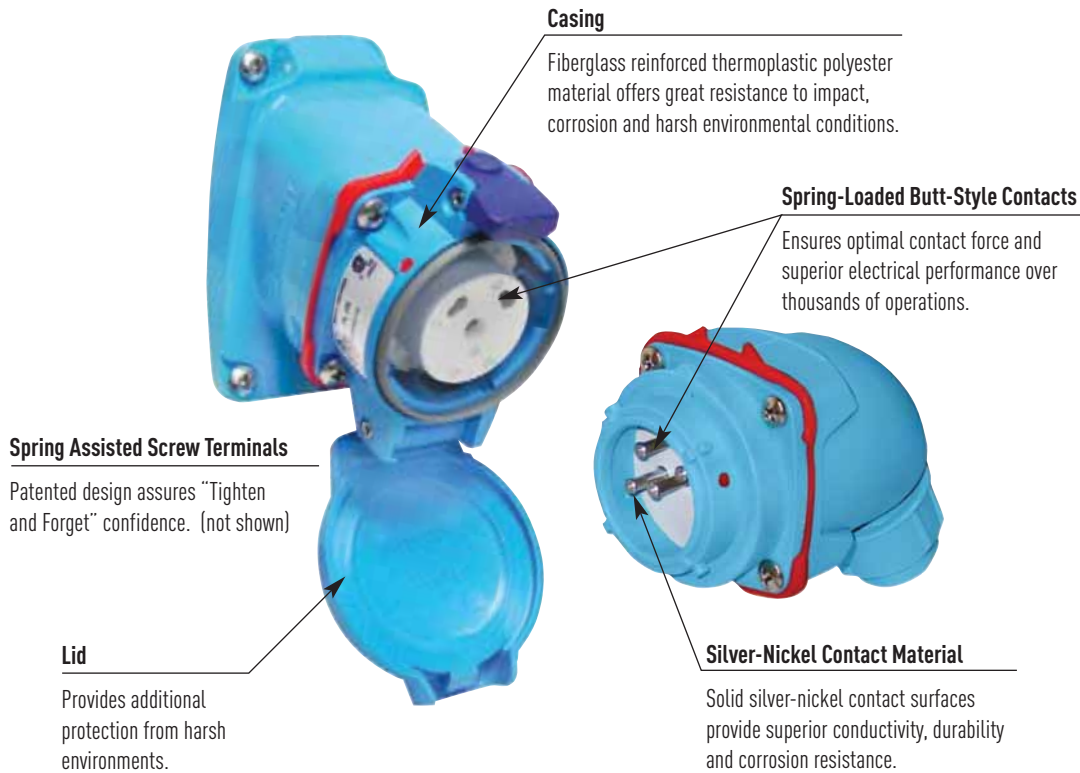

Operating Instructions



To break the circuit and remove the plug, press the pawl, apply inward force and rotate the plug clockwise.



The plug can be safely withdrawn from the receptacle. The plug contacts remain shrouded until after the circuit is broken.



To reconnect, align the red dots on the plug and receptacle bodies, insert plug into the receptacle, apply insertion force and rotate the plug 20° counterclockwise.

General Ratings

Amperage	20 to 30A
Voltage	600 VAC Max
Frequency	50-400 Hz
Environmental	IP66+IP67
Temperature	min -40°F/max 140°F (365° high temp model)

Current Interruption Listings

Model	Current interruption capabilities
PN20	For current interrupting
PN30	Not for current interrupting

Highlighted Feature

PN Contact

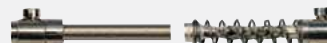

PN devices feature silver-nickel, spring-loaded, butt-style contacts for superior durability and electrical performance.

Listings

Category	UL	CSA	IEC
Plugs and Receptacles	UL 1682*	C22.2 No. 182.1*	60309-1

* PN 20A devices are UL and CSA listed for current interrupting, PN 30A devices are UL listed, non-current interrupting
PNHT devices are not UL/CSA listed

PN20



Compact – 20A or 30A or 15A (600V) Standard Duty Plugs & Receptacles

Receptacle (female)

Inlet (male)



Don't forget to add installation accessories to your order

Notes: • The same male inlet is used for IP66+IP67 or IP55 watertight ratings.

Ratings

- **Voltage**
600 VAC
- **Current Interruption Capability**
20A Current Interrupting (up to 480 VAC)
15A Current Interrupting (600 VAC)
30A Non-Current Interrupting*
* must use -30A suffix - see below
- **Environmental Ratings**
IP66+IP67*, IP54/IP55**
* IP66+IP67 provides advanced watertightness for washdown duty applications.
** IP55 provides rainproof watertightness with ease of connection convenience.
- **Temperature Range**
Min -40°F / Max 140°F
See pg 220 for temps below -15°F.
- **Wiring Capacity**
Min 14 AWG Max 8 AWG
- **Listings**
UL, CSA, IEC, CE*
* Contact Customer Service

IP66+IP67 or IP55

Voltage	Polarity	Part #		Part #		Voltage	Polarity	Part #	
		Poly	Metal	Poly	Metal			Poly	Metal
120/208V	3P+N+G	01-N4167	09-N4167	01-S4167	09-S4167	120/208V	3P+N+G	01-N8167	09-N8167
125V	1P+N+G	01-N4075	09-N4075	01-S4075	09-S4075	125V	1P+N+G	01-N8075	09-N8075
125/250V	2P+N+G	01-N4076	09-N4076	01-S4076	09-S4076	125/250V	2P+N+G	01-N8076	09-N8076
208V	2P+G	01-N4162	09-N4162	01-S4162	09-S4162	208V	2P+G	01-N8162	09-N8162
208V	3P+G	01-N4163	09-N4163	01-S4163	09-S4163	208V	3P+G	01-N8163	09-N8163
250V	2P+G	01-N4072	09-N4072	01-S4072	09-S4072	250V	2P+G	01-N8072	09-N8072
250V	3P+G	01-N4073	09-N4073	01-S4073	09-S4073	250V	3P+G	01-N8073	09-N8073
277V	1P+N+G	01-N4045	09-N4045	01-S4045	09-S4045	277V	1P+N+G	01-N8045	09-N8045
277/480V	3P+N+G	01-N4047	09-N4047	01-S4047	09-S4047	277/480V	3P+N+G	01-N8047	09-N8047
480V	2P+G	01-N4042	09-N4042	01-S4042	09-S4042	347/600V	2P+G	01-N8042	09-N8042
480V	3P+G	01-N4043	09-N4043	01-S4043	09-S4043	480V	3P+G	01-N8043	09-N8043
347/600V	3P+N+G	01-N4147	09-N4147	01-S4147	09-S4147	480V	3P+N+G	01-N8147	09-N8147
600V	2P+G	01-N4142	09-N4142	01-S4142	09-S4142	600V	2P+G	01-N8142	09-N8142
600V	3P+G	01-N4143	09-N4143	01-S4143	09-S4143	600V	3P+G	01-N8143	09-N8143

Notes: • 600V devices are rated for current interrupting up to 15A only

Other voltage configurations are available – contact customer service at 800.433.7642.

Main Options



Receptacle Options	Part #
Reverse Interiors	Recept # - 001
With Flush Mount	Recept # - 142
Locking Pawl	Recept # - 824-300
30A Rating	Recept # - 30A

Inlet Options	Part #
Reverse Interiors	Inlet # - 001
30A Rating	Inlet # - 30A

Example:

To order a device with a reverse interior add **-001** to the inlet and receptacle part numbers.

PN20 Inlet 3P+G = 01-N4043-**001**

PN20 Receptacle 3P+G = 01-N8043-**001**

Appropriate accessory part numbers must also be included on the order.

Installation Accessories

Unless indicated otherwise, accessories can be used with either poly or metal plugs and receptacles

Handles



NPT	Poly Handle Threaded Opening	Metal Handle* Threaded Opening	90° Nylon Handle Threaded Opening
1/2"	01-NA013-12	H091U12	04-2A090-5-12
3/4"	01-NA013-34	H091U34	04-2A090-5-34
1"	01-NA013-1	H091U1	04-2A090-5-10

Cable Range	Straight Poly Handle w/Clamp & Bushing	Angled Poly Handle w/Clamp & Bushing
.35 - .69	01-NA013	01-NA313

Notes: • For available cord grips, see pgs 193-194.
* For metal devices only

NPT Guidelines

Cable Range	NPT	Cable Range	NPT
.312 - .625	1/2"	.660 - 1.000	1"
.438 - .812	3/4"	.875 - 1.375	1 1/4"

NPT sizes are determined by the cable diameter and third party cord grip.

Junction Boxes



NPT	Metal Box	Metal Box With Nylon Angle	Metal Box With Metal Angle	Poly Conduit Entry	Poly Straight Wall Box	Metal Straight Wall Box	Poly 70°* Wall Box
1/2"	MB312	01-NA053-080-12	09-NA053-080-12	01-NA023-12	01-NA025-12	09-NA025-12	51-AA058
3/4"	MB334	01-NA053-080-34	09-NA053-080-34	01-NA023-34	01-NA025-34	09-NA025-34	51-AA058
1"	MB331	01-NA053-080-1	09-NA053-080-1	-	-	-	51-AA058
1 1/4"	MB3114	01-NA053-080-114	09-NA053-080-114	-	-	-	51-AA058

Notes: * 70° boxes are not drilled. Contact customer service if factory drilling is required.

Angles



Nylon 30° Angle	Nylon 30° Angle for MB Box	Metal 45° Angle	Metal Straight Adapter 90°	Nylon 30° Angle/Adapter Plate for FS Box
01-NA027	01-NA027-601	09-NA027	MSPN	MAFS1*

* Includes angle, adapter plate and gaskets for FS box mounting

Miscellaneous Accessories



For Male Devices Only



Protective Cap	Flush Mount
01-NA126	01-2A142

Order Example

A typical order should include an inlet part number, a receptacle part number **AND** the matching handles, angles or other required accessories.



Male Inlet with Handle (Plug)
01-N8043 + 01-NA313



Female Receptacle with Angle Adapter
01-N4043 + 01-NA027

PNHT



High Temperature – 20 - 30A

Standard Duty Plugs & Receptacles

Receptacle (female)

Inlet (male)



Don't forget to add installation accessories to your order

Ratings

- **Voltage**
600 VAC, 250 VDC
 - **Current Interruption Capability**
PNHT20A Current Interrupting (up to 480 VAC)
PNHT15A Current Interrupting (600 VAC, 250 VDC)
PNHT30A Non-Current Interrupting (600 VAC)
 - **Environmental Ratings**
IP44
 - **Temperature Range**
Min -40°F / Max 365°F
 - **Wiring Capacity**
Min 14 AWG Max 8 AWG
 - **Listings**
IEC, CE*
- * Contact Customer Service

Voltage	Polarity	Part #	
		20A	30A
250V	1P+N+G	09-24015-185	09-34015-185
250V	2P+G	09-24012-185	09-34012-185
250V	2P+N+G	09-24016-185	09-34016-185
250V	3P+G	09-24013-185	09-34013-185
250V	3P+N+G	09-24017-185	09-34017-185
600V	1P+N+G	09-24035-185	09-34035-185
600V	2P+G	09-24032-185	09-34032-185
600V	3P+G	09-24033-185	09-34033-185
600V	3P+N+G	09-24037-185	09-34037-185

Voltage	Polarity	Part #	
		20A	30A
250V	1P+N+G	09-28015-185	09-38015-185
250V	2P+G	09-28012-185	09-38012-185
250V	2P+N+G	09-28016-185	09-38016-185
250V	3P+G	09-28013-185	09-38013-185
250V	3P+N+G	09-28017-185	09-38017-185
600V	1P+N+G	09-28035-185	09-38035-185
600V	2P+G	09-28032-185	09-38032-185
600V	3P+G	09-28033-185	09-38033-185
600V	3P+N+G	09-28037-185	09-38037-185

Notes: • 600V devices are rated for current interrupting up to 15A only

Other voltage configurations are available – contact customer service at 800.433.7642.



This high-temperature version of the PN is approved for use in temperatures up to 365°F / 185°C.

Therefore, you can supply power to electrical equipment located next to heat sources: machines, industrial facilities, steel works, metallurgy, etc.

For temperatures higher than 365°F contact Meltric.

Installation Accessories

Handles



NPT	Threaded Opening Metal Handle
1/2"	H091U12-185
3/4"	H091U34-185
1"	H091U1-185

Cable Range	Metal Handle
.32 - .47	09-2A913-67
.39 - .75	09-2A674-185
.63 - .94	09-2A675-185

NPT Guidelines

Cable Range	NPT
.312 - .625	1/2"
.438 - .812	3/4"
.660 - 1.000	1"
.875 - 1.375	1 1/4"

NPT sizes are determined by the cable diameter and third party cord grip.

Angles



Metal 45° Angle	Metal Straight Adapter
09-2A027-185	MSPN-185

Junction Boxes



NPT	Metal Box	Metal Box With Metal Angle	Metal Straight Wall Box
1/2"	MB312-NP	09-NA053-080-12-185	09-2A025-185-12
3/4"	MB334-NP	09-NA053-080-34-185	09-2A025-185-34
1"	MB31-NP	09-NA053-080-1-185	-
1 1/4"	MB314-NP	09-NA053-080-114-185	-



45° Angled Inlet

Wall Box with Inlet

Connector

Wall Box with Receptacle

Order Example

A typical order should include an inlet part number, a receptacle part number **AND** the matching handles, angles or other required accessories.



Male Inlet with Handle (Plug)
09-28017-185 + 09-2A913-67



Female Receptacle with Angle Adapter
09-24017-185 + 09-2A027-185



Spare Parts

Male Configuration

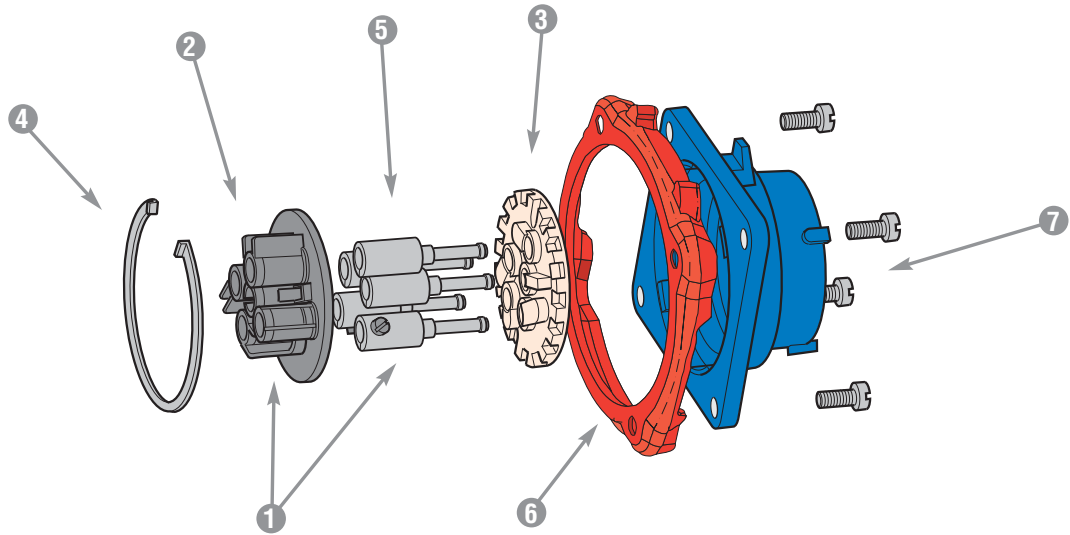

	PN20 POLY	PN20 METAL	PN20 HT METAL	PN30 HT METAL	
1 = Plug Interior	01-2A010*	01-2A010*	01-2A010-185*	01-2A010-185*	
2 = Interior Bottom	01-2A010-B	01-2A010-B	01-2A010-185-B	01-2A010-185-B	
3 = Interior Top	01-2A010-T*	01-2A010-T*	01-2A010-185-T*	01-2A010-185-T*	
4 = Locking Ring	01-NA583	09-2A583	09-2A583-185	09-2A583-185	
5 = Plug Contact	01-2A011	01-2A011	01-2A011-185	01-2A011-185	
6 = Ground Contact	01-2A019	01-2A019	01-2A019-185	01-2A019-185	
6 = Device Gasket	<div style="display: flex; align-items: center;"> <div style="width: 15px; height: 10px; border-radius: 5px; background-color: #0056b3; color: white; margin-right: 5px;">208V</div> <div style="margin-right: 5px;">61-1AB26</div> </div> <div style="display: flex; align-items: center;"> <div style="width: 15px; height: 10px; border-radius: 5px; background-color: #e69d00; color: white; margin-right: 5px;">250V</div> <div style="margin-right: 5px;">61-1AC26</div> </div> <div style="display: flex; align-items: center;"> <div style="width: 15px; height: 10px; border-radius: 5px; background-color: #c00000; color: white; margin-right: 5px;">480V</div> <div style="margin-right: 5px;">61-1AR26</div> </div> <div style="display: flex; align-items: center;"> <div style="width: 15px; height: 10px; border-radius: 5px; background-color: #e69d00; color: white; margin-right: 5px;">125V</div> <div style="margin-right: 5px;">61-1AC26</div> </div>	61-1AB26	61-1AC26	-	-
7 = Plug Casing	01-NA014**	09-NA014**	09-2A014-185**	09-2A014-185**	

* Voltage and phasing positions must be specified (5th, 6th & 7th digit of Part #) to duplicate your shutter and alignment notches.

** For appropriate labeling on a device, please specify voltage, phasing, and product type

Spare Parts

Female Configuration

PN

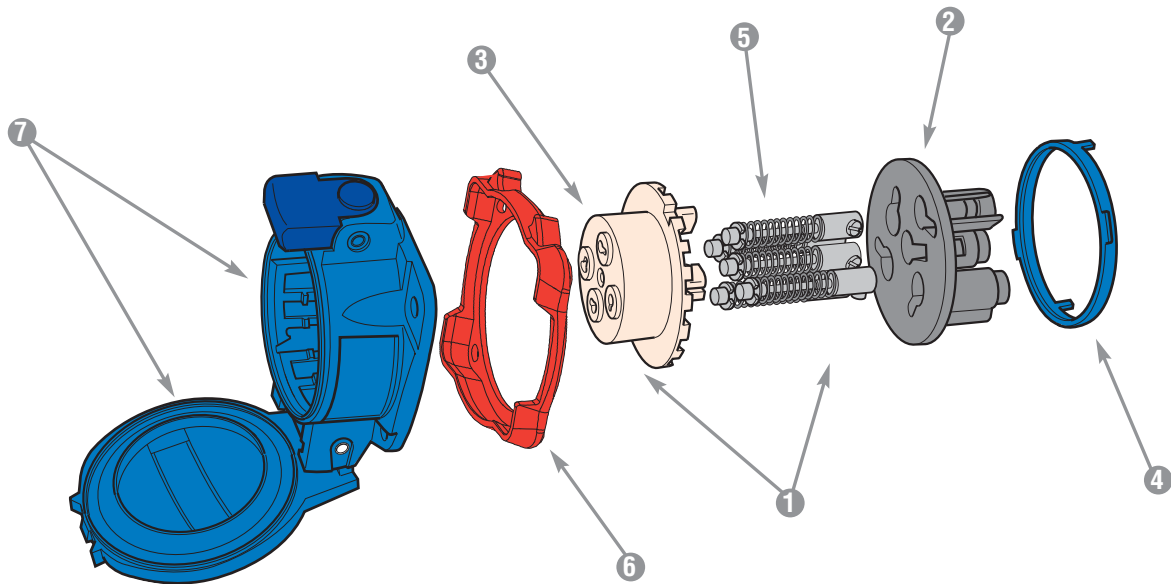

	PN20 POLY	PN20 METAL	PN20 HT METAL	PN30 HT METAL
① = Receptacle Interior	01-2A020*	01-2A020*	01-2A020-185*	01-2A020-185*
② = Interior Bottom	01-2A020-B	01-2A020-B	01-2A020-185-B	01-2A020-185-B
③ = Interior Top	01-2A020-T*	01-2A020-T*	01-2A020-185-T*	01-2A020-185-T*
④ = Locking Ring	01-NA583	09-2A583	09-2A583-185	09-2A583-185
⑤ = Receptacle Contact	01-2A021	01-2A021	01-2A021-185	01-2A021-185
⑥ = Ground Contact	01-2A029	01-2A029	01-2A029-185	01-2A029-185
⑥ = Device Gasket	208V 61-1AB26	61-1AB26	-	-
	250V 61-1AC26	61-1AC26	-	-
	480V 61-1AR26	61-1AR26	-	-
	125V 61-1AC26	61-1AC26	-	-
⑦ = Recept Casing with Lid IP54/IP55	01-SA024**	09-SA024**	09-2A024-185**	09-2A024-185**
⑦ = Recept Casing with Lid IP66+IP67	01-NA024**	09-NA024**	-	-

* Voltage and phasing positions must be specified (5th, 6th & 7th digit of Part #) to duplicate your shutter and alignment notches.

** For appropriate labeling on a device, please specify voltage, phasing, and product type

For replacement parts contact customer service at 800.433.7642

PN



Dimensions

Inlet – Provided in inches

Dimensions are for reference only and may change depending on accessories used. For precise dimensions contact Meltric Engineering.

plug

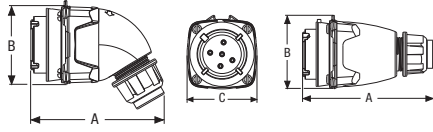

PRODUCT	A	B	C
PN/PN7/PN12 angled	3.90	3.15	2.28
PN/PN7/PN12 straight	4.33	2.40	2.28

inlet

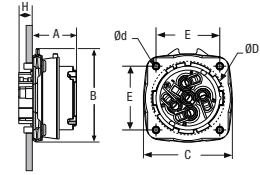

PRODUCT	A	B	C	E	H	Ød	ØD
PN/PN7/PN12	1.14	2.40	2.28	1.65	0.35	0.18	1.91

30° inclined inlet/angle with connector

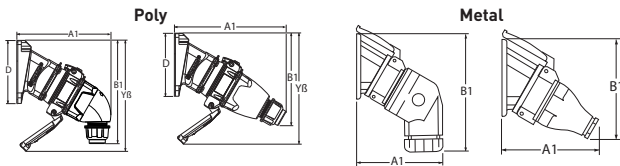

PRODUCT	A1	B1	D	YØ
PN/PN7/PN12 angled poly	5.31	5.83	3.54	6.22
PN/PN7/PN12 straight poly	6.26	5.20	3.54	6.22
PN/PN7/PN12 angled metal	5.43	6.57		
PN/PN7/PN12 straight metal	4.84	5.43		

30° inlet/angle

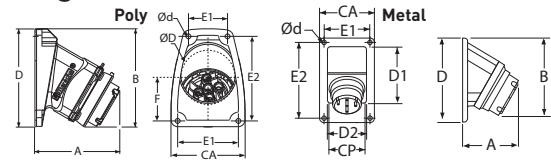

PRODUCT	A	B	CA	D	D1	D2	E1	E2	F	Ød	ØD
PN/PN7/PN12 poly	3.07	3.58	2.68	3.54			1.42	3.07	1.57	0.18	1.97
PN/PN7/PN12 metal	2.56	4.17	2.99	4.21	3.74	2.56	2.48	3.74		0.24	

30° inclined inlet/angle/ junction box with connector

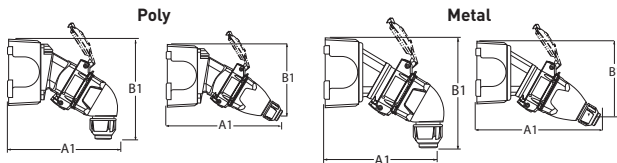

PRODUCT	A1	B1
PN/PN7/PN12 angled poly	7.52	6.30
PN/PN7/PN12 straight poly	6.73	5.67
PN/PN7/PN12 angled metal	7.91	6.69
PN/PN7/PN12 straight metal	7.32	5.55

inlet/angle/ metal junction box

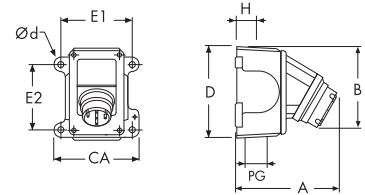

PRODUCT	A	B	CA	D	E1	E2	H	PG	Ød
PN/PN7/PN12 poly	4.53	4.06	4.40	4.57	3.75	2.78	1.18	1.00	0.25
PN/PN7/PN12 metal	5.04	4.29	4.40	4.57	3.75	2.78	1.18	1.00	0.25

inlet/straight wall box with connector

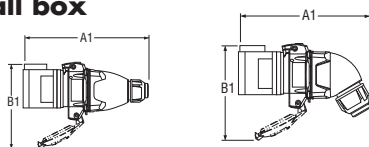

PRODUCT	A1	B1
PN/PN7/PN12 angled	6.34	3.58
PN/PN7/PN12 straight	6.02	2.76

inlet/straight wall box

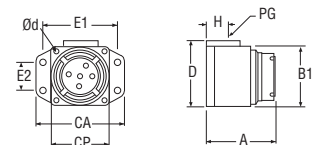

PRODUCT	A	B	CA	CP	D	E1	E2	H	PG	Ød
PN/PN7/PN12	2.60	2.17	3.07	2.17	2.40	2.52	0.94	0.69	0.50	0.22

Dimensions

Receptacle – Provided in inches

Dimensions are for reference only and may change depending on accessories used. For precise dimensions contact Meltric Engineering.

connector

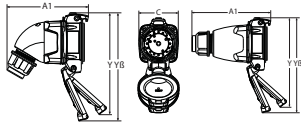

PRODUCT	A1	C	Y	YB
PN/PN7/PN12 angled	4.17	2.28	5.20	5.51
PN/PN7/PN12 straight	4.57	2.28	5.20	5.51

receptacle with plug

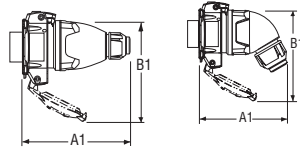

PRODUCT	A1	B1
PN/PN7/PN12 angled	4.61	2.99
PN/PN7/PN12 straight	4.72	2.99

receptacle

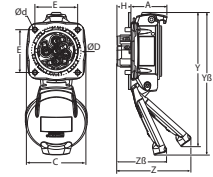

PRODUCT	A	C	E	H	Y	YB	Z	ZB	Ød	ØD
PN/PN7/PN12	1.38	2.28	1.65	0.55	5.20	5.51	2.32	1.38	0.18	1.91

30° inclined receptacle/angle with plug

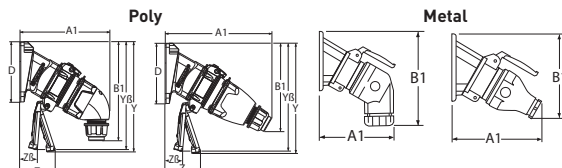

PRODUCT	A1	B1	D	Y	YB	Z	ZB
PN/PN7/PN12 angled poly	5.24	5.87	5.54	6.50	6.34	1.57	0.51
PN/PN7/PN12 straight poly	6.26	5.20	3.54	6.50	6.34	1.57	0.51
PN/PN7/PN12 angled metal	5.43	6.57					
PN/PN7/PN12 straight metal	4.84	5.43					

30° receptacle/angle

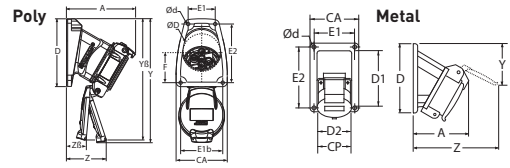

PRODUCT	A	CA	CP	D	D1	D2	E1	E1b	E2	Y	Z	ZB	Ød	ØD
PN/PN7/PN12 poly	3.62	2.68		3.54			1.42	2.20	3.07	6.50	1.57	0.51	0.18	1.97
PN/PN7/PN12 metal	3.15	2.99	2.05	4.21	3.74	2.56	2.48	2.48	3.74	6.38	2.52		0.24	

30° inclined recept/angle/ junction box w/plug

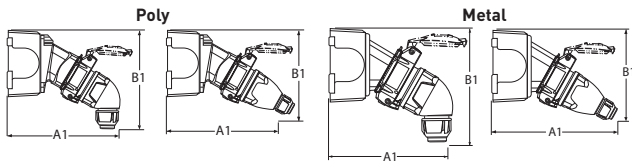

PRODUCT	A1	B1
PN/PN7/PN12 angled poly	7.13	6.30
PN/PN7/PN12 straight poly	6.93	5.16
PN angled metal	7.91	6.69
PN/PN7/PN12 straight metal	7.32	5.55

receptacle/angle/ metal junction box

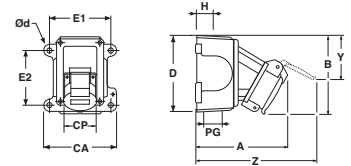

PRODUCT	A	B	CA	CP	D	E1	E2	H	PG	Y	Z	Ød
PN/PN7/PN12 poly	5.24	4.45	4.40	2.24	4.57	3.75	2.78	1.18	1.00	6.10	4.61	0.25
PN/PN7/PN12 metal	5.63	4.84	4.40	2.05	4.57	3.75	2.78	1.18	1.00	6.50	5.00	0.25

receptacle/straight wall box with plug

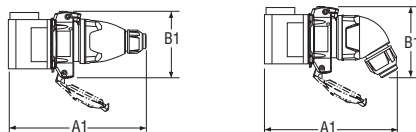

PRODUCT	A1	B1
PN/PN7/PN12 angled	5.35	3.11
PN/PN7/PN12 straight	6.38	3.01

receptacle/straight wall box

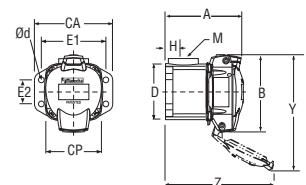

PRODUCT	A	B	CA	CP	D	E1	E2	H	PG	Y	Z	Ød
PN/PN7/PN12	2.97	3.00	3.07	2.17	2.39	2.52	0.94	0.69	0.50	5.04	4.49	0.22

DSDC

Features and Ratings

p. 168

DSDC

p. 169



DC rated plugs and receptacles

DSDC Series plugs and receptacles provide safe and robust connections for direct current applications up to 750VDC. The DSDC's spring-loaded, silver-nickel butt contacts and dead front construction provide more consistent and reliable connections and significant improvements in operator safety. DSDC plugs and receptacles are not for current interrupting. Standard locking features should be used to prevent accidental connection or disconnection under load.

Main Advantages

- ▶ Rated for Direct Currents
- ▶ Standard locking feature enables locking in the connected and disconnected mode
- ▶ Robust poly or metal construction

Product Features

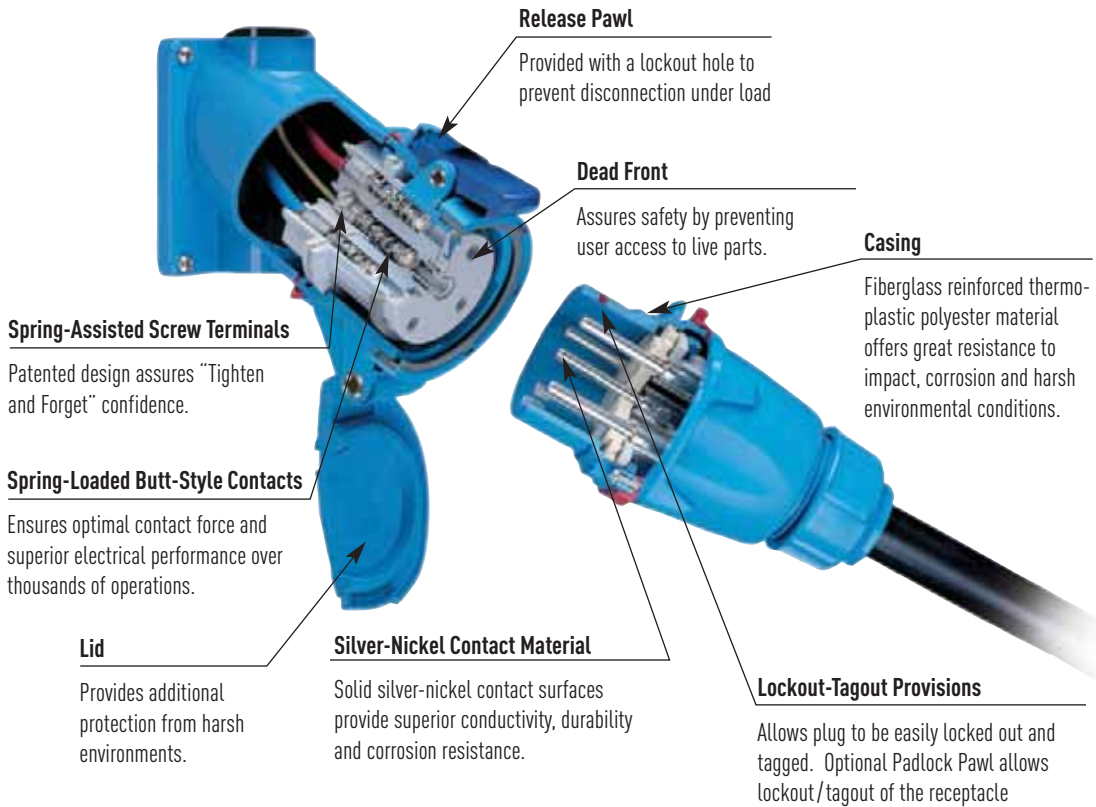

General Ratings

Voltage	130 VDC, 250 VDC, 600VDC or 750VDC
Amperage	130 VDC: 20 to 200A 250 VDC: 20 to 200A 600 VDC: 15 to 100A 750 VDC: 10 to 30A
Environmental	Type 3R, IP54/IP55*, Type 4X optional
Temperature	min -40°F / max 140°F

* IP54 rated when receptacle and plug are mated, when not mated receptacle alone is IP55 rated provided that the lid is latched closed.

Listings

Category	UL
Plugs and Receptacles	UL 1682

CE ratings available upon request

Highlighted Feature

Receptacle Lockout Hole



All DSDC models are provided with a lockout hole in the pawl. This feature allows locking of the receptacle to prevent accidental disconnection of the plug under load.

Operating Instructions



When a DSDC is under load the receptacle should be locked to prevent disconnection.



If the DSDC is NOT under load, it can be disconnected by pressing the pawl.



A quarter turn of the plug allows it to be totally withdrawn from the receptacle. This is done in complete safety as the circuit is already dead.



The plug and the receptacle are separated. The safety shutter prevents access to live parts.

5 To reconnect, insert plug into receptacle, twist slightly, and apply insertion force.

DSDC



DSDC – 130V, 250V, 600V, 750V Standard Duty Plugs & Receptacles

Receptacle (female)

Inlet (male)



Don't forget to add installation accessories to your order

Ratings

- Voltage**
110-130, 250, 600 or 750 VDC
- Current Interruption Capability**
Not for current interrupting
- Environmental Ratings**
Type 3R, IP54/ IP55*
* IP54 when the plug & receptacle are mated. IP55 on the receptacle alone when the lid is latched closed.
- Temperature Range**
Min -40°F/Max 140°F
See pg 220 for temps below -15°F.
- Wiring Capacity**
DSDC1 Min 14 AWG Max 8 AWG
DSDC3 Min 14 AWG Max 6 AWG
DSDC6 Min 10 AWG Max 2 AWG
DSDC9 Min 8 AWG Max 2/0 AWG
DSDC2 Min 4 AWG Max 2/0-AWG
+ 4/0 available by adding suffix "-A06" to the inlet and receptacle.
- Listings**
UL 1682 (130, 250 & 600 VDC)
750 VDC devices pass UL testing, but are outside the scope of the standard so they cannot be listed.

	Voltage/Amps Polarity			Part #		Voltage/Amps Polarity			Part #	
				Poly	Metal				Poly	Metal
DSDC1	130V/20A	2P+G		33-14109	-	130V/20A	2P+G		33-18109	-
DSDC3	130V/30A	2P+G		33-34109	-	130V/30A	2P+G		33-38109	-
DSDC6	130V/60A	2P+G		33-64109	37-64109	130V/60A	2P+G		33-68109	37-68109
DSDC9	130V/100A	2P+G		33-94109	37-94109	130V/100A	2P+G		33-98109	37-98109
DSDC2	130V/200A	2P+G		-	37-24109	130V/200A	2P+G		-	37-28109
<hr/>										
DSDC1	250V/20A	2P+G		33-14209	-	250V/20A	2P+G		33-18209	-
DSDC3	250V/30A	2P+G		33-34209	-	250V/30A	2P+G		33-38209	-
DSDC6	250V/60A	2P+G		33-64209	37-64209	250V/60A	2P+G		33-68209	37-68209
DSDC9	250V/100A	2P+G		33-94209	37-94209	250V/100A	2P+G		33-98209	37-98209
DSDC2	250V/200A	2P+G		-	37-24209	250V/200A	2P+G		-	37-28209
<hr/>										
DSDC1	600V/15A	2P+G*		33-14058-S82	-	600V/15A	2P+G*		33-18058-S82	-
DSDC3	600V/30A	2P+G*		33-34058-S82	-	600V/30A	2P+G*		33-38058-S82	-
DSDC6	600V/50A	2P+G*		33-64058-S82	37-64058-S82	600V/50A	2P+G*		33-68058-S82	37-68058-S82
DSDC9	600V/60A	2P+G*		33-94058-S82	-	600V/60A	2P+G*		33-98058-S82	-
DSDC2	600V/100A	2P+G*		-	37-24058-S82	600V/100A	2P+G*		-	37-28058-S82
<hr/>										
DSDC1	750V/10A	2P+G*		33-14158-S69	-	750V/10A	2P+G*		33-18158-S69	-
DSDC3	750V/20A	2P+G*		33-34158-S69	-	750V/20A	2P+G*		33-38158-S69	-
DSDC6	750V/30A	2P+G*		33-64158-S69	37-64158-S69	750V/30A	2P+G*		33-68158-S69	37-68158-S69

Notes: * Polarity for connection purposes. Devices have additional contacts used for load splitting. See information below.

Jumpers provided on 600 VDC and 750 VDC models

Jumpers are required on all 600 VDC and 750 VDC models as a safety precaution to split the arc in case of accidental disconnection under load. Plugs and receptacles are provided with jumpers installed. Receptacles utilize a jumper between N and L3 poles. Plugs utilize a jumper between L2 and N poles.

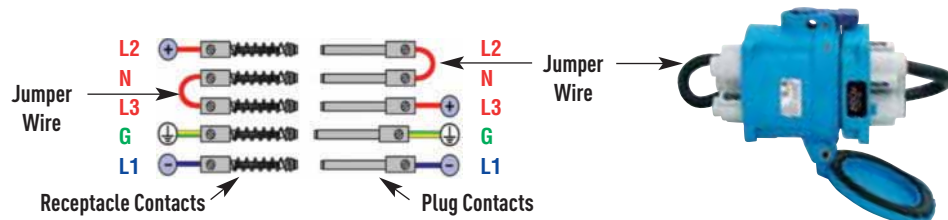

Receptacle Options Part

NEMA 4X Watertightness	Recept # - 4X
Metal Pawl (on poly receptacle)	Recept # - 824
Closed Lid Configuration	Recept # - NC

DSDC2 models are also provided with a screw locking pawl to provide an alternative means of preventing accidental disconnection under load.

Inlet Options Part

NEMA 4X Watertightness	Inlet # - 4X
With No Lockout Hole	Inlet # - A155

Installation Accessories

Handles



Nylon Handle



Poly Handle

DSDC1, 3, 6 shown



Poly Handle

DSDC9, 2 shown

	Cable Range	Nylon Handle	1/2" NPT	3/4" NPT	1" NPT	1 1/4" NPT	1 1/2" NPT	2" NPT	2 1/2" NPT
DSDC1	.20 - .83	FH111	1PH12	1PH34	1PH1	1PH114	-	-	-
DSDC3	.39 - 1.18	FH311	3PH12	3PH34	3PH1	3PH114	-	-	-
DSDC6	.51 - 1.38	FH611	6PH12	6PH34	6PH1	6PH114	6PH112	-	-
DSDC9	-	-	-	9PH34	9PH1	9PH114	9PH112	9PH2	-
DSDC2	-	-	-	-	2PH1	2PH114	2PH112	2PH2	2PH212

- Notes:**
- Finger draw plates are recommended for easier connector closure on cord to cord assemblies.
 - For available cord grips, see pgs 193-194.

Angles



	Nylon 30° Angle	Metal 30° Angle	Metal Angle FS/FD Box 30°	Metal Straight Adapter	Poly 70°** Wall Box
DSDC1	MP2	MA2	MAFS2	MS2	51-BA058
DSDC3	MP3	MA3	MAFS3	MS3	51-CA058
DSDC6	MP6	MA6	-	MS6	51-DA058
DSDC9	MP10	MA10	-	MS10	-
DSDC2	-	MA20	-	MS20	-

** 70° boxes are not drilled. Contact customer service if factory drilling is required.

Miscellaneous Accessories



* Set of Two (2)



For Male Devices Only



For Male Devices Only



	Finger Drawplates	Protective Cap	Padlockable Cap Poly	Inlet Spring-loaded Cap
DSDC1	FDP2	31-1A126	DS1PC	31-1A226
DSDC3	FDP3	31-3A126	DS3PC	31-3A226
DSDC6	FDP6	31-6A126	DS6PC	31-6A226
DSDC9	**	31-9A126	DS9MC***	-
DSDC2	**	31-2A126	DS2MC***	-

* Recommended for cord to cord assembly applications, for easier connector closure

** An easy closing mechanism is standard on DSDC9 and DSDC2

*** Padlockable Cap Aluminum - Not pictured

Junction Boxes



Metal Box

DSDC1, 3, 6 shown



Metal Box

DSDC9, 2 shown

	1/2" NPT	3/4" NPT	1" NPT	1 1/4" NPT	1 1/2" NPT	2" NPT	2 1/2" NPT
DSDC1	MB312	MB334	MB31	MB3114	-	-	-
DSDC3	MB312	MB334	MB31	MB3114	-	-	-
DSDC6	-	-	MB61	MB6114	MB6112	MB62	-
DSDC9	-	-	-	MB10114	MB10112	MB102	MB10212
DSDC2	-	-	-	-	MB20112	MB202	MB20212



Poly Conduit Box For poly devices only

	1/2" NPT	3/4" NPT	1" NPT	1 1/4" NPT
DSDC1	MC212	MC234	-	-
DSDC3	MC312	MC334	MC31	-
DSDC6	MC612	MC634	MC61	MC6114

For DSDC dimensions use the cross reference chart below and refer to DS dimensions on pgs 51-52.

Dimensions	
DSDC1	same as DS20
DSDC3	same as DS30
DSDC6	same as DS60
DSDC9	same as DS100
DSDC2	same as DS200

Specialty Products



Custom Power Distribution	p. 173
Integral Circuit Protection Wall Boxes	p. 179
Disconnect Combinations	p. 185
WS – Welding Connectors	p. 187
LC – Battery Connectors	p. 188
Adapter Plates	p. 189
Cord Grips	p. 193
Voltage/Phase Rotation Meter	p. 195



Specialty Products

Meltric manufactures a wide variety of specialty products to fit specific application needs and to help users benefit from the advantages of Meltric's switch rated DECONTACTOR™ Series plugs and receptacles where ever connections may need to be made and broken.

Main Advantages

- ▶ Portable Power Distribution – Provide switch rated safety where ever connections are made
- ▶ Disconnect Combinations – Provide convenience and visual verification of deenergization
- ▶ Integral Circuit Wall Protection Boxes – Provide convenience and visual
- ▶ Backbox Adapter Plates – Simplify replacement of competitive devices with Decontactors
- ▶ Cord Grips – Enhance strain relief and cord gripping
- ▶ WS Single Pole Welding Connectors – Fast and reliable connections
- ▶ LC Battery Connectors – Easy operation with the safety of silver-nickel butt style contacts
- ▶ Voltage/Phase Rotation Meter – Easy means of testing Meltric receptacles for voltage

Specialty Products



Custom Power Distribution

Meltric can provide a wide range of power distribution packages built specifically to customer needs.



Disconnect Combinations

For applications where over current or additional short circuit protection is desired Meltric offers Safety Switch/ Receptacle combinations.



WS – Welding Connectors

For fast connections of welding cables with the reliability of silver-nickel butt style contacts.



LC – Battery Connectors

Designed to provide quick and easy operation and assure a superior electrical connection in battery charging applications.



Adapter Plates

For mounting Decontactor™ receptacles on existing back boxes that were previously used for competitive devices.



Cord Grips

For inline and other high stress applications where additional cord gripping and strain relief capabilities are beneficial.



Voltage /Phase Rotation Meter

Provides a simple means of testing receptacles to identify if voltage is available and to determine motor rotation.



Custom Power Distribution



Custom power solutions from Meltric provide the switch rated safety and durability of Meltric Decontactor™ Series plugs and receptacles in a power distribution package built specifically to customer needs. Whether you require power distribution in a vertical stand configuration, a low profile horizontal configuration, a custom configuration, or as a cordset; Meltric's engineering team can build a package to meet your needs.

Available Features:

Input Breaker Protection

NEMA Rated Enclosures

GFCI Protection

Color Coded Enclosures

Phase Indication

Stainless Steel Enclosures

120V Convenience Outlet

Rain Hoods

Timers

Pilot Circuits

Wheel Kits

Shunt Trips

Under Voltage Trips

Lifting Provisions

Power Transformers



Common Platforms



Power/Transformer Assembly



Vertical Power



Horizontal Multigang



Spider Cart Assembly



Rubber Box



Portable Panel Assembly



Wall Mounted Panel Assembly



Cable Assembly



Breaker Plate Assembly

If you don't see what you are looking for, call Meltric @ 800.433.7642



Power Distribution

Rubber Boxes

UL Type 3R Enclosures



1 Tier

3 Tier

2 Tier

Choose from standard configurations on pages 172-174 or contact Meltric at 800.433.7642 for customized configurations.

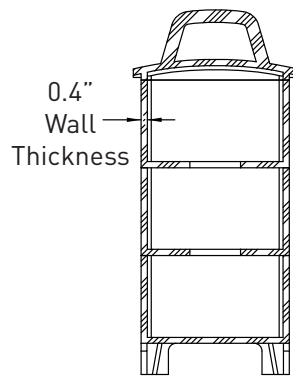
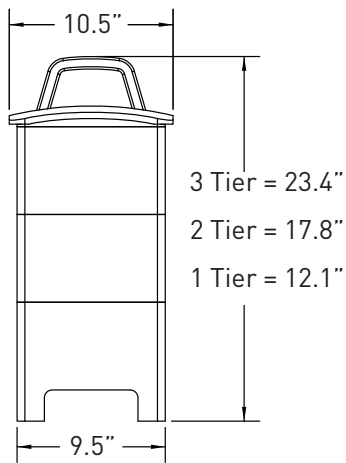

Cross-Section of Enclosure

Power Input up to 100A:
Choose a mounted inlet
or a cord & plug



Mounted Inlet



Cord & Plug

Power Receptacles



Room for (2) DSN60 (or smaller) receptacles per side per tier.

Circuit Protection



Room for up to (10) poles of standard MCB's (mini circuit breakers) per tier.

Convenience Outlets



Room for (2) NEMA 5-20R duplex receptacles per side per tier or choose other convenience outlets.

1 Tier Rubber Power Distribution Boxes

Configuration T1-C1

Notes: Two receptacles share a 3P breaker.



Side 1

(2) DSN Receptacles



Side 2

(2) 3 Pole MCB's*



Side 3

(2) DSN Receptacles



Side 4

(1) Inlet

Voltage	Contacts	Part #'s: Configuration T1-C1-20A	Part #'s: Configuration T1-C1-30A	Part #'s: Configuration T1-C1-60A
		20A DSN Recepts & 30A DSN Inlet	30A DSN Recepts & 60A DSN Inlet	60A DSN Recepts & 100A DS100C Inlet
120/208V	3P+N+G	RBT1-C1-167-20A	RBT1-C1-167-30A	RBT1-C1-167-60A
125/250V	3P+N+G	RBT1-C1-077-20A	RBT1-C1-077-30A	RBT1-C1-077-60A
480V	3P+G	RBT1-C1-043-20A	RBT1-C1-043-30A	RBT1-C1-043-60A

Configuration T1-C2



Side 1

(1) DSN Receptacle
(1) 20A NEMA 5-20 Duplex GFCI



Side 2

(2) 3 Pole MCB's*
(2) 20A 1 Pole MCB's



Side 3

(1) DSN Receptacle
(1) 20A NEMA 5-20 Duplex GFCI



Side 4

(1) Inlet

Voltage	Contacts	Part #'s: Configuration T1-C2-20A	Part #'s: Configuration T1-C2-30A	Part #'s: Configuration T1-C2-60A
		20A DSN Recepts & 30A DSN Inlet	30A DSN Recepts & 60A DSN Inlet	60A DSN Recepts & 100A DS100C Inlet
120/208V	3P+N+G	RBT1-C2-167-20A	RBT1-C2-167-30A	RBT1-C2-167-60A
125/250V	3P+N+G	RBT1-C2-077-20A	RBT1-C2-077-30A	RBT1-C2-077-60A

Configuration T1-C3



Side 1

(1) DSN 30A Receptacle
(1) DSN 20A Receptacle



Side 2

(2) 30A 3 Pole MCB
(1) 20A 3 Pole MCB



Side 3

(1) DSN 30A Receptacle
(1) DSN 20A Receptacle



Side 4

(1) DSN 60A Inlet

Voltage	Contacts	Part #'s: Configuration T1-C3
		20/30A DSN Recepts & 60A DSN Inlet
120/208V	3P+N+G	RBT1-C3-167
125/250V	3P+N+G	RBT1-C3-077
480V	3P+G	RBT1-C3-043

Notes: 30A receptacles are protected by individual 30A breakers. 20A receptacles share a 20A breaker.

* Ampacity ratings of MCB's match the receptacles they protect.



2 Tier Rubber Power Distribution Boxes

Configuration T2-C1



Side 1

- (1) DSN 30A Receptacle
- (1) DSN 20A Receptacle
- (1) DSN 60A Receptacle



Side 2

- (2) 30A 3 Pole MCB's
- (2) 20A 3 Pole MCB's
- (2) 60A 3 Pole MCB's
- (2) 20A 1 Pole MCB's



Side 3

- (1) DSN 30A Receptacle
- (1) DSN 20A Receptacle
- (1) DSN 60A Receptacle



Side 4

- (2) 20A NEMA 5-20 Duplex GFCI
- (1) DS100C 100A Inlet

		Part #'s: Configuration T2-C1	
		20/30/60A DSN Receptacles & 100A DS100C Inlet	
Voltage	Contacts		
120/208V	3P+N+G	RBT2-C1-167	
125/250V	3P+N+G	RBT2-C1-077	

Configuration T2-C2



Side 1

- (4) DSN Receptacles



Side 2

- (4) 3 Pole MCB's*
- (2) 20A 1 Pole MCB's



Side 3

- (4) DSN Receptacles



Side 4

- (2) 20A NEMA 5-20 Duplex GFCI
- (1) DS100C 100A Inlet

		Part #'s: Configuration T2-C2-20A	Part #'s Configuration T2-C2-30A
		20A DSN Receptacles & 100A DS100C Inlet	30A DSN Receptacles & 100A DS100C Inlet
Voltage	Contacts		
120/208V	3P+N+G	RBT2-C2-167-20A	RBT2-C2-167-30A
125/250V	3P+N+G	RBT2-C2-077-20A	RBT2-C2-077-30A

* Ampacity ratings of MCB's match the receptacles they protect.

3 Tier Rubber Power Distribution Boxes

Configuration T3-C1



Side 1

- (1) 20A NEMA 5-20 Duplex GFCI
- (2) DSN 20A Receptacles
- (2) DSN 30A Receptacles



Side 2

- (6) 20A 1 Pole MCB's
- (4) 20A 3 Pole MCB's
- (4) 30A 3 Pole MCB's



Side 3

- (1) 20A NEMA 5-20 Duplex GFCI
- (2) DSN 20A Receptacles
- (2) DSN 30A Receptacles



Side 4

- (4) 20A NEMA 5-20 Duplex GFCI
- (1) DS100C 100A Inlet

		Part #'s: Configuration T3-C1	
		20A & 30A DSN Receptacles & 100A DS100C Inlet	
Voltage	Contacts		
120/208V	3P+N+G	RBT3-C1-167	
125/250V	3P+N+G	RBT3-C1-077	

Configuration T3-C2



Side 1

- (4) DSN 20 or (4) 30A Receptacles
- (1) DSN 60A Receptacle



Side 2

- (4) 3 Pole MCB's*
- (2) 60A 3 Pole MCB's
- (4) 20A 1 Pole MCB's



Side 3

- (4) DSN 20 or (4) 30A Receptacles
- (1) DSN 60A Receptacle



Side 4

- (4) 20A NEMA 5-20 Duplex GFCI
- (1) DS100C 100A Inlet

		Part #'s: Configuration T3-C2-20A	Part #'s: Configuration T3-C2-30A
		20A & 60A DSN Receptacles & 100A DS100C Inlet	30A & 60A DSN Receptacles & 100A DS100C Inlet
Voltage	Contacts		
120/208V	3P+N+G	RBT3-C2-167-20A	RBT3-C2-167-30A
125/250V	3P+N+G	RBT3-C2-077-20A	RBT3-C2-077-30A

* Ampacity ratings of MCB's match the receptacles they protect.



Receptacles & Wall Boxes with Integral Circuit Protection



Meltric's receptacle/wall box combinations with integral circuit protection combine the safety of a Meltric DSN series switch rated receptacle with the convenience of local circuit protection in a compact package. The receptacle is premounted to the box and wired to the circuit protection device for easy installation.

Models are available with or without a viewing window and in either painted mild steel or stainless steel enclosures. The 20A and 30A models are available and equipped with fuse holders or mini-circuit breakers and the 60A models are available with fuseholders or supplementary protectors.

Fuseholder Equipped Models



Meltric's DSN Decontactor™ Series switch rated plugs and receptacles are UL rated to withstand and close-into short circuit currents up to 100kA in circuits protected by RK1 current limiting fuses or other fuses with lower let through energy like Class CC and Class J fuses. This allows users to take advantage of the DSN's capabilities in applications where higher fault currents are not already protected with the required fusing.

Fuseholder models feature Ferraz Shawmut Ultra-Safe Fuse Holders (UL 512 / IEC 269). The fuseholders have a blown fuse indicator light for each pole and pivot open for easy and finger safe fuse replacement. Fuses are not provided. They should be selected for the specific application.

Circuit Breaker Equipped Models



Circuit-breaker equipped models allow users to provide overload protection in a convenient location near the application. The 20A & 30A models feature Eaton WMZT miniature circuit breakers (UL 489) and the 60A models use Eaton WMZS supplementary protectors (UL 1077). All are provided standard with a 'C' trip curve. A 'D' trip curve for the 20A and 30A breakers, and a 'B' trip curve for the 60A supplementary protectors are also available as options.

Trip Curve Characteristics

- "B" Curve: The protective device will instantaneously trip @ 3X to 5X its rated current
- "C" Curve: The protective device will instantaneously trip @ 5X to 10X its rated current
- "D" Curve: The protective device will instantaneously trip @ 10X to 20X its rated current

Enclosures

The wall boxes are Hoffman Inline® series enclosures.

Dimensions: **20A/30A Fuse Holder/Circuit Breaker**
 Box exteriors = 9.84" x 7.87" x 5.91" (250mm x 200mm x 150mm)
 Mounting footprint = 12.5" x 8" including the pre-installed mounting brackets

60A Supplementary Circuit Breaker
 Box exteriors = 9.84" x 7.87" x 5.91" (250mm x 200mm x 150mm)
 Mounting footprint = 12.5" x 8" including the pre-installed mounting brackets

60A Fuse Holder
 Box exteriors = 11.81" x 9.84" x 5.91" (300mm x 250mm x 150mm)
 Mounting footprint = 14.4" x 9.8" including the pre-installed mounting brackets

Box Materials: Mild steel boxes are 16 gauge, stainless steel boxes are 14 gauge type 304
 Available door windows are 3/16" clear polycarbonate

Latch: Quarter turn slotted stainless steel design for easy operation and durability

Finish: Mild steel boxes are painted with a light gray textured polyester powdercoat
 Stainless Steel boxes have a #4 brushed finish

Environmental: Mild steel boxes are NEMA Type 4 and 12
 Stainless steel boxes are NEMA Type 4, 4X and 12



Circuit Protected Receptacles

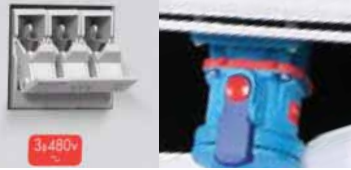

Mild Steel Boxes with Ultra-Safe Fuse Holders

Ratings

- Voltage**
 20A: 480 VAC
 30A: 600 VAC
 60A: 600 VAC
- Environmental Ratings**
 Overall: NEMA Type 4
 Box: NEMA Type 4, 12
 Receptacle: NEMA Type 4X
- Temperature Range**
 Min -40°F/Max 140°F
- Listings**
 Box: UL 508A

 Receptacle: UL Subject 2682, UL 1682, CSA 22.2 No. 182.1, IEC 60309-1

 Fuseholder: UL 512, IEC 269

Standard Box



Box with Viewing Window



Voltage	Polarity	Part #			Part #		
		20A	30A	60A	20A	30A	60A
120/208V	3P+N+G	FB-63-14167	FB-63-34167	FB-63-64167	FBW-63-14167	FBW-63-34167	FBW-63-64167
125V	1P+N+G	FB-63-14075	FB-63-34075	FB-63-64075	FBW-63-14075	FBW-63-34075	FBW-63-64075
125/250V	2P+N+G	FB-63-14076	FB-63-34076	FB-63-64076	FBW-63-14076	FBW-63-34076	FBW-63-64076
208V	2P+G	FB-63-14162	FB-63-34162	FB-63-64162	FBW-63-14162	FBW-63-34162	FBW-63-64162
208V	3P+G	FB-63-14163	FB-63-34163	FB-63-64163	FBW-63-14163	FBW-63-34163	FBW-63-64163
250V	2P+G	FB-63-14072	FB-63-34072	FB-63-64072	FBW-63-14072	FBW-63-34072	FBW-63-64072
250V	3P+G	FB-63-14073	FB-63-34073	FB-63-64073	FBW-63-14073	FBW-63-34073	FBW-63-64073
277V	1P+N+G	FB-63-14045	FB-63-34045	FB-63-64045	FBW-63-14045	FBW-63-34045	FBW-63-64045
277/480V	3P+N+G	FB-63-14047	FB-63-34047	FB-63-64047	FBW-63-14047	FBW-63-34047	FBW-63-64047
347/600V	3P+N+G	n/a	FB-63-34147	FB-63-64147	n/a	FBW-63-34147	FBW-63-64147
480V	2P+G	FB-63-14042	FB-63-34042	FB-63-64042	FBW-63-14042	FBW-63-34042	FBW-63-64042
480V	3P+G	FB-63-14043	FB-63-34043	FB-63-64043	FBW-63-14043	FBW-63-34043	FBW-63-64043
600V	2P+G	n/a	FB-63-34142	FB-63-64142	n/a	FBW-63-34142	FBW-63-64142
600V	3P+G	n/a	FB-63-34143	FB-63-64143	n/a	FBW-63-34143	FBW-63-64143

Main Options



Auxiliary Contacts



Mushroom Pawl



Padlock Pawl



Closed Lid Configuration
Lid springs to a mostly closed, pre-latch position.

Receptacle Options

Part

With 2 auxiliary contacts (30A only)	Part # - 972
Mushroom Pawl	Part # - 375
Padlock Pawl	Part # - 843
Closed lid configuration	Part # - NC



"Ferraz Shawmut 30A, 600V Ultra-Safe Fuse Holders for Class CC fuses are standard. They include a blown fuse indicator for each pole. Fuses are not included.

See pgs 197-206 for detailed information on these options

Stainless Steel Boxes with Ultra-Safe Fuse Holders

Standard Box



Box with Viewing Window



Ratings

- **Voltage**
20A: 480 VAC
30A: 600 VAC
60A: 600 VAC
- **Environmental Ratings**
Overall: NEMA Type 4X
Box: NEMA Type 4X, 12
Receptacle: NEMA Type 4X
- **Temperature Range**
Min -40°F / Max 140°F
- **Listings**
Box: UL 508A
Receptacle: UL Subject 2682,
UL 1682, CSA 22.2 No. 182.1,
IEC 60309-1
Fuseholder: UL 512, IEC 269

Voltage Polarity	Part #			Part #		
	20A	30A	60A	20A	30A	60A
120/208V	3P+N+G FBSS-63-14167	FBSS-63-34167	FBSS-63-64167	FBWSS-63-14167	FBWSS-63-34167	FBWSS-63-34167
125V	1P+N+G FBSS-63-14075	FBSS-63-34075	FBSS-63-64075	FBWSS-63-14075	FBWSS-63-34075	FBWSS-63-34075
125/250V	2P+N+G FBSS-63-14076	FBSS-63-34076	FBSS-63-64076	FBWSS-63-14076	FBWSS-63-34076	FBWSS-63-34076
208V	2P+G FBSS-63-14162	FBSS-63-34162	FBSS-63-64162	FBWSS-63-14162	FBWSS-63-34162	FBWSS-63-34162
208V	3P+G FBSS-63-14163	FBSS-63-34163	FBSS-63-64163	FBWSS-63-14163	FBWSS-63-34163	FBWSS-63-34163
250V	2P+G FBSS-63-14072	FBSS-63-34072	FBSS-63-64072	FBWSS-63-14072	FBWSS-63-34072	FBWSS-63-34072
250V	3P+G FBSS-63-14073	FBSS-63-34073	FBSS-63-64073	FBWSS-63-14073	FBWSS-63-34073	FBWSS-63-34073
277V	1P+N+G FBSS-63-14045	FBSS-63-34045	FBSS-63-64045	FBWSS-63-14045	FBWSS-63-34045	FBWSS-63-34045
277/480V	3P+N+G FBSS-63-14047	FBSS-63-34047	FBSS-63-64047	FBWSS-63-14047	FBWSS-63-34047	FBWSS-63-34047
347/600V	3P+N+G n/a	FBSS-63-34147	FBSS-63-64147	n/a	FBWSS-63-34147	FBWSS-63-34147
480V	2P+G FBSS-63-14042	FBSS-63-34042	FBSS-63-64042	FBWSS-63-14042	FBWSS-63-34042	FBWSS-63-34042
480V	3P+G FBSS-63-14043	FBSS-63-34043	FBSS-63-64043	FBWSS-63-14043	FBWSS-63-34043	FBWSS-63-34043
600V	2P+G n/a	FBSS-63-34142	FBSS-63-64142	n/a	FBWSS-63-34142	FBWSS-63-34142
600V	3P+G n/a	FBSS-63-34143	FBSS-63-64143	n/a	FBWSS-63-34143	FBWSS-63-34143

Receptacle Options	Part #
With 2 auxiliary contacts (30A only)	Recept # - 972
Mushroom Pawl	Recept # - 375
Padlock Pawl	Recept # - 843
Closed lid configuration	Recept # - NC



*Ferraz Shawmut 30A, 600V Ultra-Safe Fuse Holders for Class CC fuses are standard. They include a blown fuse indicator for each pole. Fuses are not included.

Main Options



**Auxiliary
Contacts**



**Emergency
Stop Pawl**



Padlock Pawl



**Closed Lid
Configuration**
*Lid springs to a
mostly closed,
prelatch position.*



See pgs 197-206 for detailed information on these options

Circuit Protected Receptacles



Mild Steel Boxes with Circuit Breakers

Ratings

- **Voltage**
480 VAC
- **Environmental Ratings**
Overall: NEMA Type 4
Box: NEMA Type 4, 12
Receptacle: NEMA Type 4X
- **Temperature Range**
Min -40°F / Max 140°F for 20A & 30A
Min 23°F / Max 104°F for 60A
- **Listings**
Box: UL 508A
Receptacle: UL Subject 2682, UL 1682, CSA 22.2 No. 182.1, IEC 60309-1
Breaker: UL 489 for 20A & 30A, UL 1077 for 60A

Standard Box



Box with Viewing Window



Voltage	Polarity	Part #			Part #		
		20A	30A	60A	20A	30A	60A
120/208V	3P+N+G	CB-63-14167	CB-63-34167	CB-63-64167	CBW-63-14167	CBW-63-34167	CBW-63-64167
125V	1P+N+G	CB-63-14075	CB-63-34075	CB-63-64075	CBW-63-14075	CBW-63-34075	CBW-63-64075
125/250V	2P+N+G	CB-63-14076	CB-63-34076	CB-63-64076	CBW-63-14076	CBW-63-34076	CBW-63-64076
208V	2P+G	CB-63-14162	CB-63-34162	CB-63-64162	CBW-63-14162	CBW-63-34162	CBW-63-64162
208V	3P+G	CB-63-14163	CB-63-34163	CB-63-64163	CBW-63-14163	CBW-63-34163	CBW-63-64163
250V	2P+G	CB-63-14072	CB-63-34072	CB-63-64072	CBW-63-14072	CBW-63-34072	CBW-63-64072
250V	3P+G	CB-63-14073	CB-63-34073	CB-63-64073	CBW-63-14073	CBW-63-34073	CBW-63-64073
277V	1P+N+G	CB-63-14045	CB-63-34045	CB-63-64045	CBW-63-14045	CBW-63-34045	CBW-63-64045
277/480V	3P+N+G	CB-63-14047	CB-63-34047	CB-63-64047	CBW-63-14047	CBW-63-34047	CBW-63-64047
480V	2P+G	CB-63-14042	CB-63-34042	CB-63-64042	CBW-63-14042	CBW-63-34042	CBW-63-64042
480V	3P+G	CB-63-14043	CB-63-34043	CB-63-64043	CBW-63-14043	CBW-63-34043	CBW-63-64043

Main Options



Auxiliary Contacts



Mushroom Pawl



Padlock Pawl



Closed Lid Configuration
Lid springs to a mostly closed, prelatch position.

Receptacle Options

Part

With 2 auxiliary contacts (30/60A only)	Part # - 972
With 3 auxiliary contacts (60A only)	Part # - 973*
With 4 auxiliary contacts (60A only)	Part # - 974*
Mushroom Pawl	Part # - 375
Padlock Pawl	Part # - 843
Closed lid configuration	Part # - NC

Notes: * Not UL/CSA Listed

Circuit Protection Options

Part

'D' Trip Curve (20/30A only)	Part # - D
'B' Trip Curve (60A only)	Part # - B
Standard circuit protectors include a 'C' trip curve.	
20A: Eaton 20A, 480V 'WMZT' circuit breaker*	
30A: Eaton 30A, 480V 'WMZT' circuit breaker*	
60A: Eaton 63A, 480V 'WMZS' supplementary protector**	

* or equivalent UL 489 circuit breaker

** or equivalent UL 1077 supplementary protector



See pgs 197-206 for detailed information on these options

Stainless Steel Boxes with Circuit Breakers

Standard Box



Box with Viewing Window



Voltage	Polarity	Part #			Part #		
		20A	30A	60A	20A	30A	60A
120/208V	3P+N+G	CBSS-63-14167	CBSS-63-34167	CBSS-63-64167	CBWSS-63-14167	CBWSS-63-34167	CBWSS-63-64167
125V	1P+N+G	CBSS-63-14075	CBSS-63-34075	CBSS-63-64075	CBWSS-63-14075	CBWSS-63-34075	CBWSS-63-64075
125/250V	2P+N+G	CBSS-63-14076	CBSS-63-34076	CBSS-63-64076	CBWSS-63-14076	CBWSS-63-34076	CBWSS-63-64076
208V	2P+G	CBSS-63-14162	CBSS-63-34162	CBSS-63-64162	CBWSS-63-14162	CBWSS-63-34162	CBWSS-63-64162
208V	3P+G	CBSS-63-14163	CBSS-63-34163	CBSS-63-64163	CBWSS-63-14163	CBWSS-63-34163	CBWSS-63-64163
250V	2P+G	CBSS-63-14072	CBSS-63-34072	CBSS-63-64072	CBWSS-63-14072	CBWSS-63-34072	CBWSS-63-64072
250V	3P+G	CBSS-63-14073	CBSS-63-34073	CBSS-63-64073	CBWSS-63-14073	CBWSS-63-34073	CBWSS-63-64073
277V	1P+N+G	CBSS-63-14045	CBSS-63-34045	CBSS-63-64045	CBWSS-63-14045	CBWSS-63-34045	CBWSS-63-64045
277/480V	3P+N+G	CBSS-63-14047	CBSS-63-34047	CBSS-63-64047	CBWSS-63-14047	CBWSS-63-34047	CBWSS-63-64047
480V	2P+G	CBSS-63-14042	CBSS-63-34042	CBSS-63-64042	CBWSS-63-14042	CBWSS-63-34042	CBWSS-63-64042
480V	3P+G	CBSS-63-14043	CBSS-63-34043	CBSS-63-64043	CBWSS-63-14043	CBWSS-63-34043	CBWSS-63-64043

Ratings

- Voltage**
20A: 480 VAC
30A: 480 VAC
60A: 480 VAC
- Environmental Ratings**
Overall: NEMA Type 4X
Box: NEMA Type 4X, 12
Receptacle: NEMA Type 4X
- Temperature Range**
Min -40°F / Max 140°F
- Listings**
Box: UL 508A
Receptacle: UL Subject 2682,
UL 1682, CSA 22.2 No. 182.1,
IEC 60309-1

Receptacle Options	Part #	Circuit Protection Options	Part #
With 2 auxiliary contacts (30/60A only)	Part # - 972	'D' Trip Curve (20/30A only)	Part # - D
With 3 auxiliary contacts (60A only)	Part # - 973*	'B' Trip Curve (60A only)	Part # - B
With 4 auxiliary contacts (60A only)	Part # - 974*	Standard circuit protectors include a 'C' trip curve.	
Mushroom Pawl	Part # - 375	20A: Eaton 20A, 480V 'WMZT' circuit breaker*	
Padlock Pawl	Part # - 843	30A: Eaton 30A, 480V 'WMZT' circuit breaker*	
Closed lid configuration	Part # - NC	60A: Eaton 63A, 480V 'WMZS' supplementary protector**	

** or equivalent UL 489 circuit breaker*
*** or equivalent UL 1077 supplementary protector*

Notes: * Not UL/CSA Listed



Main Options



**Auxiliary
Contacts**



**Emergency
Stop Pawl**



Padlock Pawl



**Closed Lid
Configuration**
*Lid springs to a
mostly closed,
prelatch position.*



See pgs 197-206 for detailed information on these options



Safety Switch / Receptacle Combinations



Meltric's non-interlocked safety switch disconnects are intended for use in power supply applications where additional over current and short circuit protection is desired. Since Decontactor™ Series products are UL and CSA Switch rated, there is no need for the receptacle to be interlocked to the switch. The load may be safely made or broken by throwing the switch lever or by simply connecting or disconnecting the plug.

The standard Meltric Safety Switch Disconnect consists of a DS Series receptacle and angle mounted and wired to a heavy duty, single throw, fusible safety switch. They can optionally be provided with DSN or DB series Decontactors, straight mounting adapters, non-fused switches, or with circuit breaker protection.

Options:

DSN Receptacle (DS is standard)

DB Receptacle

Straight Adapter (Angle is standard)

Non-Fused (Fused is standard)

Viewing Window

Reverse Service

Canadian CSA listed enclosure



Receptacle/Disconnect Combinations



Meltric's standard offerings use Eaton/Cutler-Hammer safety switches. Other manufacturers switches are available upon request.



Voltage	Polarity	Part #	Part #		Part #		Part #
		30A Poly	60A Poly	60A Metal	100A Poly	100A Metal	200A Metal
120/208V	2P+N+G	33-37166-22X	33-67166-22X	37-67166-22X	33-97166-22X	37-97166-22X	37-27166-22X
120/208V	3P+N+G	33-37167-42X	33-67167-42X	37-67167-42X	33-97167-42X	37-97167-42X	37-27167-42X
125/250V	2P+N+G	33-37076-22X	33-67076-22X	37-67076-22X	33-97076-22X	37-97076-22X	37-27076-22X
3Ø/208V	3P+G	33-37163-32X	33-67163-32X	37-67163-32X	33-97163-32X	37-97163-32X	37-27163-32X
208V	2P+G	33-37162-12X	33-67162-12X	37-67162-12X	33-97162-12X	37-97162-12X	37-27162-12X
250V	2P+G	33-37072-12X	33-67072-12X	37-67072-12X	33-97072-12X	37-97072-12X	37-27072-12X
480V	2P+G	33-37042-12X	33-67042-12X	37-67042-12X	33-97042-12X	37-97042-12X	37-27042-12X
277/480V	2P+N+G	33-37046-22X	33-67046-22X	37-67046-22X	33-97046-22X	37-97046-22X	37-27046-22X
277/480V	3P+N+G	33-37047-42X	33-67047-42X	37-67047-42X	33-97047-42X	37-97047-42X	37-27047-42X
3Ø/480V	3P+G	33-37043-32X	33-67043-32X	37-67043-32X	33-97043-32X	37-97043-32X	37-27043-32X
347/600V	2P+N+G	33-37146-22X	33-67146-22X	37-67146-22X	33-97146-22X	37-97146-22X	-
347/600V	3P+N+G	33-37147-42X	33-67147-42X	37-67147-42X	33-97147-42X	37-97147-42X	-
3Ø/600V	3P+G	33-37143-32X	33-67143-32X	37-67143-32X	33-97143-32X	37-97143-32X	-
600V	2P+G	33-37142-12X	33-67142-12X	37-67142-12X	33-97142-12X	37-97142-12X	-

Notes: • When ordering a Safety Switch Disconnect, replace the "X" with the appropriate number that represents the NEMA Rating of choice.

• For higher amperage devices, contact Meltric's Sales Office.

NEMA Guidelines

X (Number)	NEMA Rating
9	NEMA 4X
7	NEMA 12
5	NEMA 3R
1	NEMA 1

Ordering Information for Optional Configurations

DSN Receptacle: To order a DSN receptacle (20-60A), change prefix "33" to "63". Example: DSN 60A Poly Receptacle 250 VAC (2P+G) NEMA 1 = 63-67072-121

DB Receptacle: To order a DB receptacle (30-100A), change prefix "33" or "37" to "89". Example: DB 60A Metal Receptacle 250 VAC (2P+G) NEMA 4X = 89-67072-129

Straight Adapter: To order a straight adapter, add suffix -S to the part number. Example: DS 60A Metal Receptacle 480 VAC (3P+G) NEMA 1 = 37-67043-321-S

Non-Fused: To order a non fused device, add suffix -NF to the part number. Example: DS 30A Poly Receptacle 250 VAC (2P+G) NEMA 3R = 33-37072-125-NF

Canadian: To order a CSA listed enclosure, add suffix -CSA to the part number. CSA enclosures are provided with viewing windows as standard.



WS – Welding Connectors

General Ratings

- **Voltage**
50 VAC Max
- **Amperage**
325A Continuous
500A Intermittent

Notes: The chart to the right is a guideline for wiring sizes based on duty cycles.

WS devices allow users to make fast and reliable connections of welding cables. Their spring-loaded silver contacts provide connections that are unaffected by cable movement or vibration and operate with a self-cleaning wiping action that ensures a reliable electrical connection every time.

Wiring Hole in ²	mm ²	Maximum Amperage Cycle (5 min Cycle)		
		30% Duty	60% Duty	100% Duty
.025	16	150A	100A	75A
.047	30	200A	125A	100A
.062	40	250A	150A	125A
.078	50	300A	200A	150A
.116	75	350A	250A	200A
.155	100	400A	300A	250A
.186	120	450A	350A	275A
.233	150	500A	450A	325A

Application Note

Interchangeability

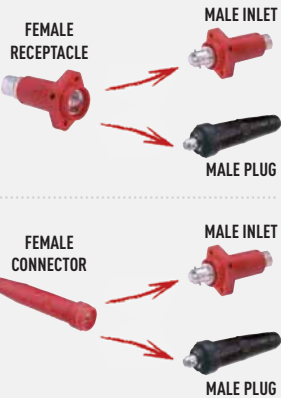

Receptacle (female) Lug Type Connection



Wiring Hole (in ²)	(mm ²)	Type 2 200A	Type 3 300A	Type 5 500A
.025	16	4-2401-A	-	-
.047	30	4-2401-B	-	-
.062	40	4-2401-C	-	-
.078	50	4-2401-D	4-3401-E	-
.116	75	-	4-3401-F	-
.155	100	-	4-3401-G	-
.186	120	-	-	4-5401-H
.233	150	-	-	4-5401-J

Inlet (male) Lug Type Connection



Wiring Hole (in ²)	(mm ²)	Type 2 200A	Type 3 300A	Type 5 500A
.025	16	4-2901-A	-	-
.047	30	4-2901-B	-	-
.062	40	4-2901-C	-	-
.078	50	4-2901-D	4-3901-E	-
.116	75	-	4-3901-F	-
.155	100	-	4-3901-G	-
.186	120	-	-	4-5901-H
.233	150	-	-	4-5901-J

Connector (female) Crimp/Solder Connection



Wiring Hole (in ²)	(mm ²)	Type 2 200A	Type 3 300A	Type 5 500A
.025	16	4-2301-A	-	-
.047	30	4-2301-B	-	-
.062	40	4-2301-C	-	-
.078	50	4-2301-D	4-3301-E	-
.116	75	-	4-3301-F	-
.155	100	-	4-3301-G	-
.186	120	-	-	4-5301-H
.233	150	-	-	4-5301-J

Plug (male) Crimp/Solder Connection



Wiring Hole (in ²)	(mm ²)	Type 2 200A	Type 3 300A	Type 5 500A
.025	16	4-0201-A	-	-
.047	30	4-0201-B	-	-
.062	40	4-0201-C	-	-
.078	50	4-0201-D	4-0301-E	-
.116	75	-	4-0301-F	-
.155	100	-	4-0301-G	-
.186	120	-	-	4-0501-H
.233	150	-	-	4-0501-J

LC – Battery Connectors



The periodic charging of batteries for many applications (including electric boats and material handling vehicles) requires frequent connector operations. In order to avoid current interrupting on the charging contacts, a pilot contact is generally used. The pilot contact is designed to break before the main contacts, thereby signalling the circuit breaker to function.

Meltric's LC battery connectors, are made with spring-loaded, silver-nickel butt style contacts, which are operated by means of a lever. This design ensures a superior electrical connection and the quick and easy operation of the device. The lever also provides a means of locking the units together to help prevent accidental disengagement. By contrast, many competitive battery charger connectors use sliding contacts. Because of how they operate, sliding contacts cannot provide the electrical performance, the durability or the quick breaking capabilities of Meltric's lever operated and spring-loaded, silver-nickel butt contacts.

General Ratings

- **Voltage**
50 to 750 VDC Max
50 to 690 VAC Max
- **Current Interruption Capability**
Not for current interrupting
- **Amperage**
75A - 200A
- **Pilot Circuit**
50V Max
- **Cable Termination**
Crimp/Solder
- **Contact Pressure**
19.8 lbs Min, 22.0 lbs Max
- **Contact Voltage Drop**
3.0 mV

Receptacle (female)

Plug (male)



Amperage	Lug I.D.		Wiring Capacity		2P 50V	2P+15A Pilot 50V	2P+G+15A Pilot 690VAC/750VDC*
	in	mm	AWG*	mm ²			
75A	.23	6.0	6	16	5-2105-A	5-2106-A	5-2107-A
100A	.32	8.2	3	30	5-2105-B	5-2106-B	5-2107-B
125A	.36	9.2	1	40	5-2105-C	5-2106-C	5-2107-C
150A	.43	11.0	1/0	50	5-2105-D	5-2106-D	5-2107-D
200A	.50	12.5	2/0	75	5-2105-K	5-2106-K	5-2107-K

Amperage	Lug I.D.		Wiring Capacity		2P 50V	2P+15A Pilot 50V	2P+G+15A Pilot 690VAC/750VDC*
	in	mm	AWG*	mm ²			
75A	.23	6.0	6	16	5-0205-A	5-0206-A	5-0207-A
100A	.32	8.2	3	30	5-0205-B	5-0206-B	5-0207-B
125A	.36	9.2	1	40	5-0205-C	5-0206-C	5-0207-C
150A	.43	11.0	1/0	50	5-0205-D	5-0206-D	5-0207-D
200A	.50	12.5	2/0	75	5-0205-K	5-0206-K	5-0207-K

* May vary depending upon the type of wire used
 • Pilot circuit is rated for maximum of 50V

Wiring Lug

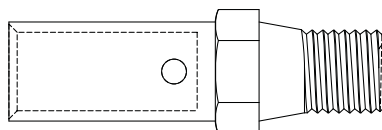
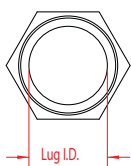

ADAPTER PLATES

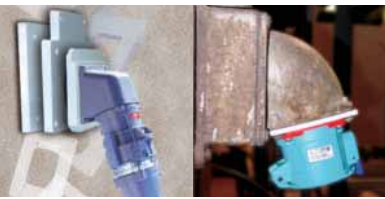

Adapter Plates



Updating your facility with Deconnector™ Series plugs and receptacles is simple and affordable with Meltric's adapter plates. They allow the mounting of Deconnectors to existing boxes previously used for competitive devices. This avoids the cost and hassle of installing new boxes and performing associated re-piping and rewiring. If an adapter plate for the box you have is not listed, contact customer service and Meltric will design a new one to fit your application.



Install Deconnectors on virtually any existing back box
No need to bend conduit or pull wires



Meltric Adapter Plates
Available for hundreds of competitive wall boxes, disconnect switches and mechanical interlocks



Meltric Receptacle

Meltric Part #	Meltric Devices	Description	Part Numbers Adapted to:		Meltric Part #	Meltric Devices	Description	Part Numbers Adapted to:		
CHARE36	DS30/DSN60 Recp/Inlet	<i>Appleton and Crouse-Hinds</i>	Appleton Crouse-Hinds					Appleton Crouse-Hinds		
			AEE36	ARE36				ARJG56		
	DS(N)37 Recp/Inlet	AEE46	ARE46	AR60						
		AEE56	ARE56	AR610						
	AERH36	ARRH36	AJ37							
	AERH46	ARRH46	AJ47							
	AERH56	ARRH56	AJ57							
	AERC36	ARRC36	AJ67							
	AERC46	ARRC46	AJA6							
	AERC56	ARRC56								
	AERA36	ARD36	Appleton Crouse-Hinds							
	AERA46	ARD46	CHARE56	DS60 Recp/Inlet				<i>Appleton and Crouse-Hinds</i>	AEE36	ARE36
	AERA56	ARD56							AEE46	ARE46
AJA310	ARJ36		DS100C Recp/Inlet		AEE56	ARE56				
AJA410	ARJ46				AERH36	ARRH36				
AJA510	ARJ56				AERH46	ARRH46				
AJA610	ARJG36				AERH56	ARRH56				
AJ100	ARJG46				AERC36	ARRC36				
					AERC46	ARRC46				

Meltric Part #	Meltric Devices	Description	Part Numbers Adapted to:	
			Appleton Crouse-Hinds	
CHARE56	DS60 Recp/Inlet	<i>Appleton and Crouse-Hinds</i>	AERC56	ARRC56
	DS100C Recp/Inlet		AERA36	ARD36
			AERA46	ARD46
			AERA56	ARD56
			AJA310	ARJ36
			AJA410	ARJ46
			AJA510	ARJ56
			AJA610	ARJG36
			AJ100	ARJG46
				ARJG56
				AR60
				AR610
				AJ37
				AJ47
			AJ57	
			AJ67	
			AJA6	
			Appleton Crouse-Hinds	
AJA100	DS100 Recp/Inlet	<i>Appleton and Crouse-Hinds</i>	AJA310	AR610
			AJA410	AJ37
			AJA510	AJ47
			AJA610	AJ57
			AJ100	AJ67
				AJC37
				AJC47
				AJC57
				AJC67
				AJA6
			Appleton Crouse-Hinds	
CHARE23	DS20/DSN30 Recp/Inlet	<i>Appleton and Crouse-Hinds</i>	AEE13	ARE13
	DS(IN)24 Recp/Inlet		AEE23	ARE23
			AEE33	ARE33
			AERH13	ARRC13
			AERH23	ARRC23
			AERH33	ARRC33
			AERC13	ARRH13
			AERC23	ARRH23
			AERC33	ARRH33
			AERA13	ARD13
			AERA23	ARD23
			AERA33	ARD33
				AR30
			ARJ13	

Meltric Part #	Meltric Devices	Description	Part Numbers Adapted to:	
			Appleton Crouse-Hinds	
CHARE23	DS20/DSN30 Recp/Inlet	<i>Appleton and Crouse-Hinds</i>		ARJ23
	DS(IN)24 Recp/Inlet			ARJ33
				ARJG13
				ARJG23
				ARJG33
			Appleton Crouse-Hinds	
CHARE33	DS30/DSN60 Recp/Inlet	<i>Appleton and Crouse-Hinds</i>	AEE13	ARE13
	DS(IN)37 Recp/Inlet		AEE23	ARE23
			AEE33	ARE33
			AERH13	ARRC13
			AERH23	ARRC23
			AERH33	ARRC33
			AERC13	ARRH13
			AERC23	ARRH23
			AERC33	ARRH33
			AERA13	ARD13
			AERA23	ARD23
			AERA33	ARD33
				AR30
			ARJ13	
			ARJ23	
			ARJ33	
			ARJG13	
			ARJG23	
			ARJG33	
			Appleton Crouse-Hinds	
CHAJ56-MA6	MP6	<i>Appleton and Crouse-Hinds</i>	AJA310	AJ37
	MA6	<i>without angle adapter</i>	AJA410	AJ47
	MS6		AJA510	AJ57
			AJA610	AJ67
			Appleton Crouse-Hinds	
CHFDADAPLT	09-20000-027-80	<i>FS/FD Single Gang Box</i>		
E462	61-10000-027	<i>FS/FD Single Gang Box</i>		
			RUSSELL STOLL	
DSN6JAA6	DSN60 Recp/Inlet	<i>Russell Stoll boxes</i>	JAA6-AB6	

ADAPTER PLATES

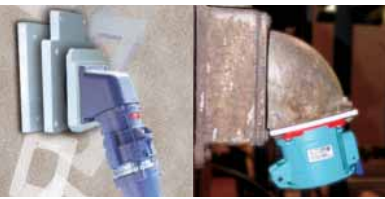

Adapter Plates

Meltric Part #	Meltric Devices	Description	Part Numbers Adapted to:	
RUSSELL STOLL				
DSN6JAA6	DSN60 Recp/Inlet	<i>Russell Stoll boxes</i>	JAA6-45	
			JRAA-AB6	
			JE6	
			JAAB6	
RUSSELL STOLL				
JRF60	DS60 Recp/Inlet	<i>Russell Stoll boxes</i>	JAA6-AB6	
	DS100C Recp/Inlet		JAA6-45	
			JRAA-AB6	
			JE6	
			JAAB6	
PNFS-DSN1-SS	PN/DSN2 Recp/Inlet	<i>FS/FD Single Gang Box</i>		
PNFS-DSN3-SS	DS/DSN3 Recp/Inlet	<i>FS/FD Single Gang Box</i>		
HUBBELL				
HH312	MA6	<i>Hubbell/60/100A Boxes</i>	26401	
	MP6		BB601W	
	MS6		BB602W	
			BB1001W	
			BB1002W	
			FW60100	
HUBBELL				
HH312-E448	DS60 Recp/Inlet	<i>Hubbell/60/100A Boxes</i>	26401	
	DS100C Recp/Inlet		BB601W	
			BB602W	
			BB1001W	
			BB1002W	
			FW60100	
KILLARK				
HH60K	DS60 Recp/Inlet	<i>Hubbell-Killark</i>	AJAE	
	DS100C Recp/Inlet	<i>Hazardous Duty Box</i>	AJAC	
			AJAT	
MAFS6BA	MA6	<i>FS /FD Single Gang Box</i>		
	MP6			
	MS6			
HUBBELL				
HHBB201W	DS1/DSN3 Recp/Inlet	<i>Hubbell / 20/30A Boxes</i>	BB201W	
			BB301W	
			FT202W	
			FT302W	
HUBBELL				
HBL26401	DS30/DSN60 Recp/Inlet	<i>Hubbell/60/100A Boxes</i>	26401	
			<i>60/100A Boxes</i>	BB601W
				BB602W
				BB1001W

Meltric Part #	Meltric Devices	Description	Part Numbers Adapted to:
HUBBELL			
HBL26401	DS30/DSN60 Recp/Inlet	<i>Hubbell/60/100A Boxes</i>	BB1002W
		<i>60/100A Boxes</i>	FW60100
HBL26401A	DS3/DSN6 Angle Adapter	<i>Hubbell/60/100A Boxes</i>	26401
HBL4200	DS200 Receptacle	<i>Hubbell 200A Boxes</i>	4200
HHB26401	DS60 Adapters	<i>Hubbell/60/100A Boxes</i>	26401
HH50	DS30/DSN60 Recp/Inlet	<i>Hubbell/lock/60A adapters</i>	26402
		<i>60A adapters</i>	26404
PNFS	PN/DSN20 Recp/Inlet	<i>FS /FD Single Gang Box</i>	
PYLE-NATIONAL			
PNFSPL	DS60 Recp/Inlet	<i>Pyle-National/60A Boxes</i>	JR-26046-A
	DS100C Recp/Inlet	<i>60A Boxes</i>	JR-36046-A
			JR-46046-A
			JR-56046-A
			JR-336046-C
			JR-446046-C
			JR-556046-C
			JR-26046-BB
PYLE-NATIONAL			
			JR-36046-BB
			JR-46046-BB
			JR-56046-BB
			JR-36046-BE
			JR-46046-BE
			JR-56046-BE
			JR-46046-CE
			JR-56046-CE
			JR-60-J
			JR-64-D
PYLE-NATIONAL			
PNJRBB30	09-20000-027-80	<i>Pyle-National</i>	JRW-13046-A
	MSPN	<i>20/30A Boxes</i>	JRW-23046-A
	MP2		JRW-33046-A
	MP3		JRW-113046-C
	MA2		JRW-223046-C
	MA3		JRW-333046-C
	MS2		JR-13046-BB
	MS3		JR-23046-BB
			JR-33046-BB
			JR-43046-BB
			JRW-13046-BE
			JRW-23046-BE
			JRW-33046-BE
			JR-23046-CE

Meltric Part #	Meltric Devices	Description	Part Numbers Adapted to:	Meltric Part #	Meltric Devices	Description	Part Numbers Adapted to:
			PYLE-NATIONAL				
PNJRBB30			JR-33046-CE				
			JR-62-CP				
			PYLE-NATIONAL				
PLN30	09-20000-027-80	<i>Pyle-National/60A Boxes</i>	JR-26046-A				
	MSPN		JR-36046-A				
	MP2		JR-46046-A				
	MP3		JR-56046-A				
	MA2		JR-336046-C				
	MA3		JR-446046-C				
	MS2		JR-556046-C				
	MS3		JR-26046-BB				
			JR-36046-BB				
			JR-46046-BB				
			JR-56046-BB				
			JR-36046-BE				
			JR-46046-BE				
			JR-56046-BE				
			JR-46046-CE				
			JR-56046-CE				
			JR-60-F				
			JR-64-D				
			PYLE-NATIONAL				
PLN60	MP6	<i>Pyle-National/60A Boxes</i>	JR-26046-A				
	MA6		JR-36046-A				
	MS6		JR-46046-A				
			JR-56046-A				
			JR-336046-C				
			JR-446046-C				
			JR-556046-C				
			JR-26046-BB				
			JR-36046-BB				
			JR-46046-BB				
			JR-56046-BB				
			JR-36046-BE				
			JR-46046-BE				
			JR-56046-BE				
			JR-46046-CE				
			JR-56046-CE				
			JR-60-F				
			JR-64-D				



Cord Grips

Poly Cord Grips



w/Metal Mesh



Aluminum Cord Grips



w/Aluminum Mesh



Handle NPT C	Cable Range B	Part # Cord Grip	Part # Cord Grip w/Mesh
1/2"	.312-.375	CG121P	CG121PM
1/2"	.375-.438	CG122P	CG122PM
1/2"	.438-.500	CG123P	CG123PM
1/2"	.500-.562	CG124P	CG124PM
1/2"	.562-.625	CG125P	CG125PM
3/4"	.438-.500	CG340P	CG340PM
3/4"	.500-.562	CG341P	CG341PM
3/4"	.562-.625	CG342P	CG342PM
3/4"	.625-.750	CG344P	CG344PM
3/4"	.688-.812	CG345P	CG345PM
1"	.660-.780	CG1001P	-
1"	.770-.895	CG1002P	-
1"	.870-1.020	CG1003P	-
1"	.890-1.090	CG1004P	-
1 1/4"	.890-1.090	CG1141P	-
* 1 1/4"	1.080-1.280	CG1142P	-
1 1/4"	1.270-1.470	CG1143P	-
1 1/4"	-	-	-
1 1/2"	.890-1.150	CG1121P	-
1 1/2"	1.140-1.400	CG1122P	-
1 1/2"	-	-	-
1 1/2"	-	-	-

Cable Range B	Part # Cord Grip	Part # Cord Grip w/Mesh
.312-.375	CG121A	CG121AM
.375-.438	CG122A	CG122AM
.438-.500	CG123A	CG123AM
.500-.562	CG124A	CG124AM
.562-.625	CG125A	CG125AM
.438-.500	CG340A	CG340AM
.500-.562	CG341A	CG341AM
.562-.625	CG342A	CG342AM
.625-.750	CG344A	CG344AM
.688-.812	CG345A	CG345AM
.750-.875	CG1001A	CG1001AM
.812-.938	CG1002A	CG1002AM
.875-1.000	CG1003A	-
-	-	-
.875-1.000	CG1141A	CG1141AM
1.000-1.125	CG1142A	CG1142AM
* 1.125-1.250	CG1143A	CG1143AM
* 1.250-1.375	CG1144A	CG1144AM
1.250-1.375	CG1121A	CG1121AM
1.438-1.562	CG1122A	CG1122AM
* 1.562-1.688	CG1123A	CG1123AM
* 1.688-1.812	CG1124A	CG1124AM

Notes: * Cable may have to be stripped to pass through the bore of the cord grip body (A)

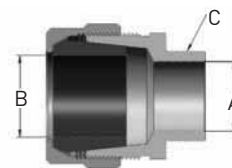

Cord Grip

Poly Cord Grips



w/Metal Mesh



Aluminum Cord Grips



w/Aluminum Mesh



Handle NPT C	Cable Range B	Part # Cord Grip	Part # Cord Grip w/Mesh
2"	1.190 - 1.530	CG2001P	-
2"	1.520 - 1.860	CG2002P	-
2"	1.850 - 2.190	CG2003P	-
2"	-	-	-
2"	-	-	-
2"	-	-	-
2 1/2"	-	-	-
2 1/2"	-	-	-
2 1/2"	-	-	-
3"	-	-	-
3"	-	-	-

Cable Range B	Part # Cord Grip	Part # Cord Grip w/Mesh
1.688 - 1.812	CG2001A	CG2001AM
1.812 - 1.938	CG2002A	CG2002AM
* 1.938 - 2.062	CG2003A	CG2003AM
* 2.062 - 2.188	CG2004A	CG2004AM
* 2.188 - 2.312	CG2005A	CG2005AM
* 2.312 - 2.438	CG2006A	CG2006AM
2.062 - 2.188	CG2121A	CG2121AM
2.188 - 2.312	CG2122A	CG2122AM
* 2.312 - 2.438	CG2123A	CG2123AM
2.437 - 2.625	CG3001A	CG3001AM
2.625 - 2.812	CG3002A	CG3002AM

Cable Size Reference Table

Cable Type/Size	Nominal Cable Dia.	Cable Type/Size	Nominal Cable Dia.	Cable Type/Size	Nominal Cable Dia.
16/2 SOW	0.37	8/5 SO	0.92	14/40 SOW	1.55
16/3 SOW	0.39	3/8 W	0.91	3/0 - 2 W	1.67
16/5 SOW	0.51	8/4 W	0.97	3/0 - 3 W	1.77
14/4 SOW	0.58	6/4 W	1.07	2/0 - 4 W	1.81
12/3 SOW	0.62	6/5 W	1.21	1/5 W	1.84
12/4 SOW	0.67	4/4 W	1.27	1/0 - 5 W	1.96
12/5 SOW	0.73	20/12 SOW	1.29	2/0 - 5 W	2.09
10/3 SOW	0.67	14/24 SOW	1.32	4/0 - 4 W	2.10
10/5 SOW	0.80	4/5 W	1.34	3/0 - 5 W	2.24
10/6 SOW	0.88	3/5 W	1.42	4/0 - 5 W	2.40
14/12 SOW	0.91	2/5 W	1.55		

PHASE ROTATION METER



Voltage / Phase Rotation Meter Assemblies

Voltage/Phase Rotation Meters offer customers an easy means of testing Meltric receptacles for voltage, as well as, motor rotation. The product consists of an inlet and handle wired to the meter. Smaller devices use standard nylon handles, while larger devices are provided with PH handles and cord-grips.



Order Example

The plug with voltage rotation meter assembly should be ordered to match the receptacles to be tested.



Existing 63-64043 receptacle



Matching plug with voltage phase rotation meter assembly 63-61043-MTR

Decontactor Inlet and Voltage/Phase Rotation Meter Assemblies DSN Series

Voltage	Polarity	Part # 20A	Part # 30A	Part # 60A
120/208V	3P+N+G	63-11167-MTR	63-31167-MTR	63-61167-MTR
125V	1P+N+G	63-11075-MTR	63-31075-MTR	63-61075-MTR
125/250V	2P+N+G	63-11076-MTR	63-31076-MTR	63-61076-MTR
208V	2P+G	63-11162-MTR	63-31162-MTR	63-61162-MTR
208V	3P+G	63-11163-MTR	63-31163-MTR	63-61163-MTR
250V	2P+G	63-11072-MTR	63-31072-MTR	63-61072-MTR
250V	3P+G	63-11073-MTR	63-31073-MTR	63-61073-MTR
277V	1P+N+G	63-11045-MTR	63-31045-MTR	63-61045-MTR
277/480V	3P+N+G	63-11047-MTR	63-31047-MTR	63-61047-MTR
347/600V	3P+N+G	-	63-31147-MTR	63-61147-MTR
480V	2P+G	63-11042-MTR	63-31042-MTR	63-61042-MTR
480V	3P+G	63-11043-MTR	63-31043-MTR	63-61043-MTR
600V	2P+G	-	63-31142-MTR	63-61142-MTR
600V	3P+G	-	63-31143-MTR	63-61143-MTR

DS Series

Voltage	Polarity	Part # 20A	Part # 30A	Part # 60A	Part # 100A	Part # 100A	Part # 200A
120/208V	3P+N+G	33-11167-MTR	33-31167-MTR	33-61167-MTR	33-61237-C-K16-MTR	33-91167-MTR	37-21167-MTR
125V	1P+N+G	33-11075-MTR	33-31075-MTR	33-61075-MTR	33-61175-C-K07-MTR	33-91075-MTR	37-21075-MTR
125/250V	2P+N+G	33-11076-MTR	33-31076-MTR	33-61076-MTR	33-61176-C-K07-MTR	33-91076-MTR	37-21076-MTR
208V	2P+G	33-11162-MTR	33-31162-MTR	33-61162-MTR	33-61232-C-K16-MTR	33-91162-MTR	37-21162-MTR
208V	3P+G	33-11163-MTR	33-31163-MTR	33-61163-MTR	33-61233-C-K16-MTR	33-91163-MTR	37-21163-MTR
250V	2P+G	33-11072-MTR	33-31072-MTR	33-61072-MTR	33-61172-C-K07-MTR	33-91072-MTR	37-21072-MTR
250V	3P+G	33-11073-MTR	33-31073-MTR	33-61073-MTR	33-61173-C-K07-MTR	33-91073-MTR	37-21073-MTR
277V	1P+N+G	33-11045-MTR	33-31045-MTR	33-61045-MTR	33-61245-C-K04-MTR	33-91045-MTR	37-21045-MTR
277/480V	3P+N+G	33-11047-MTR	33-31047-MTR	33-61047-MTR	33-61247-C-K04-MTR	33-91047-MTR	37-21047-MTR
347/600V	3P+N+G	33-11147-MTR	33-31147-MTR	33-61147-MTR	33-61187-C-K14-MTR	33-91147-MTR	37-21147-MTR
480V	2P+G	33-11042-MTR	33-31042-MTR	33-61042-MTR	33-61242-C-K04-MTR	33-91042-MTR	37-21042-MTR
480V	3P+G	33-11043-MTR	33-31043-MTR	33-61043-MTR	33-61243-C-K04-MTR	33-91043-MTR	37-21043-MTR
600V	2P+G	33-11142-MTR	33-31142-MTR	33-61142-MTR	33-61182-C-K14-MTR	33-91142-MTR	37-21142-MTR
600V	3P+G	33-11143-MTR	33-31143-MTR	33-61143-MTR	33-61183-C-K14-MTR	33-91143-MTR	37-21143-MTR

DB Series

Voltage	Polarity	Part # 30A	Part # 60A	Part # 100A
120/208V	3P+N+G	89-31167-MTR	89-61167-MTR	89-91167-MTR
125V	1P+N+G	89-31075-MTR	89-61075-MTR	89-91075-MTR
125/250V	2P+N+G	89-31076-MTR	89-61076-MTR	89-91076-MTR
208V	2P+G	89-31162-MTR	89-61162-MTR	89-91162-MTR
208V	3P+G	89-31163-MTR	89-61163-MTR	89-91163-MTR
250V	2P+G	89-31072-MTR	89-61072-MTR	89-91072-MTR
250V	3P+G	89-31073-MTR	89-61073-MTR	89-91073-MTR
277V	1P+N+G	89-31045-MTR	89-61045-MTR	89-91045-MTR
277/480V	3P+N+G	89-31047-MTR	89-61047-MTR	89-91047-MTR
347/600V	3P+N+G	89-31147-MTR	89-61147-MTR	89-91147-MTR
480V	2P+G	89-31042-MTR	89-61042-MTR	89-91042-MTR
480V	3P+G	89-31043-MTR	89-61043-MTR	89-91043-MTR
600V	2P+G	89-31142-MTR	89-61142-MTR	89-91142-MTR
600V	3P+G	89-31143-MTR	89-61143-MTR	89-91143-MTR

Notes: Only the voltage indication function will work for single phase devices. The rotation of the motor cannot be determined because only one phase is in use.

Contact customer service for price and availability of inlet and rotation meter assemblies not published here.

Accessories & Options

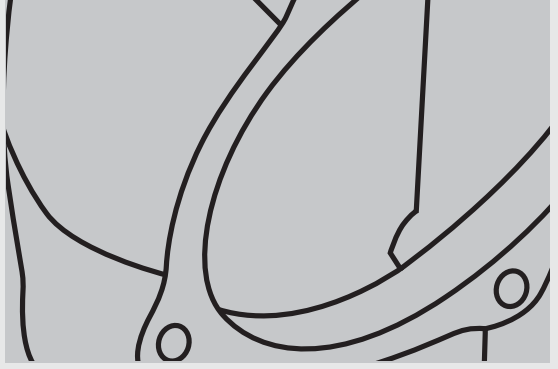
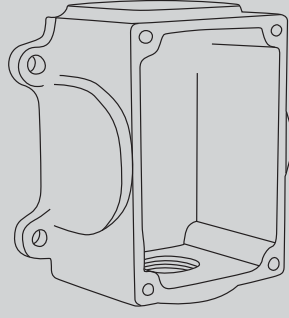
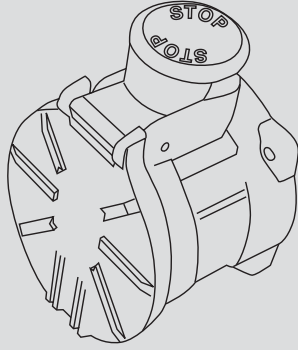
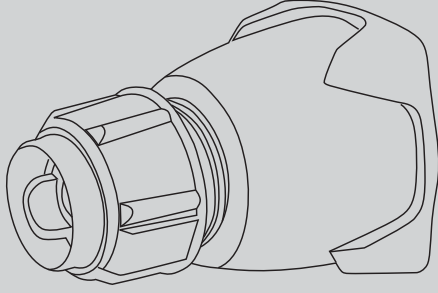

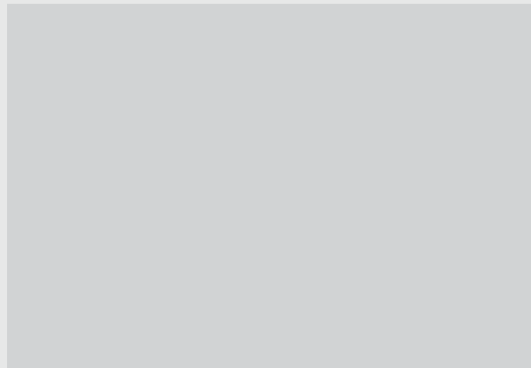
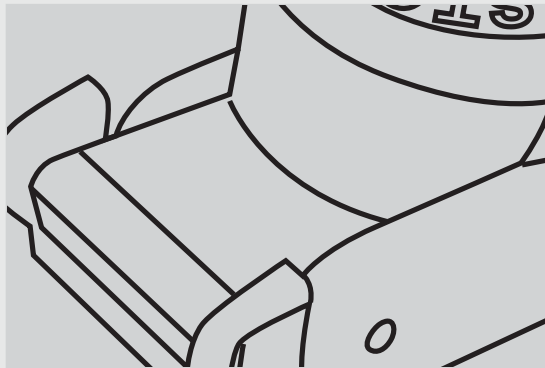
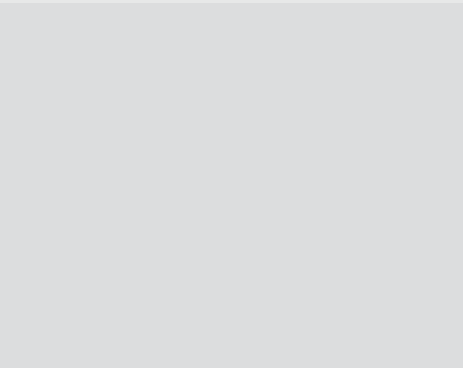

ACCESSORIES & OPTIONS

Auxiliary / Pilot Contacts	p. 199
Additional Watertightness	p. 200
Lid Configurations	p. 201
Plug Caps	p. 202
Pawl Options	p. 203
Auxiliary Switches	p. 204
Self-Ejecting Devices	p. 205

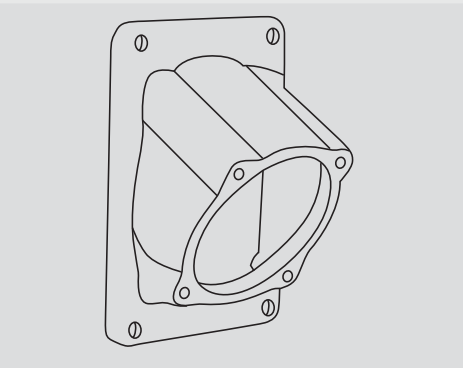

Auxiliary / Pilot Contacts

Auxiliary/pilot contacts can operate secondary circuits on the inlet or receptacle side of the circuit. They make last and break first when the plug is engaged or disengaged from the receptacle. To order a device with auxiliary/pilot contacts, add the appropriate suffix numbers listed to the right. Amperage ratings for the auxiliary/pilot contacts depend on the device size and operating voltage (see table below).

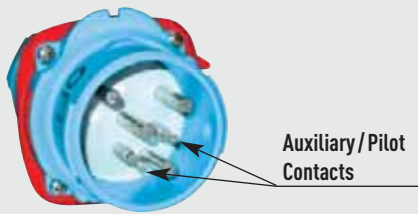

Decontactors with auxiliary/pilot contacts can make the operation of a facility safer and more efficient by facilitating the use of advanced control schemes. Decontactors with auxiliary/pilot contacts allow facilities to:

- ▶ **Quickly reconfigure or change-out processing equipment.**
The need for hard-wiring or multiple plug connections is eliminated.
- ▶ **Reduce equipment costs.**
The need for separate connections for the auxiliary/pilot contacts is eliminated.
- ▶ **Simplify the monitoring of key parameters.**
Thermistors on a motor driving a critical process pump can communicate temperature problems via auxiliary/pilot contacts in the Decontactor.
- ▶ **Communicate alarm signals or turn off equipment.**
When a motor is disconnected or unplugged, the auxiliary/pilot contacts can convey a signal that will de-energize the motor starter.

Auxiliary Contact Amperage Ratings

Product	120 VAC	240 VAC	480 VAC	600 VAC
DSN30, DSN60	6A	3A	1.5A	1.2A
DS20, DS30, DS60, DS100C	6A	3A	1.5A	1.2A
DS100 and DS200	3A	1.5A	0.75A	0.6A
DB30, DB60	6A	3A	1.5A	1.2A
DXN (All sizes)	5A*	5A*	5A*	5A (550V max)
PFQ300	7A	5A	2A*	2A*
PF (All sizes)	10A*	10A*	10A*	10A*
DR30, DR50, DR100	6A	3A	1.5A	1.2A
DR225, DR250	3A	1.5A	0.75A	0.6A
SP	0.6A*	0.3A*	-	-
SPeX	-	6A (220V max)*	-	-
DS7c	-	-	5A (400V max)*	-
DR7c	-	5A*	-	-

* Rating is not UL or CSA listed

Ordering Information

To order on a device, add the appropriate suffix to both the inlet and receptacle part numbers.

Product	2 Contacts	3 Contacts	4 Contacts	5 Contacts	6 Contacts
DSN30	-972	-	-	-	-
DSN60	-972	-973	-974	-	-
DS20	-972	-	-	-	-
DS30	-972	-973	-974	-	-
DS60/Poly	-972	-263	-	-	-
DS60/Metal	-972	-	-	-	-
DS100C/Poly	-972	-263	-	-	-
DS100C/Metal	-972	-	-	-	-
DS100	-262	-263	-264	-975	-976
DS200	-172	-173	-174	-175	-
DB30	-172	-	-	-	-
DB60	-172	-	-	-	-
DB100	-	-	-174	-	-
DXN30	-972	-	-	-	-
DXN60	-972	-	-	-	-
PFQ300	-	-	Standard (8)	-	-
PF300	-	-	Standard (4)	-	-
PF400	-	-	Standard (4)	-	-
PF600	-	-	Standard (4)	-	-
DR30	-972	-	-	-	-
DR50	-972	-973	-974	-	-
DR100/Poly	-972	-263	-	-	-
DR100/Metal	-972	-	-	-	-
DR150	-262	-263	-264	-975	-976
DR250	-172	-173	-174	-175	-
DS7c/DR7c	-172	-173	-	-	-
SP	Standard (2)	-	-	-	-



Replacement Contacts

Product	Male Pilot	Female Pilot
DSN30	31-1A011-30	31-1A021
DSN60	61-6A011-264	61-6A021-264
DS20	31-1A011-30	31-1A021
DS30	61-6A011-264	61-6A021-264
DR30	31-1A011-30	31-1A021
DR50	61-6A011-264	61-6A021-264

Additional Watertightness

For additional water protection when the inlet and receptacle are mated the following Type 4X option may be ordered for DS or DR models.



Type 4X Watertightness

Type 4X waterproofing is used for applications where connectors, plugs, and receptacles are subjected to water pressure. A gasket is added to the inlet and the receptacle lid is made to normally close.

Example:

To order on a device add suffix -4X to the inlet and receptacle part number.

DS20 Poly Inlet 2P + E = 33-18162-4X

To Order Separately...

Model	Type 4X Watertightness
DS20	31-1A056
DS30	31-3A056
DS60	31-6A066
DS100C	31-6A066
DS100	31-9A066
DS200	39-2A056
.....	
DR30	31-1A056
DR50	31-3A056
DR100	31-6A066
DR150	31-9A066
DR250	39-2A056

Lid Configurations

There are four standard open lid configurations depending on the model and size of the device: 180° open, 120° open, 90° open and detached. Optionally, customers can order lids that are normally closed, or if the lid opens to 120° as standard, it can be ordered to open 180° for flush mounted inlets (DS & DR only).

Standard Lid Configurations

180° opening lids



Standard for:

DSN20, DSN30, DSN60
 DS20, DS30, DS60, DS100C, DS100 poly
 DR30, DR50, DR100, DR150 poly
 DSDC1, DSDC3, DSDC6

120° Opening Lids



Standard for:

DX20, DX30, DX60, DX100
 DXN20, DXN30, DXN60

90° Opening Lids



Standard for:

DS100 metal, DS200
 DR150 metal, DR250
 DSDC9, DSDC2

Detached Lids

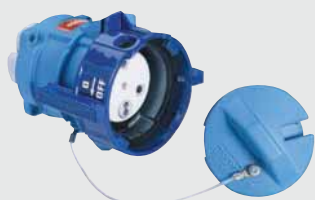

Standard for:

DB30, DB60, DB100
 PFQ300, PF300, PF400, PF600
 SP

Optional Lid Configurations

Closed Lid Configuration

Designed for female devices only. A normally closed lid configuration is available for applications where it is desirable to protect the receptacle face from dust, debris, or potential damage. This option provides a lid that will automatically close to a pre-latch position after removal of the plug. The lid must still be latched manually in order to achieve rated watertightness.



Available as option on:

DSN (All sizes)
 DS (All sizes)
 DR (All sizes)
 DN (All sizes, except DN7c)

Lid



Normally closed lid configuration is recommended for cord to cord applications to keep the lid tucked in and avoid damage.

Examples:

To order a DSN, DS, DR, or DN device with a closed lid add **-NC** to the receptacle part number

DS20 Poly receptacle 2P+G = 33-14162-NC

To order a DXN device with a closed lid add **-R** to the receptacle part number

DXN receptacle 2P+G = 22-14162-R

180° Open Lid for Flush Mounted Inlets (DS, DR & DXN devices only)

When ordering an inlet that will be mounted directly flush against a wall or surface without an angle or box, the connector (receptacle + handle) may require the lid to be set for 180° opening.



Available as option on:

DS100 metal, DS200
 DR150 metal, DR250
 DXN20, DXN30, DXN60

Example:

To order this configuration add suffix **-180** to the receptacle part number

DS100 Metal Receptacle 3P+N+G = 37-94047-180

Plug Caps

Protective Neoprene Plug Caps

Neoprene caps provide an extra level of protection from dust, dirt, and rough handling for male plugs.



Typical for DSN20 and DXN20 devices



Typical for DSN30 & DSN60, DS, DR, PN and DXN30 & DXN60



Typical for DB and DN devices

Ordering Information

Model	Neoprene Plug Cap
DSN20	61-1A426
DSN30	61-3A126
DSN60	61-6A126
DS20	31-1A126
DS30	31-3A126
DS60	31-6A126
DS100C	31-6A126
DS100	31-9A126
DS200	31-2A126
DB30	89-3A126
DB60	89-6A126
DB100	89-9A126
DXN20	61-1A426
DXN30	22-3A126
DXN60	22-6A126
DR30	31-1A126
DR50	31-3A126
DR100	31-6A126
DR150	31-9A126
DR250	31-2A126
DN9c	DN16R
DN20c	DN63R
DN7c (90A)	DN63R
DN7c (150A)	31-2A126
PN20	01-NA126



The lockout hole standardly provided on DSN, DS, DR and DXN plugs is not completely sealed off by the neoprene caps or the DS_PC and DS_MC caps. If environmental protection is needed while the plug is locked out, the inlet should be ordered without the standard hole. For DSN20 and DXN20, standard lockout hole is sealed by cap.

Example:

To order an inlet without a lockout hole add suffix **-A155** to the inlet part number.

DS20 Poly inlet 2P+G= 33-18162-**A155**

Padlockable Plug Caps

Padlockable caps can be locked in place to prevent unwanted removal.



Typical for: DSN20, DSN30, DSN60, DS20, DS30, DS60, DS100C, DR30, DR50



Typical for: DS60, DS100C, DS100, DS200, DR100, DR150, DR250

Ordering Information

Model	Padlockable Plug Cap
DSN20	61-1A826*
DSN30	61-3A826*
DSN60	61-6A826*
DS20	DS1PC (poly)
DS30	DS3PC (poly)
DS60	DS6MC (Alum)
DS100C	DS6MC (Alum)
DS100	DS9MC (Alum)
DS200	DS2MC (Alum)
DB30	-
DB60	-
DB100	-
DXN20	-
DXN30	-
DXN60	-
DR30	DS1PC (poly)
DR50	DS3PC (poly)
DR100	DS6MC (Alum)
DR150	DS9MC (Alum)
DR250	DS2MC (Alum)

* Maintains IP66+IP67 and NEMA 4X protection

Note: A 5/16" diameter lock/pin is needed for proper operation. Do not substitute a smaller diameter lock/pin.

Pawl Options

Mushroom Pawl

The mushroom pawl is available as an alternative to the standard pawl. It is ideal for a quick disconnection of motors and other equipment, or in areas where employees use gloves and it is difficult to operate the standard pawls. The button has a red “stop” label for easy recognition.

Example:

To order on a receptacle add suffix **-375** to the receptacle part number.

DSN20 poly receptacle 2P+G=63-14162-**375**



Available on:

DSN, DS, DR and DN devices only

Locking Mushroom Pawl

Locking mushroom pawls are available that include a screw which can be tightened to “lock” the pawl in place thus preventing release of the plug or the lid.

Example:

To order on a receptacle add suffix **-845** to the receptacle part number.

DS30 poly receptacle 3P+G =33-34163-**845**



Available on:

DSN, DS, DR and DN devices only

Padlockable Mushroom Pawl

A padlockable mushroom pawl can be provided with a .32” hole that enables the lid to be locked closed, prohibiting access to the receptacle.

Example:

To order on a receptacle add **-375-843** to the receptacle part number.

DS30 poly receptacle 3P+G = 33-38043-**375-843**



Available on:

DSN, DS, DR and DN devices only

Note: A 5/16” diameter lock/pin is needed for proper operation. Do not substitute a smaller diameter lock/pin.

Padlockable Standard Pawl

Standard pawls can be provided with a .32” hole that allows the lid of the receptacle to be locked closed or alternatively the plug can be locked in the connected position.

Example:

To order on a receptacle add suffix **-843** to the receptacle part number.

DSN20 poly receptacle 2P+G = 63-14162-**843**



Available on:

DSN, DS, DR and DN devices only

Note: A 5/16” diameter lock/pin is needed for proper operation. Do not substitute a smaller diameter lock/pin.

Metal Pawl

Metal pawls are standard with metal receptacles only. If you prefer a metal pawl on a poly receptacle, add suffix **-824** to the poly receptacle part number. Available on DS and DR devices only.

Example:

DS60 poly receptacle 3P+G=33-64163-**824**



Available on:

DS and DR devices only

Auxiliary Switches

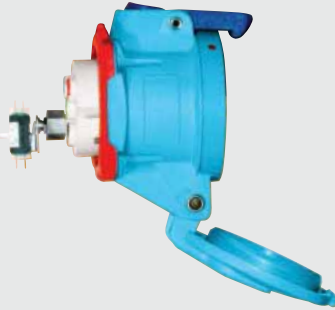

Female receptacles/connectors with up to 3 poles/4 wires are available with an optional auxiliary switch for operating secondary circuits on the line side of the circuit. The auxiliary switch is rated at 5A and includes one set of NO and one set of NC contacts. With the three phase devices the neutral contact of the plug operates the switch which is located in the neutral contact position in the receptacle. With the single phase units the third phase contact on the plug operates the switch which is located in the third phase contact position in the receptacle.

Auxiliary switches are available on:

DSN Series – DSN30 and DSN60 only

DS Series – All Sizes

DR Series – All Sizes

Examples:

Order a receptacle with an auxiliary switch by adding suffix **-270** to the receptacle part number

DSN30 Poly Receptacle 3P+G = 63-34043-**270**

If the receptacle is 3 pole/4 wire, the mating plug must be ordered as a 4 pole/5 plus the suffix **-NNF** should be added.

DSN30 Poly Inlet 3P+N+G = 63-38047-**NNF**

If the receptacle is 2 pole/4 wire (with neutral) the mating plug must be ordered as a 4 pole/5 wire and the suffix **-3NF** must be added.

DSN30 Poly Inlet 2P+N+G = 63-38076-**3NF**

Notes: Devices ordered with auxiliary switch option are not UL/CSA listed.

Self-Ejecting Devices

Self-ejecting devices are designed to automatically release the plug or connector when tension is detected, thus protecting the equipment from damage caused when mobile equipment is accidentally moved without disconnecting the power. The self-ejecting system is activated by a tension cord attached between the pawl and power cable.

Applications for the self ejecting option include: truck hook-ups, cranes, railroad cars or portable equipment such as refrigerated food carts.

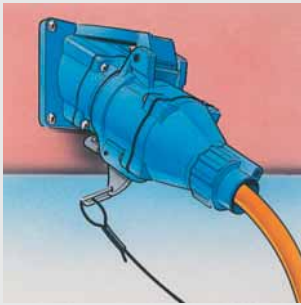

A tension cord is attached to the power cable and the fin pawl of the plug.

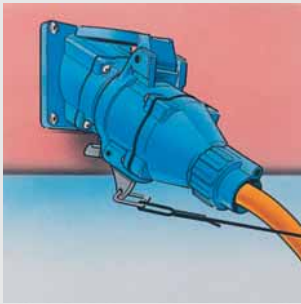

Tension on the power cable will automatically lift the fin pawl via the tension cord.

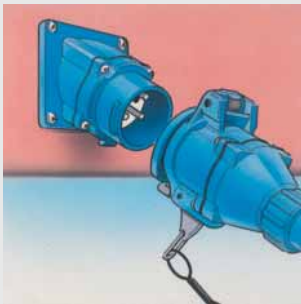

Once the fin pawl is lifted, the plug pulls away from the receptacle.

WARNING Weight of cable assemblies can cause damage to units when released and dropped to the ground.



DS20 plug and receptacle fitted with a shark's fin ejecting mechanism



DS200 plug and receptacle fitted with a cam mechanism that ejects the plug when the cable is pulled.

Notes: Self-ejecting devices are modified to allow straight insertion. This defeats the safety shutter and voids the devices switch ratings.

Self-Ejecting Plug



Principle of Operation:

A cam or shark's fin mechanism is used to lift the pawl on the receptacle thus releasing the plug when a tension is applied to the power cable.

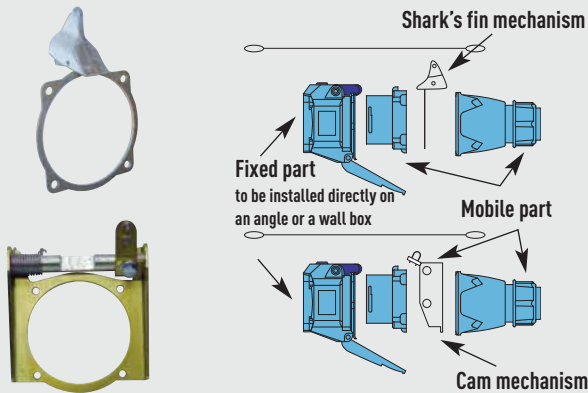

Sharks fin mechanism is provided on: Cam mechanism is provided on:

DSN20, DSN30, DSN60

DS100, DS200

DS20, DS30, DS60, DS7

DN9c, DN20c

DN7c, DN9c, DS24c, DS37c, DSN24c, DSN37c

How to Order:

To the male inlet add suffix **-338-A188**

To the female receptacle add suffix **-A188**

To the handle part number add suffix **-CG**

Example:

To order a 6P DN9c/20cA with a nylon handle and metal angle, the part numbers would be:

Inlet: 19-18060-**338-A188**

Receptacle (straight insertion): 19-14060-**A188**

Handle: FH311-**CG**

Angle: MA3

Installation Instructions:

The cable guide plate is to be assembled between the cord grip and the back of the handle, with the tension cord threaded through the cable guide plate. Create a slight amount of slack in the power cable, approximately 2' back from the handle. Fasten the tension cord securely to the power cable, making sure the tension cord has less slack than the power cable.

Self-Ejecting Female Connector



Principle of Operation:

The standard pawl on the connector is replaced by a "shark's fin" pawl which is attached to the power cable by a tension cord. If the connected equipment is moved, the tension cord lifts the sharks fin pawl and the connector is released before damage can occur.

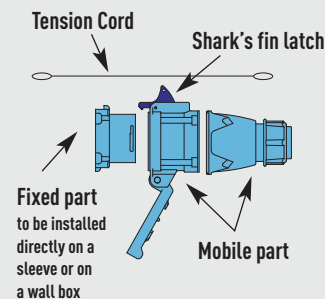

Available on:

DSN (All sizes)

DS and DR (All sizes)

DN (All sizes)

How to Order:

To the male inlet add suffix **-A188**

To the female receptacle (DS, DN), add suffix **-348-A188**

To the female receptacle (DSN), add suffix **-345-A188**

To the handle part number add suffix **-CG**

Example:

To order a 6P DN9c/20cA with a nylon handle and metal angle, the part numbers would be:

Inlet (straight insertion): 19-18060-**A188**

Receptacle: 19-14060-**348-A188**

Handle: FH311-**CG**

Angle: MA3

Installation Instructions:

Create a slight amount of slack in the power cable adjacent to the handle. Fasten the tension cord securely to the power cable, making sure the tension cord has less slack than the power cable.

Notes: For plug-connector cord sets, it is recommended to order both a self-ejecting plug and a self-ejecting female connector. When used on a device with finger drawplates, the drawplates need to be rotated 180°.

Technical Manual

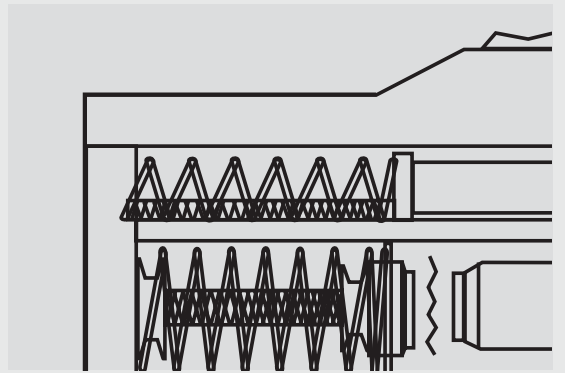
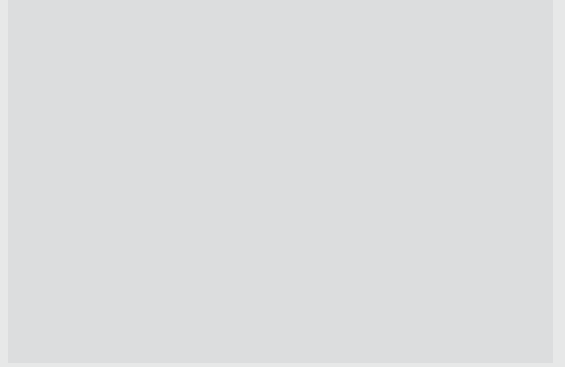
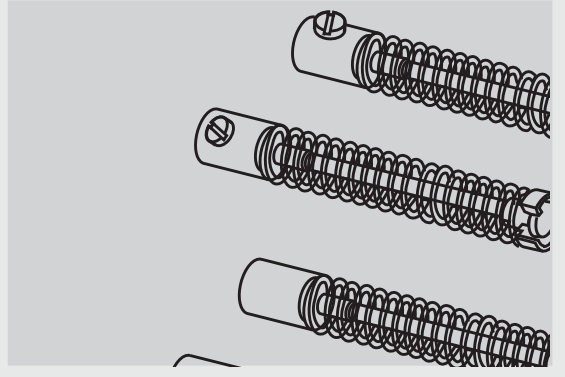
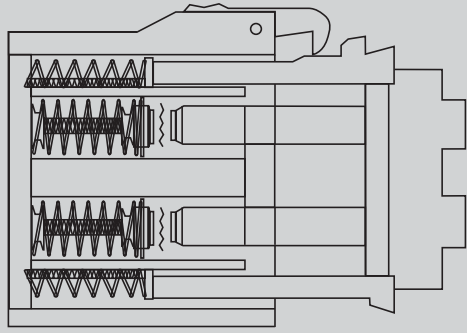

NEMA 4X

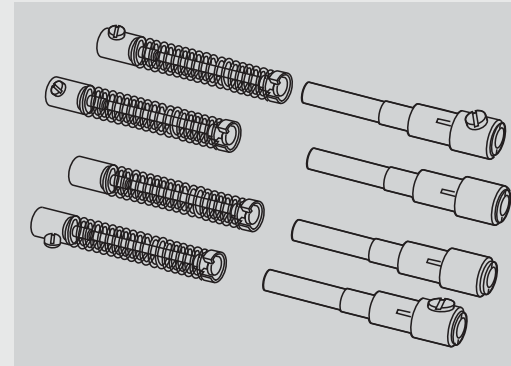
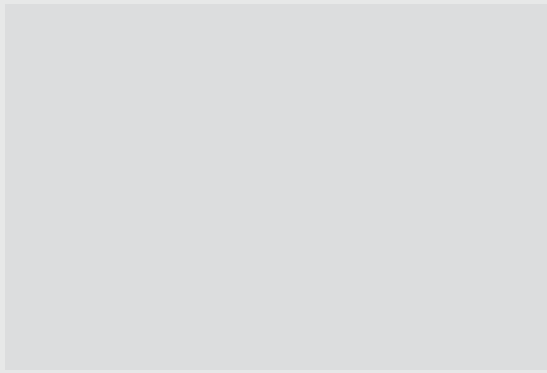

TECHNICAL MANUAL

Switch Ratings vs Current Interrupting Ratings	p. 209
Electrical Performance	p. 210
Butt-Contact Technology	p. 213
Dead-Front Construction	p. 215
Keying System	p. 216
Dual Voltage Devices	p. 216
Resistance to Environments and Chemicals	p. 217
Watertightness/Ingress Protection	p. 219
Impact Resistance	p. 220
Operating Temperatures	p. 220
Color-Coded Gaskets & Labels	p. 221

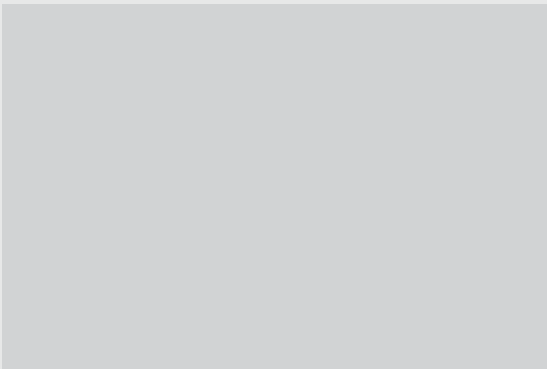

Electrical Performance – Switch Rated, Current Interrupting Rated and Non-Current Interrupting Rated Devices

Switch Rated Plugs & Receptacles

Meltric’s Decontactor™ Series products are UL & CSA listed as switch rated plugs and receptacles. These ratings allow them to be used as a motor circuit disconnect switch, as well as a branch circuit disconnect switch. Switch rated plugs and receptacles have passed electrical overload, short circuit and endurance tests that are far more rigorous than those applied to other plugs and receptacles. These tests include the functional requirements for safety disconnect switches in addition to manual motor controllers. For more information about the tested electrical performance of switch rated devices consult pages 210 - 212.

Current Interrupting Rated Plugs & Receptacles

Other Meltric devices such as the DXN plugs and receptacles are UL and/or CSA rated for “current interrupting”. A current interrupting rated plug and receptacle is not subjected to the same level of endurance testing as a switch rated device and does not need to be subjected to any overload-locked rotor or short circuit testing (see pages 200 - 202 for performance test comparisons). Plug and receptacles rated for “current interrupting” are not intended to be used as switches, but can withstand making and breaking of normal resistive loads. Devices that are not hp and short circuit rated are not intended to make and break motor loads or other inductive loads.

Non-Current Interrupting Rated Plugs & Receptacles

Many competitive plugs and receptacles, as well as some Meltric devices are “non-current interrupting” rated. They are not approved by UL or CSA for connecting or disconnecting under load. They have passed the minimum test requirements for plugs and receptacles but they have not passed current interrupting performance tests or the more demanding electrical endurance, overload and short circuit tests required of switch rated devices. For more information about the tested electrical performance of non-current interrupting rated devices consult pages 210 - 212.

Ratings	Product
Switch Rated	DSN
	DS
	DB
Current Interrupting Rated	DXN
	Multipin
	DR
	PN
	DX
	Competitors Pin and Sleeve
Non-Current Interrupting Rated	Multipin
	PF/PFQ
	DSDC
	Competitors Pin and Sleeve

Note: DXN37c, PXN12c, and SPeX hazardous duty devices are not to be connected or disconnected while the circuit is energized.

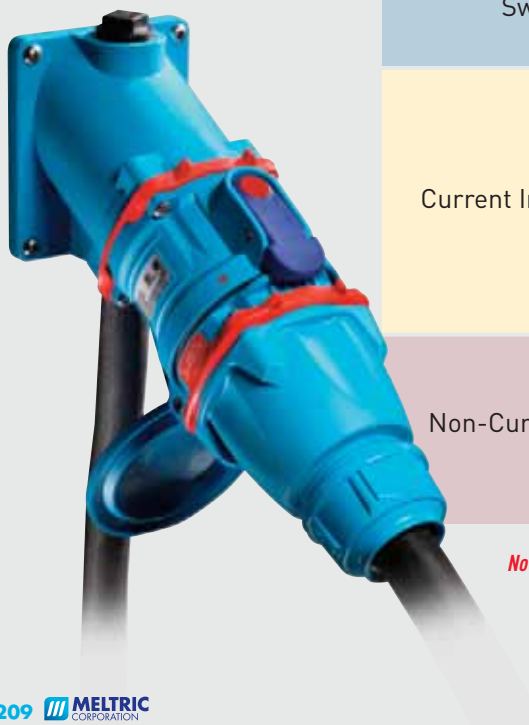

Electrical Performance

Overload Conditions

UL & CSA standards for plugs and receptacles require that the devices be able to withstand overload conditions. General use conditions are simulated by testing a device to a specified number of operations (50) at 150% of rated current and a power factor between 0.75 and 0.80. Switch rated plugs and receptacles that are horsepower rated must perform overload testing at 600% of full load motor current with a more severe power factor (between 0.40 and 0.50) to simulate locked rotor conditions.

UL & CSA Standards – Overload Test Requirements and Ratings Comparisons

Test	UL 1682 & CSA 22.2 No. 182.1		UL Subject 2682 (used for both UL & CSA listings)
	Plugs, Receptacles & Cable Connectors of the Pin & Sleeve Type		Switch Rated Plugs & Receptacles
	Non-Current Interrupting (Typical)	Current Interrupting (Typical)	Motor / Branch Circuit Switch Rated (Typical)
Overload (General Use Devices)	3 Operations @ 150% of Rated Current (p.f. = .75 - .80)	50 Operations @ 150% of Rated Current (p.f. = .75 - .80)	50 Operations @ 150% of Rated Current (p.f. = .75 - .80)
Overload - Locked Rotor (Horsepower Rated Devices)	-	-	50 Operations @ 600% of Full Load Motor Current (p.f. = .40 - .50)

• The overload requirement for testing DC devices is 1 operation.

Test Results: Completed Operations at Overload/Locked Rotor Condition

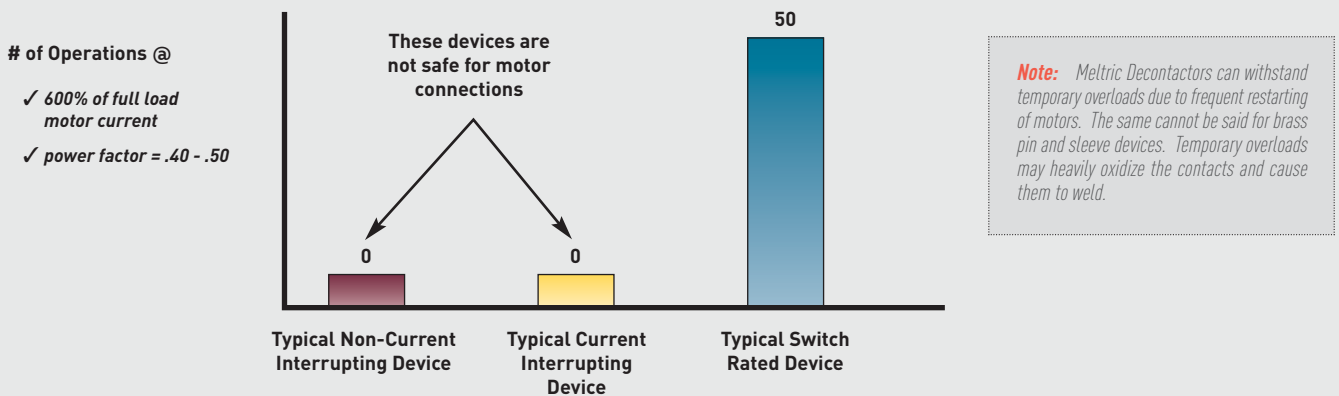

Motors and other equipment can be quickly and safely connected or disconnected with Meltric's Switch Rated DECONTACTOR™ Series plug and receptacles.

Electrical Performance

Mechanical and Electrical Endurance

UL and CSA standards require endurance testing to ensure that rated performance is maintained over the expected life of the device. The severity of this testing depends on the rating of the device.

As shown in the chart below, non-current interrupting devices are tested only for mechanical endurance. Current interrupting devices are additionally subjected to moderate electrical endurance testing, and switch rated devices are subjected to a much more severe level of electrical endurance testing, which is similar to that required of disconnect switches. In this regard, switch rated devices may be required to make and break under full load more than 20 times as many operations (depending upon device amperage) as a current interrupting rated pin and sleeve device.

UL & CSA Standards – Endurance Test Requirements and Ratings Comparisons

Test	UL 1682 & CSA 22.2 No. 182.1		UL Subject 2682 (used for both UL & CSA listings)
	Plugs, Receptacles & Cable Connectors of the Pin & Sleeve Type		Switch Rated Plugs & Receptacles
	Non-Current Interrupting	Current Interrupting	Motor / Branch Circuit Switch Rated
Mechanical Endurance (no load)	15-20A = 5000 Operations 21-63A = 2000 Operations 64-250A = 250 Operations	15-20A = 0 Operations 21-63A = 1000 Operations 64-250A = 500 Operations	6000 Operations (Covered by Electrical Endurance testing)
Electrical Endurance (With Load)	-	15-20A = 5000 Operations 21-63A = 1000 Operations ¹ 64-250A = 250 Operations ¹ @ Rated Current & Voltage (p.f. = .75 - .80)	6000 Operations @ Rated Current & Voltage (p.f. = .75 - .80)

Notes: ¹ Testing alternates between mechanical & electrical operations. This reduces the severity of the electrical test by allowing additional cooling time during electrical testing.

Electrical Endurance Test Comparison

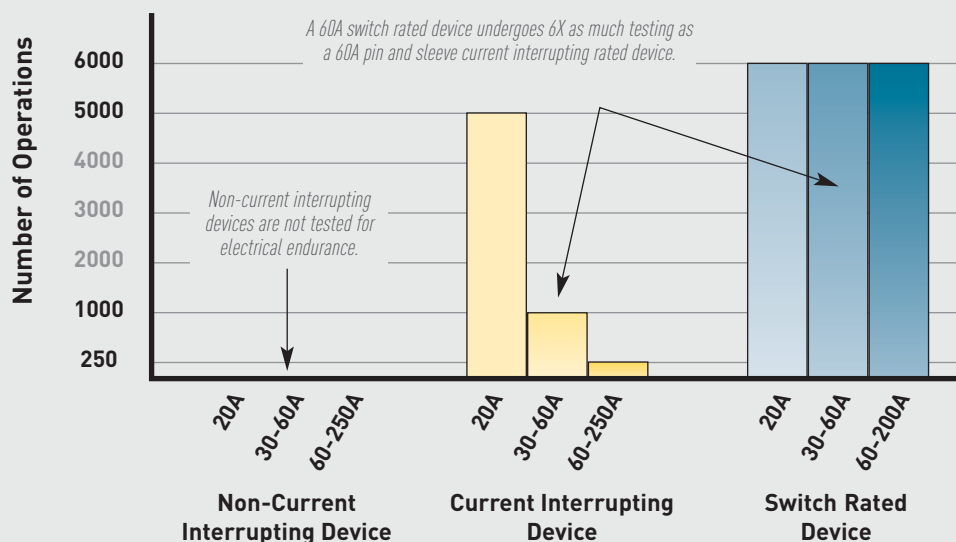

Electrical Performance

Short Circuit Protection

Meltric's Decontactors (DS, DSN, and DB products) have successfully completed high fault current short circuit testing. All these devices have short circuit make (close) and withstand ratings of either 65 kA or 100 kA. UL witnessed and approved this testing.

UL Recognized Short Circuit Capabilities

UL Recognized Short Circuit Capabilities			
Plug & Receptacle Type	Short Circuit Ratings		Product Standard
	Withstand	Make	
General Use Pin & Sleeve Devices	None	None	UL 1682
HP Rated Twist-Type Devices	1kA	None	UL 498
Motor Rated Pin & Sleeve Devices	10kA	None	UL 1682
Meltric Decontactors	≥ 65kA	≥ 65kA	UL Subject 2682

Short Circuit Test Information

Fusing – The amperage and time delay characteristics of the fusing used in testing affects the electrical load seen by the device. UL Subject 2682 requires short circuit tests be performed with fuses having an amperage rating that is no less than 400% of full load motor ampacity for horsepower rated devices, or no less than 100% of the device's amperage rating for general use devices.

Meltric used RK1 non-time delay type fusing for the horsepower rated devices because it is a common type of fuse used in motor applications. Meltric selected RK5 Time Delay fusing for the non-horsepower rated devices (DS9 & DS2) because it represents the most severe case of the various fusing scenarios that are typically used for general use applications.

Power Factor – The lower the power factor (p.f.) the more rigorous the test. UL Subject 2682 requires short circuit testing at 42,000 amps and above to be performed with a p.f. of 0.15 or less. By comparison, the p.f. for the 10,000 amp short circuit withstand test required by UL 1682 for horsepower rated plugs & receptacles, is a much less rigorous 0.50.

Short Circuit Test Summary Table

Device Information			Short Circuit Make & Withstand Rating ¹			
Model	General Use Rating	Max Motor FLA ¹	kA	VAC	Fusing used in Testing	
DSN20	20A	8A (2 hp @ 208 VAC)	100	480	RK1	35A
DSN30	30A	18A (15 hp @ 600 VAC)	100	600	RK1	125A
DSN60	60A	27A (20 hp @ 480 VAC)	100	600	RK1	110A
DS20	20A	11A (3 hp @ 208 VAC)	100	600	RK1	80A
DS30	30A	14A (10 hp @ 480 VAC)	100	600	RK1	125A
DS60	60A	27A (25 hp @ 600 VAC)	100	600	RK1	250A
DS100C	100A	27A (25 hp @ 600 VAC)	100	600	RK1	250A
DS100	100A	-	65	600	RK5 TD	100A
DS200	200A	-	65	600	RK5 TD	200A
DB30	30A	26A (7.5 hp @ 208 VAC)	100	600	RK1	125A
DB60	60A	49A (15 hp @ 208 VAC)	100	600	RK1	250A
DB100	100A	92A (30 hp @ 208 VAC)	100*	600	RK1	250A*

¹ The maximum associated with any of the devices horsepower ratings. The fusing used in the short circuit testing must be at least 400% of this value in order for the short circuit rating to apply to the hp rating.

* The fusing used limits the 100kA rating to 60hp @ 600V, 40hp @ 480V, 20hp @ 240V & 208V

Contact Technology

Meltric products feature silver-nickel, spring-loaded butt contacts similar to those used in motor starters and contactors.

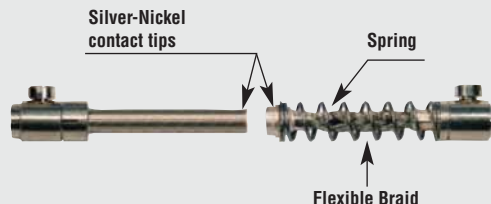

Silver-Nickel Contact Material

Meltric uses solid silver-nickel (85%/15%) contacts. The silver-nickel material has significant advantages over the brass contacts commonly used on competitive devices.

Silver has very low initial contact resistance and is not negatively affected by oxidation. This helps to give it excellent electrical properties that are maintained even at high temperatures and after tarnishing. Nickel is a much harder material and contributes excellent mechanical properties. The combination of silver and nickel results in a contact material that has both superior electrical capabilities and excellent resistance to wear. Silver-nickel only welds at extremely high pressure and temperature, and thus, also withstands arcs very well. These features make silver-nickel a commonly used contact material by switchgear manufacturers.

By contrast, the brass material used in most competitive plugs and receptacles has much higher initial contact resistance and is negatively affected by oxidation. In an oxidized state, the contact resistance of brass is more than 20 times higher than that of silver-nickel. In addition, brass is a soft material that wears rapidly. In use, brass pin and sleeve and arcuate contacts suffer from the combined effects of the limitations of the material and the design. As oxidation and wear induced reductions in contact force occur, contact resistance increases. This increases operating temperature, which causes further oxidation and wear, perpetuating a vicious cycle of degradation. Brass is not arc resistant and is not suitable for making and breaking under load.

MATERIAL	CONTACT	RESISTANCE
	NEW	OXIDIZED
SILVER	6 $\mu\Omega$	25 $\mu\Omega$
SILVER-NICKEL	23 $\mu\Omega$	60 $\mu\Omega$
COPPER	29 $\mu\Omega$	400 $\mu\Omega$
BRASS	370 $\mu\Omega$	1400 $\mu\Omega$

In an oxidized state, silver-nickel is 20 times more conductive than brass.

Spring-Loaded Contacts

Spring-loading of the contacts ensures that optimal pressure between the contacts is maintained – even after tens of thousands of operations. This point is important because contact force is a key determinant of the quality of the connection. As the accompanying graph demonstrates, contact resistance increases as contact force decreases. Higher contact resistance generates more heat and oxidation, both of which contribute to the deterioration of the contact. This is a problem with pin and sleeve and arcuate type contacts because their contact force varies with manufacturing tolerances and is reduced due to wear that occurs with normal use.

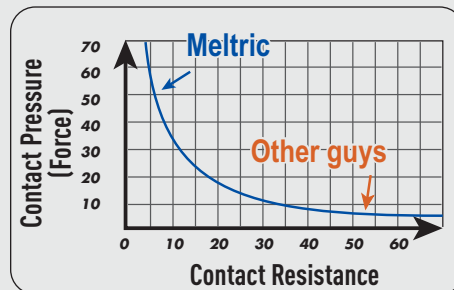

Higher contact pressure leads to lower contact resistance.

Butt-Style Connection

Meltric's butt-style contact configuration provides a positive and secure connection and also makes connection and disconnection easy. With butt contacts, the force applied to the contacts is in-line with the insertion motion, so inserting a plug into its socket requires only a known and limited amount of effort. Contact wear and sensitivity to manufacturing tolerances is negligible, because the spring-loading is sufficient to compensate for minor differences in contact length.

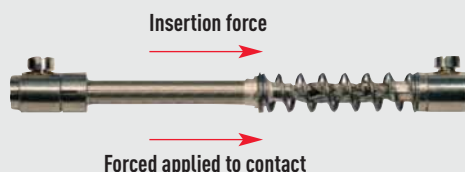

With Meltric's butt contacts the force applied to the contacts is in-line with the insertion motion.

With the pin and sleeve design used by our competitors, the contact force is at a right angle to the insertion/withdrawal force. There are numerous drawbacks to such a design:

- ▶ The contact pressure must be sufficient to prevent excessive temperature rise but is limited by the need to keep the insertion force reasonable.
- ▶ The necessary friction wears out the contacts, and diminishes contact pressure over time.
- ▶ Normal manufacturing tolerances result in wide variations in performance, even with new devices.
- ▶ The sliding contact design does not make & break cleanly, so arcing is more likely to occur.

Quick Break Mechanism

On most Meltric devices, the circuit is broken simply by depressing the pawl. Doing so releases the energy in a spring-loaded operating mechanism, which instantaneously breaks the circuit and ejects the plug to the 'OFF' position. Contact breaking time is about 15 milliseconds. The quick break mechanism is automatically reloaded when the plug is re-inserted.

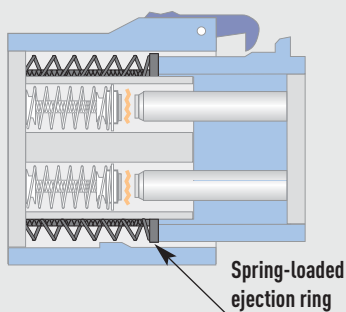

Spring-loaded ejection system ensures a quick break of the contacts.

In contrast, the disconnection speed of pin and sleeve and twist type devices is dependent on the users motion when removing the plug.

Self-Cleaning System

Meltric contacts close with a self-cleaning, wiping action. When the contacts initially mate, they are slightly offset. In completing the connection, the plug contacts are rotated partially across the receptacle contacts, helping to remove deposits from the contact surface.

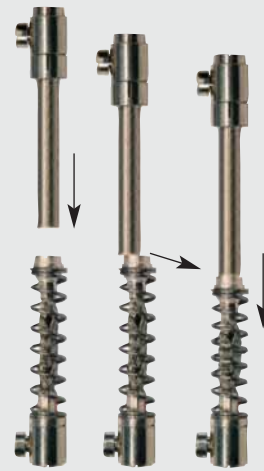

Meltric contacts are self cleaning.

Contact Mating Sequence

Decontactor contacts mate in a specific sequence to ensure a proper and safe connection.

1. The earth (ground) closes first
2. Then the neutral,
3. Then the phases,
4. Then the auxiliary contacts, if any. These auxiliary contacts can, therefore, be used as "pilot" contacts.

On opening, the sequence is reversed.

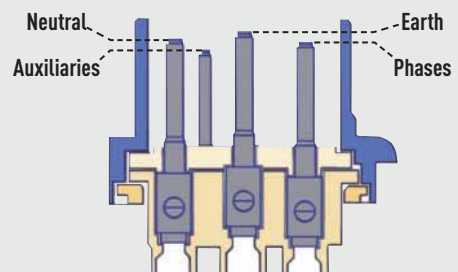

The contacts are set in the plug at different levels to achieve the desired mating sequence.

Dead Front and Enclosed Arc Chambers

For Maximum Protection from Live Parts

Most Meltric receptacles feature a dead front which encloses and isolates the live contacts when the plug is removed. Only electrically compatible plugs can unlock the safety shutter and gain access to the live parts. In addition to preventing accidental exposure to live parts, the safety shutter also keeps the contacts clean and out of reach even if the lid is left open.



The receptacle's dead front protects workers from accidental tool and wire insertion.

Protection During the Making and Breaking Process

When disconnecting or connecting a Meltric plug from/to a receptacle, the user is completely protected from exposure to arc flash or live parts. This is because the contacts can only make or break while they are enclosed in internal arc chambers within the receptacle.

During disconnection, the pressing of the pawl on the receptacle breaks the connection (inside the arc chambers) and ejects the plug to its rest or "OFF" position. While in the rest position, the plug and receptacle casings maintain a dead front and thus protect the user from live parts. The plug can not be fully withdrawn until it is rotated 30° counterclockwise. This closes and locks the safety shutter preventing access to live parts during and after the removal of the plug.

During connection, the plug contacts can only access the receptacle contacts after the plug has been partially inserted into the receptacle and has then been rotated 30° to open the safety shutter. Because the interaction of the skirted plug casing with the receptacle forms a protective enclosure that prevents access to the contacts as soon as insertion begins, a dead front is maintained even after the safety shutter is opened. Once the safety shutter has been opened, can the plug contacts be safely inserted into the arc chambers where the connection is made as the plug is latched to the receptacle.

Note: *Coding Disk* Some receptacles utilize a coding disk which performs the same functions as does the one piece safety shutter.

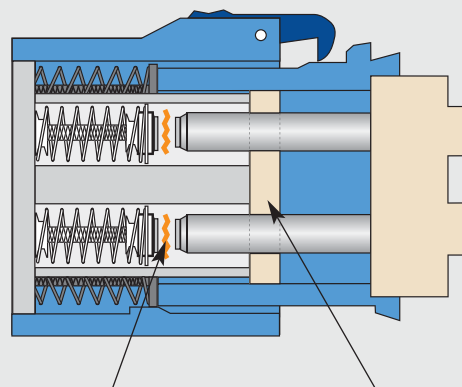

Arc chamber prevents outside exposure to arc flash.

Safety shutter prevents finger or tool access to live parts.

Protection from Insertion of Inappropriate Plugs

Meltric products offer up to 24 different keying positions. Only plugs and receptacles that are keyed/notched in the same positions will mate with each other. Non-compatible plugs will be unable to open the safety shutter. This system prevents potentially dangerous situations. For example, a 250VAC plug (notch 07) can not be inserted into a 480VAC receptacle (notch 04). Alternatively, on the PF and DX series, pegs and holes perform the same function as the notches.

Note: *Some of the keying positions have been assigned to a designated global voltage. A few others are unassigned and are available if a user prefers to limit mating of plugs and receptacles that are only to be used on particular applications.*

Commonly Used Keying Positions

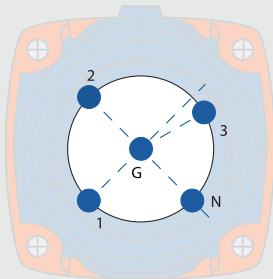

Position 04

255-277VAC/440-480VAC 60Hz

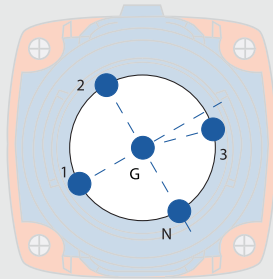

Position 07

110-125/220-250VAC 50Hz

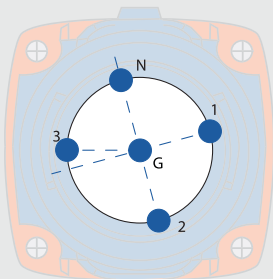

Position 14

347/600VAC 60Hz

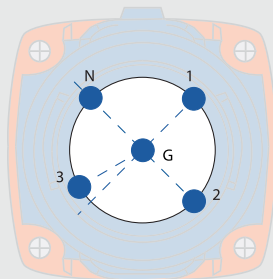

Position 16

120-127VAC/208-220VAC 60Hz

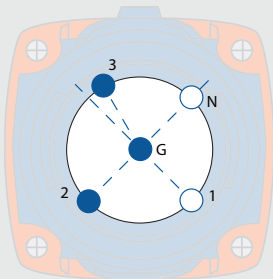

Position 10

110-130VDC

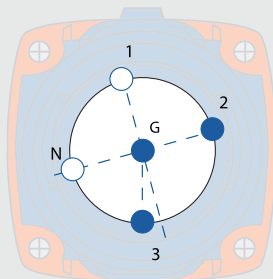

Position 20

220-250VDC

Note: See chart on page 15 for a complete list of voltage polarization positions and associated voltages.

How to Identify Keying Positions of an Existing Device

Plug

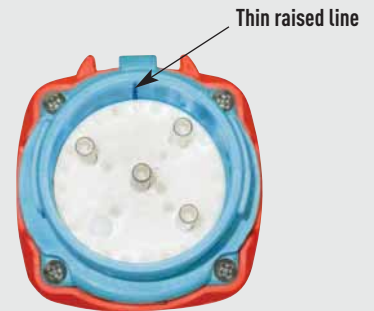

The keying position of most Meltric plugs can be determined by looking at the plug interior and finding a thin, raised line in the casing. This line is always directly above a number that identifies the plug's keying position.

Receptacle



The keying position for most receptacles can be determined by identifying a raised arrowhead (usually on the pawl or on the casing next to the pawl). This arrow points to a key number that can be found on the ring that surrounds the safety shutter.

Dual Voltages Devices Maximize User Flexibility

Some Meltric receptacles are designed to safely allow dual voltage capabilities.

For example, a 208V rated 3P+N+G receptacle will safely provide power to several configurations of 208V plugs and a single phase 120V plug. Having two voltages delivered by a single receptacle allows some facilities to significantly reduce the number of receptacles that need to be installed.

Dual voltage receptacles are supplied with dual color coded voltage stickers.

Dual Voltages Typically Available from Meltric

125/250V

120/208V

277/480V

347/600V

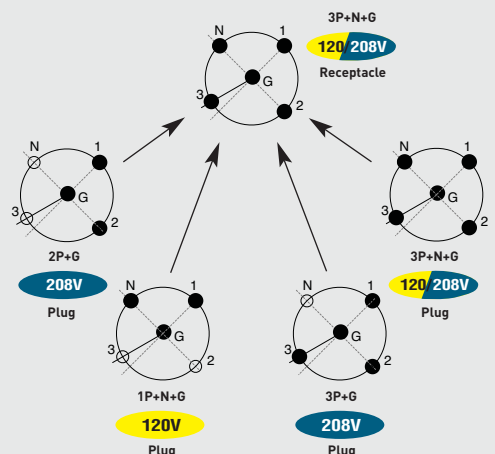

Device Materials and their Resistance to Environments and Chemicals

Polymeric Materials

Casings – The common technical name for the “Poly” material used by Meltric is PBT or PBTP (Polybutylene Teraphthalate). It consists of a special blend of thermoplastic polyester, fiberglass and elastomers which provides outstanding resistance to most chemical agents and environmental conditions, including UV and gamma rays. This material also offers high impact resistance across a broad spectrum of temperatures (shock resistance ratings to IK08).

Interiors – The arc chambers for most Meltric devices are made of Melamine or of a special compound of thermoplastic polyester, fiberglass, and elastomer. Other materials are used such as Polyamide and Bakelite.

Accessories – Handles, angles and wall boxes are made of Polyamide (they are supplied with self tapping screws).

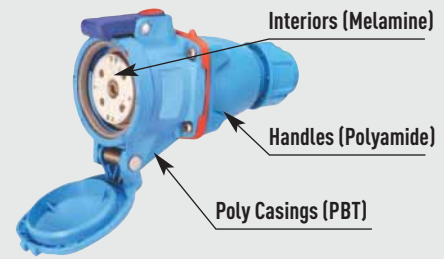

Products with Poly (PBT) casings

DSN20, DSN30, DSN60

DS20, DS30, DS60, DS100, DS100C

DR30, DR50, DR100, DR150

DXN20, DXN30, DXN60

DSN24, DSN37, DS7, DR7

Resistance of Polymeric Casings to Various Chemical Agents

Agent	Polyester reinforced glass fiber			Polyamide		
	23°C	60°C	80°C	23°C	60°C	80°C
Butyl acetate	☆☆	☆☆		☆☆		
Ethyl acetate	☆			☆☆		
Acetone	☆			☆☆		
Acetic acid	5%	☆☆	☆☆	☆	☆	-
	10%	☆☆	☆	☆	-	-
Hydrochloric acid	10%	☆☆	☆☆	☆☆	☆	-
Chromic acid	40%	☆☆	☆☆	☆☆	-	-
Citric acid	10%	☆☆	☆☆	☆☆	☆	
Formic acid	5%	☆☆	☆	☆☆	☆	
Nitric acid	10%	☆☆	☆	☆☆	☆	-
Oleic acid	100%	☆☆	☆☆	☆☆	☆☆	☆☆
Phosphoric acid	3%	☆☆	☆☆	☆☆	☆☆	☆☆
	30%	☆☆	☆☆	☆☆	-	-
	85% (conc)	☆☆	☆☆	☆☆	-	-
Sulphuric acid	3%	☆☆	☆☆	☆☆	-	-
	30%	☆☆	☆☆	☆☆	-	-
Ethyl alcohol		☆☆		☆☆		
Methyl alcohol		☆☆		☆☆		
Aniline		☆☆		-		
Benzene		☆	☆	☆☆		
Soda Bicarbonate	10%	☆☆	☆☆	-	☆☆	☆☆
Potassium bichromate	10%		☆☆		☆☆	☆☆
Sodium bisulphate	10%	☆☆	☆☆	-	☆☆	☆☆
Butane		☆☆		☆☆		
Butanol		☆☆		☆☆		
Soda carbonate	10%	☆☆	-	☆☆	☆☆	☆☆
	20%	☆☆	-	☆☆	☆☆	☆☆
Disulphuric carbonate		☆☆		☆☆		
Calcium chloride	10%	☆☆	☆☆	☆☆		
Potassium chloride	10%	☆☆	☆☆	-	☆☆	
Sodium chloride	10%	☆☆	☆☆	-	☆☆	
Detergents	1%	☆☆	☆☆	-	☆☆	☆☆
	25%	☆☆	☆☆	-	☆☆	☆☆
Dibutylphthalate		☆☆	☆☆	☆☆		
Dichlorethane		-		☆☆		
Dioxane		☆☆	-	☆☆		
Water		☆☆	☆☆	-	☆☆	☆☆
Bleach		☆☆	☆☆	☆☆		
Gas		☆☆		☆☆		
Turpentine		☆☆		☆☆		

Agent	Polyester reinforced glass fiber			Polyamide		
	23°C	60°C	80°C	23°C	60°C	80°C
White spirit	☆☆			☆☆		
Ether	☆☆			☆☆		
Freon 11	☆☆			☆☆		
Glycerine	☆☆	☆☆		☆☆	☆☆	-
Glycol	☆☆	☆☆		☆☆	☆☆	-
Grease	☆☆	☆☆	☆☆	☆☆	☆☆	☆☆
Heptane	☆☆			☆☆		
Hexane	☆☆			☆☆		
Cotton seed oil	☆☆	☆☆	☆☆	☆☆	☆☆	☆☆
Silicon oil	☆☆	☆☆	☆☆	☆☆	☆☆	☆☆
Processing oil	☆☆	☆☆	☆☆	☆☆	☆☆	☆☆
Diesel oil	☆☆			☆☆		
Olive oil	☆☆	☆☆	☆☆	☆☆	☆☆	☆☆
Mineral oil	☆☆	☆☆	☆☆	☆☆	☆☆	☆☆
Engine oil	☆☆	☆☆	☆☆	☆☆	☆☆	☆☆
Plant oil	☆☆	☆☆	☆☆	☆☆	☆☆	☆☆
Ammonium hydroxide	10%	☆☆		☆☆		
	conc	-	-	☆☆		
Potassium hydroxide	1%	-	-	☆☆		
	10%	-	-	☆☆		
Sodium hydroxide	1%	-	-	☆☆		
	10%	-	-	☆☆		
Calcium hypochlorite	☆☆	☆☆		☆☆		
Sodium hypochlorite	10%	☆☆	☆☆	-	-	-
Isopropanol	☆☆	☆☆		☆☆		
Braking liquid	☆☆	☆☆	☆☆	☆☆		
Methylethycetone	☆☆	☆☆		☆☆		
Perchloroethylene	☆☆	☆☆		☆☆	☆☆	-
Potassium permanganate	10%	☆☆		-	-	-
Oil		-		-		
Hydrogen peroxide	3%	☆☆		-		
	30%	☆☆		-		
Soap solution	1%	☆☆	-	☆☆		
Carbon tetrachloride	☆☆			☆☆		
Tetrahydrofurane	☆☆			☆☆		
Toluene	☆☆			☆☆		
Trichlorethylene	☆☆			☆☆	☆☆	☆☆
Vaseline	☆☆	☆☆	☆☆	☆☆	☆☆	☆☆
Xylene	☆☆			☆☆		

Legend: ☆☆☆ = Excellent ☆ = Good - = Poor

Metal Materials

Casings – Metal casings providing even greater impact resistance are standard on some Meltric products and are optional on others. Depending upon the product line, these casings may be made of zamak, aluminum or stainless steel. Zamak, a zinc - aluminum alloy is the most commonly used. Zamak receptacles are blue epoxy coated and zamak plugs are specially treated to further improve corrosion resistance.

Contacts – All Meltric contact surfaces are made of solid silver-nickel with the exception of the PF and PFQ contacts which are solid pure silver. Silver-nickel and silver both provide excellent resistance to climatic conditions and to all known chemical agents found in industry with the exception of sulphuric acid. Products installed in sulphuric acid environments should have an environmental rating of at least NEMA 4X or IP66.

Accessories – Wall boxes, angles, and handles are in zamak or aluminum alloy. All zamak accessories are standardly protected by an epoxy paint.

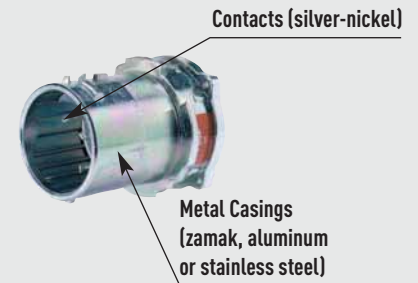

Products with Metal Zamak casings:

DS60, DS100C, DS100, DS200

DB30, DB60, DB100

DR100, DR150, DR250

PN7c, PN12c, DN7c, DN20c, DS7c, DR7c

Products with Aluminum Casings

PN (HT)

DX20, DX30, DX60, DX100

PFQ300, PF300, PF400, PF600

Products with Stainless Steel Casings

PN7c, PN12c

DS24c, DS37c

Contact customer service for availability of Stainless Steel on other products

Resistance of Metal Casings to Corrosive Agents

Agent	Protected Zamak or Aluminum
Dry lightning gas	☆☆
Water steam	☆
Hot water	☆
Artificial sea water	☆
Soluble oil 3%	☆
Soluble oil 5%	☆☆
Cleansing soap	☆☆
Potash solution 1%	☆
Potash solution 5%	☆
Ammonia 1%	☆
Ammonia 5%	☆
Sodium chloride 1%	☆
Sodium chloride 5%	☆
Acetic acid 1%	☆
Acetic acid 5%	-
Gas	☆☆
Engine oil	☆☆
Printing ink	☆
Ethyl or methyl alcohol	☆☆
Trichloethylene	☆
Dry insecticides	☆

Legend: ☆☆ = Excellent ☆ = Good - = Poor

Watertightness / Ingress Protection (NEMA and IP ratings)

Environmental Ratings for Meltric Devices



Most Meltric products achieve rated watertightness as soon as the plug is fully inserted into the receptacle. The primary exception is the DB product line which requires the turning of a locking ring.

Product	Type	IP (plug + receptacle)	IP (receptacle alone)
DSN	4X	66+67	66+67
DS*	3R	54	55
DB	-	67	67
DXN	-	66+67	66+67
DXN25c/37c	-	66+67	66+67
DX	-	65	65
DN	-	54	55
PF/PFQ	-	66+67	66+67
DR*	3R	54	55
PN	-	66+67	66+67
PXN12c	-	65+66	65+66
SP	-	66+67	66+67
SPeX	-	66	66

* Additional watertightness is available on DS and DR devices, see pg 200

Environmental Ratings Explained:

NEMA/UL/CSA Enclosure Types (UL50)

NEMA Enclosure Type	Intended Use and Description
1	Indoor use primarily to provide a degree of protection against limited amounts of falling dirt
2	Indoor use primarily to provide a degree of protection against limited amounts of waste and falling dirt
3, 3R, 3S	Outdoor use primarily to provide a degree of protection against rain, sleet, and damage from external ice formation.
4, 4X	Indoor or outdoor use primarily to provide a degree of protection against windblown dust and rain, splashing water, hose-directed water, and damage from external ice formation
12	Indoor use primarily to provide a degree of protection against circulating dust, falling dirt and dripping non-corrosive liquids

IP Ratings (IEC/EN 60529)

First Digit		Second Digit	
Protection against the ingress of solid foreign objects and access to hazardous parts		Protection against the ingress of water with harmful effects	
0	No protection	0	No protection
1	50mm Back of hand	1	Vertically dripping water (condensation)
2	12.5mm Finger	2	Dripping water at 15°
3	2.5mm Tool	3	Spraying water at 60° (rain)
4	1mm Wire	4	Splashing water from any direction
5	Against Dust -	5	Jetting water from any direction
6	Dust-tight -	6	Powerful jetting water from any direction
-		7	Temporary submersion

Impact Resistance

Meltric product resistance to mechanical shocks is specified in accordance with their IK ratings.

Meltric Products IK Ratings (per IEC/EN 50102)

Product	Material	IK Rating
DSN	Poly	08 (5 Joules)
DS	Poly	08 (5 Joules)
DS	Metal	09 (10 Joules)
DB	Metal	09 (10 Joules)
DR	Poly	08 (5 Joules)
DR	Metal	09 (10 Joules)
DN	Metal	09 (10 Joules)
PN	Poly	08 (5 Joules)
PN/PXN12c	Metal	09 (10 Joules)
PF	Metal	10 (20 Joules)
DX	Metal	10 (20 Joules)
DXN	Poly	08 (5 Joules)
DXN25c/37c	Metal	09 (10 Joules)
SP/SPeX	Poly	08 (5 Joules)



Operating Temperatures

All Meltric plugs and receptacles (except SPeX) can be used with no particular precaution from -15°F to 140°F/-26°C to 60°C.

Hot Temperatures

Some devices that do not contain any polyamide can operate up to 175°F/80°C but precise conditions and duty cycles must be submitted to the Meltric engineering department for approval. A limited range of products are available for ambient temperatures up to 365°F/185°C. Contact Meltric customer service for more information.

Cold Temperatures

Below -15°F materials become more brittle and impact should be avoided, especially on polyamide materials. However, Meltric's metal and polyester casings can be used as low as -40°F/-40°C and some Meltric devices are in service at -75°F/-60°C. Consult factory for more information.

Note: SPeX temperature range Min -4°F/Max 140°F

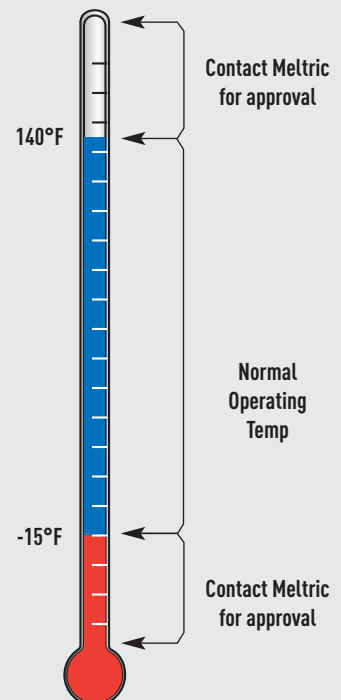

Color Coded Gaskets & Labels

For Voltage Identification

PIN CONFIGURATION	VOLTAGE RANGE	FREQUENCY	5th, 6th and 7th PART NUMBER DIGITS	RECEPTACLE/CONNECTOR		PLUG/INLET	
				COLOR GASKET	VOLTAGE STICKER	COLOR GASKET	VOLTAGE STICKER
1P+N+G	110 - 125V	60Hz	075	ORANGE	ORANGE	ORANGE	ORANGE
	120 - 127V	60Hz	165	YELLOW	YELLOW	YELLOW	YELLOW
	255 - 277V	60Hz	045	GREY	GREY	GREY	GREY
	347V	60Hz	145	RED	RED	RED	RED
	110 - 130V	50Hz	035	YELLOW	YELLOW	YELLOW	YELLOW
	220 - 250V	50Hz	015	BLUE	BLUE	BLUE	BLUE
	380 - 440V	50Hz	195	RED	RED	RED	RED
	577V	50Hz	225	BLACK	BLACK	BLACK	BLACK
	115 - 127V	200Hz	125	GREEN	YELLOW	GREEN	YELLOW
	115 - 127V	400Hz	115	GREEN	YELLOW	GREEN	YELLOW
2P	20 - 24V	60Hz	02A	VIOLET	VIOLET	VIOLET	VIOLET
	20 - 24V	50Hz	08A	VIOLET	VIOLET	VIOLET	VIOLET
	25 - 28V	50Hz	06A	VIOLET	VIOLET	VIOLET	VIOLET
	40 - 48V	50Hz	13A	WHITE	WHITE	WHITE	WHITE
2P+G	208 - 220V	60Hz	162	BLUE	BLUE	BLUE	BLUE
	220 - 250V	60Hz	072	ORANGE	ORANGE	ORANGE	ORANGE
	440 - 480V	60Hz	042	RED	RED	RED	RED
	600V	60Hz	142	BLACK	BLACK	BLACK	BLACK
	190 - 230V	50Hz	032	BLUE	BLUE	BLUE	BLUE
	380 - 440V	50Hz	012	RED	RED	RED	RED
	480 - 500V	50Hz	092	BLACK	BLACK	BLACK	BLACK
	660 - 690V	50Hz	192	BLACK	BLACK	BLACK	BLACK
	1000V	50Hz	222	BLACK	BLACK	BLACK	BLACK
	200 - 220V	200Hz	122	GREEN	BLUE	GREEN	BLUE
	200 - 220V	400Hz	112	GREEN	BLUE	GREEN	BLUE
	110 - 130V	DC	109	YELLOW	YELLOW	YELLOW	YELLOW
	220 - 250V	DC	209	BLUE	BLUE	BLUE	BLUE

PIN CONFIGURATION	VOLTAGE RANGE	FREQUENCY	5th, 6th and 7th PART NUMBER DIGITS	RECEPTACLE/CONNECTOR		PLUG/INLET	
				COLOR GASKET	VOLTAGE STICKER	COLOR GASKET	VOLTAGE STICKER
2P+N+G	110 - 125V 220 - 250V	60Hz	076	ORANGE	ORANGE	ORANGE	ORANGE
	120 - 127V 208 - 220V	60Hz	166	BLUE	YELLOW BLUE	BLUE	YELLOW BLUE
	255 - 277V 440 - 480V	60Hz	046	RED	GREY RED	RED	GREY RED
	347 - 600V	60Hz	146	BLACK	RED BLACK	BLACK	RED BLACK
	110 - 130V 190 - 230V	50Hz	036	BLUE	YELLOW BLUE	BLUE	BLUE
	220 - 250V 380 - 440V	50Hz	016	RED	BLUE RED	RED	RED
	380 - 400V 660 - 690V	50Hz	196	BLACK	RED BLACK	BLACK	BLACK
	480 - 500V	50Hz	096	BLACK	BLACK	BLACK	BLACK
	115 - 127V 200 - 220V	200Hz	126	GREEN	YELLOW BLUE	GREEN	BLUE
	115 - 127V 200 - 220V	400Hz	116	GREEN	YELLOW BLUE	GREEN	BLUE
3P+G	208 - 220V	60Hz	163	BLUE	BLUE	BLUE	BLUE
	220 - 250V	60Hz	073	ORANGE	ORANGE	ORANGE	ORANGE
	440 - 480V	60Hz	043	RED	RED	RED	RED
	600V	60Hz	143	BLACK	BLACK	BLACK	BLACK
	190 - 230V	50Hz	033	BLUE	BLUE	BLUE	BLUE
	380 - 440V	50Hz	013	RED	RED	RED	RED
	480 - 500V	50Hz	093	BLACK	BLACK	BLACK	BLACK
	660 - 690V	50Hz	193	BLACK	BLACK	BLACK	BLACK
	1000V	50Hz	223	BLACK	BLACK	BLACK	BLACK
	200 - 220V	200Hz	123	GREEN	BLUE	GREEN	BLUE
200 - 220V	400Hz	113	GREEN	BLUE	GREEN	BLUE	
3P+N+G	110 - 125V 220 - 250V	60Hz	077	ORANGE	ORANGE	ORANGE	ORANGE
	120 - 127V 208 - 220V	60Hz	167	BLUE	YELLOW BLUE	BLUE	YELLOW BLUE
	255 - 277V 440 - 480V	60Hz	047	RED	GREY RED	RED	GREY RED
	347 - 600V	60Hz	147	BLACK	RED BLACK	BLACK	RED BLACK
	110 - 130V 190 - 230V	50Hz	037	BLUE	YELLOW BLUE	BLUE	BLUE
	220 - 250V 380 - 440V	50Hz	017	RED	BLUE RED	RED	RED
	380 - 400V 660 - 690V	50Hz	197	BLACK	RED BLACK	BLACK	BLACK
	480 - 500V	50Hz	097	BLACK	BLACK	BLACK	BLACK
	115 - 127V 200 - 220V	200Hz	127	GREEN	YELLOW BLUE	GREEN	BLUE
	115 - 127V 200 - 220V	400Hz	117	GREEN	YELLOW BLUE	GREEN	BLUE
MULTIPIN		NOT SPECIFIED		SKY BLUE	SKY BLUE	SKY BLUE	SKY BLUE

Index

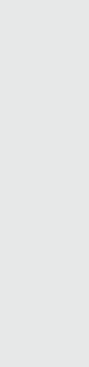
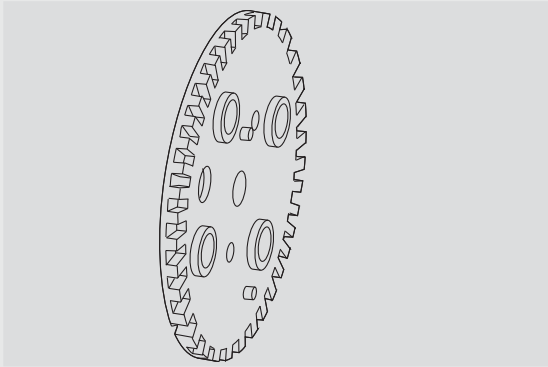
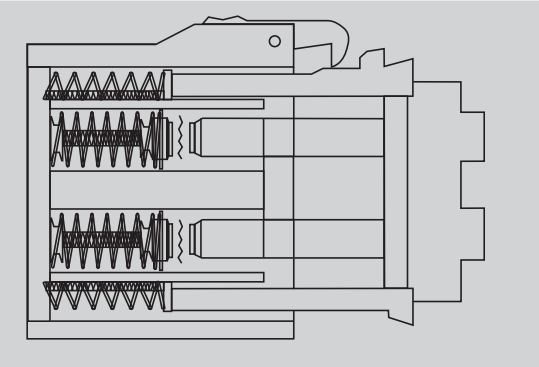
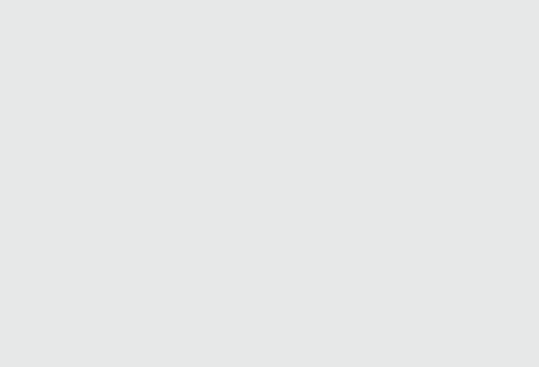
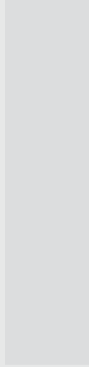
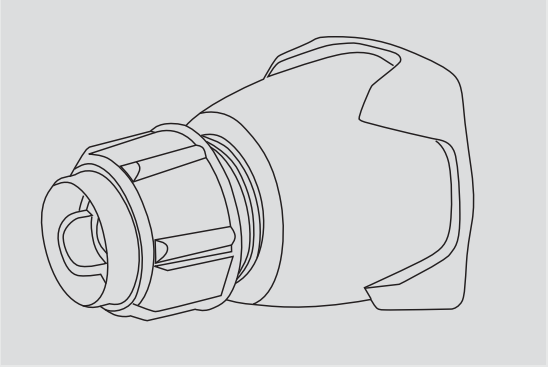
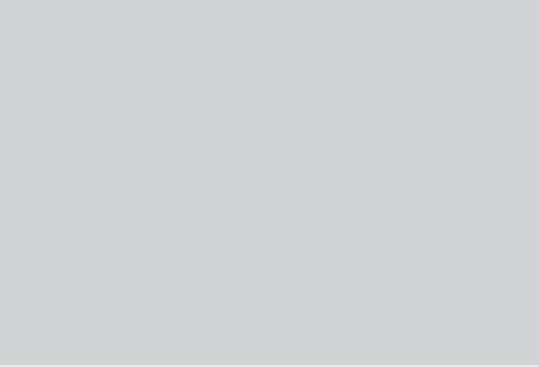

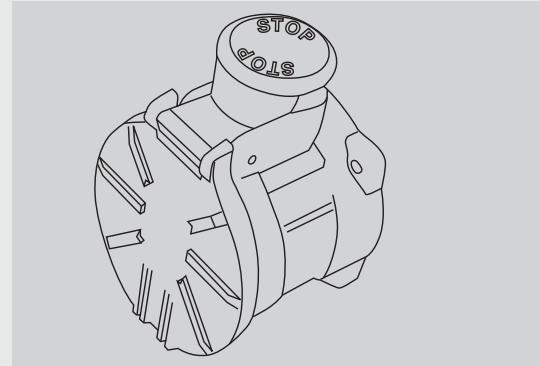
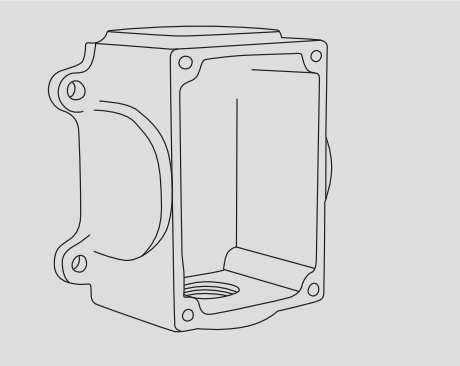

INDEX

Suffix Index	p. 225
Part Number Index	p. 227
Literature Order Form	p. 238

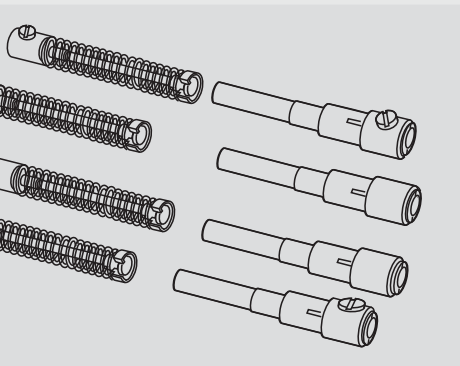
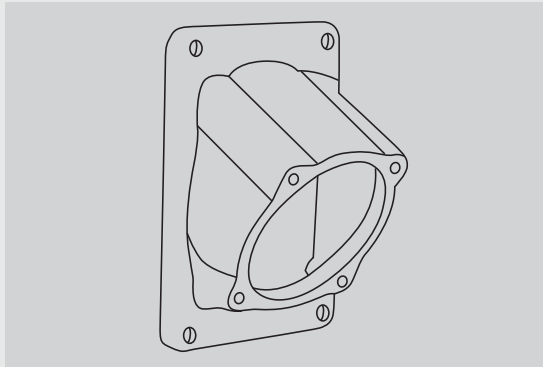

Suffixes

Quick Reference Table

Suffix	Description	Applicable Products	Special Instructions
-001	Reverse interior for PN, DSN24, DSN37 device only	PN, DSN24, DSN37	Add to inlet and receptacle part numbers
-026	Black device gasket	DS, DR, DSN	
-080	Junction box with angle	All	
-1	1" NPT thread size for conduit entry	DSN, DS, DR, DX, PN, DN, DB	Add to applicable accessories
-112	1 1/2" NPT thread size for conduit entry	DSN, DS, DR, DX, DN, DB	Add to applicable accessories
-12	1/2" NPT thread size for conduit entry	DS, DR, DX, DN, DB	Add to applicable accessories
-114	1 1/4" NPT thread size for conduit entry	DSN, DS, DR, DX, PN, DN, DXN, DB	Add to applicable accessories
-172	Two auxiliary pilot contacts	DS200, DS100, DB30, DB60	Add to inlet and receptacle part number
-173	Three auxiliary pilot contacts	DS200, DS100	Add to inlet and receptacle part number
-174	Four auxiliary pilot contacts	DS200, DS100, DB100	Add to inlet and receptacle part number
-175	Five auxiliary pilot contacts	DS200, DS100	Add to inlet and receptacle part number
-180	180° lid opening for flush mounted inlets	DS100, DS200, DR150, DR250	Add to the receptacle part number
-185	High temp product	PN	Add to inlet or receptacle part number
-2	2" NPT thread size for conduit entry	DS, DR, DX, DN, DB	Add to applicable accessories
-200	Cable range for PF/PFQ Handle 2.000" - 2.125"	PF/PFQ	Add to the handle part number
-20	2" NPT fitting size	PF/PFQ	Add to PF/PFQ junction box
-20P	Cable range .28" - .41"	DXN20, DXN30	Add to plug/connector part number
-212	2 1/2" NPT thread size for conduit entry	DS, DR, DN	
-225	Cable range for PF/PFQ Handle 2.125" - 2.375"	PF/PFQ	Add to the handle part number
-237	Cable range for PF/PFQ Handle 2.25" - 2.375"	PF/PFQ	Add to the handle part number
-25	2 1/2" NPT fitting size	PF/PFQ	Add to PF/PFQ junction box
-25P	Cable range .35" - .67"	DXN	Add to plug/connector part number
-250	Cable range for PF/PFQ Handle 2.375" - 2.5"	PF/PFQ	Add to the handle part number
-263	Three auxiliary pilot contacts	DS60, DS100C, DR100	Add to inlet and receptacle part number
-270	Auxiliary switch for female devices	DS, DSN, DR	Add to receptacle part number
-275	Cable range for PF/PFQ Handle 2.5" - 2.75"	PF/PFQ	Add to the handle part number
-30	3" NPT fitting size	PF/PFQ	Add to PF/PFQ junction box
-300	Cable range for PF/PFQ Handle 2.75" - 3"	PF/PFQ	Add to the handle part number
-30A	30A capacity for PN devices	PN	Add to inlet & receptacle part numbers
-312	Cable range for PF/PFQ Handle 3" - 3.125"	PF/PFQ	Add to the handle part number
-32P	Cable range .43" - .83"	DXN	Add to plug/connector part number
-335	Cable range for PF/PFQ Handle 3.125" - 3.35"	PF/PFQ	Add to the handle part number
-338	PRL release pawl	DS, DSN, DR	Add to inlet part number
-338-A188	PRL release pawl with straight insertion for inlets	DS, DN, DSN, DR	Add to inlet part number
-34	3/4" NPT thread size for conduit entry	DSN, DS, DR, DX, PN, DN, DXN, DB	Add to applicable accessories
-345-A188	SRL release pawl with straight insertion for receptacles	DSN	Add to receptacle part number
-348-A188	SRL release pawl with straight insertion for receptacles	DS, DN, DR	Add to receptacle part number

Suffix	Description	Applicable Products	Special Instructions
-35	3 1/2" NPT fitting size	PF/PFQ	Add to PF/PFQ junction box
-350	Cable range for PF/PFQ Handle 3.35" - 3.5"	PF/PFQ	Add to the handle part number
-375	Mushroom Pawl	DS, DSN, DR	Add to receptacle part number
-375-843	Padlockable Mushroom Pawl	DS, DSN, DR, DN	Add to receptacle part number
-3NF	Non functioning contact to activate auxiliary switch	DS, DSN	Activates 2 Pole 4 wire receptacle.
-40	4 NPT fitting size	PF/PFQ	Add to PF/PFQ junction box
-40P	Cable range .75" - 1.10"	DXN	Add to plug/connector part number
-473	Finger drawplate on handle	DS	Add to handle part number
-48	Inlet or receptacle without cap	PF, DB	Add to inlet and receptacle part number
-4X	Type 4X watertightness	DS, DR	Add to inlet and receptacle
-601	Special adapter plate for DSN1 angle on junction box	DSN20	
-824	Metal pawl for poly receptacles	DS, DSN, DR	
-824-300	Locking pawls	PN	Add to the receptacle part number
-843	Padlock pawl	DS, DSN, DR	Add to receptacle part number
-845	Oversize padlock pawl	DS, DR	Add to receptacle part number
-924	Metal Pawl for Poly Receptacles	DXN	Add to Receptacle part number
-972	Two auxiliary pilot contacts	DS20-60, DSN30-60, DR30-100	Add to inlet and receptacle part number
-973	Three auxiliary pilot contacts	DSN60, DS30-60, DR50	Add to inlet and receptacle part number
-974	Four auxiliary pilot contacts	DS30, DS60, DSN60	Add to inlet and receptacle part number
-A06	Allows up to 4/0 AWG wiring capacity	DS200, DR250	Add to inlet and receptacle part number
-A155	Inlet without the standard lockout hole	DS, DSN	Add to inlet part number
-A188	Straight insertion	DS, DSN, DN, DR	Add to inlet and receptacle part number
-B	Bottom interior piece	All	
-CG	Cable guide for PRL or SRL release pawl for handle	DS, DSN, DN	Add to handle part number
-C-***	Suffixes for DS100C inlets & receptacles	DS	Included in inlet/receptacle part number
-E323	Allows up to 2/0 AWG wiring capacity	DS100, DR150	
-HP	High pressure water protection	DN	Add to inlet and receptacle part number
-K**	Voltage being used when notching position is not standard	All	Add to inlet and receptacle part number
-LC	Less cover	DS, DSN	Add to receptacle part number
-MTR	Phase Rotation Meter	DS, DSN, DR, DB	Add to Plug
-NC	Normally closed lid	DS, DSN, DR, DN	Add to receptacle part number
-NNF	Non Functioning Neutral - Activates 3 Pole 4 wire receptacle	DS, DSN, DR	Add to inlet part number
-NP	No paint on accessories	All accessories	
-R	Normally closed lid	DXN	Add to receptacle part number
-SS	Stainless steel	PN7, PN12, DS	
-T	Top interior piece	All	

Parts Index

Part Number	Pages	Part Number	Pages	Part Number	Pages	Part Number	Pages	Part Number	Pages
01-2A010	163	01-NA013-12	100*	09-08041-SS	111	09-AA910	123	09-P4051	111
01-2A010-185	163	01-NA013-34	100*	09-08051-SS	111	09-AA920	124	09-P4061	111
01-2A010-185-B	163	01-NA014	123*	09-08061-SS	111	09-M4051	99	09-P8041	111
01-2A010-185-T	163	01-NA023-12	100*	09-24012-185	161	09-M4061	99	09-P8051	111
01-2A010-B	163	01-NA023-34	100*	09-24013-185	161	09-M4071	99	09-P8061	111
01-2A010-T	163	01-NA024	123	09-24015-185	161	09-M4081	99	09-PA910	123
01-2A011	163	01-NA025-12	100*	09-24016-185	161	09-M4091	99	09-PA911	123
01-2A011-185	163	01-NA025-34	100*	09-24017-185	161	09-M4101	99	09-PA919	123
01-2A020	164	01-NA027	100*	09-24032-185	161	09-M4111	99	09-PA920	124
01-2A020-185	164	01-NA053-080-12	100*	09-24033-185	161	09-M8051	99	09-PA921	124
01-2A020-185-B	164	01-NA126	100*	09-24035-185	161	09-M8061	99	09-PA929	124
01-2A020-185-T	164	01-NA313	100*	09-24037-185	161	09-M8071	99	09-S4042	159
01-2A020-B	164	01-NA583	163*	09-28012-185	161	09-M8081	99	09-S4043	159
01-2A020-T	164	01-P4041	111	09-28013-185	161	09-M8091	99	09-S4045	159
01-2A021	164	01-P4051	111	09-28015-185	161	09-M8101	99	09-S4047	159
01-2A021-185	164	01-P4061	111	09-28016-185	161	09-M8111	99	09-S4072	159
01-2A142	100*	01-P8041	111	09-28017-185	161	09-N4042	159	09-S4073	159
01-AA113	123	01-P8051	111	09-28032-185	161	09-N4043	159	09-S4075	159
01-AA910	123	01-P8061	111	09-28033-185	161	09-N4045	159	09-S4076	159
01-AA920	124	01-S4042	159	09-28035-185	161	09-N4047	159	09-S4142	159
01-MA911	123	01-S4043	159	09-28037-185	161	09-N4072	159	09-S4143	159
01-MA921	124	01-S4045	159	09-2A013-SS-12	102	09-N4073	159	09-S4147	159
01-N4042	159	01-S4047	159	09-2A013-SS-34	112*	09-N4075	159	09-S4162	159
01-N4043	159	01-S4072	159	09-2A014-185	163	09-N4076	159	09-S4163	159
01-N4045	159	01-S4073	159	09-2A024-185	164	09-N4142	159	09-S4167	159
01-N4047	159	01-S4075	159	09-2A025-185-12	161	09-N4143	159	09-SA024	164
01-N4072	159	01-S4076	159	09-2A025-185-34	161	09-N4147	159	17-14051	113
01-N4073	159	01-S4142	159	09-2A027	112	09-N4162	159	17-14060	113
01-N4075	159	01-S4143	159	09-2A027-185	162	09-N4163	159	17-14061	113
01-N4076	159	01-S4147	159	09-2A027-SS	102*	09-N4167	159	17-14070	113
01-N4142	159	01-S4162	159	09-2A053-080-SS-1	102*	09-N8042	159	17-14071	113
01-N4143	159	01-S4163	159	09-2A583	163*	09-N8043	159	17-14080	113
01-N4151	159	01-S4167	159	09-2A583-185	163*	09-N8045	159	17-14081	113
01-N4162	159	03-A4001	99	09-2A913-67	162	09-N8047	159	17-14090	113
01-N4163	159	03-A8001	99	09-34012-185	161	09-N8072	159	17-18051	113
01-N4167	159	04-2A090-5-10	100*	09-34013-185	161	09-N8073	159	17-18060	113
01-N8042	159	04-2A090-5-12	100*	09-34015-185	161	09-N8075	159	17-18061	113
01-N8043	159	04-2A090-5-34	100*	09-34016-185	161	09-N8076	159	17-18070	113
01-N8045	159	06-M0111-XXX	94	09-34017-185	161	09-N8142	159	17-18071	113
01-N8047	159	06-M1111	94	09-34032-185	161	09-N8143	159	17-18080	113
01-N8072	159	06-M1111-XXX	94	09-34033-185	161	09-N8147	159	17-18081	113
01-N8073	159	06-M3111-XXX	94	09-34035-185	161	09-N8162	159	17-18090	113
01-N8075	159	06-M6111-XXX	94	09-34037-185	161	09-N8163	159	19-1A014	123
01-N8076	159	06-M7111-XXX	94	09-38012-185	161	09-N8167	159	19-1A024	124
01-N8142	159	06-M9111	94	09-38013-185	161	09-NA014	123*	19-1A711	123
01-N8143	159	07-A4001	99	09-38015-185	161	09-NA024	124*	19-1A721	124
01-N8147	159	07-A8001	99	09-38016-185	161	09-NA025-12	100*	19-1A910	123
01-N8162	159	07-A4001-SS	101	09-38017-185	161	09-NA025-34	100*	19-1A911	123
01-N8163	159	07-A8001-SS	101	09-38032-185	161	09-NA027	100*	19-1A920	124
01-N8167	159	09-04041-SS	111	09-38033-185	161	09-NA053-080-12	100*	19-1A921	124
01-NA013	100*	09-04051-SS	111	09-38035-185	161	09-NA053-080-12-185	162	19-1A925	124
01-NA013-1	100*	09-04061-SS	111	09-38037-185	161	09-P4041	111	19-34061	117

Part Number	Pages	Part Number	Pages	Part Number	Pages	Part Number	Pages	Part Number	Pages
19-38061	117	17-68191	115	22-18047	73	22-3A013-20P	76	26-20073-XX	85
19-3A010-777	123	17-68200	115	22-18072	73	22-3A013-25P	76	26-20075-XX	85
19-3A011-777	123	19-6A010-777	123	22-18073	73	22-3A013-32P	76	26-20076-XX	85
19-3A014	123	19-6A011-777	123	22-18075	73	22-3A013-40P	76	26-20142-XX	85
19-3A019-777	123	19-6A013-1	118	22-18076	73	22-3A023-34-B	76	26-20143-XX	85
19-3A020-777	124	19-6A013-112	118	22-18162	73	22-3A023-34-T	76	26-20147-XX	85
19-3A021-777	124	19-6A013-114	118	22-18163	73	22-3A027	76	26-20162-XX	85
19-3A024	124	19-6A013-2	118	22-18167	73	22-3A126	76	26-20163-XX	85
19-3A029-777	124	19-6A013-34	118	22-1A013-12	74	22-3AB58	76	26-20167-XX	85
19-64061	117	19-6A014	123	22-1A013-34	74	22-64042	77	26-21042-XXXX	85
17-64091	115	19-6A019-777	123	22-1A013-20P	74	22-64043	77	26-21043-XXXX	85
17-64100	115	19-6A020-777	124	22-1A013-25P	74	22-64045	77	26-21045-XXXX	85
17-64101	115	19-6A021-777	124	22-1A013-32P	74	22-64047	77	26-21047-XXXX	85
17-64110	115	19-6A024	124	22-1A023-12	74	22-64072	77	26-21072-XXXX	85
17-64111	115	19-6A029-777	124	22-1A023-12-B	74	22-64073	77	26-21073-XXXX	85
17-64120	115	19-6A711	123	22-1A023-12-T	74	22-64075	77	26-21075-XXXX	85
17-64121	115	19-6A721	124	22-1A023-34-B	74	22-64076	77	26-21076-XXXX	85
17-64130	115	19-6A910	123	22-1A023-34-T	74	22-64142	77	26-21142-XXXX	85
17-64131	115	19-6A911	123	22-1A027	74	22-64143	77	26-21143-XXXX	85
17-64140	115	19-6A920	124	22-1A126	74	22-64147	77	26-21147-XXXX	85
17-64141	115	19-6A921	124	22-1AB58	74	22-64162	77	26-21162-XXXX	85
17-64150	115	19-6A925	124	22-34042	75	22-64163	77	26-21163-XXXX	85
17-64151	115	19-9A010-777	123	22-34043	75	22-64167	77	26-21167-XXXX	85
17-64160	115	19-9A011-777	123	22-34045	75	22-68042	77	26-23042-XXXX	85
17-64161	115	19-9A019-777	123	22-34047	75	22-68043	77	26-23043-XXXX	85
17-64170	115	19-9A020-777	124	22-34072	75	22-68045	77	26-23045-XXXX	85
17-64171	115	19-9A021-777	124	22-34073	75	22-68047	77	26-23047-XXXX	85
17-64180	115	19-9A029-777	124	22-34075	75	22-68072	77	26-23072-XXXX	85
17-64181	115	1H1SS	106	22-34076	75	22-68073	77	26-23073-XXXX	85
17-64190	115	1PH1	38*	22-34142	75	22-68075	77	26-23075-XXXX	85
17-64191	115	1PH114	38*	22-34143	75	22-68076	77	26-23076-XXXX	85
17-64200	115	1PH12	38*	22-34147	75	22-68142	77	26-24072	85
19-68061	117	1PH34	38*	22-34162	75	22-68143	77	26-24073	85
17-68091	115	1PM514	28*	22-34163	75	22-68147	77	26-24075	85
17-68100	115	1PM516	28*	22-34167	75	22-68162	77	26-24076	85
17-68101	115	1PM518	28*	22-38042	75	22-68163	77	26-24142	85
17-68110	115	1PM520	28*	22-38043	75	22-68167	77	26-24143	85
17-68111	115	1PM522	28*	22-38045	75	22-6A013-25P	78	26-24147	85
17-68120	115	22-14042	73	22-38047	75	22-6A013-32P	78	26-24162	85
17-68121	115	22-14043	73	22-38072	75	22-6A013-40P	78	26-24163	85
17-68130	115	22-14045	73	22-38073	75	22-6A013-1	78	26-24167	85
17-68131	115	22-14047	73	22-38075	75	22-6A023-1-B	78	26-26042-XX	85
17-68140	115	22-14072	73	22-38076	75	22-6A023-1-T	78	26-26043-XX	85
17-68141	115	22-14073	73	22-38142	75	22-6A027	78	26-26045-XX	85
17-68150	115	22-14075	73	22-38143	75	22-6A126	78	26-26047-XX	85
17-68151	115	22-14076	73	22-38147	75	22-6AB58	78	26-26072-XX	85
17-68160	115	22-14162	73	22-38162	75	22-9A126	88	26-26073-XX	85
17-68161	115	22-14163	73	22-38162	75	26-20042-XX	85	26-26075-XX	85
17-68170	115	22-14167	73	22-38163	75	26-20043-XX	85	26-26076-XX	85
17-68171	115	22-18042	73	22-38167	75	26-20045-XX	85	26-26142-XX	85
17-68181	115	22-18043	73	22-3A013-1	76	26-20047-XX	85	26-26143-XX	85
17-68190	115	22-18045	73	22-3A013-34	76	26-20072-XX	85	26-26147-XX	85

Note: * This part number is also displayed on other pages.

Parts Index

Part Number	Pages	Part Number	Pages	Part Number	Pages	Part Number	Pages	Part Number	Pages
26-23142-XXXX	85	26-31042-XXXX	86	26-36147-XX	86	26-64045	87	26-93076-XXXX	88
26-23143-XXXX	85	26-31043-XXXX	86	26-36162-XX	86	26-64047	87	26-93142-XXXX	88
26-23147-XXXX	85	26-31045-XXXX	86	26-36163-XX	86	26-64072	87	26-93143-XXXX	88
26-23162-XXXX	85	26-31047-XXXX	86	26-36167-XX	86	26-64073	87	26-93147-XXXX	88
26-23163-XXXX	85	26-31072-XXXX	86	26-3A023-1	86	26-64075	87	26-93162-XXXX	88
26-23167-XXXX	85	26-31073-XXXX	86	26-3A023-12	86	26-64076	87	26-93163-XXXX	88
26-24042	85	26-31075-XXXX	86	26-3A023-34	86	26-64142	87	26-93167-XXXX	88
26-24043	85	26-31076-XXXX	86	26-3A126	86	26-64143	87	26-94042	88
26-24045	85	26-31142-XXXX	86	26-60042-XX	87	26-64147	87	26-94043	88
26-24047	85	26-31143-XXXX	86	26-60043-XX	87	26-64162	87	26-94045	88
26-24072	85	26-31147-XXXX	86	26-60045-XX	87	26-64163	87	26-94047	88
26-24073	85	26-31162-XXXX	86	26-60047-XX	87	26-64167	87	26-94072	88
26-24075	85	26-31163-XXXX	86	26-60072-XX	87	26-66042-XX	87	26-94073	88
26-24076	85	26-31167-XXXX	86	26-60073-XX	87	26-66043-XX	87	26-94075	88
26-24142	85	26-33042-XXXX	86	26-60075-XX	87	26-66045-XX	87	26-94076	88
26-24143	85	26-33043-XXXX	86	26-60076-XX	87	26-66047-XX	87	26-94142	88
26-24147	85	26-33045-XXXX	86	26-60142-XX	87	26-66072-XX	87	26-94143	88
26-24162	85	26-33047-XXXX	86	26-60143-XX	87	26-66073-XX	87	26-94147	88
26-24163	85	26-33072-XXXX	86	26-60147-XX	87	26-66075-XX	87	26-94162	88
26-24167	85	26-33073-XXXX	86	26-60162-XX	87	26-66076-XX	87	26-94163	88
26-26042-XX	85	26-33075-XXXX	86	26-60163-XX	87	26-66142-XX	87	26-94167	88
26-26043-XX	85	26-33076-XXXX	86	26-60167-XX	87	26-66143-XX	87	26-9A023-1	88
26-26045-XX	85	26-33142-XXXX	86	26-61042-XXXX	87	26-66147-XX	87	26-9A023-112	88
26-26047-XX	85	26-33143-XXXX	86	26-61043-XXXX	87	26-66162-XX	87	26-9A023-114	88
26-26072-XX	85	26-33147-XXXX	86	26-61045-XXXX	87	26-66163-XX	87	26-9A023-2	88
26-26073-XX	85	26-33162-XXXX	86	26-61047-XXXX	87	26-66167-XX	87	26-9A126	88
26-26075-XX	85	26-33163-XXXX	86	26-61072-XXXX	87	26-6A023-1	87	2H1	48*
26-26076-XX	85	26-33167-XXXX	86	26-61073-XXXX	87	26-6A023-112	87	2H112	48*
26-26142-XX	85	26-34042	86	26-61075-XXXX	87	26-6A023-114	87	2H114	48*
26-26143-XX	85	26-34043	86	26-61076-XXXX	87	26-6A023-2	87	2H2	48*
26-26147-XX	85	26-34045	86	26-61142-XXXX	87	26-6A126	87	2H212	48*
26-26162-XX	85	26-34047	86	26-61143-XXXX	87	26-90042-XX	88	2PH112	48*
26-26163-XX	85	26-34072	86	26-61147-XXXX	87	26-90043-XX	88	2PH2	48*
26-26167-XX	85	26-34073	86	26-61162-XXXX	87	26-90045-XX	88	2PH212	48*
26-2A023-1	85	26-34075	86	26-61163-XXXX	87	26-90047-XX	88	31-111	38*
26-2A023-12	85	26-34076	86	26-61167-XXXX	87	26-90072-XX	88	31-14172-K07	143
26-2A023-34	85	26-34142	86	26-63042-XXXX	87	26-90073-XX	88	31-14173-K07	143
26-2A126	85	26-34143	86	26-63043-XXXX	87	26-90075-XX	88	31-14175-K07	143
26-30042-XX	86	26-34147	86	26-63045-XXXX	87	26-90076-XX	88	31-14176-K07	143
26-30043-XX	86	26-34162	86	26-63047-XXXX	87	26-90142-XX	88	31-14182-K14	143
26-30045-XX	86	26-34163	86	26-63072-XXXX	87	26-90143-XX	88	31-14183-K14	143
26-30047-XX	86	26-34167	86	26-63073-XXXX	87	26-90147-XX	88	31-14187-K14	143
26-30072-XX	86	26-36042-XX	86	26-63075-XXXX	87	26-90162-XX	88	31-14232-K16	143
26-30073-XX	86	26-36043-XX	86	26-63076-XXXX	87	26-90163-XX	88	31-14233-K16	143
26-30075-XX	86	26-36045-XX	86	26-63142-XXXX	87	26-90167-XX	88	31-14237-K16	143
26-30076-XX	86	26-36047-XX	86	26-63143-XXXX	87	26-93042-XXXX	88	31-14242-K04	143
26-30142-XX	86	26-36072-XX	86	26-63147-XXXX	87	26-93043-XXXX	88	31-14243-K04	143
26-30143-XX	86	26-36073-XX	86	26-63162-XXXX	87	26-93045-XXXX	88	31-14245-K04	143
26-30147-XX	86	26-36075-XX	86	26-63163-XXXX	87	26-93047-XXXX	88	31-14247-K04	143
26-30162-XX	86	26-36076-XX	86	26-63167-XXXX	87	26-93072-XXXX	88	31-18172-K07	143
26-30163-XX	86	26-36142-XX	86	26-64042	87	26-93073-XXXX	88	31-18173-K07	143
26-30167-XX	86	26-36143-XX	86	26-64043	87	26-93075-XXXX	88	31-18175-K07	143

Part Number	Pages	Part Number	Pages	Part Number	Pages	Part Number	Pages	Part Number	Pages
31-18176-K07	143	31-34941	121	31-3A921-172	124	31-6A021-C	50	31-9A024	50*
31-18182-K14	143	31-34950	121	31-3A929	124	31-6A024	50*	31-9A026	123*
31-18183-K14	143	31-34951	121	31-3AB26	49*	31-6A026	123*	31-9A053-080-112	46
31-18187-K14	143	31-34960	121	31-3AC26	49*	31-6A053-080-1	42*	31-9A053-080-114	46
31-18232-K16	143	31-34961	121	31-3AF26	49*	31-6A053-080-112	42*	31-9A053-080-2	46*
31-18233-K16	143	31-34970	121	31-3AM26	123	31-6A053-080-114	42*	31-9A053-080-212	46
31-18237-K16	143	31-38172-K07	145	31-3AN26	49*	31-6A053-080-2	42*	31-9A126	46*
31-18242-K04	143	31-38173-K07	145	31-3AR26	49*	31-6A110-C	49	31-9A583	49*
31-18243-K04	143	31-38175-K07	145	31-611	42*	31-6A126	42*	31-9AB26	49*
31-18245-K04	143	31-38176-K07	145	31-64172-K07	147	31-6A226	42*	31-9AC26	49*
31-18247-K04	143	31-38182-K14	145	31-64173-K07	147	31-6A583	49*	31-9AF26	49*
31-1A010	49*	31-38183-K14	145	31-64175-K07	147	31-6AB26	49*	31-9AN26	49*
31-1A010-B	49*	31-38187-K14	145	31-64176-K07	147	31-6AC26	49*	31-9AR26	49*
31-1A010-T	49*	31-38232-K16	145	31-64182-K14	147	31-6AF26	49*	31-CA213	124
31-1A011	49*	31-38233-K16	145	31-64183-K14	147	31-6AM26	123*	33-14042	37
31-1A014	49*	31-38237-K16	145	31-64187-K14	147	31-6AN26	49*	33-14043	37
31-1A020	50*	31-38242-K04	145	31-64232-K16	147	31-6AR26	49*	33-14045	37
31-1A020-B	50*	31-38243-K04	145	31-64233-K16	147	31-94172-K07	149	33-14047	37
31-1A020-T	50*	31-38245-K04	145	31-64237-K16	147	31-94173-K07	149	33-14058-S82	169
31-1A021	50*	31-38247-K04	145	31-64242-K04	147	31-94175-K07	149	33-14072	37
31-1A024	50*	31-38931	121	31-64243-K04	147	31-94176-K07	149	33-14073	37
31-1A053-080-1	38*	31-38940	121	31-64245-K04	147	31-94182-K14	149	33-14075	37
31-1A053-080-114	38	31-38941	121	31-64247-K04	147	31-94183-K14	149	33-14076	37
31-1A053-080-12	38	31-38950	115	31-68172-K07	147	31-94187-K14	149	33-14142	37
31-1A053-080-34	38	31-38951	115	31-68173-K07	147	31-94232-K16	149	33-14143	37
31-1A126	38*	31-38960	115	31-68175-K07	147	31-94233-K16	149	33-14147	37
31-1A226	38*	31-38961	115	31-681736-K07	147	31-94237-K16	149	33-14158-S69	169
31-1A583	49*	31-38970	115	31-68182-K14	147	31-94242-K04	149	33-14162	37
31-1AB26	49*	31-3A010	49*	31-68183-K14	147	31-94243-K04	149	33-14163	37
31-1AC26	49*	31-3A010-B	49*	31-68187-K14	147	31-94245-K04	149	33-14167	37
31-1AF26	49*	31-3A010-T	49*	31-68232-K16	147	31-94247-K04	149	33-14209	169
31-1AN26	49*	31-3A011-380	49*	31-68233-K16	147	31-98172-K07	149	33-18042	37
31-1AR26	49*	31-3A014	49*	31-68237-K16	147	31-98173-K07	149	33-18043	37
31-211	48*	31-3A020	50*	31-68242-K04	147	31-98175-K07	149	33-18045	37
31-2A126	48*	31-3A020-B	50*	31-68243-K04	147	31-98176-K07	149	33-18047	37
31-311	114*	31-3A020-T	50*	31-68245-K04	147	31-98182-K14	149	33-18058-S82	169
31-34172-K07	145	31-3A021-380	50*	31-68247-K04	147	31-98183-K14	149	33-18072	37
31-34173-K07	145	31-3A024	50*	31-6A010	49*	31-98187-K14	149	33-18073	37
31-34175-K07	145	31-3A026	123	31-6A010-B	49*	31-98232-K16	149	33-18075	37
31-34176-K07	145	31-3A053-080-1	40*	31-6A010-C-B	49	31-98233-K16	149	33-18076	37
31-34182-K14	145	31-3A053-080-114	40	31-6A010-C-T	49	31-98237-K16	149	33-18142	37
31-34183-K14	145	31-3A053-080-12	40	31-6A010-T	49*	31-98242-K04	149	33-18143	37
31-34187-K14	145	31-3A053-080-34	40	31-6A011	49*	31-98243-K04	149	33-18147	37
31-34232-K16	145	31-3A126	40*	31-6A011-C	49	31-98245-K04	149	33-18158-S69	169
31-34233-K16	145	31-3A226	40*	31-6A014	49*	31-98247-K04	149	33-18162	37
31-34237-K16	145	31-3A583	49*	31-6A020	50*	31-9A010	49*	33-18163	37
31-34242-K04	145	31-3A910-263	123	31-6A020-B	50*	31-9A010-B	49*	33-18167	37
31-34243-K04	145	31-3A911	123	31-6A020-C	50	31-9A010-T	49*	33-18209	169
31-34245-K04	145	31-3A911-172	123	31-6A020-C-B	50	31-9A014	49*	33-34042	39
31-34247-K04	145	31-3A919	123	31-6A020-C-T	50	31-9A020	50*	33-34043	39
31-34931	121	31-3A920-263	124	31-6A020-T	50*	31-9A020-B	50*	33-34045	39
31-34940	121	31-3A921	124	31-6A021	50*	31-9A020-T	50*	33-34047	39

Note: * This part number is also displayed on other pages.

Parts Index

Part Number	Pages	Part Number	Pages	Part Number	Pages	Part Number	Pages	Part Number	Pages
33-34058-S82	169	33-38531	119	33-67167-42X	186	33-97072-12X	186	37-27046-22X	186
33-34072	39	33-38540	119	33-68042	41	33-97076-22X	186	37-27047-42X	186
33-34073	39	33-38541	119	33-68043	41	33-97142-12X	186	37-27072-12X	186
33-34075	39	33-38550	119	33-68045	41	33-97143-32X	186	37-27076-22X	186
33-34076	39	33-38551	119	33-68047	41	33-97146-22X	186	37-27162-12X	186
33-34142	39	33-38560	119	33-68058-S82	169	33-97147-42X	186	37-27163-32X	186
33-34143	39	33-38561	119	33-68072	41	33-97162-12X	186	37-27166-22X	186
33-34147	39	33-38570	119	33-68073	41	33-97163-32X	186	37-27167-42X	186
33-34158-S69	169	33-64042	41	33-68075	41	33-97166-22X	186	37-28042	47
33-34162	39	33-64043	41	33-68076	41	33-97167-42X	186	37-28043	47
33-34163	39	33-64045	41	33-68142	41	33-98042	45	37-28045	47
33-34167	39	33-64047	41	33-68143	41	33-98043	45	37-28047	47
33-34209	169	33-64058-S82	169	33-68147	41	33-98045	45	37-28072	47
33-34531	119	33-64072	41	33-68158-S69	169	33-98047	45	37-28073	47
33-34540	119	33-64073	41	33-68162	41	33-98058-S82	169	37-28075	47
33-34541	119	33-64075	41	33-68163	41	33-98072	45	37-28076	47
33-34550	119	33-64076	41	33-68167	41	33-98073	45	37-28162	47
33-34551	119	33-64142	41	33-68172-C-K07	43	33-98075	45	37-28163	47
33-34560	119	33-64143	41	33-68173-C-K07	43	33-98076	45	37-28167	47
33-34561	119	33-64147	41	33-68175-C-K07	43	33-98142	45	37-34531	119
33-34570	119	33-64158-569	165	33-68176-C-K07	43	33-98143	45	37-34540	119
33-37042-12X	186	33-64162	41	33-68182-C-K14	43	33-98147	45	37-34541	119
33-37043-32X	186	33-64163	41	33-68183-C-K14	43	33-98162	45	37-34550	119
33-37046-22X	186	33-64167	41	33-68187-C-K14	43	33-98163	45	37-34551	119
33-37047-42X	186	33-64172-C-K07	43	33-68209	169	33-98167	45	37-34560	119
33-37072-12X	186	33-64173-C-K07	43	33-68232-C-K16	43	33-98209	169	37-34561	119
33-37076-22X	186	33-64175-C-K07	43	33-68233-C-K16	43	36-9A126	44	37-34570	119
33-37142-12X	186	33-64176-C-K07	43	33-68237-C-K16	43	36-M0361-XXX	92	37-38531	119
33-37143-32X	186	33-64182-C-K14	43	33-68242-C-K04	43	36-M1361-XXX	92	37-38540	119
33-37146-22X	186	33-64183-C-K14	43	33-68243-C-K04	43	36-M3361-XXX	92	37-38541	119
33-37147-42X	186	33-64187-C-K14	43	33-68245-C-K04	43	36-M6361-XXX	92	37-38550	119
33-37162-12X	186	33-64209	165	33-68247-C-K04	43	36-M7361	92	37-38551	119
33-37163-32X	186	33-64232-C-K16	43	33-94042	45	36-M9361	92	37-38560	119
33-37166-22X	186	33-64233-C-K16	43	33-94043	45	36-N0241-XXX	92	37-38561	119
33-37167-42X	186	33-64237-C-K16	43	33-94045	45	36-N1241-XXX	92	37-38570	119
33-38042	39	33-64242-C-K04	43	33-94047	45	36-N3241-XXX	92	37-64042	41
33-38043	39	33-64243-C-K04	43	33-94058-S82	169	36-N6241-XXX	92	37-64043	41
33-38045	39	33-64245-C-K04	43	33-94072	45	36-N7241	92	37-64045	41
33-38047	39	33-64247-C-K04	43	33-94073	45	36-N9241	92	37-64047	41
33-38058-S82	169	33-67042-12X	186	33-94075	45	37-24042	47	37-64058-S82	169
33-38072	39	33-67043-32X	186	33-94076	45	37-24043	47	37-64072	41
33-38073	39	33-67046-22X	186	33-94142	45	37-24045	47	37-64073	41
33-38075	39	33-67047-42X	186	33-94143	45	37-24047	47	37-64075	41
33-38076	39	33-67072-12X	186	33-94147	45	37-24072	47	37-64076	41
33-38142	39	33-67076-22X	186	33-94162	45	37-24073	47	37-64142	41
33-38143	39	33-67142-12X	186	33-94163	45	37-24075	47	37-64143	41
33-38147	39	33-67143-32X	186	33-94167	45	37-24076	47	37-64147	41
33-38158-S69	169	33-67146-22X	186	33-94209	169	37-24162	47	37-64158-S69	169
33-38162	39	33-67147-42X	186	33-97042-12X	186	37-24163	47	37-64162	41
33-38163	39	33-67162-12X	186	33-97043-32X	186	37-24167	47	37-64163	41
33-38167	39	33-67163-32X	186	33-97046-22X	186	37-27042-12X	186	37-64167	41
33-38209	169	33-67166-22X	186	33-97047-42X	186	37-27043-32X	186	37-64172-C-K07	43

Part Number	Pages	Part Number	Pages	Part Number	Pages	Part Number	Pages	Part Number	Pages
37-64173-C-K07	43	37-68232-C-K16	43	37-C4003-SS	109	39-38940	121	39-94243-K04	149
37-64175-C-K07	43	37-68233-C-K16	43	37-C8003-SS	109	39-38941	121	39-94245-K04	149
37-64176-C-K07	43	37-68237-C-K16	43	39-1A053-080-SS-1	106	39-38950	121	39-94247-K04	149
37-64182-C-K14	43	37-68242-C-K04	43	39-24232-K16	151	39-38951	121	39-98022-K14	149
37-64183-C-K14	43	37-68243-C-K04	43	39-24233-K16	151	39-38960	121	39-98023-K14	149
37-64187-C-K14	43	37-68245-C-K04	43	39-24237-K16	151	39-38961	121	39-98027-K14	149
37-64209	169	37-68247-C-K04	43	39-24242-K04	151	39-38970	121	39-98061	117
37-64232-C-K16	43	37-94042	45	39-24243-K04	151	39-3A053-080-1	114	39-98172-K07	149
37-64233-C-K16	43	37-94043	45	39-24245-K04	151	39-3A053-080-SS-1	110	39-98173-K07	149
37-64237-C-K16	43	37-94045	45	39-24247-K04	151	39-64172-K07	147	39-98175-K07	149
37-64242-C-K04	43	37-94047	45	39-28232-K16	151	39-64173-K07	147	39-98176-K07	149
37-64243-C-K04	43	37-94072	45	39-28233-K16	151	39-64175-K07	147	39-98232-K16	149
37-64245-C-K04	43	37-94073	45	39-28237-K16	151	39-64176-K07	147	39-98233-K16	149
37-64247-C-K04	43	37-94075	45	39-28242-K04	151	39-64232-K16	147	39-98237-K16	149
37-67042-12X	186	37-94076	45	39-28243-K04	151	39-64233-K16	147	39-98242-K04	149
37-67043-32X	186	37-94142	45	39-28245-K04	151	39-64237-K16	147	39-98243-K04	149
37-67046-22X	186	37-94143	45	39-28247-K04	151	39-64242-K04	147	39-98245-K04	149
37-67047-42X	186	37-94147	45	39-2A010	49*	39-64243-K04	147	39-98247-K04	149
37-67072-12X	186	37-94162	45	39-2A010-B	49*	39-64245-K04	147	39-9A011	49*
37-67076-22X	186	37-94163	45	39-2A010-T	49*	39-64247-K04	147	39-9A014	49*
37-67142-12X	186	37-94167	45	39-2A011	49*	39-68172-K07	147	39-9A014-486	116*
37-67143-32X	186	37-94209	169	39-2A014	49*	39-68173-K07	147	39-9A021	50*
37-67146-22X	186	37-97042-12X	186	39-2A014-486	48*	39-68175-K07	147	39-9A024	50*
37-67147-42X	186	37-97043-32X	186	39-2A020	50*	39-68176-K07	147	39-9A024-486	116*
37-67162-12X	186	37-97046-22X	186	39-2A020-B	50*	39-68232-K16	147	39-9A053-080-112	46
37-67163-32X	186	37-97047-42X	186	39-2A020-T	50*	39-68233-K16	147	39-9A053-080-114	46
37-67166-22X	186	37-97072-12X	186	39-2A021	50*	39-68237-K16	147	39-9A053-080-2	46*
37-67167-42X	186	37-97076-22X	186	39-2A024	50*	39-68242-K04	147	39-9A053-080-212	46
37-68042	41	37-97142-12X	186	39-2A024-486	48*	39-68243-K04	147	39-9A110	49*
37-68043	41	37-97143-32X	186	39-2A026	123*	39-68245-K04	147	39-9A220	154
37-68045	41	37-97146-22X	186	39-2A053-080-112	48	39-68247-K04	147	39-9A486	46*
37-68047	41	37-97147-42X	186	39-2A053-080-2	48	39-6A014	49*	39-9A523	49*
37-68058-S82	169	37-97162-12X	186	39-2A053-080-212	48*	39-6A024	50*	39-9A583	49*
37-68072	41	37-97163-32X	186	39-2A110	49*	39-6A053-080-1	42*	39-9A677	49*
37-68073	41	37-97166-22X	186	39-2A220	50*	39-6A053-080-112	42*	3H1	58*
37-68075	41	37-97167-42X	186	39-2A486	48*	39-6A053-080-114	42*	3H112	58
37-68076	41	37-98042	45	39-2A523	49*	39-6A053-080-2	42*	3H114	58*
37-68142	41	37-98043	45	39-2A583	49*	39-6A110	49*	3H12	58*
37-68143	41	37-98045	45	39-2AB26	49*	39-6A220	50	3H1SS	110
37-68147	41	37-98047	45	39-2AC26	49*	39-6A220-C	50	3H34	58*
37-68158-S69	169	37-98072	45	39-2AF26	49*	39-6A523	49*	3PH1	40*
37-68162	41	37-98073	45	39-2AN26	49*	39-6A583	49*	3PH114	40*
37-68163	41	37-98075	45	39-2AR26	49*	39-6A677	49*	3PH12	40*
37-68167	41	37-98076	45	39-34931	121	39-94061	117	3PH34	40*
37-68172-C-K07	43	37-98142	45	39-34940	121	39-94172-K07	149	3PM514	30*
37-68173-C-K07	43	37-98143	45	39-34941	121	39-94173-K07	149	3PM516	30*
37-68175-C-K07	43	37-98147	45	39-34950	121	39-94175-K07	149	3PM518	30*
37-68176-C-K07	43	37-98162	45	39-34951	121	39-94176-K07	149	3PM520	30*
37-68182-C-K14	43	37-98163	45	39-34960	121	39-94232-K16	149	3PM522	30*
37-68183-C-K14	43	37-98209	169	39-34961	121	39-94233-K16	149	4-0201-A	187
37-68187-C-K14	43	37-B4002-SS	105	39-34970	121	39-94237-K16	149	4-0201-B	187
37-68209	169	37-B8002-SS	105	39-38931	121	39-94242-K04	149	4-0201-C	187

Note: * This part number is also displayed on other pages.

Parts Index

Part Number	Pages	Part Number	Pages	Part Number	Pages	Part Number	Pages	Part Number	Pages
4-0201-D	187	42-4100P-50P	96	47-34143	129	49-3A020	131	49-68042	129
4-0301-E	187	42-4100M-50P	96	47-34145	129	49-3A021	131	49-68043	129
4-0301-F	187	42-41001-63P	96	47-34146	129	49-3A021N	131	49-68045	129
4-0301-G	187	42-41002-63P	96	47-34147	129	49-3A024	131	49-68046	129
4-0501-H	187	42-41003-63P	96	47-38042	129	49-3A029	131	49-68047	129
4-0501-J	187	42-4100N-63P	96	47-38043	129	49-3A126	130	49-68142	129
4-2301-A	187	42-4100T-63P	96	47-38045	129	49-3A913-XXX	130	49-68143	129
4-2301-B	187	42-4100P-63P	96	47-38046	129	49-3A925	130*	49-68145	129
4-2301-C	187	42-4100M-63P	96	47-38047	129	49-44042	129	49-68146	129
4-2301-D	187	42-47001	96	47-38142	129	49-44043	129	49-68147	129
4-2401-A	187	42-47002	96	47-38143	129	49-44045	129	49-6A010	131
4-2401-B	187	42-47003	96	47-38145	129	49-44046	129	49-6A011	131
4-2401-C	187	42-4700N	96	47-38146	129	49-44047	129	49-6A011N	131
4-2401-D	187	42-4700T	96	47-38147	129	49-44142	129	49-6A013-XXX	130
4-2901-A	187	42-4700P	96	47-3A010	131	49-44143	129	49-6A014	131
4-2901-B	187	42-4700M	96	47-3A011	131	49-44145	129	49-6A019	131
4-2901-C	187	45-4A027	135	47-3A011N	131	49-44146	129	49-6A020	131
4-2901-D	187	45-4A12C	135	47-3A013-XXX	131	49-44147	129	49-6A021	131
4-3301-E	187	45-4A12 D	135	47-3A014	131	49-48042	129	49-6A021N	131
4-3301-F	187	45-4A15 C	135	47-3A019	131	49-48043	129	49-6A024	131
4-3301-G	187	45-4A15 D	135	47-3A020	131	49-48045	129	49-6A029	131
4-3401-E	187	45-4A18 C	135	47-3A021	131	49-48046	129	49-6A126	131
4-3401-F	187	45-4A18 D	135	47-3A021N	131	49-48047	129	49-6A913-XXX	130
4-3401-G	187	45-4A24 C	135	47-3A024	131	49-48142	129	49-6A925	131
4-3901-E	187	45-4A24 D	135	47-3A029	131	49-48143	129	4CN30	108
4-3901-F	187	45-4A30 C	135	47-3A126	130	49-48145	129	5-0205-A	188
4-3901-G	187	45-4A30 D	135	47-3A913-XXX	130	49-48146	129	5-0205-B	188
4-5301-H	187	45-4A40 C	135	47-3A925	130*	49-48147	129	5-0205-C	188
4-5301-J	187	45-4A40 D	135	49-34042	129	49-4A010	131	5-0205-D	188
4-5401-H	187	45-4A753	135	49-34043	129	49-4A011	131	5-0205-K	188
4-5401-J	187	45-4A95 C	135	49-34045	129	49-4A011N	131	5-0206-A	188
4-5901-H	187	45-4A95 D	135	49-34046	129	49-4A013-XXX	130	5-0206-B	188
4-5901-J	187	45-44001-P80	135	49-34047	129	49-4A014	131	5-0206-C	188
42-41001-32P	96	45-44002-P80	135	49-34142	129	49-4A019	131	5-0206-D	188
42-41002-32P	96	45-44003-P80	135	49-34143	129	49-4A020	131	5-0206-K	188
42-41003-32P	96	45-4400M-P80	135	49-34145	129	49-4A021	131	5-0207-A	188
42-4100N-32P	96	45-4400N-P80	135	49-34146	129	49-4A021N	131	5-0207-B	188
42-4100T-32P	96	45-4400P-P80	135	49-34147	129	49-4A024	131	5-0207-C	188
42-4100P-32P	96	45-4400T-P80	135	49-38042	129	49-4A029	131	5-0207-D	188
42-4100M-32P	96	45-48001-P80	135	49-38042	129	49-4A126	130	5-0207-K	188
42-41001-40P	96	45-48002-P80	135	49-38043	129	49-4A913-XXX	130	5-2105-A	188
42-41002-40P	96	45-48003-P80	135	49-38045	129	49-4A925	130	5-2105-B	188
42-41003-40P	96	45-4800M-P80	135	49-38046	129	49-64042	129	5-2105-C	188
42-4100N-40P	96	45-4800N-P80	135	49-38047	129	49-64043	129	5-2105-D	188
42-4100T-40P	96	45-4800P-P80	135	49-38142	129	49-64045	129	5-2105-K	188
42-4100P-40P	96	45-4800T-P80	135	49-38143	129	49-64046	129	5-2106-A	188
42-4100M-40P	96	47-34042	129	49-38145	129	49-64047	129	5-2106-B	188
42-41001-50P	96	47-34043	129	49-38146	129	49-64142	129	5-2106-C	188
42-41002-50P	96	47-34045	129	49-38147	129	49-64143	129	5-2106-D	188
42-41003-50P	96	47-34046	129	49-3A011	130	49-64145	129	5-2106-K	188
42-4100N-50P	96	47-34047	129	49-3A013-XXX	130	49-64146	129	5-2107-A	188
42-4100T-50P	96	47-34142	129	49-3A014	131	49-64147	129	5-2107-B	188

Part Number	Pages	Part Number	Pages	Part Number	Pages	Part Number	Pages	Part Number	Pages
5-2107-C	188	61-3A053-080-12	28	63-14075	25	63-64142	29	89-38042	57
5-2107-D	188	61-3A053-080-34	28	63-14076	25	63-64143	29	89-38043	57
5-2107-K	188	61-3A126	28*	63-14162	25	63-64147	29	89-38045	57
61-1A010	31	61-3A346	28*	63-14163	25	63-64162	29	89-38047	57
61-1A010-B	31	61-3A826	28*	63-14167	25	63-64163	29	89-38072	57
61-1A010-T	31	61-3AB26	31*	63-18042	25	63-64167	29	89-38073	57
61-1A011	31	61-3AC26	31*	63-18043	25	63-68042	29	89-38075	57
61-1A013	26	61-3AF26	31*	63-18045	25	63-68043	29	89-38076	57
61-1A013-1	26	61-3AM26	123*	63-18047	25	63-68045	29	89-38142	57
61-1A013-12	26	61-3AN26	31*	63-18072	25	63-68047	29	89-38143	57
61-1A013-34	26	61-3AR26	31*	63-18073	25	63-68072	29	89-38147	57
61-1A014	31	61-6A010	31	63-18075	25	63-68073	29	89-38162	57
61-1A020	32	61-6A010-B	31	63-18076	25	63-68075	29	89-38163	57
61-1A020-B	32	61-6A010-T	31	63-18162	25	63-68076	29	89-38167	57
61-1A020-T	32	61-6A013	30*	63-18163	25	63-68142	29	89-3A010	63
61-1A021	32	61-6A013-1	30*	63-18167	25	63-68143	29	89-3A010-172	63
61-1A023-12	26	61-6A013-114	30*	63-34042	27	63-68147	29	89-3A010-B	63
61-1A023-34	26	61-6A013-12	30*	63-34043	27	63-68162	29	89-3A010-T	63
61-1A024	32	61-6A013-34	30*	63-34045	27	63-68163	29	89-3A010-T-172	63
61-1A027	26	61-6A014	31*	63-34047	27	63-68167	29	89-3A011	63
61-1A053-080-1	26	61-6A020	32	63-34072	27	63-B4002	103	89-3A014	63
61-1A053-080-114	26	61-6A020-B	32	63-34073	27	63-B8002	103	89-3A019	63
61-1A053-080-12	26	61-6A020-T	32	63-34075	27	63-C4003	107	89-3A020	64
61-1A053-080-34	26	61-6A023-1	30*	63-34076	27	63-C8003	107	89-3A020-172	64
61-1A126	26	61-6A023-12	30*	63-34142	27	6H1	42*	89-3A020-B	64
61-1A313	26	61-6A023-34	30*	63-34143	27	6H112	42*	89-3A020-T	64
61-1A346	26*	61-6A024	32	63-34147	27	6H114	42*	89-3A020-T-172	64
61-1A583	31*	61-6A027	30*	63-34162	27	6H12	42*	89-3A021	64
61-1A826	26	61-6A053-080-1	30*	63-34163	27	6H34	42*	89-3A021N	64
61-1AB26	31*	61-6A053-080-114	30	63-34167	27	6PH1	42*	89-3A024	64
61-1AC26	31*	61-6A053-080-12	30	63-38042	27	6PH112	42*	89-3A026	63*
61-1AF26	31*	61-6A053-080-34	30	63-38043	27	6PH114	42*	89-3A027	30*
61-1AM26	123*	61-6A126	30*	63-38045	27	6PH12	42*	89-3A029	64
61-1AR26	31*	61-6A346	30*	63-38047	27	6PH34	42*	89-3A053-080-1	58
61-3A010	31	61-6A473	30*	63-38072	27	6PM622	42*	89-3A053-080-114	58
61-3A010-B	31	61-6A826	30*	63-38073	27	6PM625	42*	89-3A053-080-12	58
61-3A010-T	31	61-BA113	123	63-38075	27	6PM627	42*	89-3A053-080-34	58
61-3A013	28*	61-BA213	124	63-38076	27	6PM629	42*	89-3A126	58
61-3A013-1	28*	61-BA910	123	63-38142	27	89-34042	57	89-3A219-172	63
61-3A013-114	28*	61-BA920	124	63-38143	27	89-34043	57	89-3A229-172	64
61-3A013-12	28*	61-CA113	123	63-38147	27	89-34045	57	89-3A523	63
61-3A013-34	28*	61-CA500	100	63-38162	27	89-34047	57	89-3A925	64
61-3A014	31*	61-CA910	123	63-38163	27	89-34072	57	89-64042	59
61-3A020	32	61-CA920	124	63-38167	27	89-34073	57	89-64043	59
61-3A020-B	32	63-08231	103	63-64042	29	89-34075	57	89-64045	59
61-3A020-T	32	63-08240	103	63-64043	29	89-34076	57	89-64047	59
61-3A023-12	28*	63-14042	25	63-64045	29	89-34142	57	89-64072	59
61-3A023-34	28*	63-14043	25	63-64047	29	89-34143	57	89-64073	59
61-3A024	32*	63-14045	25	63-64072	29	89-34147	57	89-64075	59
61-3A027	28*	63-14047	25	63-64073	29	89-34162	57	89-64076	59
61-3A053-080-1	28*	63-14072	25	63-64075	29	89-34163	57	89-64142	59
61-3A053-080-114	28	63-14073	25	63-64076	29	89-34167	57	89-64143	59

Note: * This part number is also displayed on other pages.

Parts Index

Part Number	Pages	Part Number	Pages	Part Number	Pages	Part Number	Pages	Part Number	Pages
89-64147	59	89-94075	61	9H114	46*	CG123P	193	CG345AM	193
89-64162	59	89-94076	61	9H2	46*	CG123PM	193	CG345P	193
89-64163	59	89-94142	61	9H34	46*	CG124A	193	CG345PM	193
89-64167	59	89-94143	61	9PH1	46*	CG124AM	193	CPF403	131
89-68042	59	89-94147	61	9PH112	46*	CG124P	193	CPF405	131
89-68043	59	89-94162	61	9PH114	46*	CG124PM	193	DN16R	114
89-68045	59	89-94163	61	9PH2	46*	CG125A	193	DN63R	116*
89-68047	59	89-94167	61	9PH34	46*	CG125AM	193	DS1PC	38*
89-68072	59	89-98042	61	9PM622	46*	CG125P	193	DS2MC	48*
89-68073	59	89-98043	61	9PM625	46*	CG125PM	193	DS3PC	40*
89-68075	59	89-98045	61	9PM627	46*	CG2001A	194	DS6MC	42*
89-68076	59	89-98047	61	9PM629	46*	CG2001AM	194	DS9MC	46*
89-68142	59	89-98072	61	CG1001A	193	CG2001P	194	FDP2	38*
89-68143	59	89-98073	61	CG1001AM	193	CG2002A	194	FDP3	40*
89-68147	59	89-98075	61	CG1001P	193	CG2002AM	194	FDP6	42*
89-68162	59	89-98076	61	CG1002A	193	CG2002P	194	FDP9SS	46
89-68163	59	89-98142	61	CG1002AM	193	CG2003A	194	FH111	38*
89-68167	59	89-98143	61	CG1002P	193	CG2003AM	194	FH311	40*
89-6A010	63	89-98147	61	CG1003A	193	CG2003P	194	FH311-473	40*
89-6A010-172	63	89-98162	61	CG1003P	193	CG2004A	194	FH611	42*
89-6A010-B	63	89-98163	61	CG1004P	193	CG2004AM	194	FH611-473	42*
89-6A010-T	63	89-98167	61	CG1121A	193	CG2005A	194	H091U1	94*
89-6A010-T-172	63	89-9A010	63	CG1121AM	193	CG2005AM	194	H091U1-185	162
89-6A011	63	89-9A010-174	63	CG1121P	193	CG2006A	194	H091U12	94*
89-6A014	63	89-9A010-B	63	CG1122A	193	CG2006AM	194	H091U12-185	162
89-6A019	63	89-9A010-T	63	CG1122AM	193	CG2121A	194	H091U34	94*
89-6A020	64	89-9A010-T-174	63	CG1122P	193	CG2121AM	194	H091U34-185	162
89-6A020-172	64	89-9A011	63	CG1123A	193	CG2122A	194	MA1	26
89-6A020-B	64	89-9A014	63	CG1123AM	193	CG2122AM	194	MA10	46*
89-6A020-T	64	89-9A019	63	CG1124A	193	CG2123A	194	MA110	46*
89-6A020-T-172	64	89-9A020	64	CG1124AM	193	CG2123AM	194	MA2	28*
89-6A021	64	89-9A020-174	64	CG1141A	193	CG3001A	194	MA20	48*
89-6A021N	64	89-9A020-B	64	CG1141AM	193	CG3001AM	194	MA220	48*
89-6A024	64	89-9A020-T	64	CG1141P	193	CG3002A	194	MA2SS	100
89-6A026	63*	89-9A020-T-174	64	CG1142A	193	CG3002AM	194	MA3	30*
89-6A027	42*	89-9A021	64	CG1142AM	193	CG340A	193	MA3SS	110
89-6A029	64	89-9A021N	64	CG1142P	193	CG340AM	193	MA6	42*
89-6A053-080-1	60	89-9A024	64	CG1143A	193	CG340P	193	MA660	42*
89-6A053-080-112	60	89-9A026	63*	CG1143AM	193	CG340PM	193	MAB6	42*
89-6A053-080-114	60	89-9A027	46*	CG1143P	193	CG341A	193	MAFS1	26
89-6A053-080-2	60	89-9A029	64	CG1144A	193	CG341AM	193	MAFS2	28*
89-6A126	60	89-9A053-080-112	62	CG1144AM	193	CG341P	193	MAFS3	30*
89-6A219-172	63	89-9A053-080-114	62	CG121A	193	CG341PM	193	MB10112	46*
89-6A229-172	64	89-9A053-080-2	62	CG121AM	193	CG342A	193	MB10114	46*
89-6A523	63	89-9A126	62	CG121P	193	CG342AM	193	MB102	46*
89-6A925	64	89-9A219-174	63	CG121PM	193	CG342P	193	MB10212	46*
89-94042	61	89-9A229-174	64	CG122A	193	CG342PM	193	MB20112	48*
89-94043	61	89-9A523	63	CG122AM	193	CG344A	193	MB202	48*
89-94045	61	89-9A925	64	CG122P	193	CG344AM	193	MB20212	48*
89-94047	61	9-LD12-37	108	CG122PM	193	CG344P	193	MB22212	48*
89-94072	61	9H1	46*	CG123A	193	CG344PM	193	MB31	26*
89-94073	61	9H112	46*	CG123AM	193	CG345A	193	MB3114	30*

Part Number	Pages	Part Number	Pages	Part Number	Pages	Part Number	Pages	Part Number	Pages
MB3114-601	26	RBT1-C2-077-20A	182						
MB312	30*	RBT1-C2-077-30A	182						
MB312-601	26*	RBT1-C2-077-60A	182						
MB312-NP	162	RBT1-C2-167-20A	182						
MB314-NP	162	RBT1-C2-167-30A	182						
MB31-601	26	RBT1-C2-167-60A	182						
MB31-NP	162	RBT1-C3-077	182						
MB334	30*	RBT1-C3-167	182						
MB334-601	26	RBT2-C1-077	183						
MB334-NP	162	RBT2-C1-167	183						
MB40PFQ-XX	130	RBT2-C2-077-20A	183						
MB40-XX	130	RBT2-C2-077-30A	183						
MB61	42*	RBT2-C2-167-20A	183						
MB6112	42*	RBT2-C2-167-30A	183						
MB6114	42*	RBT3-C1-077	184						
MB62	42*	RBT3-C1-167	184						
MC212	38*	RBT3-C2-077-20A	184						
MC234	38*	RBT3-C2-077-30A	184						
MC31	146	RBT3-C2-167-20A	184						
MC312	146	RBT3-C2-167-30A	184						
MC61	42*								
MC6114	42*								
MC612	42*								
MC634	42*								
MP10	46*								
MP2	38*								
MP3	40*								
MP6	42*								
MS1	26								
MS10	46*								
MS2	28*								
MS20	118								
MS210	152								
MS3	30*								
MS6	42*								
MSPN	26*								
MSPN-185	162								
NT100	46*								
NT110	46*								
NT120	46*								
NT200	48*								
NT210	48*								
NT220	48*								
RBT1-C1-043-20A	182								
RBT1-C1-043-30A	182								
RBT1-C1-043-60A	182								
RBT1-C1-077-20A	182								
RBT1-C1-077-30A	182								
RBT1-C1-077-60A	182								
RBT1-C1-167-20A	182								
RBT1-C1-167-30A	182								
RBT1-C1-167-60A	182								

Note: * This part number is also displayed on other pages.

Literature & Website



Meltric Corporation is pleased to be able to offer an extensive line of informational material including industry specific brochures, an electrical safety brochure, motor installation guide, and a number of other flyers that will further explain how Meltric products can contribute to the safe and efficient operation of industrial or commercial facilities.

To order any of our literature, please make a copy of the opposite page and mail or fax it to Meltric.



All Meltric literature is available upon request and can be easily downloaded from our website at meltric.com.

Literature Request



4640 Ironwood Drive • Franklin, WI 53132
 800.433.7642 • 414.817.6160 • Fax 414.817.6161
 mail@meltric.com • meltric.com



Literature		Quantity
<input type="checkbox"/>	2013-2014 Main Catalog	CATALOG2013 _____
<input type="checkbox"/>	Current Price List	PRICELIST2013 _____
<input type="checkbox"/>	DECONTACTOR Brochure	DECONTACTOR _____
<input type="checkbox"/>	Safety Guide	SAFETYGUIDE _____
<input type="checkbox"/>	Wastewater Industry Brochure	WWSOLNS _____
<input type="checkbox"/>	Food & Beverage Industry Brochure	FOODBEVERAGE _____
<input type="checkbox"/>	Mining and Aggregate Industry Brochure	AGGMINING _____
<input type="checkbox"/>	Power Generation Industry Brochure	PWRGEN _____
<input type="checkbox"/>	Arc Flash Protection Flyer	ARCFLASH _____
<input type="checkbox"/>	Update Your Plugs & Receptacles Flyer	UPDATE _____
<input type="checkbox"/>	Welding Receptacles Flyer	WELDING _____
<input type="checkbox"/>	Generator Plugs Flyer	GENERATOR _____
<input type="checkbox"/>	Custom Power Distribution Flyer	CUSTOMPOWER _____
<input type="checkbox"/>	Motor Plug Brochure	MTRPLUG _____
<input type="checkbox"/>	Motor Connection Guide Flyer	MTRCONNECTION _____
<input type="checkbox"/>	HVAC Quick Disconnect Plug Flyer	HVAC _____
<input type="checkbox"/>	Busway System Plugs & Receptacles Flyer	BUSWAY _____
<input type="checkbox"/>	3 Fold Decontactor Mailer	DECMAILER _____
<input type="checkbox"/>	3 Fold NFPA 70E Mailer	NFPA _____
<input type="checkbox"/>	Simplify CSA Z462 Compliance Flyer	UPDATECSA _____

Name: _____

Company: _____

Address: _____

City: _____ State: _____ Zip: _____

Phone: _____ Fax: _____

E-Mail Address: _____

Notes

WORLDWIDE AVAILABILITY

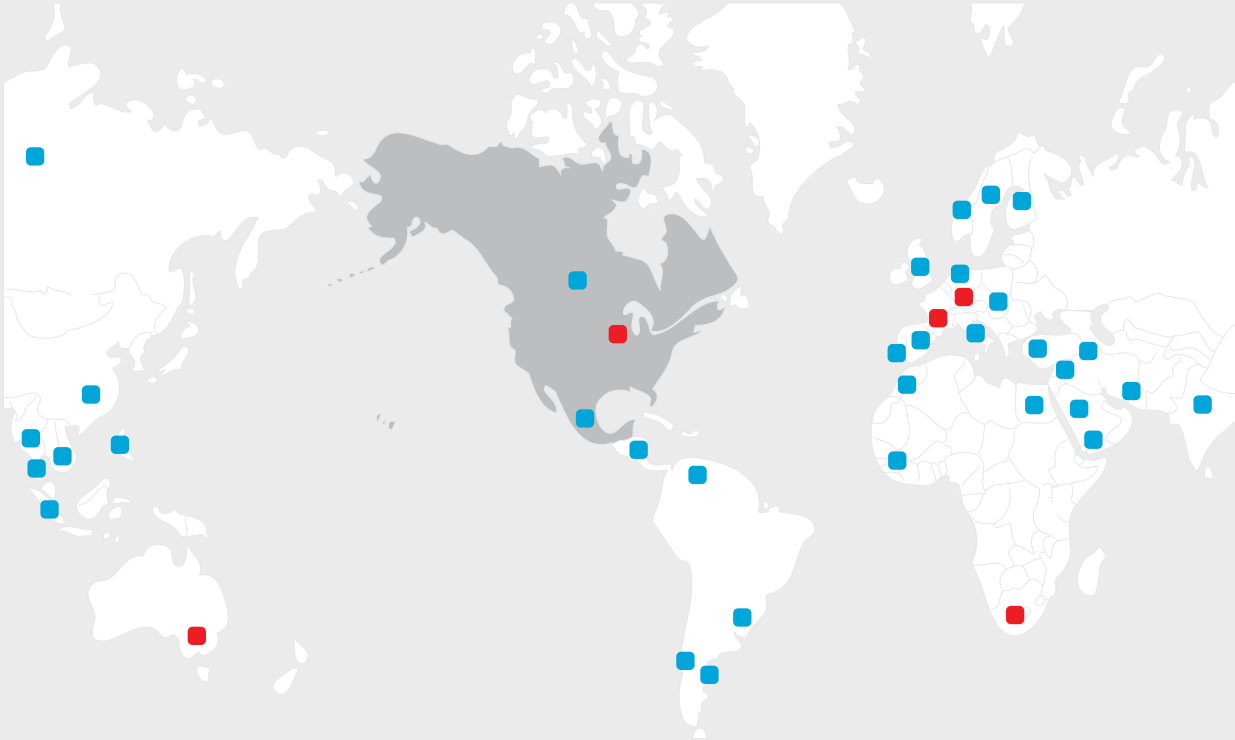

MARECHAL ELECTRIC GROUP



**Thank you for your interest.
For more information, please contact your Meltric Representative...**

USA / CANADA / MEXICO

Meltric Corporation
4640 Ironwood Drive
Franklin, Wisconsin
53132
Tel.: 800.433.7642
Fax: 414.817.6161

meltric.com

 **MELTRIC**
CORPORATION

CATALOG 2013