



# TRAC-MASTER®

One Circuit Trac System

## TRAC SECTION, JOINERS & FEEDS T Series

Project: \_\_\_\_\_

Fixture Type: \_\_\_\_\_

Location: \_\_\_\_\_

Contact/Phone: \_\_\_\_\_

### PRODUCT DESCRIPTION

Low-Profile, single-circuit trac sections for surface or pendant mounting. I-beam cross section provides added strength and rigidity in pendant suspended applications. Compatible with a full range of feed, connector and mounting accessories, as listed on back of this page, to complete virtually any installation requirement. Accepts all Trac-Master and Trac-Lites trac fixtures.

### PRODUCT SPECIFICATIONS

**Construction** Extruded aluminum "I" beam channel • One-piece thermoplastic insulator • Injection molded polycarbonate dead-end with set screw • Standard lengths may be cut-to-length by installer.

**Electrical** Two 12 gauge solid copper conductors • Rated 20 amps at 120 volts • Aluminum channel used as system ground • One-piece insulator insures consistent conductor spacing for reliable electrical contact • Insulating bushings supplied at mounting hole locations to prevent shorts to ground.

**Labels** UL listed, CSA certified.

### PRODUCT INSTALLATION

Debossed polarity line provides visual cue to proper trac, trac connector and fixture alignment • Supplied with toggle bolts for surface mounting • Integral raceway in top of channel accommodates pendant mounting hardware and wire routing to electrical feed • Insulator stays same length as extrusion to simplify field-cutting of trac • Connectors and feeds simply push into trac sections.

Specifications subject to change without notice.

### DIMENSIONS

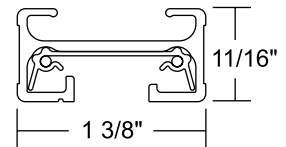
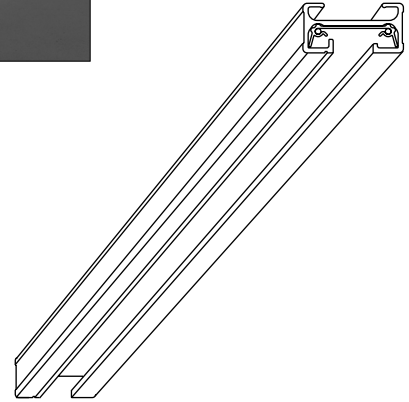
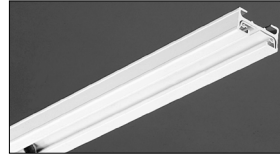

### ORDERING INFORMATION

Example: T 8FT WH

Series	Length	Finish
T Trac-Master 1-Circuit Track Sections	<b>2FT</b> 2-foot track section; actual length 19-7/8"	<b>BL</b> Black
	<b>4FT</b> 4-foot track section; actual length 43-7/8"	<b>NAT</b> Natural
	<b>6FT</b> 6-foot track section; actual length 67-7/8"	<b>SL</b> Silver
	<b>8FT</b> 8-foot track section; actual length 91-7/8"	<b>WH</b> White
	<b>12FT</b> 12-foot track section; actual length 139-7/8"	

# TRAC-MASTER®

One Circuit Trac System

## TRAC SECTION, JOINERS & FEEDS T Series

### Electrical Feeds

Examples: T21 BL, T34 RP WH

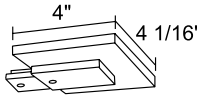
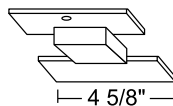
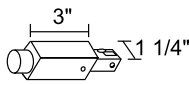
T21	T21 RP	T29	T34	T34 RP
BL, SL, WH	BL, SL, WH	BL, SL, WH	BL, SL, WH	BL, SL, WH
<p><b>End Feed Connector and Outlet Box Cover</b></p> <p>For outlet box feed. Includes: outlet box cover, fixture strap and ground screw.</p> 	<p><b>End Feed Connector and Outlet Box Cover</b></p> <p>Same as T21 except designed for use in opposite polarity orientation compared to standard feed connectors.</p>	<p><b>Floating Electrical Feed</b></p> <p>Permits mounting any point of trac under outlet box. Includes floating connector, outlet box cover plus extra trac dead end.</p> 	<p><b>Conduit End Feed</b></p> <p>For surface wiring. Use standard 1/2" connector.</p> 	<p><b>Conduit End Feed</b></p> <p>Same as T34 except designed for use in opposite polarity orientation compared to standard feed connectors.</p>

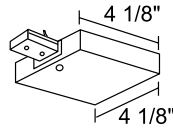
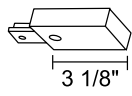
T36	T36 RP	T38	T38 RP
BL, SL, WH	BL, SL, WH	BL, SL, WH	BL, SL, WH
<p><b>T-Bar End Feed</b></p> <p>Wiring compartment contains standard 1/2" KO's. Feeds surface trac from above, when T-bar is directly above trac.</p> 	<p><b>T-Bar End Feed</b></p> <p>Same as T36 except designed for use in opposite polarity orientation compared to standard feed connectors.</p>	<p><b>Live End Feed Connector</b></p> <p>Feed trac from above with flexible conduit, BX, etc., or end feed in pendant systems. Accepts standard 1/2" connector.</p> 	<p><b>Live End Feed Connector</b></p> <p>Same as T38 except designed for use in opposite polarity orientation compared to standard feed connectors.</p>

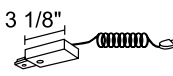
T22	T122
BL, SL, WH	BL, SL, WH
<p><b>Cord and Plug End Feed</b></p> <p>Comes with 15' two-wire white cord. Includes surface wire retainers and in-line switch. Max cap. 7 amps. Not UL Listed.</p> 	<p><b>Cord and Plug End Feed</b></p> <p>Same as T122 but with matching color 3-wire grounded cord and plug. No switch. Not UL Listed.</p>

### Outrigger System

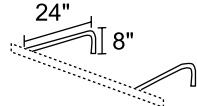
T47
BL, WH
<p><b>Outrigger Bracket (non-electrified)</b></p> <p>For mounting trac out from wall. Use two for 2', 4' or 6' trac sections, three for 8' trac sections and four for 12' trac sections. Order trac and connectors separately. For portable electrical feed, use T22 or T122 Cord &amp; Plug Connector. For permanent wiring, use T38 end feed connector.</p> 

# TRAC-MASTER®

One Circuit Trac System



## TRAC SECTION, JOINERS & FEEDS T Series

### Trac Joiners & Dead End

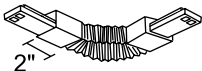
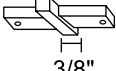
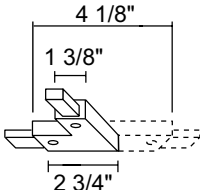
Examples: T20 BL, T25 RP WH

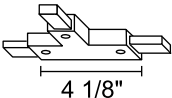
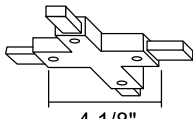
T20	T23	T24N ‡	T24F ‡
BL, SL, WH	BL, SL, WH	BL, SL, WH	BL, SL, WH
<p><b>Accordion Adjustable Joiner</b></p> <p>Can flex to 90° angle to left, right, up or down. Joins two trac sections.</p> 	<p><b>Miniature Straight Connector</b></p> <p>Joins two trac sections end to end.</p> 	<p><b>Adjustable Connector</b></p> <p>Joins two trac sections to make a 90° angle or straight run. Straight and right angle covers supplied. For outlet box feed, No. T27 cover plate required.</p> 	<p><b>Adjustable Connector</b></p> <p>Same as T24 but with integral ground connection. For outlet box feed, No. T27 cover plate required.</p>

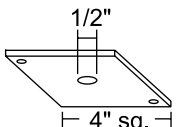
T25 ‡	T25 RP ‡	T25 F ‡	T26 ‡	T26 F ‡
BL, SL, WH	BL, SL, WH	BL, SL, WH	BL, SL, WH	BL, SL, WH
<p><b>"T" Connector</b></p> <p>Joins three trac sections. For outlet box feed, No. T27 cover plate required.</p>	<p><b>"T" Connector</b></p> <p>Same as T25 except designed for use in opposite polarity orientation compared to standard feed connectors.</p> 	<p><b>"T" Connector</b></p> <p>Same as T25 but with integral ground connection. For outlet box feed, No. T27 cover plate required.</p>	<p><b>"X" Connector</b></p> <p>Joins four trac sections at 90° angles. For outlet box feed, T27 cover plate required.</p> 	<p><b>"X" Connector</b></p> <p>Same as T26 but with integral ground connection. For outlet box feed, No. T27 cover plate required.</p>

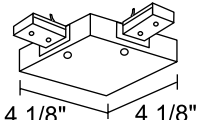
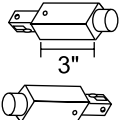
T27	T28	T35	T49
BL, SL, WH	BL, SL, WH	BL, SL, WH	BL, SL, WH
<p><b>Outlet Box Cover</b></p> <p>Use with Nos. T24/T25/T26 for outlet box electrical feed. Includes: nipple, locknut and ground screw.</p> 	<p><b>Trac Dead End</b></p> <p>For use with field-cut trac sections.</p> 	<p><b>T-Bar Adjustable Joiner Feed</b></p> <p>Joins two trac sections to make 90° angle or straight run. Wiring compartment contains standard 1/2" KO's. Feeds from above when T-bar is directly above trac.</p> 	<p><b>Trac Continuation Kit</b></p> <p>Permits trac to continue a run around obstructions. Includes one T34 Conduit Feed and one T34 RP Conduit Feed. Fits standard 1/2" conduit.</p> 

‡ T24N, T25 and T26 may not be used as feed connectors in Canada due to special grounding requirements – T24F, T25F & T26F are approved for use as feed connectors in Canada (may also be used in U.S.).

# TRAC-MASTER®



One Circuit Trac System

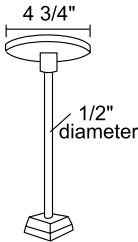
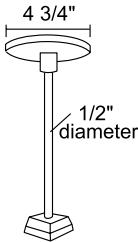
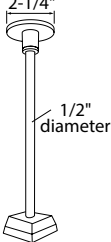

## TRAC SECTION, JOINERS & FEEDS T Series

### Pendant Stems

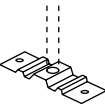
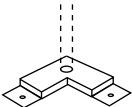
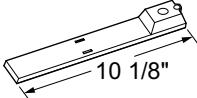
Examples: T90 12IN BL, T93 BL

T90	T91	T9091M
12IN, 18IN, 24IN, 36IN, 48IN	12IN, 18IN, 24IN, 36IN, 48IN	12IN, 18IN, 24IN, 36IN, 48IN
BL, SL, WH	BL, SL, WH	BL, SL, WH
<p><b>T-Bar Pendant Stem Kit</b></p> <p>Compatible with 15/16" flush T-Bar ceilings. Use two for 2', 4', 6' of trac or three for 8' of trac. Includes canopy, T-Bar mounting plate, stem and trac attachment hardware. For electrical feed, order <b>T93</b> wireway cover.</p> 	<p><b>Rigid Ceiling Pendant Stem Kit</b></p> <p>Attaches directly to junction box in rigid ceilings. Use two for 2', 4', 6' of trac or three for 8' of trac. Includes canopy, J-Box mounting strap, stem and trac attachment hardware. For electrical feed, order <b>T93</b> wireway cover.</p> 	<p><b>Pendant Stem Mechanical Support Kit</b></p> <p>For mechanical support only (no feed). Suspends Trac from T-bar or rigid ceilings. Use two for 2', 4', 6' of trac or three for 8' of trac or four for 12' of trac (support is required every 4 feet). Includes Mini-Canopy, pendant stem, 15/16" T-bar clip, drywall anchor and Trac mounting hardware.</p> 

T92	T92 L	T93	T94
	BL, SL, WH	BL, SL, WH	BL, SL, WH
<p><b>Straight Structural Bridge</b></p> <p>For use with <b>T24</b> Straight Connector. Permits mounting Pendant Stem Kits (T90, T91) at center of Trac Joiner.</p> 	<p><b>Corner Structural Bridge</b></p> <p>For use with <b>T24</b> Right Angle Connector. Permits mounting Pendant Stem Kits (T90, T91) at center of Right Angle Connector.</p> 	<p><b>Wireway Cover</b></p> <p>For Pendant Stem Kits <b>T90</b> and <b>T91</b>. Conceals electrical feed wires from stem to connector. One cover required for each trac feed.</p> 	<p><b>Sloped Ceiling Adapter</b></p> <p>Allows <b>T90</b> or <b>T91</b> pendant to hang straight down from sloped ceilings. Can be used to feed electrical wires to Trac at up to 60° angle.</p> 

T96	T56
BL, SL, WH	BL, SL, WH
<p><b>Pendant Stem Threaded Coupling</b></p> <p>Enables multiple pendant stems to be joined for higher ceiling applications.</p> 	<p><b>Solid Rod Pendant Mounting Kit</b></p> <p>Attaches solid 5/16" threaded rod to Trac. Includes: plastic cap, mounting bracket and hardware. Rod not supplied.</p> 

# TRAC-MASTER®

One Circuit Trac System

## TRAC SECTION, JOINERS & FEEDS T Series

### Cable Suspension

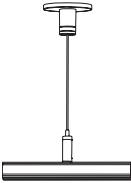
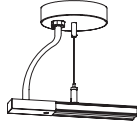

Examples: T595 48IN BL, T598 144IN WH



T595	T597	T596	T598
48IN, 144IN	48IN, 144IN	48IN, 144IN	48IN, 144IN
BL, WH	BL, WH	BL, WH	BL, WH
<p><b>T-Bar Ceiling Cable Suspension Kit</b></p> <p>Mechanical-only cable suspension kit for 1-circuit or 2-circuit trac. Compatible with 15/16" flush T-Bar ceilings. Adjustable 48" or 144" stainless steel cable length. Includes mini-canopy, T-bar clip and cable hardware. Trac requires support every 4'.</p> 	<p><b>Rigid Ceiling Cable Suspension Kit</b></p> <p>Mechanical-only cable suspension kit for 1-circuit or 2-circuit trac. Attaches directly to junction box in rigid ceilings. Adjustable 48" or 144" stainless steel cable length. Includes mini-canopy, toggle bolt and cable hardware. Trac requires support every 4'.</p> 	<p><b>T-Bar Ceiling Cable Suspension/Feed Kit</b></p> <p>Cable suspension kit with adjustable 48" or 144" electrical feed cable for 1-circuit trac. Compatible with 15/16" flush T-Bar ceilings. Includes canopy, T-bar clip, mounting plate, cable hardware and flexible electrical feed cable. Trac feed connector not included (order separately). Trac requires support every 4'.</p>	<p><b>Rigid Ceiling Cable Suspension/Feed Kit</b></p> <p>Cable suspension kit with adjustable 48" or 144" electrical feed cable for 1-circuit trac. Attaches directly to junction box in rigid ceilings. Includes canopy, J-box mounting strap, cable hardware and flexible electrical feed cable. Trac feed connector not included (order separately). Trac requires support every 4'.</p>

**Note:** Cable suspension is recommended for pattern installations only, or those installations that are supplemented with additional rigid mounting points (stems, threaded rod, etc.).

### Accessories

Example: T31N BL

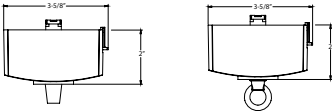
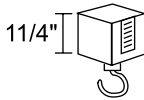
T37F	T37D	T37F916	T37D916
<p><b>15/16" T-Bar Attachment Clip</b></p> <p>To attach to inverted tee ceilings using flush tiles. Use two for 2' or 4' trac and three for 6' or 8' trac.</p> 	<p><b>15/16" T-Bar Attachment Clip</b></p> <p>Same as T37F with spacer for ceilings using drop tiles.</p>	<p><b>9/16" T-Bar Attachment Clip</b></p> <p>To attach to inverted tee ceilings using flush or drop tiles. Use two for 2' or 4' trac and three for 6' or 8' trac.</p> 	<p><b>9/16" T-Bar Attachment Clip</b></p> <p>Same as T37F916 with spacer for ceilings using drop tiles.</p>

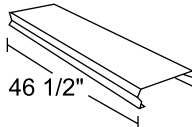
T31N	T32	T33	T39
BL, SL, WH	BL, SL, WH	BL, SL, WH	
<p><b>Pendant Adapter</b></p> <p>Adapts corded, swag or chain-hung fixture to trac. Includes loop hook for chain installation and strain relief for direct cord suspension. Chain installation accepts cord diameters up to 0.270" and supports up to 15 lbs. Strain relief installation accepts cord diameters of 0.170" to 0.255", type SVT 18/3, and supports up to 5 lbs. May also be specified with GTYPE, HTYPE or LTYPE Alternate Mounting Adapters (i.e. T31N HTYPE WH). 5A max. UL Listed.</p> 	<p><b>Plant or Utility Hook</b></p> <p>Supports up to 25 lbs. Not UL Listed.</p> 	<p><b>Outlet Adapter</b></p> <p>Provides electrical receptacle. Not UL Listed.</p> 	<p><b>Trac Wireway Cover</b></p> <p>4' black thermoplastic extrusion, covers wire carried in trac wireway. Use one for 4' trac, two for 8' and three for 12' trac. Can be field cut.</p> 

# TRAC-MASTER®

One Circuit Trac System

## TRAC SECTION, JOINERS & FEEDS T Series

### Example Trac Configurations & Recommended Components (Top Plan View)

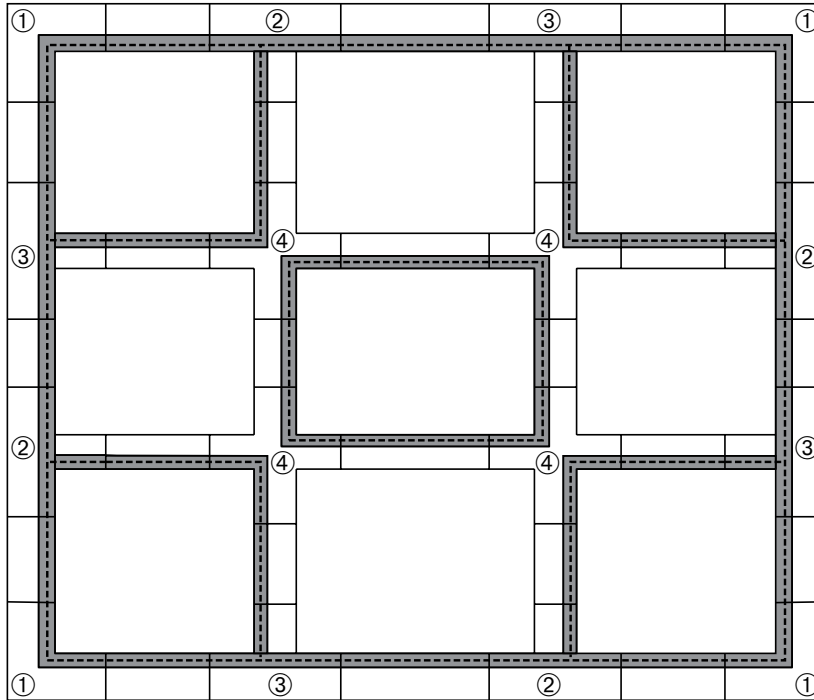
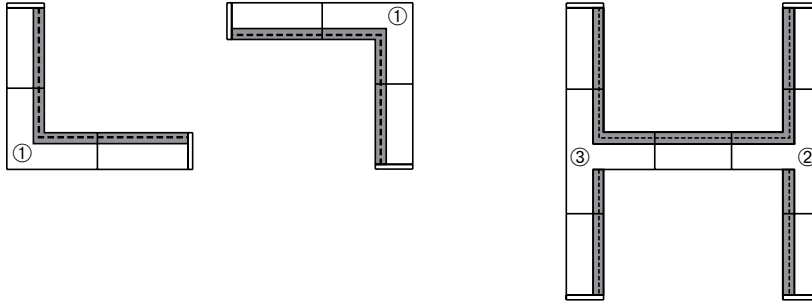

- ① Standard "L" Connector – **T24N**
- ② Standard "T" Connector – **T25**
- ③ Reverse Polarity "T" Connector – **T25 RP**
- ④ Standard "X" Connector – **T26**
- ⑤ Standard End Feed Connector – **T38** (or similar End Feed)
- ⑥ Reverse Polarity End Feed Connector – **T38 RP** (or similar Reverse Polarity End Feed)

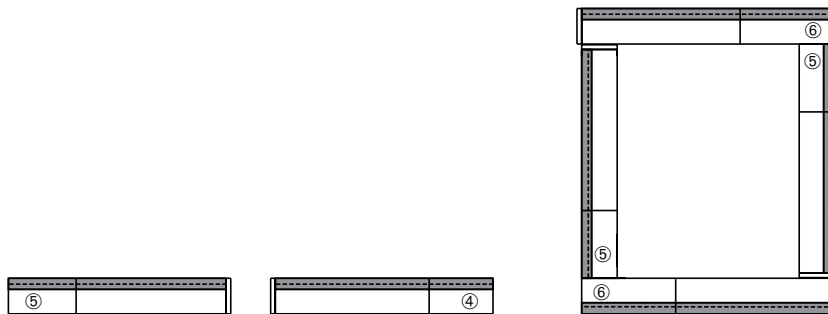

(Each run controlled by separate feeds)