



# 2" IC 600 AND 1000 LUMENS LED SQUARE ADJUSTABLE 2LEDTRIM G2 SQADJ



Project: \_\_\_\_\_

Fixture Type: \_\_\_\_\_

Location: \_\_\_\_\_

Contact/Phone: \_\_\_\_\_

## PRODUCT DESCRIPTION

2 inch aperture recessed downlight is IC rated for insulated or non-insulated applications • Luminaire produces up to 1000 lumens and is available with optical distributions approximating that of 75W MR16 halogen lamps  
 • Low profile form factor allows luminaire to fit in 2 x 6 construction  
 • Designed to provide 50,000 hours of life • 5 year limited warranty on LED Components.

## ENVIRONMENTALLY FRIENDLY, ENERGY EFFICIENT

- No harmful ultraviolet or infrared wavelengths
- No lead or mercury, RoHS compliant
- Comparable light output up to a 75W MR16 halogen lamp

## PRODUCT SPECIFICATIONS

**LED Light Engine** Exceptional fixture to fixture color consistency within a 3-step MacAdam ellipse • 2700K, 3000K, 3500K, and 4000K color temperatures are available with 80 CRI or 90 CRI minimum.

**Modular Optics** Available with field interchangeable optics in 18° Spot, 24° Narrow Flood, or 40° Flood distributions • Gimbal provides up to 35° vertical aiming and 360° horizontal aiming.

**Aesthetic Trim** Trim features die cast beveled knife edge trim ring for clean ceiling interface available in white, black, satin nickel, or brushed bronze • Die cast baffles are available in white, black, satin nickel, or brushed bronze

**LED Driver** Choice of dedicated 120 volt (120) driver or universal voltage (MVOLT) driver that accommodates input voltages from 120-277 volts AC at 50/60Hz • Power factor > 0.9 • Dedicated 120 volt driver (120) is dimmable with the use of most incandescent, magnetic low voltage and electronic low voltage dimmers • Universal voltage driver (MVOLT) is dimmable with the use of most 0-10V protocol dimmers • For a list of compatible dimmers, see [JUNO2ING2-DIM](#).

**Life** Rated for 50,000 hours at 70% lumen maintenance.

**Labels** ENERGY STAR® Certified • 90CRI fixtures are certified to the high efficacy requirements of California T24 JA8-2016 • Meets energy code Air Leakage requirements per ASTM E283 • UL and cUL listed for damp locations • 2NCHSG option is compatible with spray foam insulation with an R-value of 3.2 per inch or less.

**Junction Box** Includes (2) 1/2" knock-outs equipped with pryout slots  
 • Push-in electrical connectors for field connections.

**Mounting** Remodel style plaster frame installs from below the ceiling and accommodates ceiling thicknesses from 1/2" to 1" • For thicker ceilings up to 1 1/2", order 2JCTA150 • New Construction mounting frame, 2NCFM, is also available with Patented (US Patent D552,969) Real Nail 3® telescoping bar hangers to position fixture and locate wiring prior to ceiling installation • Recommend a minimum of 5.5" cavity depth to install properly • Flexible supply is recommended and non-flexible supply requires top access.

**Real Nail 3 Bar Hangers** 2NCHSG new construction housing and new construction mounting frame, 2NCFM, available with telescoping Real Nail® 3 system which permits quick placement of housing anywhere within 24" O.C. joists or suspended ceilings • Includes removable nail for repositioning of fixture in wood joist construction • Integral T-bar notch and clip for suspended ceilings • Design covered under US Patent D552,969 • 2NCHSG requires 2x8 construction

Specifications subject to change without notice.



## Trim Finishes

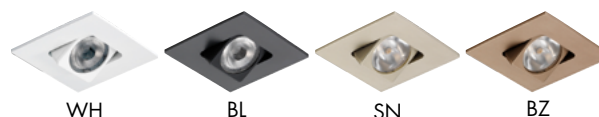

## DIMENSIONS

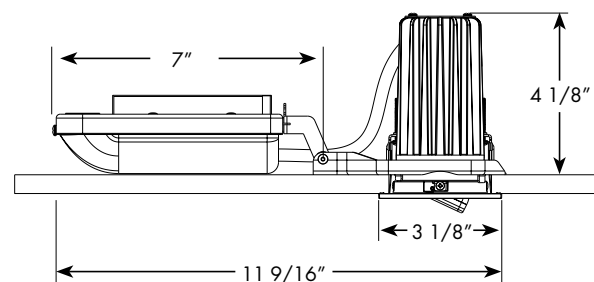

2 5/8" CIRCULAR CEILING CUTOUT

## ELECTRICAL DATA (600L)

	Dedicated 120V (120)		Universal Voltage (MVOLT)	
	Voltage	120	120	277
Input Power	7.5 (±5%)	7.2	7.5 (±5%)	
Input Current	.06	.06	.03	
Frequency	50/60Hz		50/60Hz	
Power Factor	>0.9	>0.9	>0.9	

## ELECTRICAL DATA (1000L)

	Dedicated 120V (120)		Universal Voltage (MVOLT)	
	Voltage	120	120	277
Input Power	11.5 (±5%)	10.9	11.4 (±5%)	
Input Current	.10	.09	.04	
Frequency	50/60Hz		50/60Hz	
Power Factor	>0.9	>0.9	>0.9	

# 2" IC 600 AND 1000 LUMENS LED SQUARE ADJUSTABLE 2LEDTRIM G2 SQADJ

**ORDERING INFORMATION** DRIVER AND TRIM EACH ORDERED SEPARATELY.

**DRIVER:**

Example: 2LEDDRIVER G2 06LM 120 FRPC

Series	Generation	Lumens	Voltage	Driver
2LEDDRIVER Juno Recessed 2" Driver	G2 Generation 2	06LM 600 Nominal Lumens 10LM 1000 Nominal Lumens	120 120V MVOLT Multi-Volt (120-277V)	FRPC Forward/Reverse Phase Cut ZT 0-10V Dimming

Note: 120V must be ordered with FRPC.  
MVOLT must be ordered with ZT

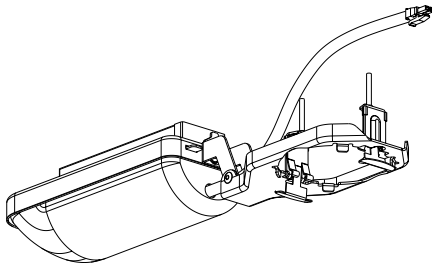

MOUNTING FRAME/DRIVER ASSEMBLY

Note: Driver assembly only intended for use with Gen2 LED trim modules. Not backward compatible with previous generation.

**TRIM:**

Example: 2LEDTRIM G2 SQADJ 27K 80CRI FL BL

Series	Generation	Trim Designation	Color Temperature	CRI	Distribution	Trim Finish
2LEDTRIM Juno Recessed 2" LED Trim	G2 Generation 2	SQADJ Square Adjustable	27K 2700K 30K 3000K 35K 3500K 40K 4000K	80CRI 80+ CRI 90CRI 90+ CRI	FL Flood NFL Narrow Flood SP Spot	BL Black BZ Bronze SN Satin Nickel WH White

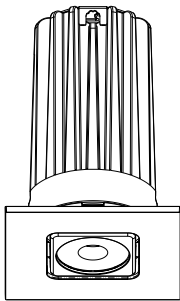

TRIM/LED ASSEMBLY

Catalog No.	Description
2NCMF	New Construction Mounting Frame with Real Nail® 3 bar hangers
2NCHSG	2" New Construction Housing for spray foam installation
2DTCA	2" LED Drop Tile Ceiling Adapter
2JCTA150	Thick Ceiling adapter for 1" - 1 1/2" thick ceiling
LEDOPTIC2 SP	18° Spot Optic
LEDOPTIC2 NFL	24° Narrow Flood Optic
LEDOPTIC2 FL	40° Flood Optic

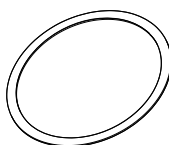
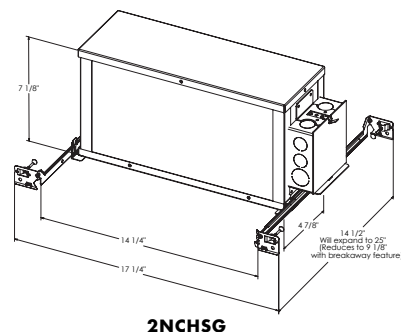
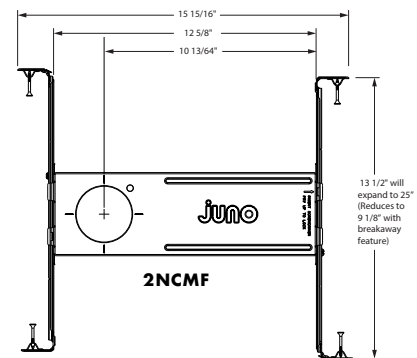

2DTCA

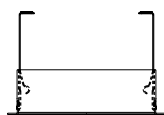

2JCTA150

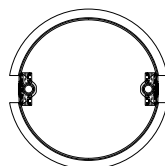

# 2" IC 600 AND 1000 LUMENS LED SQUARE ADJUSTABLE 2LEDTRIM G2 SQADJ

## PHOTOMETRICS

### PHOTOMETRIC REPORT

Test Report#: PT07162001  
 Catalog No: 2LEDTRIM G2 SQADJ 35K 80CRI  
 SP SN (600L), Square Adj Gimbal  
 with Spot Optic  
 Luminaire Spacing Criteria: 0.32  
 Luminaire LPW: 96

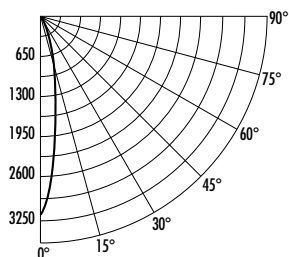

### CANDLEPOWER DISTRIBUTION (Candelas)

Degrees Vertical	0°
0	3150
5	2606
15	837
25	273
35	120
45	48
55	15
65	7
75	3
85	0
90	0

### AVERAGE INITIAL FOOTCANDLES

Multiple Units (Square Array, 60'x60' room)  
 Reflectances: Ceiling 80%, Wall 50%, Floor 20%

Spacing	RCR1	RCR3	RCR5
4'	50	44	40
5'	32	28	26
6'	22	20	18
7'	18	16	15
8'	14	13	11
9'	11	10	9
10'	8	7	6

### INITIAL FOOTCANDLES

(One Unit, 7.5W, 18.4° Beam)

Distance to Illuminated Plane (Feet)	Footcandles Beam Center	Beam Diameter
4'	196.9	1.3
6'	87.5	1.9
8'	49.2	2.6
10'	31.5	3.2
12'	21.9	3.9

### LUMINANCE (Average cd/m²)

Degrees	Average Luminance
45°	93333
55°	35330
65°	22031
75°	15871
85°	3142

### PHOTOMETRIC REPORT

Test Report#: PT07162002  
 Catalog No: 2LEDTRIM G2 SQADJ 35K 80CRI  
 NFL SN (600L), Square Adj Gimbal  
 with Narrow Flood Optic  
 Luminaire Spacing Criteria: 0.42  
 Luminaire LPW: 92

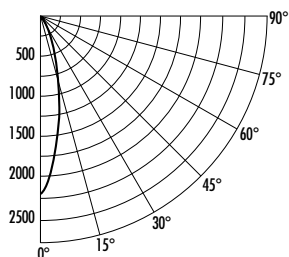

### CANDLEPOWER DISTRIBUTION (Candelas)

Degrees Vertical	0°
0	2261
5	1986
15	828
25	297
35	121
45	48
55	18
65	8
75	4
85	0
90	0

### AVERAGE INITIAL FOOTCANDLES

Multiple Units (Square Array, 60'x60' room)  
 Reflectances: Ceiling 80%, Wall 50%, Floor 20%

Spacing	RCR1	RCR3	RCR5
4'	48	43	38
5'	31	27	24
6'	21	19	17
7'	17	15	14
8'	14	12	11
9'	10	9	8
10'	8	7	6

### INITIAL FOOTCANDLES

(One Unit, 7.5W, 24.3° Beam)

Distance to Illuminated Plane (Feet)	Footcandles Beam Center	Beam Diameter
4'	141.3	1.7
6'	62.8	2.6
8'	35.3	3.4
10'	22.6	4.3
12'	15.7	5.2

### LUMINANCE (Average cd/m²)

Degrees	Average Luminance
45°	92752
55°	43446
65°	26243
75°	20103
85°	4713

### PHOTOMETRIC REPORT

Test Report#: PT07162003  
 Catalog No: 2LEDTRIM G2 SQADJ 35K 80CRI  
 FL SN (600L), Square Adj Gimbal  
 with Flood Optic  
 Luminaire Spacing Criteria: 0.70  
 Luminaire LPW: 98

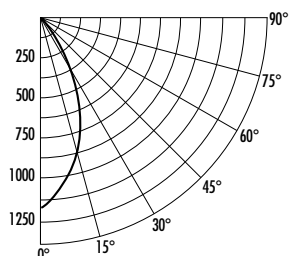

### CANDLEPOWER DISTRIBUTION (Candelas)

Degrees Vertical	0°
0	1162
5	1118
15	840
25	451
35	172
45	56
55	19
65	6
75	2
85	0
90	0

### AVERAGE INITIAL FOOTCANDLES

Multiple Units (Square Array, 60'x60' room)  
 Reflectances: Ceiling 80%, Wall 50%, Floor 20%

Spacing	RCR1	RCR3	RCR5
4'	51	45	39
5'	33	29	25
6'	23	20	17
7'	18	16	14
8'	15	13	11
9'	11	10	9
10'	8	7	6

### INITIAL FOOTCANDLES

(One Unit, 7.5W, 44.2° Beam)

Distance to Illuminated Plane (Feet)	Footcandles Beam Center	Beam Diameter
4'	72.6	3.2
6'	32.3	4.9
8'	18.2	6.5
10'	11.6	8.1
12'	8.1	9.7

### LUMINANCE (Average cd/m²)

Degrees	Average Luminance
45°	108437
55°	44163
65°	18143
75°	9522
85°	0

Fixtures tested to IES recommended standard for solid state lighting per LM-79-08. Photometric performance on a single unit represents a baseline of performance for the fixture. Results may vary in the field.

Multiplier:	80 CRI	90 CRI
	27K = .94	27K = .83
	30K = .97	30K = .86
	35K = 1.00	35K = .88
	40K = 1.03	40K = .90

# 2" IC 600 AND 1000 LUMENS LED SQUARE ADJUSTABLE 2LEDTRIM G2 SQADJ

## PHOTOMETRICS

### PHOTOMETRIC REPORT

Test Report#: PT07162004  
 Catalog No: 2LEDTRIM G2 SQADJ 35K 80CRI  
 SP SN (1000L), Square Adj Gimbal  
 with Spot Optic  
 Luminaire Spacing Criteria: 0.32  
 Luminaire LPW: 94

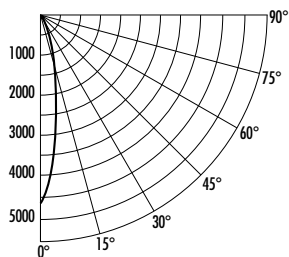

### CANDLEPOWER DISTRIBUTION (Candelas)

Degrees Vertical	0°
0	4685
5	3835
15	1232
25	406
35	179
45	72
55	22
65	10
75	5
85	1
90	0

### AVERAGE INITIAL FOOTCANDLES Multiple Units (Square Array, 60'x60' room)

Reflectances: Ceiling 80%, Wall 50%, Floor 20%

Spacing	RCR1	RCR3	RCR5
4'	74	66	60
5'	48	42	38
6'	33	29	27
7'	27	24	22
8'	21	19	17
9'	16	14	13
10'	12	11	10

### ZONAL LUMEN SUMMARY

Zone	Lumens	%Lamp	%Fixture
0-30°	857	N/A	80.6
0-40°	971	N/A	91.3
0-60°	1047	N/A	98.5
0-90°	1064	N/A	100.0

### INITIAL FOOTCANDLES

(One Unit, 11.3W, 18.2° Beam)

Distance to Illuminated Plane (Feet)	Footcandles Beam Center	Beam Diameter
4'	292.8	1.3
6'	130.1	1.9
8'	73.2	2.6
10'	46.9	3.2
12'	32.5	3.8

### LUMINANCE (Average cd/m²)

Degrees	Average Luminance
45°	139225
55°	51801
65°	33694
75°	25393
85°	10997

### PHOTOMETRIC REPORT

Test Report#: PT07162005  
 Catalog No: 2LEDTRIM G2 SQADJ 35K 80CRI  
 NFL SN (1000L), Square Adj Gimbal  
 with Narrow Flood Optic  
 Luminaire Spacing Criteria: 0.42  
 Luminaire LPW: 93

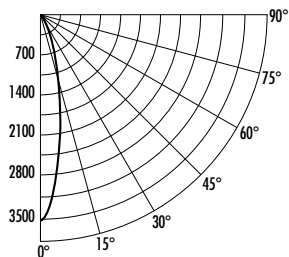

### CANDLEPOWER DISTRIBUTION (Candelas)

Degrees Vertical	0°
0	3502
5	3081
15	1287
25	454
35	182
45	71
55	27
65	13
75	6
85	1
90	0

### AVERAGE INITIAL FOOTCANDLES Multiple Units (Square Array, 60'x60' room)

Reflectances: Ceiling 80%, Wall 50%, Floor 20%

Spacing	RCR1	RCR3	RCR5
4'	73	64	58
5'	47	41	37
6'	32	29	26
7'	26	23	21
8'	21	18	16
9'	16	14	13
10'	12	10	9

### ZONAL LUMEN SUMMARY

Zone	Lumens	%Lamp	%Fixture
0-30°	834	N/A	79.4
0-40°	950	N/A	90.4
0-60°	1030	N/A	98.1
0-90°	1051	N/A	100.0

### INITIAL FOOTCANDLES

(One Unit, 11.3W, 24.1° Beam)

Distance to Illuminated Plane (Feet)	Footcandles Beam Center	Beam Diameter
4'	218.9	1.7
6'	97.3	2.6
8'	54.7	3.4
10'	35.0	4.3
12'	24.3	5.1

### LUMINANCE (Average cd/m²)

Degrees	Average Luminance
45°	136514
55°	64215
65°	40822
75°	32271
85°	14139

### PHOTOMETRIC REPORT

Test Report#: PT07162006  
 Catalog No: 2LEDTRIM G2 SQADJ 35K 80CRI  
 FL SN (1000L), Square Adj Gimbal  
 with Flood Optic  
 Luminaire Spacing Criteria: 0.70  
 Luminaire LPW: 97

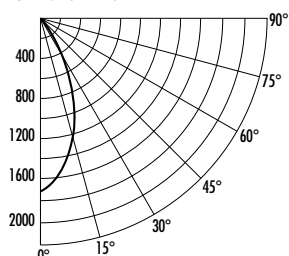

### CANDLEPOWER DISTRIBUTION (Candelas)

Degrees Vertical	0°
0	1738
5	1672
15	1257
25	677
35	259
45	84
55	28
65	9
75	3
85	0
90	0

### AVERAGE INITIAL FOOTCANDLES Multiple Units (Square Array, 60'x60' room)

Reflectances: Ceiling 80%, Wall 50%, Floor 20%

Spacing	RCR1	RCR3	RCR5
4'	76	67	58
5'	49	43	37
6'	34	30	26
7'	27	24	21
8'	22	19	17
9'	17	15	13
10'	12	11	9

### ZONAL LUMEN SUMMARY

Zone	Lumens	%Lamp	%Fixture
0-30°	823	N/A	74.7
0-40°	992	N/A	90.1
0-60°	1088	N/A	98.8
0-90°	1101	N/A	100.0

### INITIAL FOOTCANDLES

(One Unit, 11.3W, 44.2° Beam)

Distance to Illuminated Plane (Feet)	Footcandles Beam Center	Beam Diameter
4'	108.6	3.2
6'	48.3	4.9
8'	27.2	6.5
10'	17.4	8.1
12'	12.1	9.7

### LUMINANCE (Average cd/m²)

Degrees	Average Luminance
45°	162849
55°	66841
65°	28835
75°	16929
85°	1571

Fixtures tested to IES recommended standard for solid state lighting per LM-79-08. Photometric performance on a single unit represents a baseline of performance for the fixture. Results may vary in the field.

Multiplier:	80 CRI	90 CRI
	27K = .94	27K = .83
	30K = .97	30K = .86
	35K = 1.00	35K = .88
	40K = 1.03	40K = .90

# 2" IC 600 AND 1000 LUMENS LED SQUARE ADJUSTABLE 2LEDTRIM G2 SQADJ

**PHOTOMETRICS**

- CBCP** • Centerbeam candlepower
- FC** • Footcandles at beam center (aim point)

In vertical aiming applications, aim point (X) is determined by dividing distance from the wall (D) by the tangent of the desired aim angle (A) (0.5774 for 30°).

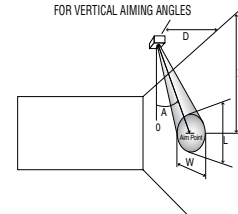
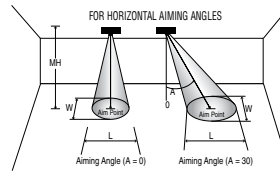

Fixture	Beam Spread	CBCP	0°				30°			30°				
			MH	FC	L	W	FC	L	W	D	FC	X	L	W
2LEDTRIM (600L) Flood Optic	40°	1162	3	129	2.2	2.2	84	3.0	2.5	1	145	1.7	4.8	1.5
			4	73	2.9	2.9	47	4.1	3.4	2	36	3.5	9.7	2.9
			5	46	3.6	3.6	30	5.1	4.2	3	16	5.2	14.5	4.4
			6	32	4.4	4.4	21	6.1	5.0	4	9	6.9	19.3	5.8
			7	24	5.1	5.1	15	7.1	5.9	5	6	8.7	24.2	7.3
2LEDTRIM (600L) Narrow Flood Optic	24°	2261	3	251	1.3	1.3	163	1.7	1.5	1	283	1.7	2.0	0.9
			4	141	1.7	1.7	92	2.3	2.0	2	71	3.5	3.9	1.7
			5	90	2.1	2.1	59	2.9	2.5	3	31	5.2	5.9	2.6
			6	63	2.6	2.6	41	3.5	2.9	4	18	6.9	7.9	3.4
			7	46	3.0	3.0	30	4.0	3.4	5	11	8.7	9.8	4.3
2LEDTRIM (600L) Spot Optic	18°	3150	4	197	1.3	1.3	128	1.7	1.5	2	98	3.5	2.7	1.3
			5	126	1.6	1.6	82	2.1	1.8	3	44	5.2	4.1	1.9
			6	88	1.9	1.9	57	2.6	2.2	4	25	6.9	5.5	2.5
			7	64	2.2	2.2	42	3.0	2.6	5	16	8.7	6.9	3.2
			8	49	2.5	2.5	32	3.4	2.9	6	11	10.4	8.2	3.8

For 2700K fixtures, use 0.96 multiplier; for 3000K fixtures, use 1.00 multiplier;  
for 3500K fixtures, use 1.03 multiplier; for 4000K fixtures, use 1.06 multiplier.

Fixture	Beam Spread	CBCP	0°				30°			30°				
			MH	FC	L	W	FC	L	W	D	FC	X	L	W
2LEDTRIM (1000L) Flood Optic	40°	1738	3	193	2.2	2.2	125	3.0	2.5	1	217	1.7	4.8	1.5
			4	109	2.9	2.9	71	4.1	3.4	2	54	3.5	9.7	2.9
			5	70	3.6	3.6	45	5.1	4.2	3	24	5.2	14.5	4.4
			6	48	4.4	4.4	31	6.1	5.0	4	14	6.9	19.3	5.8
			7	35	5.1	5.1	23	7.1	5.9	5	9	8.7	24.2	7.3
2LEDTRIM (1000L) Narrow Flood Optic	24°	3502	3	389	1.3	1.3	253	1.7	1.5	1	438	1.7	2.0	0.9
			4	219	1.7	1.7	142	2.3	2.0	2	109	3.5	3.9	1.7
			5	140	2.1	2.1	91	2.9	2.5	3	49	5.2	5.9	2.6
			6	97	2.6	2.6	63	3.5	2.9	4	27	6.9	7.9	3.4
			7	71	3.0	3.0	46	4.0	3.4	5	18	8.7	9.8	4.3
2LEDTRIM (1000L) Spot Optic	18°	4685	4	293	1.3	1.3	190	1.7	1.5	2	146	3.5	2.7	1.3
			5	187	1.6	1.6	122	2.1	1.8	3	65	5.2	4.1	1.9
			6	130	1.9	1.9	85	2.6	2.2	4	37	6.9	5.5	2.5
			7	96	2.2	2.2	62	3.0	2.6	5	23	8.7	6.9	3.2
			8	73	2.5	2.5	48	3.4	2.9	6	16	10.4	8.2	3.8

For 2700K fixtures, use 0.96 multiplier; for 3000K fixtures, use 1.00 multiplier;  
for 3500K fixtures, use 1.03 multiplier; for 4000K fixtures, use 1.06 multiplier.