

The Premium Choice in Landscape Lighting



style to live by™

KICHLER.



A beautiful landscape... starts with a landscape lighting professional.

From the latest LED systems to traditional incandescent choices, the complete Kichler® landscape collection helps landscape lighting pros create amazing outdoor living spaces. Leading the way is our Design Pro LED fixtures with Radiax™ optics. These fixtures generate more lumens with less wattage for superior lighting effects, all with the proven performance of Kichler Design Pro LED. They are part of our growing Design Pro LED line featuring fixtures for virtually every outdoor lighting application — including decorative path and spread, low profile hardscape, water feature, deck, patio and accent lighting. And, they're just one more way Kichler supports the landscape lighting professional, with durable, innovative and time-tested technologies engineered for optimum all-weather performance.

Start with your ideas and let Kichler bring them to light.



Become a fan of Kichler Lighting at:
[facebook.com search Kichler Lighting](https://www.facebook.com/search/Kichler+Lighting)



Follow us on
twitter.com/kichlerlight



Watch us on
[youtube.com/KichlerLighting](https://www.youtube.com/KichlerLighting)

Table of Contents





20



64



159



69

LED 12V, 24V & 120V

- Design Pro LED 12V Path & Spread.....8
- Design Pro LED 12V Deck & Patio..... 22
- Design Pro LED 12V Hardscape, Deck, Step & Bench..... 28
- TaskWork LED 24V DC Outdoor Wet Tape Light..... 36
- Design Pro LED with Radiax™ Optics 12V Accent..... 44
- Design Pro LED with Radiax Optics 120V Accent.....50,166
- Design Pro LED 12V Accent.....58
- Design Pro LED 12V Wall Wash Accent..... 60
- Design Pro LED with Radiax Optics 12V In-Ground.....62
- Design Pro LED 12V In-Ground.....66
- Design Pro LED 12V 2-in-1 Water/Accent Light 68



25



45



192

Incandescent / LED 12V

- Hybrid Path & Spread.....72
- Hybrid Speciality..... 100
- Hybrid Deck & Patio..... 104
- Hybrid Accent..... 116
- Hybrid In-Ground..... 130
- Hybrid Water Feature Lighting.....134
- 12V Transformers.....136
- Accessories..... 146
- LED 12V Lamps..... 154
- Incandescent 12V Lamps..... 160



140



105

Incandescent / LED 120V / HID

- Design Pro LED with Radiax Optics 120V Accent..... 166
- Hybrid Accent..... 170
- Path & Spread..... 178
- Outdoor..... 182
- Incandescent HID Ballasts..... 184
- Accessories..... 186
- LED 120V Lamps..... 190
- Lamps & Photometrics..... 194



78



52

Index

- Fixture Photometrics..... 198
- Pictorial Index..... 204
- Numerical Index..... 210
- Ceiling Fans..... 212
- Outdoor..... 214



35



172



What “Powered by Design Pro LED Technology” means to you:

Professional-grade LED lighting and system components, designed and engineered for optimum all-weather performance with natural lighting effects, deliver professional results.

With Kichler® Design Pro LED technology, now available with our Radiax™ optics, you get extremely efficient, state-of-the-art fixtures that deliver light with a range of Kelvin temperatures and the right amount of lumens to enhance any exterior design – and illuminate a specific application the way it was intended.

Plus, Kichler Design Pro LED gives homeowners long-term cost savings since the fixtures use 80% less electricity than traditional lighting.

The complete Kichler Landscape Lighting collection features an extensive selection of Design Pro LED fixtures that enhance any landscape lighting job.

LED Energy & Cost Comparison

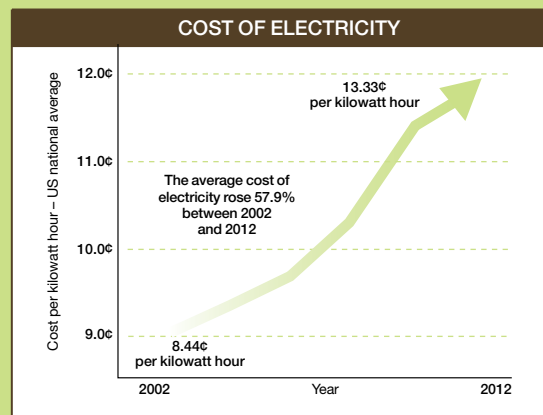
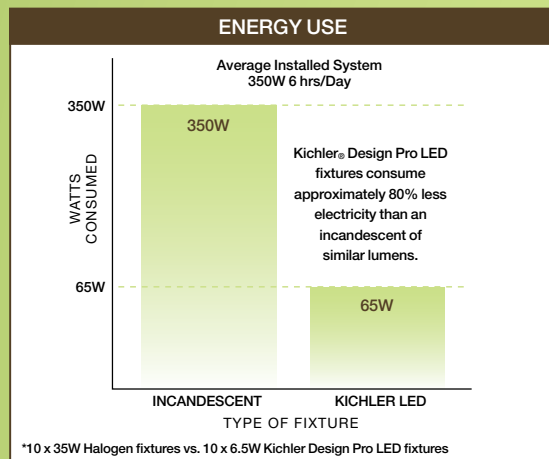

Design Pro LED 12V Path & Spread

Meet the new standard for path and spread applications.





15857 AZT - LED PIERCED DOME **15807 AZT, BBR - LED SHEPHERD'S CROOK** **15801 TZT - LED TIKI**

Description	A cast dome sculpted with a floral band and pierced to reveal a sophisticated pattern of LED light.	Traditional flare with today's LED technology.	A warm, soft center glow adds just the right hint of detail to this center mount LED path and spread.
Ordering Guide & Finish	15857 AZT - Textured Architectural Bronze (Marine grade powder coat)	15807 AZT - Textured Architectural Bronze (Marine grade powder coat) 15807 BBR - Bronzed Brass	15801 TZT - Textured Tannery Bronze™ (Marine grade powder coat)
Housing	Cast Aluminum	Cast Aluminum, Brass	Cast Aluminum
Light Source	3 Integrated High Output Nichia® LEDs, tightly binned for color uniformity, and constant current driver	3 Integrated High Output Nichia® LEDs, tightly binned for color uniformity, and constant current driver	3 Integrated High Output Nichia® LEDs, tightly binned for color uniformity, and constant current driver
Color Temp. (CCT) & CRI	3000K (-200/+125) / 80s CRI	3000K (-200/+125) / 80s CRI	3000K (-200/+125) / 80s CRI
Power Usage at 12V AC Input VA and Watts	4 W, 5.8 VA Multiply fixture VA by the number of fixtures used to determine size of transformer	High - 4 W, 5.8 VA Low - 2.5 W, 4 VA Multiply fixture VA by the number of fixtures used to determine size of transformer	4 W, 5.8 VA Multiply fixture VA by the number of fixtures used to determine size of transformer
Operating Voltage Range	9V-15V AC/DC with no loss in output due to constant current technology	9V-15V AC/DC with no loss in output due to constant current technology	9V-15V AC/DC with no loss in output due to constant current technology
Lumen Maint.	Tested to an L-70 of 40,000 hours	Tested to an L-70 of 40,000 hours	Tested to an L-70 of 40,000 hours
Total Lumens & Efficacy	3000K = 140 Lm 3000K = 35 Lm/W	3000K = 140 Lm (High), 80 Lm (Low) 3000K = 35 Lm/W (High), 20 Lm/W (Low)	3000K = 140 Lm 3000K = 35 Lm/W
Wiring	30" of useable #18-2, SPT-1W leads. Cable connector supplied	24" of useable #18-2, SPT-1W leads. Cable connector supplied	24" of useable #18-2, SPT-1W leads. Cable connector supplied
Mounting Acces. Included	8" in-ground stake	8" In-ground stake	8" In-ground stake
Optional Acces.	15601 - Surface Mounting Flange 15607 - Surface Mounting Bracket	15601 - Surface Mounting Flange 15607 - Surface Mounting Bracket	15601 - Surface Mounting Flange 15607 - Surface Mounting Bracket
Incandescent	15457 - on page 78	NA	NA
Notes	Subjected to Highly Accelerated Life Testing - 3rd party reliability testing. Not for use with electronic transformers	Subjected to Highly Accelerated Life Testing - 3rd party reliability testing. Not for use with electronic transformers	Subjected to Highly Accelerated Life Testing - 3rd party reliability testing. Not for use with electronic transformers
Fixture Photometric (fc)	Distance from Light 0' 1' 2' 3' 4' 5' 6' 7' 8' Footcandles 4.55 4.08 3.23 2.26 1.57 0.47 0.41 0.29 0.25	Distance from Light 0' 1' 2' 3' 4' 5' 6' 7' 8' Footcandles 19.9 10.7 3.56 1.45 0.57 0.26 0.14 0.08 -	Distance from Light 0' 1' 2' 3' 4' 5' 6' 7' 8' Footcandles 6.22 3.8 2.8 1.41 0.76 0.43 0.3 0.19 0.12

DESIGN PRO LED 12V PATH & SPREAD

D

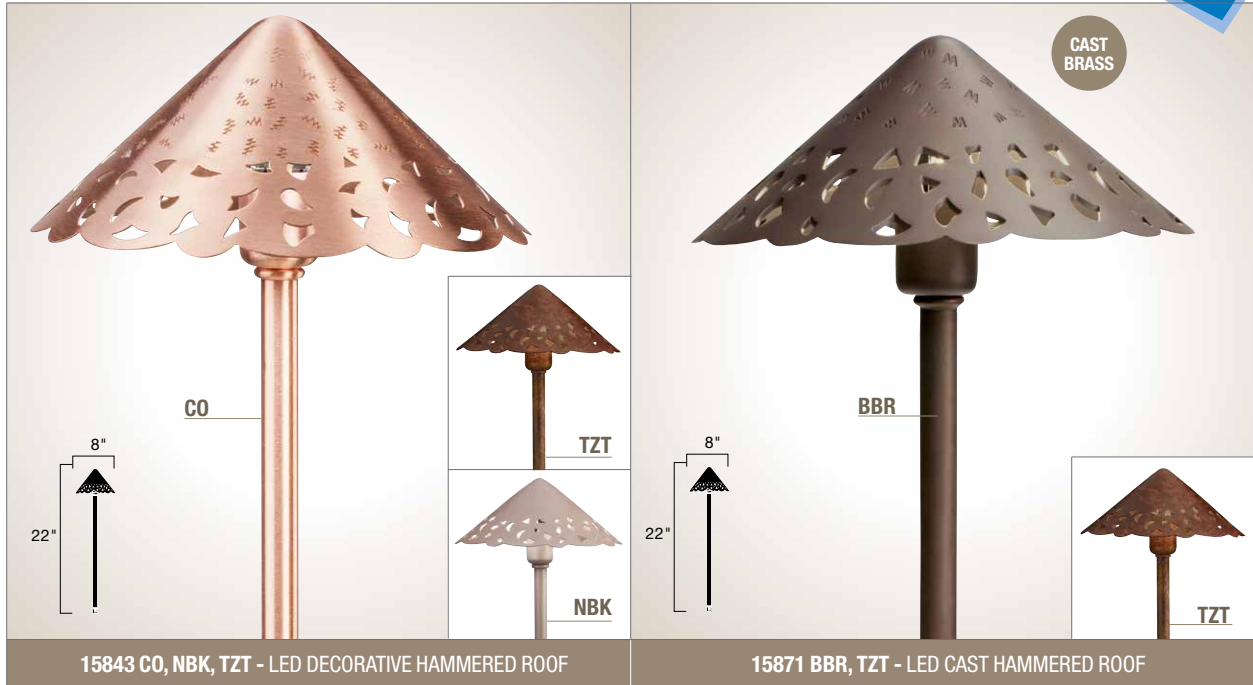

	15843 CO, NBK, TZT - LED DECORATIVE HAMMERED ROOF	15871 BBR, TZT - LED CAST HAMMERED ROOF
Description	Pierced shade sheds decorative patterned light with the added benefit of LED technology. Coordinates with matching LED deck light 15763 on page 23.	Pierced shade sheds decorative patterned LED light over shrubs, gardens, or walkways. Coordinates with matching LED deck light 15763 on page 23.
Ordering Guide & Finish	15843 CO - Unfinished Copper (Marine grade powder coat) 15843 NBK - New Brick™ (Marine grade powder coat) 15843 TZT - Textured Tannery Bronze™ (Marine grade powder coat)	15871 BBR - Bronzed Brass (Marine grade powder coat) 15871 TZT - Textured Tannery Bronze™ (Marine grade powder coat)
Housing	Brass or Copper (copper will naturally patina over time)	Cast Aluminum, Cast Brass
Light Source	3 Integrated High Output Nichia® LEDs, tightly binned for color uniformity, and constant current driver	3 Integrated High Output Nichia® LEDs, tightly binned for color uniformity, and constant current driver
Color Temp. (CCT) & CRI	3000K (-200/+125) / 80s CRI	3000K (-200/+125) / 80s CRI
Power Usage at 12V AC Input VA and Watts	4 W, 5.8 VA, Multiply fixture VA by the number of fixtures used to determine size of transformer	4 W, 5.8 VA Multiply fixture VA by the number of fixtures used to determine size of transformer
Operating Voltage Range	9V-15V AC/DC with no loss in output due to constant current technology	9V-15V AC/DC with no loss in output due to constant current technology
Lumen Maint.	Tested to an L-70 of 40,000 hours	Tested to an L-70 of 40,000 hours
Total Lumens & Efficacy	3000K = 187 Lm 3000K= 47 Lm/W	3000K = 187 Lm 3000K= 47 Lm/W
Wiring	30" of usable #18-2, SPT-1-W leads. Cable connector supplied	30" of useable #18-2, SPT-1W leads. Cable connector supplied
Mounting Acces. Included	8" in-ground stake	8" In-ground stake
Optional Acces.	15601 - Surface Mounting Flange 15607 - Surface Mounting Bracket	15601 - Surface Mounting Flange 15607 - Surface Mounting Bracket
Incandescent	15443 - on page 80	15471 - on page 81
Notes	Subjected to Highly Accelerated Life Testing - 3rd party reliability testing Not for use with electronic transformers	Subjected to Highly Accelerated Life Testing - 3rd party reliability testing Not for use with electronic transformers
Fixture Photometric (fc)	Distance from Light 0' 1' 2' 3' 4' 5' 6' 7' 8' Footcandles 10.9 5.8 2.3 1.0 0.43 0.25 0.13 0.06 0.01	Distance from Light 0' 1' 2' 3' 4' 5' 6' 7' 8' Footcandles 10.9 5.8 2.3 1.0 0.43 0.25 0.13 0.06 0.01



15839 CO, TZT - LED FUNDAMENTALS™

15850 CO - LED COPPER HAT

Description	Basic, uncomplicated design for versatility. Use along walkways or points of interest. Heavy gauge copper makes this proven look fit in any setting.	Design Pro LED in a definitive yet unassuming copper housing. Will develop a natural verdigris over time.
Ordering Guide & Finish	15839 CO - Unfinished Copper 15839 TZT - Textured Tannery Bronz™e (Marine grade powder coat)	15850 CO - Unfinished Copper
Housing	Brass or Copper (copper will naturally patina over time)	Copper (copper will naturally patina over time)
Light Source	3 Integrated High Output Nichia® LEDs, tightly binned for color uniformity, and constant current driver	3 Integrated High Output Nichia® LEDs, tightly binned for color uniformity, and constant current driver
Color Temp. (CCT) & CRI	3000K (-200/+125) / 80s CRI	3000K (-200/+125) / 80s CRI
Power Usage at 12V AC Input VA and Watts	4 W, 5.8 VA Multiply fixture VA by the number of fixtures used to determine size of transformer	4 W, 5.8 VA Multiply fixture VA by the number of fixtures used to determine size of transformer
Operating Voltage Range	9V-15V AC/DC with no loss in output due to constant current technology	9V-15V AC/DC with no loss in output due to constant current technology
Lumen Maint.	Tested to an L-70 of 40,000 hours	Tested to an L-70 of 40,000 hours
Total Lumens & Efficacy	3000K = 140 Lm 3000K= 35 Lm/W	3000K = 140 Lm 3000K= 35 Lm/W
Wiring	55" of useable #18-2, SPT-1W leads. Cable connector supplied	30" of useable #18-2, SPT-1W leads. Cable connector supplied
Mounting Acces. Included	8" in-ground stake	8" In-ground stake
Optional Acces.	15601 - Surface Mounting Flange 15607 - Surface Mounting Bracket	15601 - Surface Mounting Flange 15607 - Surface Mounting Bracket
Incandescent	15439 - on page 94	15350 - on page 83
Notes	Subjected to Highly Accelerated Life Testing - 3rd party reliability testing Not for use with electronic transformers	Subjected to Highly Accelerated Life Testing - 3rd party reliability testing Not for use with electronic transformers
Fixture Photometric (fc)	Distance from Light 0' 1' 2' 3' 4' 5' 6' 7' 8' Footcandles 10.77 6.12 3.87 2.57 1.99 1.77 1.12 0.87 0.61	Distance from Light 0' 1' 2' 3' 4' 5' 6' 7' 8' Footcandles 8.77 6.57 4.37 2.77 1.77 1.57 0.61 0.41 0.28

DESIGN PRO LED 12V PATH & SPREAD

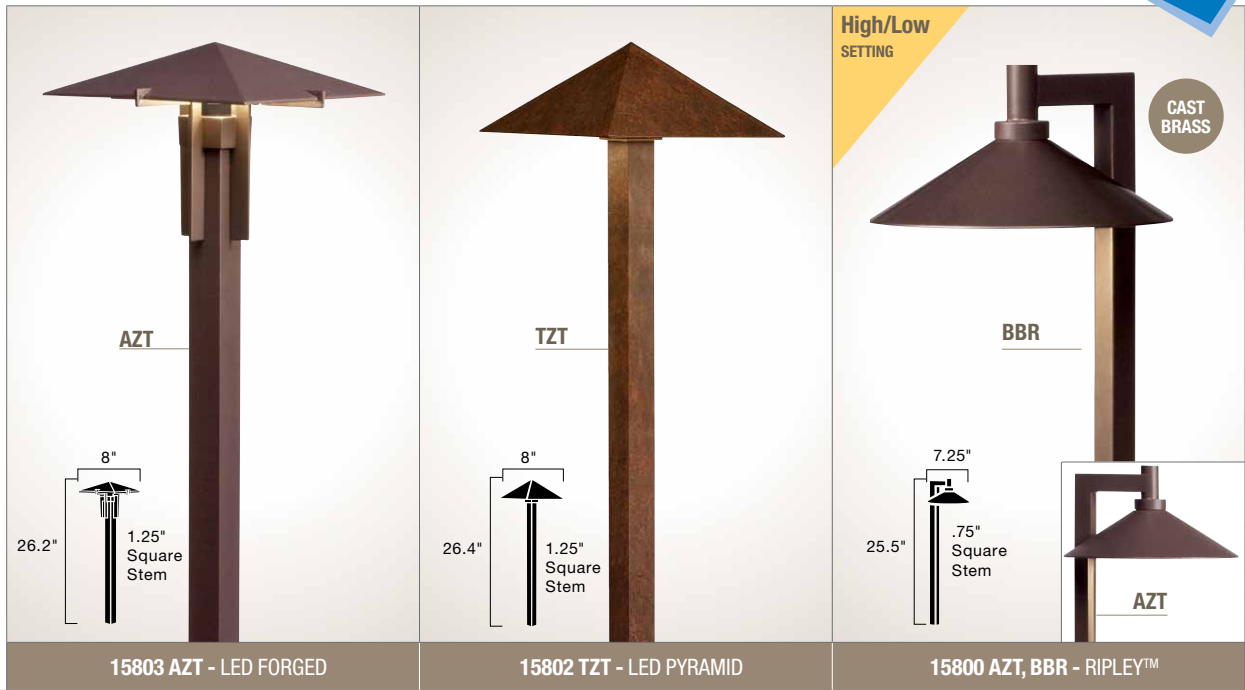

15803 AZT - LED FORGED **15802 TZT - LED PYRAMID** **15800 AZT, BBR - RIPLEY™**

Description	A mission style offering in Design Pro LED. A substantial design supported by thick cast construction.	A style to fit a wide variety of tastes, the subtle look of this design will find a home in a wide variety of landscapes.	Inspired by the popular Kichler® Ripley™ outdoor lantern, the rich tones, clean lines and sturdy construction make this path light a welcome addition to any transitional outdoor lighting design.
Ordering Guide & Finish	15803 AZT - Textured Architectural Bronze (Marine grade powder coat)	15802 TZT - Textured Tannery Bronze (Marine grade powder coat)	15800 AZT - Textured Architectural Bronze (Marine grade powder coat) 15800 BBR - Bronzed Brass
Housing	Cast Aluminum	Cast Aluminum	Cast Aluminum, Cast Brass
Light Source	3 Integrated High Output Nichia® LEDs, tightly binned for color uniformity, and constant current driver	3 Integrated High Output Nichia® LEDs, tightly binned for color uniformity, and constant current driver	3 Integrated High Output Nichia® LEDs, tightly binned for color uniformity, and constant current driver
Color Temp. (CCT) & CRI	3000K (-200/+125) / 80s CRI	3000K (-200/+125) / 80s CRI	3000K (-200/+125) / 80s CRI
Power Usage at 12V AC Input VA and Watts	4 W, 5.8 VA Multiply fixture VA by the number of fixtures used to determine size of transformer	High - 4 W, 5.8 VA Low - 2.5 W, 4 VA Multiply fixture VA by the number of fixtures used to determine size of transformer	High - 4 W, 5.8 VA Low - 2.5W, 4 VA Multiply fixture VA by the number of fixtures used to determine size of transformer
Operating Voltage Range	9V-15V AC/DC with no loss in output due to constant current technology	9V-15V AC/DC with no loss in output due to constant current technology	9V-15V AC/DC with no loss in output due to constant current technology
Lumen Maint.	Tested to an L-70 of 40,000 hours	Tested to an L-70 of 40,000 hours	Tested to an L-70 of 40,000 hours
Total Lumens & Efficacy	3000K = 140 Lm 3000K = 35 Lm/W	3000K = 140 Lm 3000K = 35 Lm/W	3000K = 140 Lm (High), 80 Lm (Low) 3000K = 35 Lm/W (High), 20 Lm/W (Low)
Wiring	24" of useable #18-2, SPT-1W leads Cable connector supplied	30" of useable #18-2, SPT-1W leads Cable connector supplied	24" of useable #18-2, SPT-1W leads Cable connector supplied
Mounting Acces. Included	8" in-ground stake	8" In-ground stake	8" In-ground stake
Optional Acces.	15601 - Surface Mounting Flange 15607 - Surface Mounting Bracket	15601 - Surface Mounting Flange 15607 - Surface Mounting Bracket	15601 - Surface Mounting Flange 15607 - Surface Mounting Bracket
Notes	Subjected to Highly Accelerated Life Testing - 3rd party reliability testing. Not for use with electronic transformers	Subjected to Highly Accelerated Life Testing - 3rd party reliability testing. Not for use with electronic transformers	Subjected to Highly Accelerated Life Testing - 3rd party reliability testing. Not for use with electronic transformers
Fixture Photometric (fc)	Distance from Light 0' 1' 2' 3' 4' 5' 6' 7' 8' Footcandles 4.23 2.35 1.50 0.83 0.51 0.35 0.22 0.17 0.10	Distance from Light 0' 1' 2' 3' 4' 5' 6' 7' 8' Footcandles 8.01 5.4 2.23 .85 .37 .19 0.09 - -	Distance from Light 0' 1' 2' 3' 4' 5' 6' 7' 8' Footcandles 23.5 11.9 4.54 1.63 0.71 0.32 0.18 0.12 -



	15833 AZT - LED BROAD ROOF	15804 AZT - LED TAPERED COLUMN																																								
Description	A sculpted spindle center is capped by a broad, shallow roof that diffuses and spreads LED light.	A tapered column rises to a narrow point and then widens to expose LED illumination emanating from the reverse taper cap.																																								
Ordering Guide & Finish	15833 AZT - Textured Architectural Bronze (Marine grade powder coat)	15804 AZT - Textured Architectural Bronze (Marine grade powder coat)																																								
Housing	Cast Aluminum	Cast Aluminum																																								
Light Source	3 Integrated High Output Nichia® LEDs, tightly binned for color uniformity, and constant current driver	3 Integrated High Output Nichia® LEDs, tightly binned for color uniformity, and constant current driver																																								
Color Temp. (CCT) & CRI	3000K (-200/+125) / 80s CRI	3000K (-200/+125) / 80s CRI																																								
Power Usage at 12V AC Input VA and Watts	4 W, 5.8 VA Multiply fixture VA by the number of fixtures used to determine size of transformer	1 W, 1.7 VA Multiply fixture VA by the number of fixtures used to determine size of transformer																																								
Operating Voltage Range	9V-15V AC/DC with no loss in output due to constant current technology	9V-15V AC/DC with no loss in output due to constant current technology																																								
Lumen Maint.	Tested to an L-70 of 40,000 hours	Tested to an L-70 of 40,000 hours																																								
Total Lumens & Efficacy	3000K = 140 Lm 3000K = 35 Lm/W	3000K = 140 Lm 3000K = 35 Lm/W																																								
Wiring	30" of usable #18-2, SPT-1-W leads. Cable connector supplied	30" of usable #18-2, SPT-1-W leads. Cable connector supplied																																								
Mounting Acces Included	8" in-ground stake	8" in-ground stake																																								
Optional Acces.	15601 - Surface Mounting Flange 15607 - Surface Mounting Bracket	15601 - Surface Mounting Flange 15607 - Surface Mounting Bracket																																								
Notes	Subjected to Highly Accelerated Life Testing - 3rd party reliability testing Not for use with electronic transformers	Subjected to Highly Accelerated Life Testing - 3rd party reliability testing Not for use with electronic transformers																																								
Fixture Photometric (fc)	<table border="1"> <tr> <td>Distance from Light</td> <td>0'</td><td>1'</td><td>2'</td><td>3'</td><td>4'</td><td>5'</td><td>6'</td><td>7'</td><td>8'</td> </tr> <tr> <td>Footcandles</td> <td>13.5</td><td>3.7</td><td>0.8</td><td>0.3</td><td>0.2</td><td>0.1</td><td>-</td><td>-</td><td>-</td> </tr> </table>	Distance from Light	0'	1'	2'	3'	4'	5'	6'	7'	8'	Footcandles	13.5	3.7	0.8	0.3	0.2	0.1	-	-	-	<table border="1"> <tr> <td>Distance from Light</td> <td>0'</td><td>1'</td><td>2'</td><td>3'</td><td>4'</td><td>5'</td><td>6'</td><td>7'</td><td>8'</td> </tr> <tr> <td>Footcandles</td> <td>7.2</td><td>3.5</td><td>1.4</td><td>0.8</td><td>0.5</td><td>0.3</td><td>-</td><td>-</td><td>-</td> </tr> </table>	Distance from Light	0'	1'	2'	3'	4'	5'	6'	7'	8'	Footcandles	7.2	3.5	1.4	0.8	0.5	0.3	-	-	-
Distance from Light	0'	1'	2'	3'	4'	5'	6'	7'	8'																																	
Footcandles	13.5	3.7	0.8	0.3	0.2	0.1	-	-	-																																	
Distance from Light	0'	1'	2'	3'	4'	5'	6'	7'	8'																																	
Footcandles	7.2	3.5	1.4	0.8	0.5	0.3	-	-	-																																	



15805 BKT - LED SHALLOW SHADE - SMALL **15806 BKT - LED SHALLOW SHADE - LARGE** **15817 AZT, BN - LED GLASS & METAL**

Description	A design only made possible by today's LED technology, this fixture will surely captivate its audience with its unobtrusive styling. Coordinates with the 15806.	A design only made possible by today's LED technology, this fixture will surely captivate its audience with its unobtrusive styling. Coordinates with the 15805.	A sleek, modern original that combines contemporary style with smooth LED illumination.
Ordering Guide & Finish	15805 BKT - Textured Black (Marine grade powder coat)	15806 BKT - Textured Black (Marine grade powder coat)	15817 AZT - Textured Architectural Bronze (Marine grade powder coat) 15817 BN - Brushed Nickel
Housing	Cast Aluminum	Cast Aluminum	Aluminum (AZT) or Brass (BN) with glass diffuser
Light Source	3 Integrated High Output Nichia® LEDs, tightly binned for color uniformity, and constant current driver	3 Integrated High Output Nichia® LEDs, tightly binned for color uniformity, and constant current driver	3 Integrated High Output Nichia® LEDs, tightly binned for color uniformity, and constant current driver
Color Temp. (CCT) & CRI	3000K (-200/+125) / 80s CRI	3000K (-200/+125) / 80s CRI	3000K (-200/+125) / 80s CRI
Power Usage at 12V AC Input VA and Watts	4 W, 5.8 VA Multiply fixture VA by the number of fixtures used to determine size of transformer	4 W, 5.8 VA Multiply fixture VA by the number of fixtures used to determine size of transformer	4 W, 5.8 VA Multiply fixture VA by the number of fixtures used to determine size of transformer
Operating Voltage Range	9V-15V AC/DC with no loss in output due to constant current technology	9V-15V AC/DC with no loss in output due to constant current technology	9V-15V AC/DC with no loss in output due to constant current technology
Lumen Maint.	Tested to an L-70 of 40,000 hours	Tested to an L-70 of 40,000 hours	Tested to an L-70 of 40,000 hours
Total Lumens & Efficacy	3000K = 140 Lm 3000K = 35 Lm/W	3000K = 140 Lm 3000K = 35 Lm/W	3000K = 140 Lm 3000K = 35 Lm/W
Wiring	30" of useable #18-2, SPT-1W leads Cable connector supplied	30" of useable #18-2, SPT-1W leads Cable connector supplied	30" of useable #18-2, SPT-1W leads Cable connector supplied
Mounting Acces. Included	8" in-ground stake	8" In-ground stake	8" In-ground stake
Optional Acces.	15601 - Surface Mounting Flange 15607 - Surface Mounting Bracket	15601 - Surface Mounting Flange 15607 - Surface Mounting Bracket	15601 - Surface Mounting Flange 15607 - Surface Mounting Bracket
Incandescent	NA	NA	15317 - on page 92
Notes	Subjected to Highly Accelerated Life Testing - 3rd party reliability testing. Not for use with electronic transformers	Subjected to Highly Accelerated Life Testing - 3rd party reliability testing. Not for use with electronic transformers	Subjected to Highly Accelerated Life Testing - 3rd party reliability testing. Not for use with electronic transformers
Fixture Photometric (fc)	Distance from Light 0' 1' 2' 3' 4' 5' 6' 7' 8' Footcandles 21.2 12.1 5.3 1.56 .23 .33 .11 .06 -	Distance from Light 0' 1' 2' 3' 4' 5' 6' 7' 8' Footcandles 20.7 11.1 4.8 1.56 0.55 0.33 0.11 0.06 -	Distance from Light 0' 1' 2' 3' 4' 5' 6' 7' 8' Footcandles 5.47 6.07 3.87 2.12 1.17 0.77 0.38 0.16 0.04



15815 AZT, BE, BKT - LED SIDE MOUNT

15827 BBR - LED SIDE MOUNT CAST BRASS

Description	LED technology is combined with a side mount design for more directional lighting, without glare. Coordinates with matching LED deck light 15765 on page 24.	LED technology is combined with premium solid brass material, engineered to withstand harsh coastal conditions. Coordinates with matching LED deck light 15765 on page 24.
Ordering Guide & Finish	15815 AZT - Textured Architectural Bronze (Marine grade powder coat) 15815 BE - Beach (Marine grade powder coat) 15815 BKT - Textured Black (Marine grade powder coat)	15827 BBR - Bronzed Brass
Housing	Cast Aluminum	Cast Brass
Light Source	3 Integrated High Output Nichia® LEDs, tightly binned for color uniformity, and constant current driver	3 Integrated High Output Nichia® LEDs, tightly binned for color uniformity, and constant current driver
Color Temp. (CCT) & CRI	3000K (-200/+125) / 80s CRI	3000K (-200/+125) / 80s CRI
Power Usage at 12V AC Input VA and Watts	4 W, 5.8 VA Multiply fixture VA by the number of fixtures used to determine size of transformer	High 4 W, 5.8 VA Low 2.5 W, 4 VA Multiply fixture VA by the number of fixtures used to determine size of transformer
Operating Voltage Range	9V-15V AC/DC with no loss in output due to constant current technology	9V-15V AC/DC with no loss in output due to constant current technology
Lumen Maint.	Tested to an L-70 of 40,000 hours	Tested to an L-70 of 40,000 hours
Total Lumens & Efficacy	3000K = 140 Lm/W (High) 3000K = 80 Lm/W (Low) 3000K = 35 Lm/W (High) 3000K = 20 Lm/W (Low)	3000K = 140 Lm/W (High) 3000K = 80 Lm/W (Low) 3000K = 35 Lm/W (High) 3000K = 20 Lm/W (Low)
Wiring	53" of usable #18-2, SPT-1-W leads. Cable connector supplied	53" of usable #18-2, SPT-1-W leads. Cable connector supplied
Mounting Acces. Included	8" in-ground stake	8" in-ground stake
Optional Acces.	15601 - Surface Mounting Flange 15607 - Surface Mounting Bracket	15601 - Surface Mounting Flange 15607 - Surface Mounting Bracket
Opt. Lens Acces.	15695 CLR - Sprinkler Sheid	15677 CLR - Sprinkler Sheid
Incandescent	15315 - on page 95	NA
Notes	Subjected to Highly Accelerated Life Testing - 3rd party reliability testing Not for use with electronic transformers	Subjected to Highly Accelerated Life Testing - 3rd party reliability testing Not for use with electronic transformers
Fixture (High) Photometric (fc)	Distance from Light 0' 1' 2' 3' 4' 5' 6' 7' 8' Footcandles 31.5 172 6.7 2.5 1.2 0.5 - - -	Distance from Light 0' 1' 2' 3' 4' 5' 6' 7' 8' Footcandles 31.5 172 6.7 2.5 1.2 0.5 - - -
Fixture (Low) Photometric (fc)	Distance from Light 0' 1' 2' 3' 4' 5' 6' 7' 8' Footcandles 21.3 12 4.1 1.7 0.7 0.2 - - -	Distance from Light 0' 1' 2' 3' 4' 5' 6' 7' 8' Footcandles 21.3 12 4.1 1.7 0.7 0.2 - - -

DESIGN PRO LED 12V PATH & SPREAD

D



15826 AZT, BE, BKT - LED CENTER MOUNT

15870 AZT, BBR, BE, BKT - LED 6" DOME PATH LIGHT

Description	Unobtrusive, center mount fixture for maximum light spread with the added benefit of LED technology. Coordinates with matching LED deck light 15765 on page 24.	A popular look has a new addition with a smaller 6" shade and is available in LED. Coordinates with our 15810 & 15811 LED Domed Roof series.
Ordering Guide & Finish	15826 AZT - Textured Architectural Bronze (Marine grade powder coat) 15826 BE - Beach (Marine grade powder coat) 15826 BKT - Textured Black (Marine grade powder coat)	15870 AZT - Textured Architectural Bronze (Marine grade powder coat) 15870 BBR - Bronzed Brass 15870 BE - Beach (Marine grade powder coat) 15870 BKT - Textured Black (Marine grade powder coat)
Housing	Cast Aluminum	Cast Aluminum, Cast Brass
Light Source	3 Integrated High Output Nichia® LEDs, tightly binned for color uniformity, and constant current driver	3 Integrated High Output Nichia® LEDs, tightly binned for color uniformity, and constant current driver
Color Temp. (CCT) & CRI	3000K (-200/+125) / 80s CRI	3000K (-200/+125) / 80s CRI
Power Usage at 12V AC Input VA and Watts	4 W, 5.8 VA Multiply fixture VA by the number of fixtures used to determine size of transformer	4 W, 5.8 VA Multiply fixture VA by the number of fixtures used to determine size of transformer
Operating Voltage Range	9V-15V AC/DC with no loss in output due to constant current technology	9V-15V AC/DC with no loss in output due to constant current technology
Lumen Maint.	Tested to an L-70 of 40,000 hours	Tested to an L-70 of 40,000 hours
Total Lumens & Efficacy	3000K = 140 Lm 3000K= 35 Lm/W	3000K = 140 Lm 3000K= 35 Lm/W
Wiring	50" of usable #18-2, SPT-1-W leads. Cable connector supplied	30" of useable #18-2, SPT-1W leads. Cable connector supplied
Mounting Acces. Included	8" in-ground stake	8" In-ground stake
Optional Acces.	15601 - Surface Mounting Flange 15607 - Surface Mounting Bracket	15601 - Surface Mounting Flange 15607 - Surface Mounting Bracket
Incandescent	15326 - on page 96	15470 - on page 99
Notes	Subjected to Highly Accelerated Life Testing - 3rd party reliability testing Not for use with electronic transformers	Subjected to Highly Accelerated Life Testing - 3rd party reliability testing Not for use with electronic transformers
Fixture Photometric (fc)	Distance from Light 0' 1' 2' 3' 4' 5' 6' 7' 8' Footcandles 8.7 4.7 2.6 1.5 .67 .29 .10 - -	Distance from Light 0' 1' 2' 3' 4' 5' 6' 7' 8' Footcandles 6.11 5.71 3.97 2.55 1.64 0.90 0.50 0.40 0.31



15810 AZT, BBR, BE, BKT - LED DOME PATH LIGHT

15811 AZT, BE - LED DOME PATH LIGHT - SHORT STEM

Description	Now in Design Pro LED, a wider path and spread light that is unobtrusive in the landscape. Coordinates with the 15811 and 15870 path and spread fixtures.	A shorter version of our LED 15810 designed for use in lower planting and smaller garden areas.
Ordering Guide & Finish	15810 AZT - Textured Architectural Bronze (Marine grade powder coat) 15810 BBR - Bronzed Brass 15810 BE - Beach (Marine grade powder coat) 15810 BKT - Textured Black (Marine grade powder coat)	15811 AZT - Textured Architectural Bronze (Marine grade powder coat) 15811 BE - Beach (Marine grade powder coat)
Housing	Cast Aluminum, Cast Brass	Cast Aluminum
Light Source	3 Integrated High Output Nichia® LEDs, tightly binned for color uniformity, and constant current driver	3 Integrated High Output Nichia® LEDs, tightly binned for color uniformity, and constant current driver
Color Temp. (CCT) & CRI	3000K (-200/+125) / 80s CRI	3000K (-200/+125) / 80s CRI
Power Usage at 12V AC Input VA and Watts	4 W, 5.8 VA Multiply fixture VA by the number of fixtures used to determine size of transformer	4 W, 5.8 VA Multiply fixture VA by the number of fixtures used to determine size of transformer
Operating Voltage Range	9V-15V AC/DC with no loss in output due to constant current technology	9V-15V AC/DC with no loss in output due to constant current technology
Lumen Maint.	Tested to an L-70 of 40,000 hours	Tested to an L-70 of 40,000 hours
Total Lumens & Efficacy	3000K = 140 Lm 3000K= 35 Lm/W	3000K = 140 Lm 3000K= 35 Lm/W
Wiring	30" of useable #18-2, SPT-1W leads. Cable connector supplied	36" of useable #18-2, SPT-1W leads. Cable connector supplied
Mounting Acces. Included	8" in-ground stake	8" In-ground stake
Optional Acces.	15601 - Surface Mounting Flange 15607 - Surface Mounting Bracket	15601 - Surface Mounting Flange 15607 - Surface Mounting Bracket
Incandescent	15310 - on page 98	15410 - on page 99
Notes	Subjected to Highly Accelerated Life Testing - 3rd party reliability testing Not for use with electronic transformers	Subjected to Highly Accelerated Life Testing - 3rd party reliability testing Not for use with electronic transformers
Fixture Photometric (fc)	Distance from Light 0' 1' 2' 3' 4' 5' 6' 7' 8' Footcandles 6.47 5.50 3.82 2.20 1.44 1.07 .097 0.55 0.32	Distance from Light 0' 1' 2' 3' 4' 5' 6' 7' 8' Footcandles 12.18 11.57 6.07 3.17 1.88 1.05 0.45 0.36 0.27





KICHLER®



Quality, Style & Innovation

Kichler® Design Pro LED delivers all three.

The best value in the industry just got better. Kichler Design Pro LED is now available in a path and spread design that delivers on every level.

- Directs light where it needs to go with an even 10' to 12' spread of light, efficiently controlled, with no glare or drastic cutoffs.

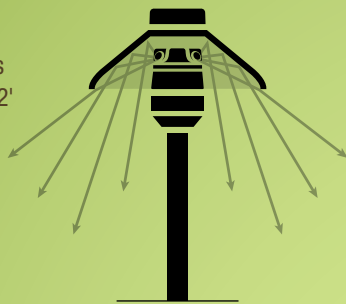

- Sealed/integrated, moisture-proof design.

- Kichler's Design Pro LED module delivers high lumen output and energy efficiency.

- Rugged construction, thick 14-gauge corrosion-resistant metals and heavy-duty 7/8" stems deliver style that's built to last.

- 9 to 15 volt operating range nearly eliminates voltage drop.



- Classic design and preferred finishes fit a wide variety of landscapes and residential settings.

- Two heights for design versatility: **15"** for smaller spreads of light or low-lying plants, and **22.5"** for larger spreads of light or larger plants.

- 15 year residential warranty, 10 year commercial warranty (see www.landscapelighting.com for complete details).



15820 CO



15821 BBR



15820 AZT, BBR, CO - LED LLENA™

15821 AZT, BBR, CO - LED LLENITA™

Description	A simple yet clean design that blends the newest LED technology with tough as nails construction. Coordinates with 15821.	A simple yet clean design that blends the newest LED technology with tough as nails construction. Coordinates with 15820.																																								
Ordering Guide & Finish	15820 AZT - Textured Architectural Bronze (Marine grade powder coat) 15820 BBR - Bronzed Brass 15820 CO - Unfinished Copper	15821 AZT - Textured Architectural Bronze (Marine grade powder coat) 15821 BBR - Bronzed Brass 15821 CO - Unfinished Copper																																								
Housing	Cast Aluminum, Cast Brass, Copper (with Natural Brass Accents) (Copper and brass will naturally patina over time)	Cast Aluminum, Cast Brass, Copper (with Natural Brass Accents) (Copper and brass will naturally patina over time)																																								
Light Source	3 Integrated High Output Nichia® LEDs, tightly binned for color uniformity, and constant current driver	3 Integrated High Output Nichia® LEDs, tightly binned for color uniformity, and constant current driver																																								
Color Temp. (CCT) & CRI	3000K (-200/+125) / 80s CRI	3000K (-200/+125) / 80s CRI																																								
Power Usage at 12V AC Input VA and Watts	4 W, 5.8 VA Multiply fixture VA by the number of fixtures used to determine size of transformer	4 W, 5.8 VA Multiply fixture VA by the number of fixtures used to determine size of transformer																																								
Operating Voltage Range	9V-15V AC/DC with no loss in output due to constant current technology	9V-15V AC/DC with no loss in output due to constant current technology																																								
Lumen Maint.	Tested to an L-70 of 40,000 hours	Tested to an L-70 of 40,000 hours																																								
Total Lumens & Efficacy	3000K = 187 Lm 3000K= 47 Lm/W	3000K = 187 Lm 3000K= 47 Lm/W																																								
Wiring	20" of usable #18-2, SPT-1-W leads. Cable connector supplied	30" of usable #18-2, SPT-1-W leads. Cable connector supplied																																								
Mounting Acces. Included	8" in-ground stake	8" In-ground stake																																								
Optional Acces.	15601 - Surface Mounting Flange 15607 - Surface Mounting Bracket	15601 - Surface Mounting Flange 15607 - Surface Mounting Bracket																																								
Notes	Subjected to Highly Accelerated Life Testing - 3rd party reliability testing Not for use with electronic transformers	Subjected to Highly Accelerated Life Testing - 3rd party reliability testing Not for use with electronic transformers																																								
Fixture Photometric (fc)	<table border="1"> <tr> <td>Distance from Light</td> <td>0'</td><td>1'</td><td>2'</td><td>3'</td><td>4'</td><td>5'</td><td>6'</td><td>7'</td><td>8'</td> </tr> <tr> <td>Footcandles</td> <td>10.75</td><td>5.60</td><td>2.24</td><td>0.66</td><td>0.22</td><td>0.10</td><td>0.07</td><td>0.03</td><td>0.01</td> </tr> </table>	Distance from Light	0'	1'	2'	3'	4'	5'	6'	7'	8'	Footcandles	10.75	5.60	2.24	0.66	0.22	0.10	0.07	0.03	0.01	<table border="1"> <tr> <td>Distance from Light</td> <td>0'</td><td>1'</td><td>2'</td><td>3'</td><td>4'</td><td>5'</td><td>6'</td><td>7'</td><td>8'</td> </tr> <tr> <td>Footcandles</td> <td>20.70</td><td>6.60</td><td>1.00</td><td>0.28</td><td>0.10</td><td>0.06</td><td>0.01</td><td>--</td><td>--</td> </tr> </table>	Distance from Light	0'	1'	2'	3'	4'	5'	6'	7'	8'	Footcandles	20.70	6.60	1.00	0.28	0.10	0.06	0.01	--	--
Distance from Light	0'	1'	2'	3'	4'	5'	6'	7'	8'																																	
Footcandles	10.75	5.60	2.24	0.66	0.22	0.10	0.07	0.03	0.01																																	
Distance from Light	0'	1'	2'	3'	4'	5'	6'	7'	8'																																	
Footcandles	20.70	6.60	1.00	0.28	0.10	0.06	0.01	--	--																																	

Design Pro LED 12V Deck & Patio

Guide and gather beneath the beauty of LED.





15750 TZT - LED VINTAGE PARK™

15763 TZT - LED DECORATIVE HAMMERED ROOF

Description	19 th century charm with the energy efficient benefit of LED technology.	Traditional designed pierced shade and scalloped edge combines with the energy efficient benefit of LED technology. Coordinates with matching LED path light 15871 and 15843 on page 10.																																																																
Ordering Guide & Finish	15750 TZT - Textured Tannery Bronze™ (Marine grade powder coat)	15763 TZT - Textured Tannery Bronze™ (Marine grade powder coat)																																																																
Housing	Cast Aluminum	Brass																																																																
Light Source	1 Integrated High Output Nichia® LED, tightly binned for color uniformity, and constant current driver	1 Integrated High Output Nichia® LED, tightly binned for color uniformity, and constant current driver																																																																
Color Temp. (CCT) & CRI	3000K (-200/+125) / 80s CRI	3000K (-200/+125) / 80s CRI																																																																
Power Usage at 12V AC Input VA and Watts	1.9 W, 2.4 VA Multiply fixture VA by the number of fixtures used to determine size of transformer	1.9 W, 2.4 VA Multiply fixture VA by the number of fixtures used to determine size of transformer																																																																
Operating Voltage Range	9V- 15V AC/DC with no loss in output due to constant current technology	9V- 15V AC/DC with no loss in output due to constant current technology																																																																
Lumen Maint.	Tested to an L-70 of 40,000 hours	Tested to an L-70 of 40,000 hours																																																																
Total Lumens & Efficacy	3000K = 50 Lm 3000K= 26 Lm/W	3000K = 50 Lm 3000K= 26 Lm/W																																																																
Wiring	72" of usable #18-2, SPT-1-W leads. Cable connector supplied	72" of usable #18-2, SPT-1-W leads. Cable connector supplied																																																																
Mounting Acces. (Included)	Stainless steel mounting bracket	Stainless steel mounting bracket																																																																
Notes	Subjected to Highly Accelerated Life Testing - 3rd party reliability testing Not for use with electronic transformers	Subjected to Highly Accelerated Life Testing - 3rd party reliability testing Not for use with electronic transformers																																																																
Photometric with Supplied Lamp	<table border="1"> <thead> <tr> <th>Mounting Height</th> <th>0'</th> <th>0.5'</th> <th>1'</th> <th>2'</th> <th>3'</th> <th>4'</th> <th>5'</th> </tr> </thead> <tbody> <tr> <td>6"</td> <td>61.9</td> <td>13.3</td> <td>2.0</td> <td>0.1</td> <td>0.04</td> <td>0.01</td> <td>-</td> </tr> <tr> <td>12"</td> <td>14.7</td> <td>8.4</td> <td>3.3</td> <td>0.5</td> <td>0.1</td> <td>0.03</td> <td>-</td> </tr> <tr> <td>30"</td> <td>2.2</td> <td>2.0</td> <td>1.6</td> <td>0.8</td> <td>0.36</td> <td>0.15</td> <td>-</td> </tr> </tbody> </table>	Mounting Height	0'	0.5'	1'	2'	3'	4'	5'	6"	61.9	13.3	2.0	0.1	0.04	0.01	-	12"	14.7	8.4	3.3	0.5	0.1	0.03	-	30"	2.2	2.0	1.6	0.8	0.36	0.15	-	<table border="1"> <thead> <tr> <th>Mounting Height</th> <th>0'</th> <th>0.5'</th> <th>1'</th> <th>2'</th> <th>3'</th> <th>4'</th> <th>5'</th> </tr> </thead> <tbody> <tr> <td>6"</td> <td>69.4</td> <td>14.4</td> <td>1.8</td> <td>0.08</td> <td>0.03</td> <td>-</td> <td>-</td> </tr> <tr> <td>12"</td> <td>15.3</td> <td>8.6</td> <td>3.4</td> <td>0.37</td> <td>0.08</td> <td>0.02</td> <td>-</td> </tr> <tr> <td>30"</td> <td>2.4</td> <td>2.0</td> <td>1.6</td> <td>0.56</td> <td>0.36</td> <td>0.1</td> <td>-</td> </tr> </tbody> </table>	Mounting Height	0'	0.5'	1'	2'	3'	4'	5'	6"	69.4	14.4	1.8	0.08	0.03	-	-	12"	15.3	8.6	3.4	0.37	0.08	0.02	-	30"	2.4	2.0	1.6	0.56	0.36	0.1	-
	Mounting Height	0'	0.5'	1'	2'	3'	4'	5'																																																										
	6"	61.9	13.3	2.0	0.1	0.04	0.01	-																																																										
	12"	14.7	8.4	3.3	0.5	0.1	0.03	-																																																										
30"	2.2	2.0	1.6	0.8	0.36	0.15	-																																																											
Mounting Height	0'	0.5'	1'	2'	3'	4'	5'																																																											
6"	69.4	14.4	1.8	0.08	0.03	-	-																																																											
12"	15.3	8.6	3.4	0.37	0.08	0.02	-																																																											
30"	2.4	2.0	1.6	0.56	0.36	0.1	-																																																											

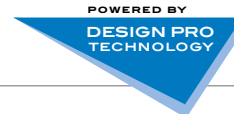

15765 AZT, BBR, BE, BKT, WHT - LED MINI DECK LIGHT

Description	Versatile mini size and simple styling for multiple applications with the added benefit of LED technology.																																
Ordering Guide & Finish	15765 AZT - Textured Architectural Bronze (Marine grade powder coat) 15765 BBR - Bronzed Brass 15765 BE - Beach (Marine grade powder coat) 15765 BKT - Textured Black (Marine grade powder coat) 15765 WHT - Textured White (Marine grade powder coat)																																
Housing	Cast Aluminum or Cast Brass																																
Light Source	2 Integrated High Output Nichia® LEDs, tightly binned for color uniformity, and constant current driver																																
Color Temp. (CCT) & CRI	3000K (-200/+125) / 80s CRI																																
Power Usage at 12V AC Input VA and Watts	1.9W, 2.4 VA Multiply fixture VA by the number of fixtures used to determine size of transformer																																
Operating Voltage Range	9V-15V AC/DC with no loss in output due to constant current technology																																
Lumen Maint.	Tested to an L-70 of 40,000 hours																																
Total Lumens & Efficacy	3000K = 50 Lm 3000K= 26 Lm/W																																
Wiring	72" of usable #18-2, SPT-1-W leads. Cable connector supplied. WHT has coordinating white leads																																
Mounting Acces. Included	Stainless steel mounting bracket																																
Incandescent	15065 - on page 109																																
Notes	Subjected to Highly Accelerated Life Testing - 3rd party reliability testing Not for use with electronic transformers																																
Photometric with Supplied Lamp	<table border="1"> <thead> <tr> <th>Mounting Height</th> <th>0'</th> <th>0.5'</th> <th>1'</th> <th>2'</th> <th>3'</th> <th>4'</th> <th>5'</th> </tr> </thead> <tbody> <tr> <td>6"</td> <td>53.3</td> <td>10.9</td> <td>1.7</td> <td>0.09</td> <td>0.03</td> <td>-</td> <td>-</td> </tr> <tr> <td>12"</td> <td>12.25</td> <td>7.1</td> <td>2.8</td> <td>0.44</td> <td>0.09</td> <td>0.02</td> <td>-</td> </tr> <tr> <td>30"</td> <td>1.9</td> <td>1.8</td> <td>1.4</td> <td>0.72</td> <td>0.33</td> <td>0.14</td> <td>-</td> </tr> </tbody> </table>	Mounting Height	0'	0.5'	1'	2'	3'	4'	5'	6"	53.3	10.9	1.7	0.09	0.03	-	-	12"	12.25	7.1	2.8	0.44	0.09	0.02	-	30"	1.9	1.8	1.4	0.72	0.33	0.14	-
Mounting Height	0'	0.5'	1'	2'	3'	4'	5'																										
6"	53.3	10.9	1.7	0.09	0.03	-	-																										
12"	12.25	7.1	2.8	0.44	0.09	0.02	-																										
30"	1.9	1.8	1.4	0.72	0.33	0.14	-																										



15764 AZT, BBR, WHT - LED HALF MOON | **15773/15774 AZT - LED BRICK LIGHT**

Description	Understated, transitional style for deck and patio with the added benefit of LED technology.	Designed to be integrated into brick wall during construction. LED version is also usable in vertical risers. Casts a low, even spread of energy efficient LED light. Available with or without louvers.																																																																																																								
Ordering Guide & Finish	15764 AZT - Textured Architectural Bronze (Marine grade powder coat) 15764 BBR - Bronzed Brass 15764 WHT - Textured White (Marine grade powder coat)	15773 AZT - Textured Architectural Bronze with louver face (Marine grade powder coat) 15774 AZT - Textured Architectural Bronze with heat resistant glass lens (Marine grade powder coat)																																																																																																								
Housing	Aluminum or Cast Brass with satin-etched lens	Cast Aluminum																																																																																																								
Light Source	1 Integrated High Output Nichia® LED, tightly binned for color uniformity, and constant current driver	2 Integrated High Output Nichia® LEDs, tightly binned for color uniformity, and constant current driver																																																																																																								
Color Temp. (CCT) & CRI	3000K (-200/+125) / 80s CRI	3000K (-200/+125) / 80s CRI																																																																																																								
Power Usage at 12V AC Input VA and Watts	1.9 W, 2.4 VA Multiply fixture VA by the number of fixtures used to determine size of transformer	3.8 W, 4.8 VA Multiply fixture VA by the number of fixtures used to determine size of transformer																																																																																																								
Operating Voltage Range	9V-15V AC/DC with no loss in output due to constant current technology	9V-15V AC/DC with no loss in output due to constant current technology																																																																																																								
Lumen Maint.	Tested to an L-70 of 40,000 hours	Tested to an L-70 of 40,000 hours																																																																																																								
Total Lumens & Efficacy	3000K = 50 Lm 3000K = 26 Lm/W	3000K = 100 Lm 3000K = 26 Lm/W																																																																																																								
Wiring	72" of usable #18-2, SPT-1-W leads. Cable connector supplied. WHT has coordinating white leads.	Wire connection must be made inside fixture																																																																																																								
Mounting Acces.	Stainless steel mounting bracket (included)	Stainless steel mounting hardware and junction box (included)																																																																																																								
Incandescent	15064 - on page 109	15073 - on page 113, 15074 - on page 113																																																																																																								
Notes	Subjected to Highly Accelerated Life Testing - 3rd party reliability testing. Not for use with electronic transformers	Subjected to Highly Accelerated Life Testing - 3rd party reliability testing. Not for use with electronic transformers																																																																																																								
Photometric with Supplied Lamp	<table border="1"> <thead> <tr> <th>Mounting Height</th> <th>0'</th> <th>0.5'</th> <th>1'</th> <th>2'</th> <th>3'</th> <th>4'</th> <th>5'</th> </tr> </thead> <tbody> <tr> <td>6"</td> <td>71.5</td> <td>18.7</td> <td>2.5</td> <td>0.14</td> <td>0.04</td> <td>0.01</td> <td>-</td> </tr> <tr> <td>12"</td> <td>16.1</td> <td>10.8</td> <td>4.2</td> <td>0.57</td> <td>0.13</td> <td>0.04</td> <td>0.04</td> </tr> <tr> <td>30"</td> <td>2.7</td> <td>2.5</td> <td>2.1</td> <td>1.04</td> <td>0.43</td> <td>.2</td> <td>0.9</td> </tr> </tbody> </table>	Mounting Height	0'	0.5'	1'	2'	3'	4'	5'	6"	71.5	18.7	2.5	0.14	0.04	0.01	-	12"	16.1	10.8	4.2	0.57	0.13	0.04	0.04	30"	2.7	2.5	2.1	1.04	0.43	.2	0.9	<table border="1"> <thead> <tr> <th>Mounting Height</th> <th>0'</th> <th>0.5'</th> <th>1'</th> <th>1.5'</th> <th>2'</th> <th>2.5'</th> <th>3'</th> <th>4'</th> </tr> </thead> <tbody> <tr> <td>12"</td> <td>0.22</td> <td>2.08</td> <td>1.87</td> <td>1.85</td> <td>1.3</td> <td>0.85</td> <td>-</td> <td>-</td> </tr> <tr> <td>24"</td> <td>0.12</td> <td>0.16</td> <td>0.29</td> <td>0.72</td> <td>0.77</td> <td>0.68</td> <td>0.52</td> <td>-</td> </tr> <tr> <td>36"</td> <td>0.04</td> <td>0.05</td> <td>0.09</td> <td>0.12</td> <td>0.16</td> <td>.026</td> <td>.026</td> <td>-</td> </tr> <tr> <td>¹⁵⁷⁷⁴ Mounting Height</td> <td>0'</td> <td>0.5'</td> <td>1'</td> <td>1.5'</td> <td>2'</td> <td>2.5'</td> <td>3'</td> <td>4'</td> </tr> <tr> <td>12"</td> <td>2.02</td> <td>4.17</td> <td>3.0</td> <td>2.0</td> <td>1.0</td> <td>0.68</td> <td>0.48</td> <td>-</td> </tr> <tr> <td>24"</td> <td>0.23</td> <td>0.61</td> <td>0.96</td> <td>0.9</td> <td>0.75</td> <td>0.62</td> <td>0.51</td> <td>-</td> </tr> <tr> <td>36"</td> <td>0.05</td> <td>0.16</td> <td>0.27</td> <td>0.38</td> <td>0.38</td> <td>0.35</td> <td>0.31</td> <td>-</td> </tr> </tbody> </table>	Mounting Height	0'	0.5'	1'	1.5'	2'	2.5'	3'	4'	12"	0.22	2.08	1.87	1.85	1.3	0.85	-	-	24"	0.12	0.16	0.29	0.72	0.77	0.68	0.52	-	36"	0.04	0.05	0.09	0.12	0.16	.026	.026	-	¹⁵⁷⁷⁴ Mounting Height	0'	0.5'	1'	1.5'	2'	2.5'	3'	4'	12"	2.02	4.17	3.0	2.0	1.0	0.68	0.48	-	24"	0.23	0.61	0.96	0.9	0.75	0.62	0.51	-	36"	0.05	0.16	0.27	0.38	0.38	0.35	0.31	-
Mounting Height	0'	0.5'	1'	2'	3'	4'	5'																																																																																																			
6"	71.5	18.7	2.5	0.14	0.04	0.01	-																																																																																																			
12"	16.1	10.8	4.2	0.57	0.13	0.04	0.04																																																																																																			
30"	2.7	2.5	2.1	1.04	0.43	.2	0.9																																																																																																			
Mounting Height	0'	0.5'	1'	1.5'	2'	2.5'	3'	4'																																																																																																		
12"	0.22	2.08	1.87	1.85	1.3	0.85	-	-																																																																																																		
24"	0.12	0.16	0.29	0.72	0.77	0.68	0.52	-																																																																																																		
36"	0.04	0.05	0.09	0.12	0.16	.026	.026	-																																																																																																		
¹⁵⁷⁷⁴ Mounting Height	0'	0.5'	1'	1.5'	2'	2.5'	3'	4'																																																																																																		
12"	2.02	4.17	3.0	2.0	1.0	0.68	0.48	-																																																																																																		
24"	0.23	0.61	0.96	0.9	0.75	0.62	0.51	-																																																																																																		
36"	0.05	0.16	0.27	0.38	0.38	0.35	0.31	-																																																																																																		

DESIGN PRO LED 12V DECK & PATIO

D

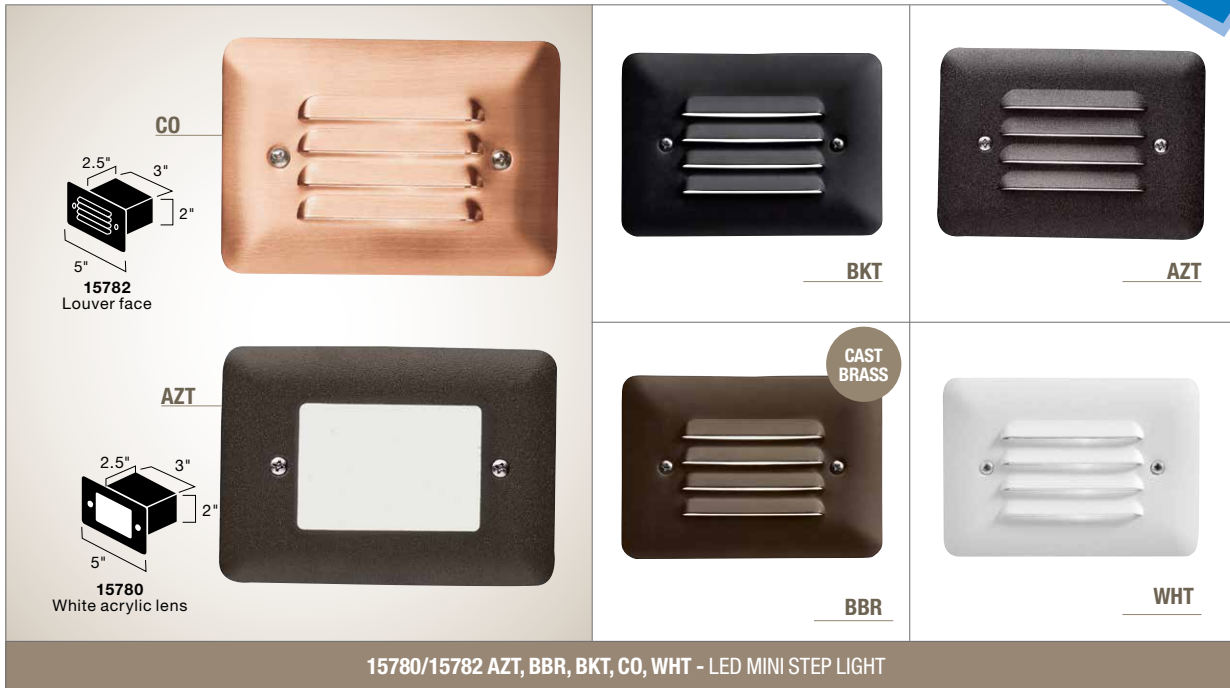

15780/15782 AZT, BBR, BKT, CO, WHT - LED MINI STEP LIGHT

Description	Designed to be integrated into outdoor steps. Casts a low, even spread of energy efficient LED light. Available with louvered faceplate or with acrylic lens as shown above.																																																							
Ordering Guide & Finish	15780 AZT - Acrylic Lens, Textured Architectural Bronze (Marine grade powder coat) 15782 AZT - Louvered Lens, Textured Architectural Bronze (Marine grade powder coat) 15782 BBR - Louvered Lens, Bronzed Brass 15782 BKT - Louvered Lens, Textured Black (Marine grade powder coat) 15782 CO - Louvered Lens, Unfinished Copper 15782 WHT - Louvered Lens, Textured White (Marine grade powder coat)																																																							
Housing	Aluminum, Brass or Copper with white reflector. Zinc plated steel housing. (Copper will naturally patina over time)																																																							
Light Source	1 Integrated High Output Nichia® LED, tightly binned for color uniformity, and constant current driver																																																							
Color Temp. (CCT) & CRI	3000K (-200/+125) / 80s CRI																																																							
Power Usage at 12V AC Input VA and Watts	1.9W 2.4 VA Multiply fixture VA by the number of fixtures used to determine size of transformer																																																							
Operating Voltage Range	9V-15V AC/DC with no loss in output due to constant current technology																																																							
Lumen Maint.	Tested to an L-70 of 40,000 hours																																																							
Total Lumens & Efficacy	3000K = 50 Lm 3000K = 26 Lm/W																																																							
Wiring	Wire connection must be made inside fixture																																																							
Mounting Acces.	Mounting hardware and junction box																																																							
Incandescent	15072 - on page 113, 15070 - on page 113																																																							
Notes	Subjected to Highly Accelerated Life Testing - 3rd party reliability testing. Not for use with electronic transformers																																																							
Fixture Photometric (fc)	<table border="1"> <thead> <tr> <th>15780 Mounting Height</th> <th>0'</th> <th>0.5'</th> <th>1'</th> <th>1.5'</th> <th>2'</th> <th>2.5'</th> <th>3'</th> <th>4'</th> </tr> </thead> <tbody> <tr> <td>6"</td> <td>2.9</td> <td>3.6</td> <td>1.63</td> <td>0.8</td> <td>0.4</td> <td>0.26</td> <td>0.17</td> <td>-</td> </tr> <tr> <td>12"</td> <td>0.45</td> <td>1.03</td> <td>1.03</td> <td>0.69</td> <td>0.45</td> <td>0.32</td> <td>0.23</td> <td>-</td> </tr> </tbody> </table>	15780 Mounting Height	0'	0.5'	1'	1.5'	2'	2.5'	3'	4'	6"	2.9	3.6	1.63	0.8	0.4	0.26	0.17	-	12"	0.45	1.03	1.03	0.69	0.45	0.32	0.23	-	<table border="1"> <thead> <tr> <th>15782 Mounting Height</th> <th>0'</th> <th>0.5'</th> <th>1'</th> <th>1.5'</th> <th>2'</th> <th>2.5'</th> <th>3'</th> <th>4'</th> </tr> </thead> <tbody> <tr> <td>6"</td> <td>1.2</td> <td>1.96</td> <td>0.9</td> <td>0.4</td> <td>0.16</td> <td>0.07</td> <td>0.04</td> <td>-</td> </tr> <tr> <td>12"</td> <td>0.26</td> <td>0.55</td> <td>0.15</td> <td>0.46</td> <td>0.23</td> <td>-</td> <td>-</td> <td>-</td> </tr> </tbody> </table>	15782 Mounting Height	0'	0.5'	1'	1.5'	2'	2.5'	3'	4'	6"	1.2	1.96	0.9	0.4	0.16	0.07	0.04	-	12"	0.26	0.55	0.15	0.46	0.23	-	-	-
15780 Mounting Height	0'	0.5'	1'	1.5'	2'	2.5'	3'	4'																																																
6"	2.9	3.6	1.63	0.8	0.4	0.26	0.17	-																																																
12"	0.45	1.03	1.03	0.69	0.45	0.32	0.23	-																																																
15782 Mounting Height	0'	0.5'	1'	1.5'	2'	2.5'	3'	4'																																																
6"	1.2	1.96	0.9	0.4	0.16	0.07	0.04	-																																																
12"	0.26	0.55	0.15	0.46	0.23	-	-	-																																																



KICHLER®

Design Pro LED 12V Hardscape, Deck, Step & Bench

LED like you've never seen it.



Discover LED like you've never seen it.

Unique Hardscape LED light fixtures that are:

- Available in multiple Kelvin temperature options: warm white 2700K, pure white 3000K and cool white 4200K.
- Available in 1, 3, 6, and 9 LED fixtures
- Long-life LED light source — 40,000 hours at industry standard L70
- Tested to withstand the elements for years of enjoyment
- Easy to install
- Easily adapts to almost any hardscape, deck, step, or bench application
- Finishes compliment popular stone and decking options: Textured Architectural Bronze, Bronzed Brass, Copper, Gray, Sand and Textured White



Multiple Kelvin Temperatures

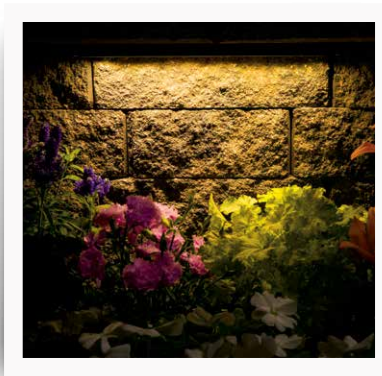

Warm White
2700K

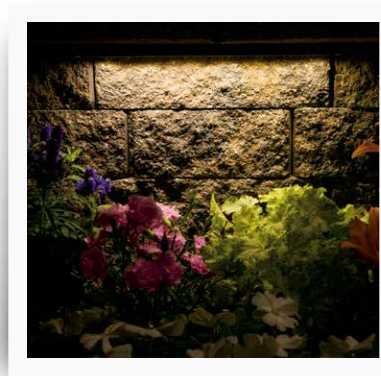

Pure White
3000K

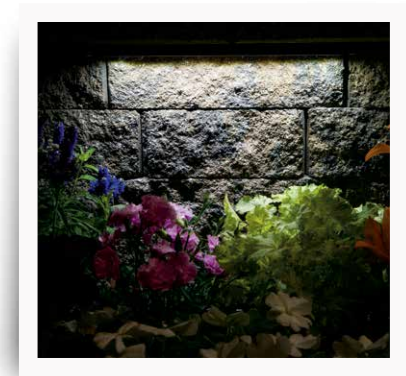

Cool White
4200K

Maximum Flexibility

The easy installation, low voltage usage, low profile (.66" wide) and low heat output of Design Pro LED enables them to be used in a variety of outdoor applications.

- Retaining walls of all types – new and existing construction
- Brick or stone columns
- Under all types of steps, including wood, composite, stone and brick, etc., with and without risers
- Under deck and chair/hand and fence rails
- Lips or the undersides of a wide variety of outdoor surfaces
- Pergolas
- Outdoor kitchen and bar areas (under lips and toe kicks)
- Raised beds/planters
- Boat docks (as permitted by local codes)
- Customize illumination by mounting farther back, for a scalloped effect, or forward for a more even effect



Under decks, rails and foot bridges



Privacy fence

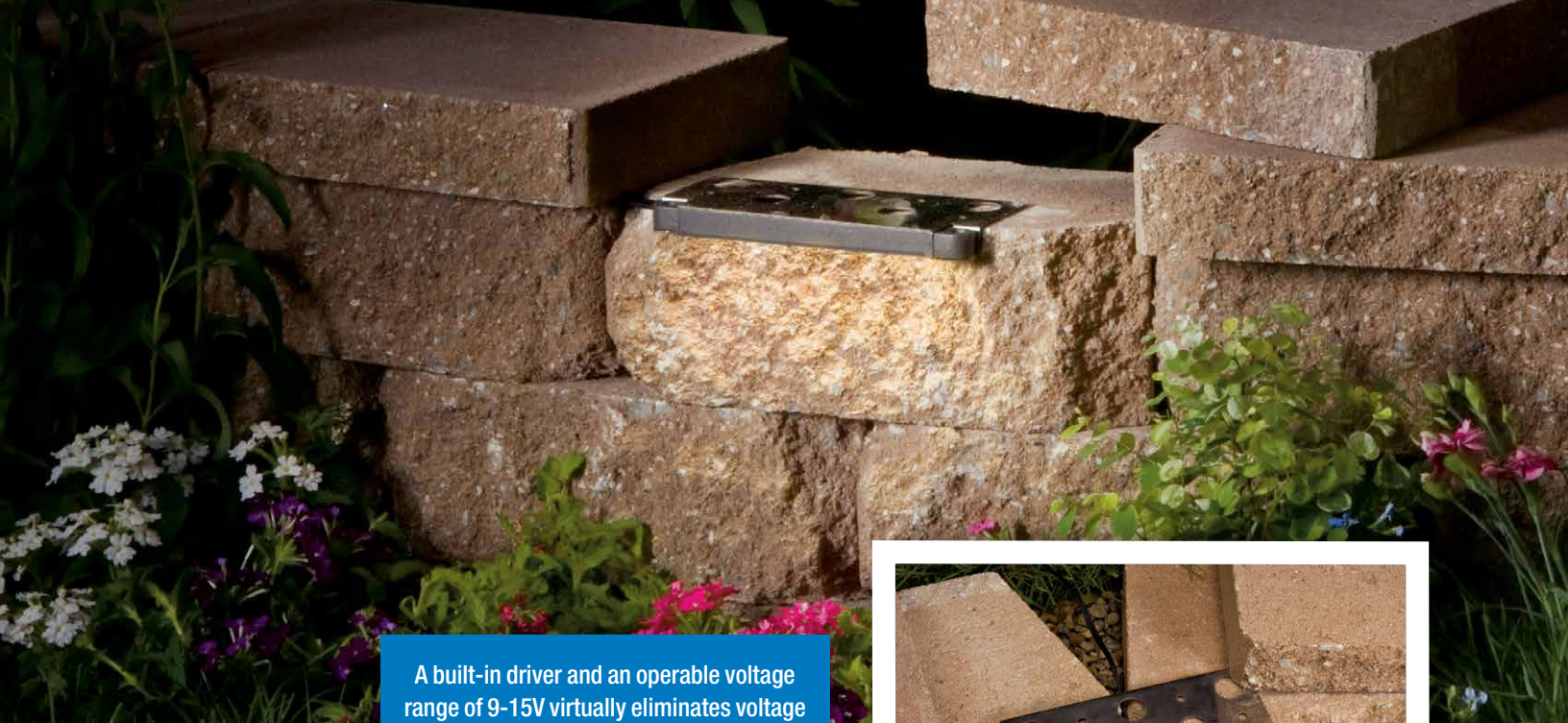

A built-in driver and an operable voltage range of 9-15V virtually eliminates voltage drop in every Design Pro LED Hardscape, Deck, Step & Bench Light fixture.



Easy to Install

Thoughtful installation, so whether new or existing construction, you can design effectively and install it efficiently.



NEW CONSTRUCTION
LED light fixture and stainless steel mounting bracket are preassembled and ready to install.

RETROFIT
Need to mount on a flat or vertical surface? No problem. The available flat mount accessory brackets (15716 SS, 15717 SS, 15718 SS, 15719 SS) allow for a variety of retrofit and new build applications.

DECK, STEP & BENCH INSTALLATION
Don't need the brackets? Don't pay for them. Kichler provides the product options that make it convenient for your specific job. For non-hardscape applications, the threaded screw holders also allow for easy installation. In fact, you can mount these LED fixtures on any surface where you can drill two holes.

Hardscape Spacing Recommendations

Item ID	(3.0") 15734, 15744	(6.9") 15735, 15745	(12.9") 15736, 15746	(18.9") 15755, 15756
MTG HT	RECOMMENDED SPACING (CENTER TO CENTER)			
12"	12"	2'	3'	4'
24"	9"	3'	4'	5'
36"	7"	4'	6'	8'



KICHLER®

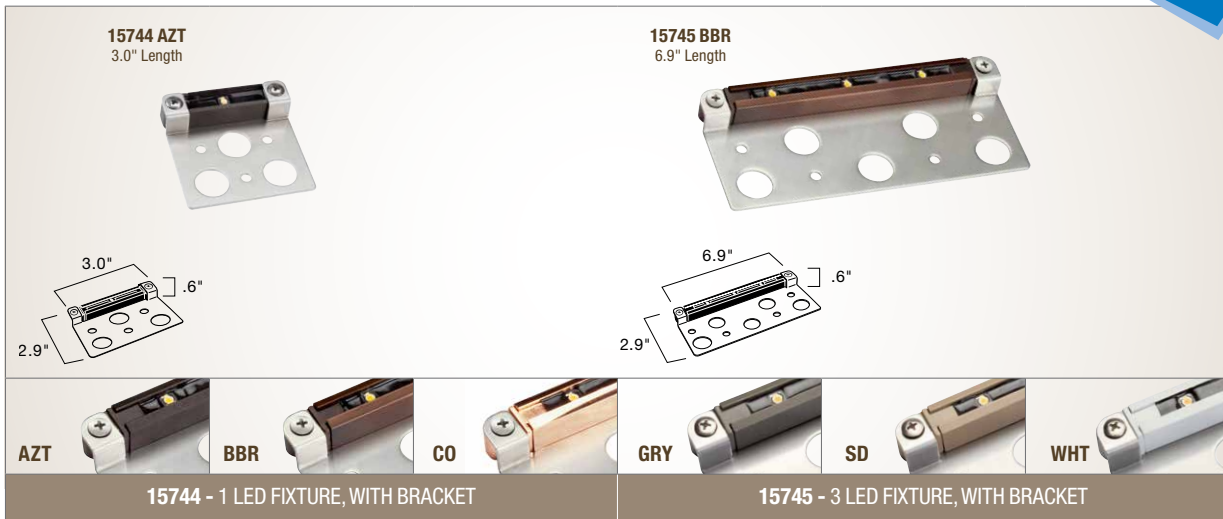

	15744 - 1 LED FIXTURE, WITH BRACKET			15745 - 3 LED FIXTURE, WITH BRACKET		
Ordering Guide	2700K Warm White	3000K Pure White	4200K Cool White	2700K Warm White	3000K Pure White	4200K Cool White
	15744 AZT27 15744 BBR27 15744 CO27 15744 GRY27 15744 SD27 15744 WHT27	15744 AZT30 15744 BBR30 15744 CO30 15744 GRY30 15744 SD30 15744 WHT30	15744 AZT42 15744 BBR42 15744 CO42 15744 GRY42 15744 SD42 15744 WHT42	15745 AZT27 15745 BBR27 15745 CO27 15745 GRY27 15745 SD27 15745 WHT27	15745 AZT30 15745 BBR30 15745 CO30 15745 GRY30 15745 SD30 15745 WHT30	15745 AZT42 15745 BBR42 15745 CO42 15745 GRY42 15745 SD42 15745 WHT42
Finish Guide	AZT - Textured Architectural Bronze (Marine grade powder coat) BBR - Bronzed Brass CO - Unfinished Copper GRY - Textured Gray (Marine grade powder coat) SD - Textured Sand (Marine grade powder coat) WHT - Textured White (Marine grade powder coat)			AZT - Textured Architectural Bronze (Marine grade powder coat) BBR - Bronzed Brass CO - Unfinished Copper GRY - Textured Gray (Marine grade powder coat) SD - Textured Sand (Marine grade powder coat) WHT - Textured White (Marine grade powder coat)		
Housing	Cast Aluminum, Cast Brass, Copper Plated Brass (Copper will naturally patina over time)			Cast Aluminum, Cast Brass, Copper Plated Brass (Copper will naturally patina over time)		
Light Source	1 Integrated High Output Nichia® LED, tightly binned for color uniformity, and constant current driver			3 Integrated High Output Nichia® LEDs, tightly binned for color uniformity, and constant current driver		
Beam Spread	55°			55°		
Color Temp. (CCT) & CRI	2700K (-280/+0) 3000K (-200/+175) 4200K (-400/+400) / 80s CRI			2700K (-280/+0) 3000K (-200/+175) 4200K (-400/+400) / 80s CRI		
Power Usage at 12V AC Input VA and Watts	0.19 W, 0.28 VA Multiply fixture VA by the number of fixtures used to determine size of transformer			.75 W, 1.3 VA Multiply fixture VA by the number of fixtures used to determine size of transformer		
Operating Voltage Range	9V-15V AC/DC with no loss in output due to constant current technology			9V-15V AC/DC with no loss in output due to constant current technology		
Lumen Main.	Tested to an L-70 of 40,000 hours			Tested to an L-70 of 40,000 hours		
Total Lumens & Efficacy	2700K = 8.4 Lm 2700K = 44 Lm/W 3000K = 8.6 Lm 3000K = 45 Lm/W 4200K = 11.0 Lm 4200K = 58 Lm/W			2700K = 34.7 Lm 2700K = 46 Lm/W 3000K = 44.5 Lm 3000K = 59 Lm/W 4200K = 51.9 Lm 4200K = 69 Lm/W		
Wiring	70" of usable #18-2, SPT-1W leads. Pro series wire connectors supplied			70" of usable #18-2, SPT-1W leads. Pro series wire connectors supplied		
Mounting Acces.	Stainless steel masonry bracket and mounting screws			Stainless steel masonry bracket and mounting screws		
Optional Acces.	15716 SS - 1 LED Accessory Bracket			15717 SS - 3 LED Accessory Bracket		
Notes	Subjected to Highly Accelerated Life Testing - 3rd party reliability testing Not for use with electronic transformers			Subjected to Highly Accelerated Life Testing - 3rd party reliability testing Not for use with electronic transformers		
Fixture Photometric* (fc)	Mounting Height	0'	1'	2'	3'	4'
	foot candles at 12"	8.65	1.10	0.07	0.03	0.02
	foot candles at 24"	2.08	0.98	0.30	0.06	0.04
	foot candles at 36"	0.95	0.61	0.30	0.14	0.06
	Mounting Height	0'	1'	2'	3'	4'
	foot candles at 12"	43.7	4.89	0.31	0.12	0.07
	foot candles at 24"	10.7	4.87	1.29	0.12	0.08
	foot candles at 36"	4.96	3.14	1.56	0.67	0.24

*Values stated for 3000K. +10% for 4200K. -10% for 2700K.

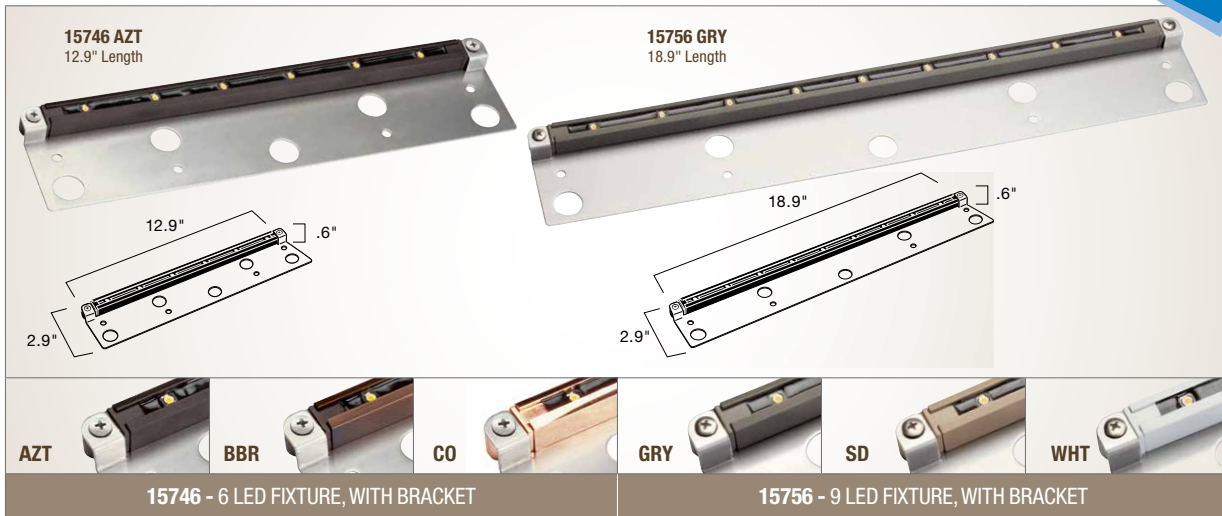

	15746 - 6 LED FIXTURE, WITH BRACKET			15756 - 9 LED FIXTURE, WITH BRACKET		
Ordering Guide	2700K Warm White	3000K Pure White	4200K Cool White	2700K Warm White	3000K Pure White	4200K Cool White
	15746 AZT27 15746 BBR27 15746 CO27 15746 GRY27 15746 SD27 15746 WHT27	15746 AZT30 15746 BBR30 15746 CO30 15746 GRY30 15746 SD30 15746 WHT30	15746 AZT42 15746 BBR42 15746 CO42 15746 GRY42 15746 SD42 15746 WHT42	15756 AZT27 15756 BBR27 15756 CO27 15756 GRY27 15756 SD27 15756 WHT27	15756 AZT30 15756 BBR30 15756 CO30 15756 GRY30 15756 SD30 15756 WHT30	15756 AZT42 15756 BBR42 15756 CO42 15756 GRY42 15756 SD42 15756 WHT42
Finish Guide	AZT - Textured Architectural Bronze (Marine grade powder coat) BBR - Bronzed Brass CO - Unfinished Copper GRY - Textured Gray (Marine grade powder coat) SD - Textured Sand (Marine grade powder coat) WHT - Textured White (Marine grade powder coat)			AZT - Textured Architectural Bronze (Marine grade powder coat) BBR - Bronzed Brass CO - Unfinished Copper GRY - Textured Gray (Marine grade powder coat) SD - Textured Sand (Marine grade powder coat) WHT - Textured White (Marine grade powder coat)		
Housing	Cast Aluminum, Cast Brass, Copper Plated Brass (Copper will naturally patina over time)			Cast Aluminum, Cast Brass, Copper Plated Brass (Copper will naturally patina over time)		
Light Source	6 Integrated High Output Nichia® LEDs, tightly binned for color uniformity, and constant current driver			9 Integrated High Output Nichia® LEDs, tightly binned for color uniformity, and constant current driver		
Beam Spread	55°			55°		
Color Temp. (CCT) & CRI	2700K (-280/+0) 3000K (-200/+175) 4200K (-400/+400) / 80s CRI			2700K (-280/+0) 3000K (-200/+175) 4200K (-400/+400) / 80s CRI		
Power Usage at 12V AC Input VA and Watts	1.4 W, 2.4 VA Multiply fixture VA by the number of fixtures used to determine size of transformer			2.2 W, 3.7 VA Multiply fixture VA by the number of fixtures used to determine size of transformer		
Operating Voltage Range	9V-15V AC/DC with no loss in output due to constant current technology			9V-15V AC/DC with no loss in output due to constant current technology		
Lumen Main.	Tested to an L-70 of 40,000 hours			Tested to an L-70 of 40,000 hours		
Total Lumens & Efficacy	2700K = 69.5 Lm 2700K = 49 Lm/W 3000K = 88 Lm 3000K = 63 Lm/W 4200K = 101.5 Lm 4200K = 73 Lm/W			2700K = 104.2 Lm 2700K = 47 Lm/W 3000K = 132 Lm 3000K = 60 Lm/W 4200K = 151.8 Lm 4200K = 69 Lm/W		
Wiring	70" of usable #18-2, SPT-1W leads. Pro series wire connectors supplied			70" of usable #18-2, SPT-1W leads. Pro series wire connectors supplied		
Mounting Acces.	Stainless steel masonry bracket and mounting screws			Stainless steel masonry bracket and mounting screws		
Optional Acces.	15718 SS - 6 LED Accessory Bracket			15719 SS - 9 LED Accessory Bracket		
Notes	Subjected to Highly Accelerated Life Testing - 3rd party reliability testing Not for use with electronic transformers			Subjected to Highly Accelerated Life Testing - 3rd party reliability testing Not for use with electronic transformers		
Fixture Photometric* (fc)	Mounting Height	0'	1'	2'	3'	4'
	foot candles at 12"	65.10	9.74	0.60	0.22	0.14
	foot candles at 24"	19.64	9.15	2.72	0.48	0.24
	foot candles at 36"	9.16	5.82	2.74	1.00	0.30
	Mounting Height	0'	1'	2'	3'	4'
	foot candles at 12"	80.40	12.00	1.08	0.36	0.21
	foot candles at 24"	26.81	13.13	3.81	0.91	0.39
	foot candles at 36"	13.51	8.43	4.55	1.78	0.62

*Values stated for 3000K. +10% for 4200K. -10% for 2700K.

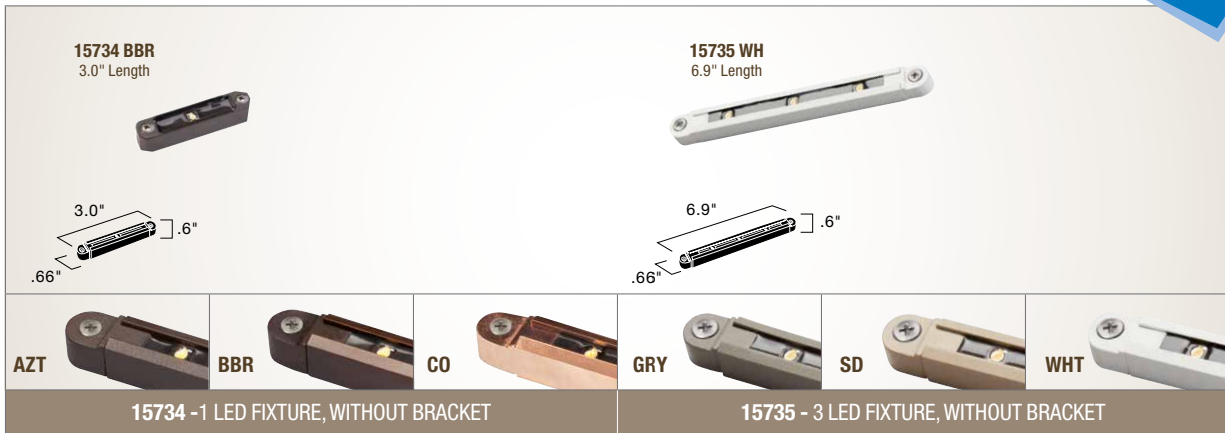

	15734 - 1 LED FIXTURE, WITHOUT BRACKET	15735 - 3 LED FIXTURE, WITHOUT BRACKET																																																
Ordering Guide & Finish	15734 AZT30 - Textured Architectural Bronze (Marine grade powder coat) 15734 BBR30 - Bronzed Brass 15734 CO30 - Unfinished Copper 15734 GRY30 - Textured Gray (Marine grade powder coat) 15734 SD30 - Textured Sand (Marine grade powder coat) 15734 WHT30 - Textured White (Marine grade powder coat)	15735 AZT30 - Textured Architectural Bronze (Marine grade powder coat) 15735 BBR30 - Bronzed Brass 15735 CO30 - Unfinished Copper 15735 GRY30 - Textured Gray (Marine grade powder coat) 15735 SD30 - Textured Sand (Marine grade powder coat) 15735 WHT30 - Textured White (Marine grade powder coat)																																																
Housing	Cast Aluminum, Cast Brass, Copper Plated Brass (Copper will naturally patina over time.)	Cast Aluminum, Cast Brass, Copper Plated Brass (Copper will naturally patina over time.)																																																
Light Source	1 Integrated High Output Nichia® LED, tightly binned for color uniformity, and constant current driver	3 Integrated High Output Nichia® LEDs, tightly binned for color uniformity, and constant current driver																																																
Beam Spread	55°	55°																																																
Color Temp. (CCT) & CRI	3000K (-200/+125) / 80s CRI	3000K (-200/+125) / 80s CRI																																																
Power Usage at 12V AC Input VA and Watts	0.19 W, 0.28 VA Multiply fixture VA by the number of fixtures used to determine size of transformer	.75 W, 1.3 VA Multiply fixture VA by the number of fixtures used to determine size of transformer																																																
Operating Voltage Range	9V-15V AC/DC with no loss in output due to constant current technology	9V-15V AC/DC with no loss in output due to constant current technology																																																
Lumen Main.	Tested to an L-70 of 40,000 hours	Tested to an L-70 of 40,000 hours																																																
Total Lumens & Efficacy	3000K = 8.6 Lm 3000K = 45 Lm/W	3000K = 44.5 Lm 3000K = 59 Lm/W																																																
Wiring	70" of usable #18-2, SPT-1W leads. Pro series wire connectors supplied	70" of usable #18-2, SPT-1W leads. Pro series wire connectors supplied																																																
Mounting Acces.	Stainless steel mounting screws	Stainless steel masonry bracket and mounting screws																																																
Optional Acces.	15716 SS - 1 LED Accessory Bracket	15717 SS - 3 LED Accessory Bracket																																																
Notes	Subjected to Highly Accelerated Life Testing - 3rd party reliability testing Not for use with electronic transformers	Subjected to Highly Accelerated Life Testing - 3rd party reliability testing Not for use with electronic transformers																																																
Fixture Photometric (fc)	<table border="1"> <thead> <tr> <th>Mounting Height</th> <th>0'</th> <th>1'</th> <th>2'</th> <th>3'</th> <th>4'</th> </tr> </thead> <tbody> <tr> <td>foot candles at 12"</td> <td>8.65</td> <td>1.10</td> <td>0.07</td> <td>0.03</td> <td>0.02</td> </tr> <tr> <td>foot candles at 24"</td> <td>2.08</td> <td>0.98</td> <td>0.30</td> <td>0.06</td> <td>0.04</td> </tr> <tr> <td>foot candles at 36"</td> <td>0.95</td> <td>0.61</td> <td>0.30</td> <td>0.14</td> <td>0.06</td> </tr> </tbody> </table>	Mounting Height	0'	1'	2'	3'	4'	foot candles at 12"	8.65	1.10	0.07	0.03	0.02	foot candles at 24"	2.08	0.98	0.30	0.06	0.04	foot candles at 36"	0.95	0.61	0.30	0.14	0.06	<table border="1"> <thead> <tr> <th>Mounting Height</th> <th>0'</th> <th>1'</th> <th>2'</th> <th>3'</th> <th>4'</th> </tr> </thead> <tbody> <tr> <td>foot candles at 12"</td> <td>43.7</td> <td>4.89</td> <td>0.31</td> <td>0.12</td> <td>0.07</td> </tr> <tr> <td>foot candles at 24"</td> <td>10.7</td> <td>4.87</td> <td>1.29</td> <td>0.12</td> <td>0.08</td> </tr> <tr> <td>foot candles at 36"</td> <td>4.96</td> <td>3.14</td> <td>1.56</td> <td>0.67</td> <td>0.24</td> </tr> </tbody> </table>	Mounting Height	0'	1'	2'	3'	4'	foot candles at 12"	43.7	4.89	0.31	0.12	0.07	foot candles at 24"	10.7	4.87	1.29	0.12	0.08	foot candles at 36"	4.96	3.14	1.56	0.67	0.24
Mounting Height	0'	1'	2'	3'	4'																																													
foot candles at 12"	8.65	1.10	0.07	0.03	0.02																																													
foot candles at 24"	2.08	0.98	0.30	0.06	0.04																																													
foot candles at 36"	0.95	0.61	0.30	0.14	0.06																																													
Mounting Height	0'	1'	2'	3'	4'																																													
foot candles at 12"	43.7	4.89	0.31	0.12	0.07																																													
foot candles at 24"	10.7	4.87	1.29	0.12	0.08																																													
foot candles at 36"	4.96	3.14	1.56	0.67	0.24																																													

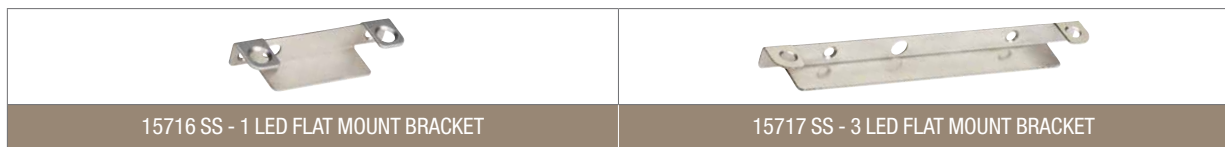

	15716 SS - 1 LED FLAT MOUNT BRACKET	15717 SS - 3 LED FLAT MOUNT BRACKET
Fits	Fits 15734, 15744 (1 LED)	Fits 15735, 15745 (3 LED)
Dimensions	Width - .66", Length - 3.0", Height - .60"	Width - .66", Length - 6.9", Height - .60"
Finish	Stainless Steel	Stainless Steel
Notes	Mounting hardware included. U.S. Patent Pending.	Mounting hardware included. U.S. Patent Pending.

DESIGN PRO LED 12V HARDSCAPE, DECK, STEP AND BENCH

POWERED BY
DESIGN PRO LED
TECHNOLOGY

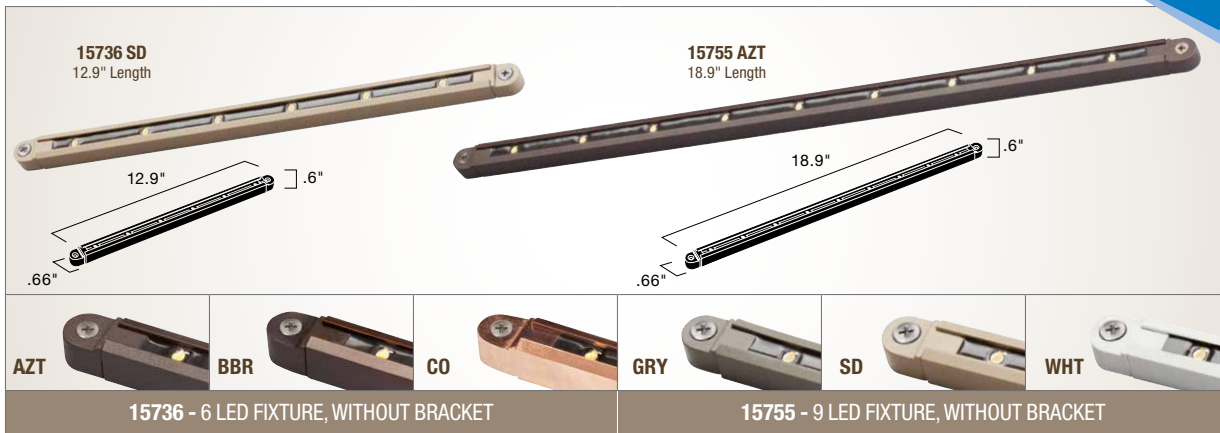

	15736 - 6 LED FIXTURE, WITHOUT BRACKET	15755 - 9 LED FIXTURE, WITHOUT BRACKET																																																
Ordering Guide & Finish	15736 AZT30 - Textured Architectural Bronze (Marine grade powder coat) 15736 BBR30 - Bronzed Brass 15736 CO30 - Unfinished Copper 15736 GRY30 - Textured Gray (Marine grade powder coat) 15736 SD30 - Textured Sand (Marine grade powder coat) 15736 WHT30 - Textured White (Marine grade powder coat)	15755 AZT30 - Textured Architectural Bronze (Marine grade powder coat) 15755 BBR30 - Bronzed Brass 15755 CO30 - Unfinished Copper 15755 GRY30 - Textured Gray (Marine grade powder coat) 15755 SD30 - Textured Sand (Marine grade powder coat) 15755 WHT30 - Textured White (Marine grade powder coat)																																																
Housing	Aluminum, Brass, Copper Plated Brass (Copper will naturally patina over time).	Aluminum, Brass, Copper Plated Brass (Copper will naturally patina over time).																																																
Light Source	6 Integrated High Output Nichia® LEDs, tightly binned for color uniformity, and constant current driver	9 Integrated High Output Nichia® LEDs, tightly binned for color uniformity, and constant current driver																																																
Beam Spread	55°	55°																																																
Color Temp. (CCT) & CRI	3000K (-200/+125) / 80s CRI	3000K (-200/+125) / 80s CRI																																																
Power Usage at 12V AC Input VA and Watts	1.4 W, 2.4 VA Multiply fixture VA by the number of fixtures used to determine size of transformer	2.2 W, 3.7 VA Multiply fixture VA by the number of fixtures used to determine size of transformer																																																
Operating Voltage Range	9V-15V AC/DC with no loss in output due to constant current technology	9V-15V AC/DC with no loss in output due to constant current technology																																																
Lumen Main.	Tested to an L-70 of 40,000 hours	Tested to an L-70 of 40,000 hours																																																
Total Lumens & Efficacy	3000K = 88 Lm 3000K = 61 Lm/W	3000K = 132 Lm 3000K = 62 Lm/W																																																
Wiring	70" of usable #18-2, SPT-1W leads. Pro series wire connectors supplied	70" of usable #18-2, SPT-1W leads. Pro series wire connectors supplied																																																
Mounting Acces.	Stainless steel masonry bracket and mounting screws	Stainless steel masonry bracket and mounting screws																																																
Optional Acces.	15718 SS - 6 LED Accessory Bracket	15719 SS - 9 LED Accessory Bracket																																																
Notes	Subjected to Highly Accelerated Life Testing - 3rd party reliability testing Not for use with electronic transformers	Subjected to Highly Accelerated Life Testing - 3rd party reliability testing Not for use with electronic transformers																																																
Fixture Photometric (fc)	<table border="1"> <thead> <tr> <th>Mounting Height</th> <th>0'</th> <th>1'</th> <th>2'</th> <th>3'</th> <th>4'</th> </tr> </thead> <tbody> <tr> <td>foot candles at 12"</td> <td>65.10</td> <td>9.74</td> <td>0.60</td> <td>0.22</td> <td>0.14</td> </tr> <tr> <td>foot candles at 24"</td> <td>19.64</td> <td>9.15</td> <td>2.72</td> <td>0.48</td> <td>0.24</td> </tr> <tr> <td>foot candles at 36"</td> <td>9.16</td> <td>5.82</td> <td>2.74</td> <td>1.00</td> <td>0.30</td> </tr> </tbody> </table>	Mounting Height	0'	1'	2'	3'	4'	foot candles at 12"	65.10	9.74	0.60	0.22	0.14	foot candles at 24"	19.64	9.15	2.72	0.48	0.24	foot candles at 36"	9.16	5.82	2.74	1.00	0.30	<table border="1"> <thead> <tr> <th>Mounting Height</th> <th>0'</th> <th>1'</th> <th>2'</th> <th>3'</th> <th>4'</th> </tr> </thead> <tbody> <tr> <td>foot candles at 12"</td> <td>80.40</td> <td>12.00</td> <td>1.08</td> <td>0.36</td> <td>0.21</td> </tr> <tr> <td>foot candles at 24"</td> <td>26.81</td> <td>13.13</td> <td>3.81</td> <td>0.91</td> <td>0.39</td> </tr> <tr> <td>foot candles at 36"</td> <td>13.51</td> <td>8.43</td> <td>4.55</td> <td>1.78</td> <td>0.62</td> </tr> </tbody> </table>	Mounting Height	0'	1'	2'	3'	4'	foot candles at 12"	80.40	12.00	1.08	0.36	0.21	foot candles at 24"	26.81	13.13	3.81	0.91	0.39	foot candles at 36"	13.51	8.43	4.55	1.78	0.62
Mounting Height	0'	1'	2'	3'	4'																																													
foot candles at 12"	65.10	9.74	0.60	0.22	0.14																																													
foot candles at 24"	19.64	9.15	2.72	0.48	0.24																																													
foot candles at 36"	9.16	5.82	2.74	1.00	0.30																																													
Mounting Height	0'	1'	2'	3'	4'																																													
foot candles at 12"	80.40	12.00	1.08	0.36	0.21																																													
foot candles at 24"	26.81	13.13	3.81	0.91	0.39																																													
foot candles at 36"	13.51	8.43	4.55	1.78	0.62																																													



	15718 SS - 6 LED FLAT MOUNT BRACKET	15719 SS - 9 LED FLAT MOUNT BRACKET
Fits	Fits 15736, 15746 (6 LED)	Fits 15755, 15756 (9 LED)
Dimensions	Width - .66", Length - 12.9", Height - .60"	Width - .66", Length - 18.9", Height - .60"
Finish	Stainless Steel	Stainless Steel
Notes	Mounting hardware included. U.S. Patent Pending.	Mounting hardware included. U.S. Patent Pending.

DESIGN PRO LED 12V HARDSCAPE

D

TaskWork LED 24V DC Outdoor Wet Tape Light



Low Profile, High Efficiency

- Ultra thin profile (.5"W, .2" H) which yields 200 Lumens per foot (high output)
- Available in black and white finishes

Long Life, Low Energy Usage

- 50,000 hour life while using 4 Watts per foot (high output)
- UL outdoor wet location rated

Easy to Install

- Highly customizable, flexible and cuttable design
- 3M brand adhesive backing
- Plug and play operation

Beautiful Color

- Kelvin temperature range from 3200K (pure white) or 3600K (cool white)
- Color Rendering Index (CRI) of 80
- Dimming capabilities
- Available in single colors: white, red, blue, yellow or green; and color changing RGB



Outdoor Wet Tape is available in 3200K (pure white) & 3600K (cool white).



Outdoor Wet Tape is also available in Red, Green, Yellow, Blue and Color Changing RGB.



To learn more about TaskWork LED Tape Light, scan with your smart phone.





KICHLER®



Medium Accent Fixture
(Shown in BBR) available
in 12V (6.5W & 13W) & 120V
(12.5W) versions



Large Accent Fixture
(Shown in AZT) available
in 12V (21W) & 120V (19.5W
& 29W) versions

LED 12V Accent & In-Ground, 120V Accent

Discover the most technologically evolved lighting fixtures available in the landscape lighting industry.

We've engineered our exclusive **Radiax™ optics** to generate **more lumens with less wattage** for **superior results**. We've also expanded your options for design with **multiple Kelvin temperatures** and **lumen output choices**. And, we've integrated it all into a unit that's **sealed and fully potted to protect it from the elements**. Then, we backed it up with a 10 year commercial and 15-year residential warranty*. Our latest Design Pro LED 12V accent or in-ground options, as well as our 120V accent products, deliver versatility that gives every **residential** and **commercial** job a **more professional look**.

*For warranty, go to landscapelighting.com

More Lumen
Output Choices
+

More Kelvin
Temperature
Options
+

More Lumens
Per Watt
=

**Superior
Light
Fixtures**

POWERED BY
DESIGN PRO LED
TECHNOLOGY
WITH
Radiax™
OPTICS



Small Accent Fixture
(Shown in WHT)
available in 12V (3W
& 4W) version only



In-Ground Fixture
(Cast Brass) available
in 12V (4W, 6.5W &
14W) version only

Design Pro LED with Radiax™ Optics Offers Multiple Kelvin Temperature Options



WARM WHITE
2700K



PURE WHITE
3000K



COOL WHITE
4250K

POWERED BY
DESIGN PRO LED
TECHNOLOGY

Radiax™ optics come in two forms – side-powered on larger fixtures, and center-powered on smaller ones. Both designs give Kichler® fixtures the greatest lumens per watt over comparable fixtures.

WITH
Radiax™
OPTICS

Side-Powered Radiax



Center-Powered Radiax



Precise, powerful & efficient landscape lighting

Design Pro LED with Radiax Optics: Superior LED Light Fixtures, Superior Results

Wattage equals energy used – and in the old days, it also equated to how bright a light looked. Today, we know that lumens are a better indication of a light's brightness, and at Kichler we've engineered a solution to get the **most lumens with the least amount of wattage**. Our **Radiax optics**, a Kichler exclusive design, **drive increased output** from our LED chips, creating a **more focused and uniform** light at a **cooler operating temperature**. Plus, the Radiax high performance LED optics are engineered **specifically for landscape lighting use**. In addition, a range of Kelvin temperature options gives you the **precise light effects** you need on every job.

Superior Light Fixtures, Superior Results



Design Pro LED fixture
120V, 12.5 Watt

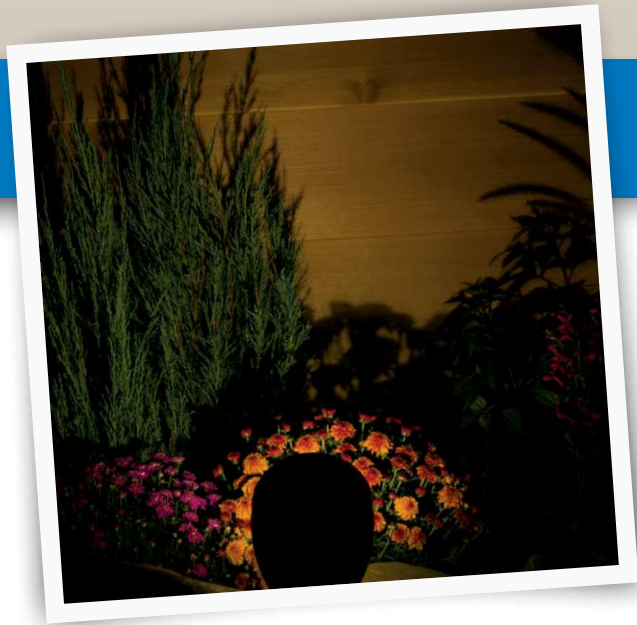

Competitor LED fixture
120V, 13 Watt

TOTAL ANNUAL COST COMPARISON*

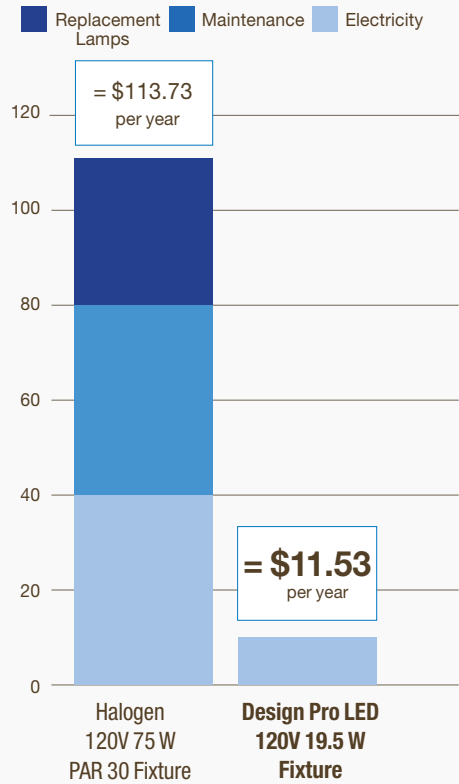

Our **Radiax™ optics**, with optimized thermal management, not only **drive increased output** from our LED chips, but also help to **melt snow** from around the fixtures.



FEATURES

- Five lumen output options for just the right punch of light.
- Three beam spread options, 10°, 35° or 60°, put light where you want it.
- A range of Kelvin color temperature choices from warm white 2700K to pure white 3000K.
- Radiax™ optics deliver the greatest lumens per watt in the industry.
- Tight LED binning tolerances mean greater color consistency.
- Built-in adjustable cowl provides better glare control.
- 9V-15V operating range virtually eliminates voltage drop.

LED 12V Accent

With a variety of lumen output options you can install the intensity of light that best suits the environment – while still getting tremendous energy savings thanks to our Radiax Optics. Plus, our beam spread options assure more precise light distribution and beam control than the competition. Add accessory lenses specifically designed for Kichler® LED – amber, green or frosted – to create a more customized look.

Easy to install
optional LED
lenses



Superior 12V Light Fixtures, Superior Results



Design Pro LED Accent
12V, 6.5W Flood



Competitor LED Accent
12V, 15W Flood

DESIGN PRO LED 12V ACCENT



16000, 16001, 16002- 12V 3W LED ACCENT

Description	A specification-grade LED fixture collection that features more lumen output packages, Kelvin options and unparalleled performance.
Ordering Guide & Finish	Textured Architectural Bronze (Marine grade powder coat) Beach (Marine grade powder coat) Bronzed Brass Textured Black (Marine grade powder coat) Textured White (Marine grade powder coat)
Housing	Cast Aluminum, Cast Brass (brass will naturally patina over time)
Light Source	1 Integrated High Output Cree® LED, tightly binned for color uniformity, and constant current driver
Color Temp. (CCT) & CRI	2700K (-50/+100) Warm White 3000K (-45/+130) Pure White / 80s CRI
Optics	Radiax™
Power Usage at 12V AC Input VA and Watts	3W, 4VA Multiply fixture VA by the number of fixtures used to determine size of transformer
Operating Voltage Range	9V-15V AC/DC with no loss in output due to constant current technology
Lumen Maint.	Tested to an L-70 of 40,000 hours
Total Lumens & Efficacy	2700K = 109 Lm 3000K = 116 Lm 2700K = 36 Lm/W 3000K = 39 Lm/W
Wiring	24" of usable #18-2, SPT-1W leads. Pro series wire connectors supplied
Mounting Acces. Included	8" in-ground stake
Optional Acces.	15601 - Surface Mounting Flange 15607 - Surface Bracket 15609 - Junction Box Mounting Bracket 15647 - 90° Elbow
Notes	Subjected to Highly Accelerated Life Testing - 3rd party reliability testing Textured white only available in 35° beam Not for use with electronic transformers *Cree is a registered trademark of Cree, Inc.

ORDER GUIDE



Kelvin	2700K WARM WHITE	3000K PURE WHITE
Watts/Lumens	Compares to Halogen 10W MR16	
Beam Spread 10° Spot	16000 AZT27 16000 BBR27 16000 BKT27 16000 BE27	16000 AZT30 16000 BBR30 16000 BKT30 16000 BE30
Beam Spread 35° Flood	16001 AZT27 16001 BBR27 16001 BKT27 16001 BE27 16001 WHT27	16001 AZT30 16001 BBR30 16001 BKT30 16001 BE30 16001 WHT30
Beam Spread 60° Wide Flood	16002 AZT27 16002 BBR27 16002 BKT27 16002 BE27	16002 AZT30 16002 BBR30 16002 BKT30 16002 BE30

FINISH GUIDE

- AZT** – Textured Architectural Bronze
- BBR** – Bronzed Brass
- BKT** – Textured Black
- BE** – Beach
- WHT** – Textured White

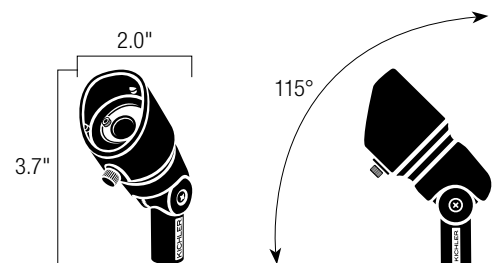

DESIGN PRO LED 12V ACCENT



Description	A specification-grade LED fixture collection that features more lumen output packages, Kelvin options and unparalleled performance
Ordering Guide & Finish	Textured Architectural Bronze (Marine grade powder coat) Beach (Marine grade powder coat) Bronzed Brass Textured Black (Marine grade powder coat) Textured White (Marine grade powder coat)
Housing	Cast Aluminum, Cast Brass (brass will naturally patina over time)
Light Source	1 Integrated High Output Cree® LED, tightly binned for color uniformity, and constant current driver
Color Temp. (CCT) & CRI	2700K (-50/+100) Warm White 3000K (-45/+130) Pure White / 80s CRI
Optics	Radiax™
Power Usage at 12V AC Input VA and Watts	4W, 5.5VA Multiply fixture VA by the number of fixtures used to determine size of transformer
Operating Voltage Range	9V-15V AC/DC with no loss in output due to constant current technology
Lumen Maint.	Tested to an L-70 of 40,000 hours
Total Lumens & Efficacy	2700K = 151 Lm 3000K= 180 Lm 2700K = 38 Lm/W 3000K = 45 Lm/W
Wiring	24" of usable #18-2, SPT-1W leads. Pro series wire connectors supplied
Mounting Acces. Included	8" in-ground stake
Optional Acces.	15601 - Surface Mounting Flange 15607 - Surface Bracket 15609 - Junction Box Mounting Bracket 15647 - 90° Elbow
Notes	Subjected to Highly Accelerated Life Testing – 3rd party reliability testing Textured White only available in 35° beam. Not for use with electronic transformers. *Cree is a registered trademark of Cree, Inc.

ORDER GUIDE



Kelvin	2700K WARM WHITE	3000K PURE WHITE
Watts/Lumens	Compares to Halogen 20W MR16	
Beam Spread 10° Spot	16003 AZT27 16003 BBR27 16003 BKT27 16003 BE27	16003 AZT30 16003 BBR30 16003 BKT30 16003 BE30
Beam Spread 35° Flood	16004 AZT27 16004 BBR27 16004 BKT27 16004 BE27 16004 WHT27	16004 AZT30 16004 BBR30 16004 BKT30 16004 BE30 16004 WHT30
Beam Spread 60° Wide Flood	16005 AZT27 16005 BBR27 16005 BKT27 16005 BE27	16005 AZT30 16005 BBR30 16005 BKT30 16005 BE30

FINISH GUIDE

AZT	Textured Architectural Bronze
BBR	Bronzed Brass
BKT	Textured Black
BE	Beach
WHT	Textured White

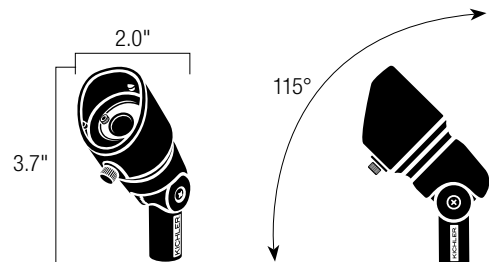

DESIGN PRO LED 12V ACCENT



16006, 16007, 16008- 12V 6.5W LED ACCENT

Description	A specification-grade LED fixture collection that features more lumen output packages, Kelvin options and unparalleled performance.
Ordering Guide & Finish	Textured Architectural Bronze (Marine grade powder coat) Beach (Marine grade powder coat) Bronzed Brass Textured Black (Marine grade powder coat) Textured White (Marine grade powder coat)
Housing	Cast Aluminum, Cast Brass (brass will naturally patina over time)
Light Source	5 Integrated High Output Cree® LEDs, tightly binned for color uniformity, and constant current driver
Color Temp. (CCT) & CRI	2700K (-50/+100) Warm White 3000K (-45/+130) Pure White / 80s CRI
Optics	Radiax™
Power Usage at 12V AC Input VA and Watts	6.5W, 10.0VA Multiply fixture VA by the number of fixtures used to determine size of transformer
Operating Voltage Range	9V-15V AC/DC with no loss in output due to constant current technology
Lumen Maint.	Tested to an L-70 of 40,000 hours
Total Lumens & Efficacy	2700K = 306 Lm 3000K= 352 Lm 2700K = 47 Lm/W 3000K = 54 Lm/W
Wiring	24" of usable #18-2, SPT-1W leads. Pro series wire connectors supplied
Mounting Acces. Included	8" in-ground stake
Optional Acces.	15601 – Surface Mounting Flange 15607 – Surface Bracket 15609 – Junction Box Mounting Bracket 15647 – 90° Elbow
Notes	Subjected to Highly Accelerated Life Testing – 3rd party reliability testing Textured White only available in 35° beam. Not for use with electronic transformers. *Cree is a registered trademark of Cree, Inc.

ORDER GUIDE



Kelvin	2700K WARM WHITE	3000K PURE WHITE
Watts/Lumens	Compares to Halogen 35W MR16	
Beam Spread 10° Spot	16006 AZT27 16006 BBR27 16006 BKT27 16006 BE27	16006 AZT30 16006 BBR30 16006 BKT30 16006 BE30
Beam Spread 35° Flood	16007 AZT27 16007 BBR27 16007 BKT27 16007 BE27 16007 WHT27	16007 AZT30 16007 BBR30 16007 BKT30 16007 BE30 16007 WHT30
Beam Spread 60° Wide Flood	16008 AZT27 16008 BBR27 16008 BKT27 16008 BE27	16008 AZT30 16008 BBR30 16008 BKT30 16008 BE30

FINISH GUIDE

- AZT** – Textured Architectural Bronze
- BBR** – Bronzed Brass
- BKT** – Textured Black
- BE** – Beach
- WHT** – Textured White

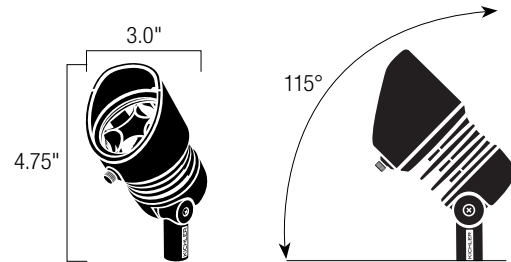

DESIGN PRO LED 12V ACCENT



16009, 16010, 16011- 12V 13W LED ACCENT

Description	A specification-grade LED fixture collection that features more lumen output packages, Kelvin options and unparalleled performance.
Ordering Guide & Finish	Textured Architectural Bronze (Marine grade powder coat) Beach (Marine grade powder coat) Bronzed Brass Textured Black (Marine grade powder coat) Textured White (Marine grade powder coat)
Housing	Cast Aluminum, Cast Brass (brass will naturally patina over time)
Light Source	5 Integrated High Output Cree® LEDs, tightly binned for color uniformity, and constant current driver
Color Temp. (CCT) & CRI	2700K (-50/+100) Warm White 3000K (-45/+130) Pure White / 80s CRI
Optics	Radiax™
Power Usage at 12V AC Input VA and Watts	13W, 8.5VA Multiply fixture VA by the number of fixtures used to determine size of transformer
Operating Voltage Range	9V-15V AC/DC with no loss in output due to constant current technology
Lumen Maint.	Tested to an L-70 of 40,000 hours
Total Lumens & Efficacy	2700K = 520 Lm 3000K = 590 Lm 2700K = 40 Lm/W 3000K = 45 Lm/W
Wiring	24" of usable #18-2, SPT-1W leads. Pro series wire connectors supplied
Mounting Acces. Included	8" in-ground stake
Optional Acces.	15601 - Surface Mounting Flange 15607 - Surface Bracket 15609 - Junction Box Mounting Bracket 15647 - 90° Elbow
Notes	Subjected to Highly Accelerated Life Testing – 3rd party reliability testing Textured White only available in 35° beam. Not for use with electronic transformers. *Cree is a registered trademark of Cree, Inc.

ORDER GUIDE



Kelvin	2700K WARM WHITE	3000K PURE WHITE
Watts/Lumens	Compares to Halogen 50W MR16	
Beam Spread 10° Spot	16009 AZT27 16009 BBR27 16009 BKT27 16009 BE27	16009 AZT30 16009 BBR30 16009 BKT30 16009 BE30
Beam Spread 35° Flood	16010 AZT27 16010 BBR27 16010 BKT27 16010 BE27 16010 WHT27	16010 AZT30 16010 BBR30 16010 BKT30 16010 BE30 16010 WHT30
Beam Spread 60° Wide Flood	16011 AZT27 16011 BBR27 16011 BKT27 16011 BE27	16011 AZT30 16011 BBR30 16011 BKT30 16011 BE30

FINISH GUIDE

AZT – Textured Architectural Bronze
BBR – Bronzed Brass
BKT – Textured Black
BE – Beach
WHT – Textured White

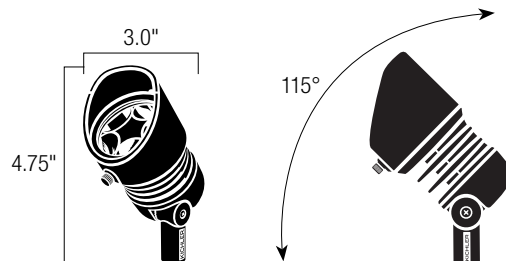

DESIGN PRO LED 12V ACCENT



16012, 16013, 16014- 12V 21W LED ACCENT

Description	A specification-grade LED fixture collection that features more lumen output packages, Kelvin options and unparalleled performance.
Ordering Guide & Finish	Textured Architectural Bronze (Marine grade powder coat) Beach (Marine grade powder coat) Bronzed Brass Textured Black (Marine grade powder coat) Textured White (Marine grade powder coat)
Housing	Cast Aluminum, Cast Brass (brass will naturally patina over time)
Light Source	8 Integrated High Output Cree® LEDs, tightly binned for color uniformity, and constant current driver
Color Temp. (CCT) & CRI	2700K (-50/+100) Warm White 3000K (-45/+130) Pure White / 80s CRI
Optics	Radiax™
Power Usage at 12V AC Input VA and Watts	21W, 27.0VA Multiply fixture VA by the number of fixtures used to determine size of transformer
Operating Voltage Range	9V-15V AC/DC with no loss in output due to constant current technology
Lumen Maint.	Tested to an L-70 of 40,000 hours
Total Lumens & Efficacy	2700K = 947 Lm 3000K= 993 Lm 2700K = 45 Lm/W 3000K = 47 Lm/W
Wiring	24" of usable #18-2, SPT-1W leads. Pro series wire connectors supplied
Mounting Acces. Included	8" in-ground stake
Optional Acces.	15601 - Surface Mounting Flange 15607 - Surface Bracket 15609 - Junction Box Mounting Bracket 15647 - 90° Elbow
Notes	Subjected to Highly Accelerated Life Testing – 3rd party reliability testing Textured White only available in 35° beam. Not for use with electronic transformers. *Cree is a registered trademark of Cree, Inc.

ORDER GUIDE



Kelvin	2700K WARM WHITE	3000K PURE WHITE
Watts/Lumens	Compares to Halogen 75W MR16	
Beam Spread 10° Spot	16012 AZT27 16012 BBR27 16012 BKT27 16012 BE27	16012 AZT30 16012 BBR30 16012 BKT30 16012 BE30
Beam Spread 35° Flood	16013 AZT27 16013 BBR27 16013 BKT27 16013 BE27 16013 WHT27	16013 AZT30 16013 BBR30 16013 BKT30 16013 BE30 16013 WHT30
Beam Spread 60° Wide Flood	16014 AZT27 16014 BBR27 16014 BKT27 16014 BE27	16014 AZT30 16014 BBR30 16014 BKT30 16014 BE30

FINISH GUIDE

- AZT** – Textured Architectural Bronze
- BBR** – Bronzed Brass
- BKT** – Textured Black
- BE** – Beach
- WHT** – Textured White

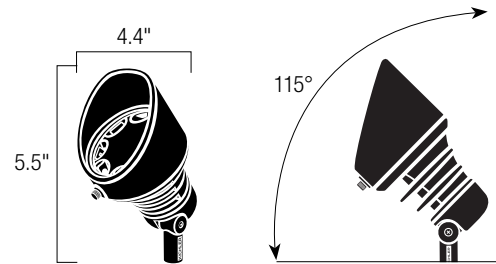



FEATURES

- Three lumen output options for just the right punch of light.
- Three beam spread options, 10°, 35° or 60°, put light where you want it.
- A range of Kelvin color temperature choices from pure white 3000K to cool white 4250K.
- Radiax™ Optics deliver the greatest lumens per watt in the industry for comparable fixtures.
- Constructed from durable, specification grade materials.

LED 120V Accent

In the commercial world, ROI counts – and you can count on our 120V fixtures to pay for themselves on average in less than two years with lower cost of ownership. Plus, our Radiax Optics deliver more efficient lumens per watt, for energy savings that help the bottom line. There's no better solution for replacing your halogen PAR and metal halide lamps.

75W Halogen

= \$113.73
per year

19.5W Design Pro LED

= \$11.53
per year

Superior Light Fixtures, Superior Results



Design Pro LED fixture
120V, 12.5 Watt



Competitor LED Fixture
120V, 13 Watt

DESIGN PRO LED 120V ACCENT



16200, 16201, 16206 - 120V 12.5W LED ACCENT

Description	A specification-grade LED fixture collection for both new installations and existing fixture replacement.
Ordering Guide & Finish	Textured Architectural Bronze (marine grade powder coat) Bronzed Brass Textured White (marine grade powder coat)
Housing	Cast Aluminum, Cast Brass (brass will naturally patina over time)
Light Source	5 Integrated High Output Cree® LEDs, tightly binned for color uniformity
Color Temp. (CCT) & CRI	3000K (-45/+130) Pure White, 4250K (-250/+250) Cool White 3000K = 80s, 4250K = 85 minimum
Optics	Radiax™
Power Usage	12.5W, .13VA, .85pf
Operating Voltage Range	108-132V AC, 50-60 Hz with no loss in output due to constant current technology
Lumen Maint.	Tested to an L-70 of 40,000 hours
Total Lumens & Efficacy	3000K = 590 Lm 4250K = 646 Lm 3000K = 47 Lm/W 4250K = 52 Lm/W
Wiring	8" of usable 200° C 18AWG wire leads
Mounting Acces.	N/A
Optional Acces.	15276 - Power Post® 15601 - Surface Mounting Flange, for attachment to junction box 15609 - Junction Box Mounting Bracket
Notes	Subjected to Highly Accelerated Life Testing – 3rd party reliability testing *Cree is a registered trademark of Cree, Inc.

ORDER GUIDE



Kelvin	3000K PURE WHITE	4250K COOL WHITE
Watts/Lumens	Compares to Halogen 50W PAR30	
Beam Spread 10° Spot	16200 AZT30 16200 BBR30 16200 WHT30	16200 AZT42 16200 BBR42 16200 WHT42
Beam Spread 35° Flood	16201 AZT30 16201 BBR30 16201 WHT30	16201 AZT42 16201 BBR42 16201 WHT42
Beam Spread 60° Wide Flood	16206 AZT30 16206 BBR30 16206 WHT30	16206 AZT42 16206 BBR42 16206 WHT42

FINISH GUIDE

- AZT – Textured Architectural Bronze
- BBR – Bronzed Brass
- WHT – Textured White

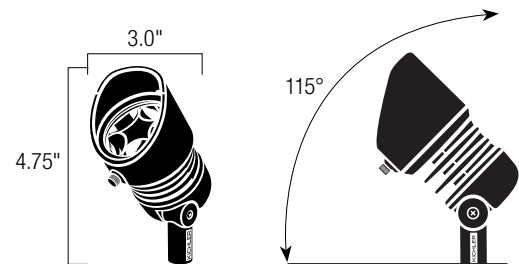

DESIGN PRO LED 120V ACCENT



16202, 16203, 16207 - 120V 19.5W LED ACCENT

Description	A specification-grade LED fixture collection for both new installations and existing fixture replacement.
Ordering Guide & Finish	Textured Architectural Bronze (marine grade powder coat) Bronzed Brass, Textured White (marine grade powder coat)
Housing	Cast Aluminum, Cast Brass (brass will naturally patina over time)
Light Source	8 Integrated High Output Cree® LEDs, tightly binned for color uniformity
Color Temp. (CCT) & CRI	3000K (-45/+130) Pure White, 4250K (-250/+250) Cool White 3000K = 80s, 4250K = 85 minimum
Optics	Radiax™
Power Usage	19.5W, .18A, .90pf
Operating Voltage Range	108-132V AC, 50-60 Hz with no loss in output due to constant current technology
Lumen Maint.	Tested to an L-70 of 40,000 hours
Total Lumens & Efficacy	3000K = 947 Lm 4250K = 993 Lm 3000K = 49 Lm/W 4250K = 51 Lm/W
Wiring	8" of usable 200° C 18AWG wire leads
Mounting Acces.	N/A
Optional Acces.	15276 - Power Post® 15601 - Surface Mounting Flange, for attachment to junction box 15609 - Junction Box Mounting Bracket
Notes	Subjected to Highly Accelerated Life Testing – 3rd party reliability testing *Cree is a registered trademark of Cree, Inc.

ORDER GUIDE



Kelvin	3000K PURE WHITE	4250K COOL WHITE
Watts/Lumens	Compares to Halogen 75W PAR30	
Beam Spread 10° Spot	16202 AZT30 16202 BBR30 16202 WHT30	16202 AZT42 16202 BBR42 16202 WHT42
Beam Spread 35° Flood	16203 AZT30 16203 BBR30 16203 WHT30	16203 AZT42 16203 BBR42 16203 WHT42
Beam Spread 60° Wide Flood	16207 AZT30 16207 BBR30 16207 WHT30	16207 AZT42 16207 BBR42 16207 WHT42

FINISH GUIDE

- AZT** – Textured Architectural Bronze
- BBR** – Bronzed Brass
- WHT** – Textured White

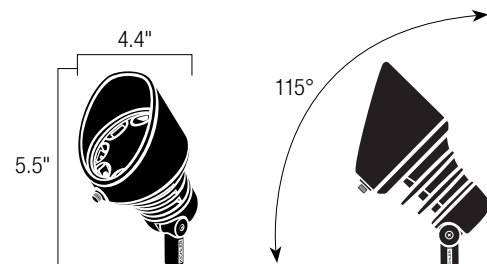

DESIGN PRO LED 120V ACCENT



16204, 16205, 16208 - 120V 29W LED ACCENT

Description	A specification-grade LED fixture collection for both new installations and existing fixture replacement.
Ordering Guide & Finish	Textured Architectural Bronze (marine grade powder coat) Bronzed Brass Textured White (marine grade powder coat)
Housing	Cast Aluminum, Cast Brass (brass will naturally patina over time)
Light Source	8 Integrated High Output Cree® LEDs, tightly binned for color uniformity
Color Temp. (CCT) & CRI	3000K (-45/+130) Pure White, 4250K (-250/+250) Cool White 3000K = 80s, 4250K = 85 minimum
Optics	Radiax™
Power Usage	29W, .27A, .90pf
Operating Voltage Range	108-132V AC, 50-60 Hz with no loss in output due to constant current technology
Lumen Maint.	Tested to an L-70 of 40,000 hours
Total Lumens & Efficacy	3000K = 1,131 Lm 4250K = 1,368 Lm 3000K = 39 Lm/W 4250K = 47 Lm/W
Wiring	8" of usable 200° C 18AWG wire leads
Mounting Acces.	N/A
Optional Acces.	15276 - Power Post® 15601 - Surface Mounting Flange, for attachment to junction box 15609 - Junction Box Mounting Bracket
Notes	Subjected to Highly Accelerated Life Testing – 3rd party reliability testing *Cree is a registered trademark of Cree, Inc.

ORDER GUIDE



Kelvin	3000K PURE WHITE	4250K COOL WHITE
Watts/Lumens	Compares to Halogen 100W PAR38	
Beam Spread 10° Spot	16204 AZT30 16204 BBR30 16204 WHT30	16204 AZT42 16204 BBR42 16204 WHT42
Beam Spread 35° Flood	16205 AZT30 16205 BBR30 16205 WHT30	16205 AZT42 16205 BBR42 16205 WHT42
Beam Spread 60° Wide Flood	16208 AZT30 16208 BBR30 16208 WHT30	16208 AZT42 16208 BBR42 16208 WHT42

FINISH GUIDE

- AZT – Textured Architectural Bronze
- BBR – Bronzed Brass
- WHT – Textured White

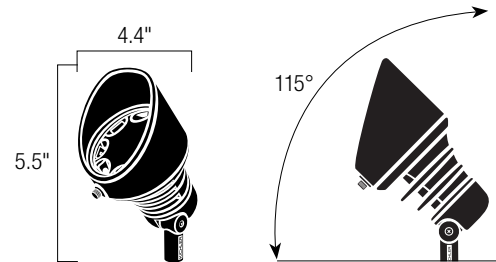

Install with Confidence

Integrated Design with Fully Encapsulated Electronics for Optimal All-Weather Performance

POWERED BY
DESIGN PRO LED
TECHNOLOGY

WITH
Radiax™
OPTICS

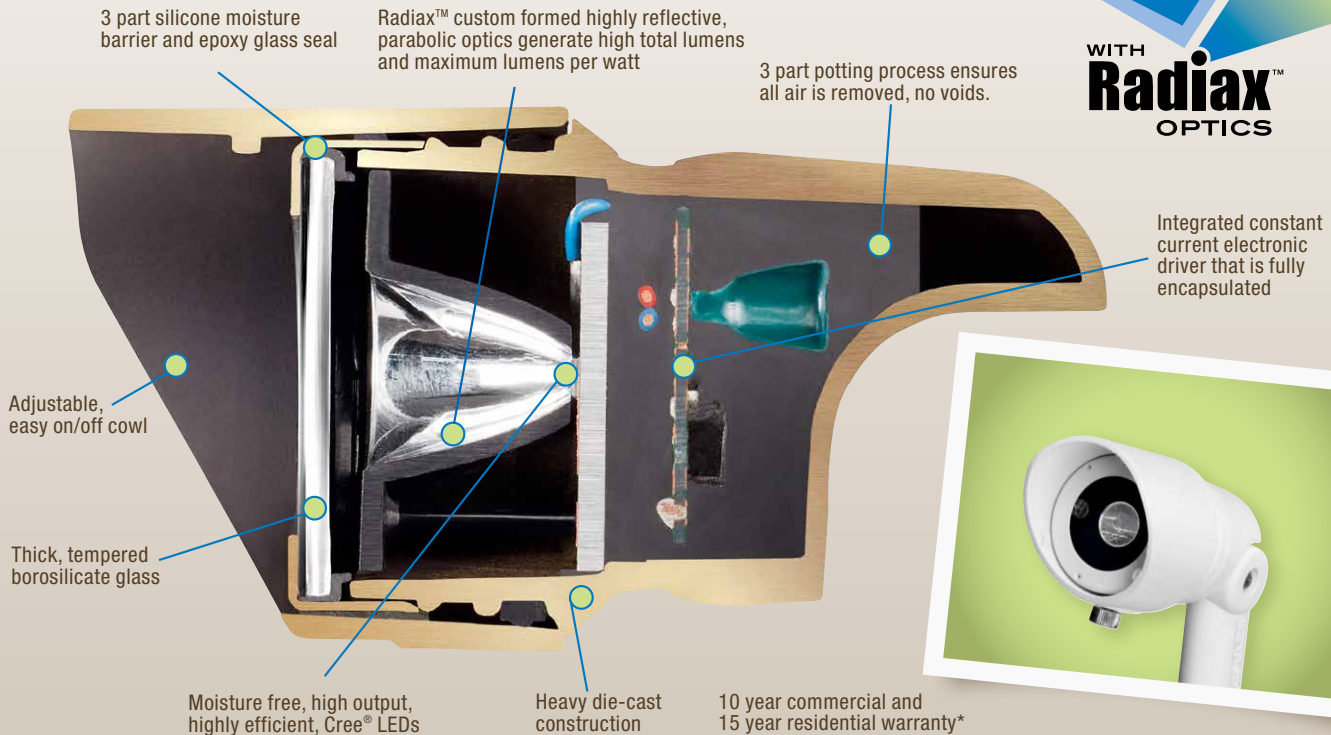

* For warranty details, go to landscapelighting.com

Then Customize for the Perfect Effect

For more accessory options, go to pages 146-153 and 186-189.





KICHLER®





KICHLER®



15731, 15732, 15733 AZT, BBR, BKT

15741, 15742, 15743 AZT, BBR, BKT

15751, 15752, 15753 AZT, BBR, BKT

Description	A full collection of accent lights engineered to provide the spread of light needed with the amount of lumen or light output desired.		
Ordering Guide & Finish	15731 - 10° Spot 15732 - Flood 15733 - 60° Wide Flood AZT - Textured Architectural Bronze (Marine grade powder coat) BBR - Bronzed Brass, BKT - Textured Black (Marine grade powder coat)	15741 - 10° Spot 15742 - Flood 15743 - 60° Wide Flood AZT - Textured Architectural Bronze (Marine grade powder coat) BBR - Bronzed Brass BKT - Textured Black (Marine grade powder coat)	15751 - 10° Spot 15752 - Flood 15753 - 60° Wide Flood AZT - Textured Architectural Bronze (Marine grade powder coat) BBR - Bronzed Brass BKT - Textured Black (Marine grade powder coat)
Housing	Cast Aluminum or Cast Brass with clear tempered glass lens and polycarbonate mounting stem and locknut.		
Light Source	3 Integrated High Output Nichia® LEDs, tightly binned for color uniformity, and constant current driver	6 Integrated High Output Nichia® LEDs, tightly binned for color uniformity, and constant current driver	9 Integrated High Output Nichia® LEDs, tightly binned for color uniformity, and constant current driver
Color Temp. (CCT) & CRI	3000K (-200/+125) / 80s CRI		
Optics	Custom T.I.R. (Total Internal Reflection) Acrylic Optics		
Power Usage at 12V AC Input VA and Watts	4.5 W, 7.5 VA Comparable to 20 W MR16. Multiply fixture VA by the number of fixtures used to determine size of transformer	8.5 W, 12.2 VA Comparable to 35 W MR16. Multiply fixture VA by the number of fixtures used to determine size of transformer	12.4 W, 16.7 VA Comparable to 50 W MR16. Multiply fixture VA by the number of fixtures used to determine size of transformer
Operating Voltage Range	9V-15V AC/DC with no loss in output due to constant current technology		
Lumen Maint.	Tested to an L-70 of 40,000 hours		
Total Lumens & Efficacy	3000K = 150 Lm 3000K = 33 Lm/W	3000K = 310 Lm 3000K = 36 Lm/W	3000K = 460 Lm 3000K = 37 Lm/W
Wiring	53" of usable #18-2, SPT-1-W leads. Cable connector supplied		
Mounting Acces. Included	8" in-ground stake		
Optional Acces.	15601 - Surface Mounting Flange 15647 - 90° Elbow	15609 - Junction Box Mounting Bracket 15607 - Surface Mounting Bracket	
Optional Cowl Acces.	15701 AZTP, BKTP Short Cowl for use with 4.5W and 8.5W size. 15703 AZTP, BKTP Long Cowl for use with 4.5W and 8.5W size.	15702 AZTP, BKTP Short Cowl for use with 12.4W size. 15704 AZTP, BKTP Long Cowl for use with 12.4W size.	For BBR fixture finishes, use AZTP.
Optional Lens Acces.	Amber - Offers warmer hues of light 15875 AMB For use with 4.5W/8.5W size 15876 AMB For use with 12.4W size	Green - Intensify the greens of foliage 15885 GRN For use with 4.5W/8.5W size 15886 GRN For use with 12.4W size	Frosted - Diffuse light where you need it 15895 FRO For use with 4.5W/8.5W size 15896 FRO For use with 12.4W size
Notes	See photometrics on pages 199. Subjected to Highly Accelerated Life Testing - 3rd party reliability testing. Not for use with electronic transformers		

DESIGN PRO LED 12V ACCENT



Cowls feature easy one step snap-on installation – glare shield rotates 360° in ring and retains its desired shield position.

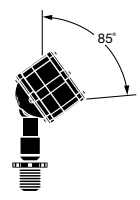

15647 BKT shown with 18" fixture mounting stem (15657 BKT) and LED Accent Light (15731 BKT), both sold separately.



Amber – Offer warmer hues of light
15875 AMB For use with 4.5W/8.5W size
15876 AMB For use with 12.4W size



Green – Intensify the greens of foliage
15885 GRN For use with 4.5W/8.5W size
15886 GRN For use with 12.4W size



Frosted – Diffuse light where you need it
15895 FRO For use with 4.5W/8.5W size
15896 FRO For use with 12.4W size

Lenses include replacement gasket, Allen wrench and extra ring screws. Colored lenses will slightly reduce light output.



DESIGN PRO LED 12V WALL WASH ACCENT



16070 AZT 27, 30, BBR 27, 30, BKT 27, 30- LED WALL WASH

Description	A rectangular aperture partnered with a horizontal array of LEDs creates a wide yet evenly distributed flood beam spread ideal for wall washing even when mounted a short distance away.								
Ordering Guide & Finish	16070 AZT27, 30 - Textured Architectural Bronze (Marine grade powder coat) 16070 BBR27, 30 - Bronzed Brass 16070 BKT27, 30 - Textured Black (Marine grade powder coat)								
Housing	Cast Aluminum, Cast Brass (brass will naturally patina over time)								
Light Source	3 Integrated High Output Nichia® LEDs, tightly binned for color uniformity, and constant current driver								
Beam Spread	Vertical = 80° Horizontal = 100°								
Color Temp. (CCT) & CRI	2700K (-60/ +100) 3000K (-50/+130) / 80s CRI								
Power Usage at 12V AC Input VA and Watts	4 W, 5.8 VA Multiply fixture VA by the number of fixtures used to determine size of transformer								
Operating Voltage Range	9V-15V AC/DC with no loss in output due to constant current technology								
Lumen Maint.	Tested to an L-70 of 40,000 hours								
Total Lumens & Efficacy	2700K = 109 Lm 25.2 Lm/W 3000K = 120 Lm 30 Lm/W								
Wiring	63" of usable #18-2, SPT-1W leads. Pro series wire connectors supplied								
Mounting Acces. Included	8" in-ground stake (included)								
Optional Acces.	15601 - Surface Mounting Flange 15607 - Surface Bracket 15609 - Junction Box Mounting Bracket 15647 - 90° Elbow								
Incandescent	15385 pg. 125								
Notes	Subjected to Highly Accelerated Life Testing - 3rd party reliability testing Not for use with electronic transformers								
Fixture Photometric (fc)	Distance from Wall	0'	6"	1'	2'	3'	4'	5'6"	(Horizontal Distance from Center)
	2"	22	16.8	6.7	3.0	1.0	0.5	.23	0.1
	4"	4.5	4.4	4	2.8	1.8	1.0	0.6	0.4



15861 AZT, BBR, BKT - LED WALL WASH ACCENT LIGHT

Understanding LED Lighting

Understanding Watts and VA (volts x amps)

Kichler® Landscape LED drivers convert the 12V AC current to a DC current specified by the LED chip manufacturer. When electric power is converted from AC to DC, there are losses and changes to the electrical properties; these effects are known as the "Power Factor".

In an LED lighting installation it is necessary to use the VA value of a fixture in order to compute and select a transformer with adequate power for the system. *For your convenience Kichler supplies the VA as well as the Wattage for each of the fixtures in our catalog.*

What does this mean to the system designer?

There are two areas to consider: the load on the transformer and Watts consumed according to the electric power company.

The load on the transformer

The "VA" (volts x amps) rating on Kichler Landscape products represents the value used when calculating the total system load. This VA number will help you determine the correct size transformer for an LED installation.

Example:

Number of Fixtures	x VA value	=	Transformer Load Requirement
(8) Fixtures	x 12.2VA ea.	=	97.8VA



15742

This LED system requires at least a 100 Watt transformer

The Watts consumed according to the power company

When determining the cost of ownership use the Watt rating of the LED fixture. This represents the actual electric consumption for which the homeowner will be billed.

Example:

Number of Fixtures	x Watts	=	Actual Electric Consumption
(8) Fixture	x 8.5 Watts ea.	=	68 Watts



15742

Description	Our Design Pro LED Wall Wash creates a low, even light spread that illuminates shrubs, plants and textured wall surfaces and silhouettes special details. Fully adjustable knuckle.																														
Ordering Guide & Finish	15861 AZT - Textured Architectural Bronze™ (Marine grade powder coat) 15861 BBR - Bronzed Brass 15861 BKT - Textured Black (Marine grade powder coat)																														
Housing	Cast Aluminum, Cast Brass																														
Light Source	3 Integrated High Output Nichia® LEDs, tightly binned for color uniformity, and constant current driver																														
Beam Spread	Vertical = 108° Horizontal = 111°																														
Color Temp. (CCT) & CRI	3000K (-200/+125) / 80s CRI																														
Power Usage at 12V AC Input VA and Watts	High 4 W, 5.8 VA Low 2.5 W, 4 VA Multiply fixture VA by the number of fixtures used to determine size of transformer																														
Operating Voltage Range	9V-15V AC/DC with no loss in output due to constant current technology																														
Lumen Maint.	Tested to an L-70 of 40,000 hours																														
Total Lumens & Efficacy	3000K = 140 Lm (High) 80 Lm (Low) 3000K = 35 Lm/W (High) 20 Lm/W (Low)																														
Wiring	64" of usable #18-2, SPT-1-W leads																														
Mounting Acces. Included	8" In-ground stake																														
Optional Acces.	15601 - Surface mounting flange 15607 - Surface mounting bracket 15647 - 90° Elbow																														
Fixture Photometric (fc) on High	<table border="1"> <thead> <tr> <th>Distance from Wall</th> <th>0'</th> <th>6"</th> <th>1'</th> <th>2'</th> <th>3'</th> <th>4'</th> <th>5'</th> <th>6'</th> <th>(Horizontal Distance from Center)</th> </tr> </thead> <tbody> <tr> <td>2"</td> <td>16.5</td> <td>12.3</td> <td>8.0</td> <td>2.6</td> <td>0.9</td> <td>0.2</td> <td>.00</td> <td>.00</td> <td></td> </tr> <tr> <td>4"</td> <td>4.4</td> <td>4.3</td> <td>3.8</td> <td>2.7</td> <td>1.7</td> <td>1.0</td> <td>0.7</td> <td>0.4</td> <td></td> </tr> </tbody> </table>	Distance from Wall	0'	6"	1'	2'	3'	4'	5'	6'	(Horizontal Distance from Center)	2"	16.5	12.3	8.0	2.6	0.9	0.2	.00	.00		4"	4.4	4.3	3.8	2.7	1.7	1.0	0.7	0.4	
Distance from Wall	0'	6"	1'	2'	3'	4'	5'	6'	(Horizontal Distance from Center)																						
2"	16.5	12.3	8.0	2.6	0.9	0.2	.00	.00																							
4"	4.4	4.3	3.8	2.7	1.7	1.0	0.7	0.4																							



FEATURES

- Three lumen output options for just the right punch of light.
- Three beam spread options, 10°, 35° or 60°, put light where you want it.
- A range of Kelvin color temperature choices from warm white 2700K to pure white 3000K.
- Radiax™ Optics deliver the greatest lumens per watt in the industry for comparable fixtures.
- All brass construction is corrosion-free and stronger than aluminum or composite built designs.
- 15° adjustable aiming.
- Auger stake, with anti-heaving feature included.
- Durable 9V-15V operating range.
- Drive-over and walk-over rated.

LED 12V In-Ground

Go ahead and drive on them – our 12V in-ground products are designed to take it all. Multi-application, easy to install design can be embedded in hardscaping materials or concrete and the durable construction is designed to hold up against the elements. Customize to your application with the accessories shown here.



Anti-heaving, Auger-style In-Ground Stake – Included



Rockguard – Polycarbonate
Optional accessory, see page 152.

Cowl – Cast Brass
Optional accessory, see page 152.



Concrete Installation Kit
Optional accessory, see page 148.

DESIGN PRO LED 12V IN-GROUND



BBR

16030, 16031, 16032- 12V 4W LED IN-GROUND

Description	A specification-grade LED in-ground fixture collection featuring a corrosion-free all brass construction that can be utilized in many types of commercial and residential applications
Ordering Guide & Finish	Bronzed Brass
Housing	Cast Brass (brass will naturally patina over time)
Light Source	1 Integrated High Output Cree® LED, tightly binned for color uniformity, and constant current driver
Color Temp. (CCT) & CRI	2700K (-50/+100) Warm White 3000K (-45/+130) Pure White / 80s CRI
Optics	Radiax™
Power Usage at 12V AC Input VA and Watts	4W, 5.8VA Multiply fixture VA by the number of fixtures used to determine size of transformer
Operating Voltage Range	9V-15V AC/DC with no loss in output due to constant current technology
Lumen Maint.	Tested to an L-70 of 40,000 hours
Total Lumens & Efficacy	2700K = 146 Lm 3000K= 170 Lm 2700K = 37 Lm/W 3000K = 43 Lm/W
Wiring	24" of usable #18-2, SPT-1W leads. Pro series wire connectors supplied
Mounting Acces. Included	Anti-heaving, auger-style in-ground stake (included)
Optional Acces.	16501BBRP – Concrete Kit Drive-over and walk-over rated. Rated for a 4500lb car or truck
Notes	Subjected to Highly Accelerated Life Testing – 3rd party reliability testing Aimable up to 15° on the vertical. Not for use with electronic transformers *Cree is a registered trademark of Cree, Inc. IP 66 rated

ORDER GUIDE



Kelvin	2700K WARM WHITE	3000K PURE WHITE
Watts/Lumens	Compares to Halogen 20W MR16	
Beam Spread 10° Spot	16030 BBR27	16030 BBR30
Beam Spread 35° Flood	16031 BBR27	16031 BBR30
Beam Spread 60° Wide Flood	16032 BBR27	16032 BBR30

FINISH GUIDE

BBR – Bronzed Brass



DESIGN PRO LED 12V IN-GROUND



Description	A specification-grade LED in-ground fixture collection featuring a corrosion-free all brass construction that can be utilized in many types of commercial and residential applications
Ordering Guide & Finish	Bronzed Brass
Housing	Cast Brass (brass will naturally patina over time)
Light Source	5 Integrated High Output Cree® LEDs, tightly binned for color uniformity, and constant current driver
Color Temp. (CCT) & CRI	2700K (-50/+100) Warm White, 3000K (-45/+130) Pure White / 80s CRI
Optics	Radiax™
Power Usage at 12V AC Input VA and Watts	6.5W, 9.3VA Multiply fixture VA by the number of fixtures used to determine size of transformer
Operating Voltage Range	9V-15V AC/DC with no loss in output due to constant current technology
Lumen Maint.	Tested to an L-70 of 40,000 hours
Total Lumens & Efficacy	2700K = 306 Lm 3000K = 348 Lm 2700K = 47 Lm/W 3000K = 54 Lm/W
Wiring	24" of usable #18-2, SPT-1W leads. Pro series wire connectors supplied
Mounting Acces. Included	Anti-heaving, auger-style in-ground stake (included)
Optional Acces.	16501BBRP – Concrete Kit Drive-over and walk-over rated. Rated for a 4500lb car or truck
Notes	Subjected to Highly Accelerated Life Testing – 3rd party reliability testing Aimable up to 15° on the vertical. Not for use with electronic transformers *Cree is a registered trademark of Cree, Inc. IP 66 rated

ORDER GUIDE



Kelvin	2700K WARM WHITE	3000K PURE WHITE
Watts/Lumens	Compares to Halogen 35W MR16	
Beam Spread 10° Spot	16033 BBR27	16033 BBR30
Beam Spread 35° Flood	16034 BBR27	16034 BBR30
Beam Spread 60° Wide Flood	16035 BBR27	16035 BBR30

FINISH GUIDE

BBR – Bronzed Brass

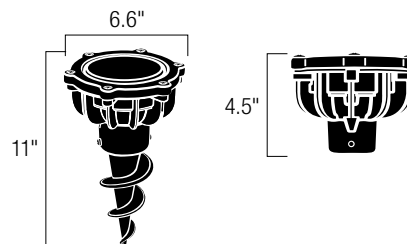

DESIGN PRO LED 12V IN-GROUND



16036, 16037, 16038- 12V 14W LED IN-GROUND

Description	A specification-grade LED in-ground fixture collection featuring a corrosion-free all brass construction that can be utilized in many types of commercial and residential applications.
Ordering Guide & Finish	Bronzed Brass
Housing	Cast Brass (brass will naturally patina over time)
Light Source	5 Integrated High Output Cree® LEDs, tightly binned for color uniformity, and constant current driver
Color Temp. (CCT) & CRI	2700K (-50/+100) Warm White, 3000K (-45/+130) Pure White / 80s CRI
Optics	Radiax™
Power Usage at 12V AC Input VA and Watts	14W, 18.5VA Multiply fixture VA by the number of fixtures used to determine size of transformer
Operating Voltage Range	9V-15V AC/DC with no loss in output due to constant current technology
Lumen Maint.	Tested to an L-70 of 40,000 hours
Total Lumens & Efficacy	2700K = 520 Lm 3000K= 590 Lm 2700K = 37 Lm/W 3000K = 42 Lm/W
Wiring	24" of usable #18-2, SPT-1W leads. Pro series wire connectors supplied
Mounting Acces. Included	Anti-heaving, auger-style in-ground stake (included)
Optional Acces.	16501BBRP – Concrete Kit Drive-over and walk-over rated. Rated for a 4500lb car or truck
Notes	Subjected to Highly Accelerated Life Testing – 3rd party reliability testing Aimable up to 15° on the vertical. Not for use with electronic transformers *Cree is a registered trademark of Cree, Inc. IP 66 rated

ORDER GUIDE

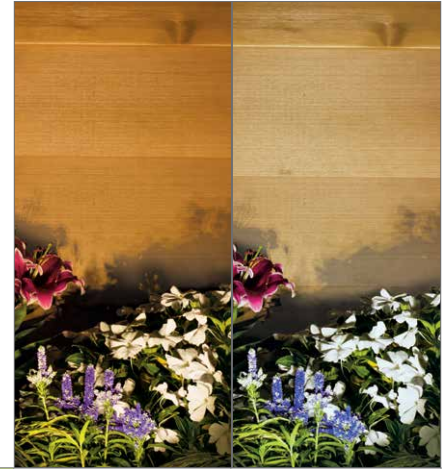

Kelvin	2700K WARM WHITE	3000K PURE WHITE
Watts/Lumens	Compares to Halogen 50W MR16	
Beam Spread 10° Spot	16036 BBR27	16036 BBR30
Beam Spread 35° Flood	16037 BBR27	16037 BBR30
Beam Spread 60° Wide Flood	16038 BBR27	16038 BBR30

FINISH GUIDE

BBR – Bronzed Brass





15767, 15768, 15769

15728, 15747, 15748

15729, 15757, 15758 BKT

Description	LED technology in a versatile design with reversible support sleeve to accommodate uplighting when flush mounting or angled lighting are desired in a semi-recessed application. Fully adjustable and available in a wide variety of outputs and beam spreads.		
Ordering Guide & Finish	15767 BKT - 10° spot 15768 BKT - 35° flood 15769 BKT - 60° wide flood	15728 BKT - 10° spot 15747 BKT - 35° flood 15748 BKT - 60° wide flood	15729 BKT - 10° spot 15757 BKT - 35° flood 15758 BKT - 60° wide flood
Housing	Cast aluminum fixture body with a heavy duty polypropylene sleeve and stainless steel gimble ring.		
Light Source	3 Integrated High Output Nichia® LEDs, tightly binned for color uniformity, and constant current driver	6 Integrated High Output Nichia® LEDs, tightly binned for color uniformity, and constant current driver	9 Integrated High Output Nichia® LEDs, tightly binned for color uniformity, and constant current driver
Color Temp. (CCT) & CRI	3000K (-200/+125) / 80s CRI		
Power Usage at 12V AC Input VA and Watts	4.5W, 7.5VA Multiply fixture VA by the number of fixtures used to determine size of transformer	8.5W, 12.2VA Multiply fixture VA by the number of fixtures used to determine size of transformer	12.4W, 16.7VA Multiply fixture VA by the number of fixtures used to determine size of transformer
Operating Voltage Range	9V-15V AC/DC with no loss in output due to constant current technology		
Lumen Maint.	Tested to an L-70 of 40,000 hours		
Total Lumens & Efficacy	3000K = 150 Lm 3000K = 33 Lm/W	3000K = 310 Lm 3000K = 36 Lm/W	3000K = 460 Lm 3000K = 37 Lm/W
Wiring	35" of useable #18-2, SPT-1W leads. Cable connector supplied		
Optional Acces.	Snap on Cowls: 15701BKTP - Short 4.5W/8.5W, 15702BKTP - Short 12.4W , 15703BKTP - Long 4.5W/8.5W, 15704BKTP - Long 12.4W Rockguards/ Glare Shield: 15787BK - Fits all versions Custom Lenses: Amber - 4.5W/8.5W - 15875AMB, Amber - 12.4W - 15876AMB, Green - 4.5W/8.5W - 15885GRN, Green - 12.4W - 15886GRN, Frosted - 4.5W/8.5W - 15895FRO, Frosted - 12.4W - 15896FRO		
Notes	See photometrics on page 199. Kichler LED Comparison: 4.5W is approximately comparable to a 20W MR16, a 8.5W to a 35W MR16, and a 12.4W to a 50W MR16. Subjected to Highly Accelerated Life Testing - 3rd party reliability testing. Not for use with electronic transformers		

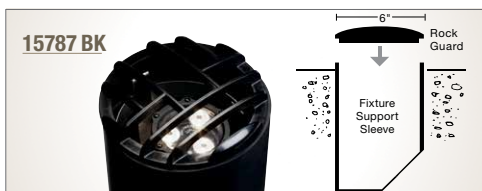

15787 BK - LED IN-GROUND COVER	
Description	Rock guard accessory for Design Pro LED In-Ground Light Series
Ordering Guide & Finish	Black Polycarbonate (High Strength)
Notes	15787 BK snaps easily into place on flat side of fixture's sleeve.



KICHLER®

Design Pro LED 12V 2-in-1 Water/Accent Light

Versatile lighting that's at home in and out of water.

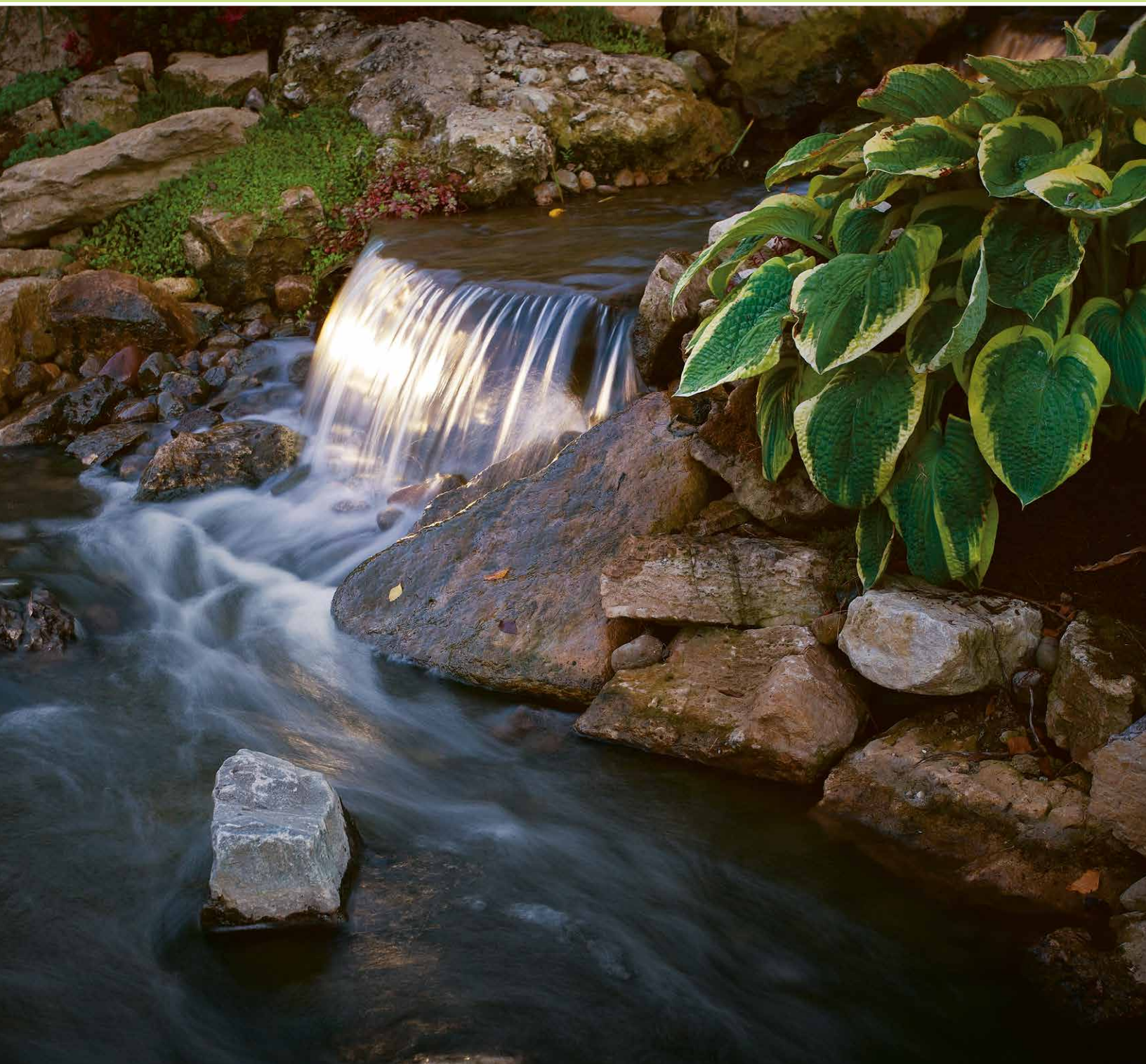

DESIGN PRO LED 12V WATER/ACCENT



15711 SS - 2-IN-1 WATER/ACCENT LIGHT



15777 SS

Stainless steel easy mount bracket (fixture sold separately) for use above ground on any surface – ideal for wood and masonry when used on decks, patios or overhangs.



15776 BK

Unique heavy weighted 3 pronged underwater accessory for 2 or 3 fixtures (sold separately) to give maximum flexibility and directional capability.



15778 BK

Heavy weight 1 prong underwater light (sold separately) accessory for standard installations. Provides advanced directional capability.

Description	Designed for underwater use in ponds, fountains, and other water features. Can also be used out of water as a mini accent light – ideal for wood decks and overhangs		
Ordering Guide & Finish	15711 SS - Stainless Steel		
Housing	Stainless Steel housing with integrated cowl		
Light Source	1 Integrated High Output Nichia LED, tightly binned for color uniformity, and constant current driver		
Beam Spread	60°		
Color Temp. (CCT) & CRI	3000K (-200/+125) / 80s CRI		
Optics	Custom Reflector Optic		
Power Usage at 12V AC Input VA and Watts	3.4 W, 4.9 VA Multiply fixture VA by the number of fixtures used to determine size of transformer		
Operating Voltage Range	9V-15V AC/DC with no loss in output due to constant current technology		
Lumen Maint.	Tested to an L-70 of 40,000 hours		
Total Lumens & Efficacy	3000K = 150 Lm 3000K= 44 Lm/W		
Wiring	25ft of usable #18-2, SPT-2W leads		
Mounting Acces.	15776 BK - Multi-fixture weighted base. U.S. Patent Pending 15777 SS - Out-of-water bracket. U.S. Patent Pending 15778 BK - Single-fixture weighted base. U.S. Patent Pending		
Notes	Filled and sealed with two types of premium encapsulant to ensure fixture is completely watertight, 1/4-20 threaded mounting tap. Subjected to Highly Accelerated Life Testing - 3rd party reliability testing. Not for use with electronic transformers		
Fixture Photometric (fc)	Distance from Source (ft)	Illuminance (footcandles)	Beam Width (ft)
Water reduces light output by 10% per foot of depth	4	5.6	3.3
	8	1.5	6.5
	16	0.4	13.0
	24	0.2	19.5
	32	0.1	26.0
	40	0.1	32.5

DESIGN PRO LED 12V WATER/ACCENT

D





KICHLER®

Incandescent / LED 12V Hybrid Path & Spread

Let stylish design and durable construction light the way.



INCANDESCENT / LED 12V HYBRID PATH & SPREAD



15379 OZ - GATE HOUSE™

15446 OZ - ARIES MANOR™

15447 OZ - ARIES MANOR™

Description	Classic estate styling.	An elegant and stately path light featuring solid brass construction, a turned spindle stem.	An elegant and stately indirect path light featuring solid brass construction and a turned spindle stem.
Ordering Guide & Finish	15379 OZ - Olde Bronze®	15446 OZ - Olde Bronze®	15447 OZ - Olde Bronze®
Housing	Cast Brass	Brass with cocoa turned marble accent. Citrine glass.	Brass with cocoa turned marble accent.
Lamp Base	12V S8 wedge base socket	12V T5 wedge base socket	12V T5 wedge base socket
Supplied Lamp	24.4-W(VA) 3156K (15598 CLR) Krypton light source Power usage at 12V AC input VA MAX: 24.4-W(VA)	16.25-W(VA) 921X (17025) Xenon light source Power usage at 12V AC input VA MAX: 16.25-W(VA)	11.6-W(VA) 912X (17023) Xenon light source Power usage at 12V AC input VA MAX: 16.25-W(VA)
Incandescent Lamp Options	18.5-W(VA) 3155K (15599 CLR)	11.6-W(VA) 912X (17023) 6.5-W(VA) 918X (17022) 4-W(VA) 901X (17021)	16.25-W(VA) 921X (17025) 6.5-W(VA) 918X (17022) 4-W(VA) 901X (17021)
LED Lamp Options	2W (18036-18038) see page 159 Compares up to 18.5W Krypton	2W (18039-18041) see page 159 Compares up to 16W Xenon	2W (18039-18041) see page 159 Compares up to 16W Xenon
Wiring	34" of usable #18-2, SPT-1-W leads Cable connector supplied	24" of usable #18-2, SPT-1-W leads Cable connector supplied	24" of usable #18-2, SPT-1-W leads Cable connector supplied
Mounting Acces. Included	14" In-ground stake	8" In-ground stake	8" In-ground stake
Optional Acces.	15601 - Surface Mounting Flange 15607 - Surface Mounting Bracket	15601 - Surface Mounting Flange 15607 - Surface Mounting Bracket	15601 - Surface Mounting Flange 15607 - Surface Mounting Bracket
Notes	U.S. Patent No. D561,371	N/A	N/A
Photometric with Supplied Lamp	Distance from Light 0' 1' 2' 3' 4' 5' 6' 7' 8'	Distance from Light 0' 1' 2' 3' 4' 5' 6' 7' 8'	Distance from Light 0' 1' 2' 3' 4' 5' 6' 7' 8'
	Footcandles 8.16 3.43 3.43 1.46 .33 - - - -	Footcandles 0.5 1.1 0.8 0.4 0.1 0 - - - -	Footcandles 6.9 4.9 2.9 1.3 0.4 0.1 - - - -

Denotes fixture is compatible with incandescent or LED lamps.

INCANDESCENT / LED 12V HYBRID PATH & SPREAD



15314 AZT, MST - SINGLE-TIER LEAF

15436 OZ - INTAGLIO BRASS CROOK NECK

15347 VGB - AINSLEY SQUARE™

Description	Delicate leaf form casts a warm, diffused light along a walkway or near an entryway.	A richly detailed solid and heavy crookneck path light with a brass shade that has been engraved and etched with an organic pattern.	Pierced brass dome and stem and verdigris finish for stylish path lighting.																																																												
Ordering Guide & Finish	15314 AZT - Textured Architectural Bronze 15314 MST - Textured Midnight Spruce™	15436 OZ - Olde Bronze®	15347 VGB - Verdigris with Aged Brass																																																												
Housing	Cast Aluminum	Brass	Brass																																																												
Lamp Base	12V S8 wedge base socket	12V T5 wedge base socket	12V S8 wedge base socket																																																												
Supplied Lamp	24.4-W(VA) 3156K (15598 CLR) Krypton light source Power usage at 12V AC input VA MAX: 24.4-W(VA)	11.6-W(VA) 912X (17023) Xenon light source Power usage at 12V AC input VA MAX: 16.25-W(VA)	24.2-W(VA) 3156K (15598 CLR) Krypton light source Power usage at 12V AC input VA MAX: 24.4-W(VA)																																																												
Incandescent Lamp Options	18.5-W(VA) 3155K (15599 CLR)	16.25-W(VA) 921X (17025) 6.5-W(VA) 918X (17022) 4-W(VA) 901X (17021)	18.5-W(VA) 3155K (15599 CLR)																																																												
LED Lamp Options	2W (18036-18038) see page 159 Compares up to 18.5W Krypton	2W (18039-18041) see page 159 Compares up to 16W Xenon	2W (18036-18038) see page 159 Compares up to 18.5W Krypton																																																												
Wiring	35" of usable #18-2, SPT-1-W leads Cable connector supplied	26" of usable #18-2, SPT-1-W leads Cable connector supplied	32" of usable #18-2, SPT-1-W leads Cable connector supplied																																																												
Mounting Acces. Included	8" In-ground stake	8" In-ground stake	8" In-ground stake																																																												
Optional Acces.	15601 - Surface Mounting Flange 15607 - Surface Mounting Bracket	15601 - Surface Mounting Flange 15607 - Surface Mounting Bracket	15601 - Surface Mounting Flange 15607 - Surface Mounting Bracket																																																												
Notes	N/A	N/A	U.S. Patent Pending																																																												
Photometric with Supplied Lamp	<table border="1"> <tr> <td>Distance from Light</td> <td>1'</td><td>2'</td><td>3'</td><td>4'</td><td>5'</td><td>6'</td><td>7'</td><td>8'</td><td>9'</td> </tr> <tr> <td>Footcandles</td> <td>2.6</td><td>3.2</td><td>1.2</td><td>.5</td><td>.2</td><td>-</td><td>-</td><td>-</td><td>-</td> </tr> </table>	Distance from Light	1'	2'	3'	4'	5'	6'	7'	8'	9'	Footcandles	2.6	3.2	1.2	.5	.2	-	-	-	-	<table border="1"> <tr> <td>Distance from Light</td> <td>0'</td><td>1'</td><td>2'</td><td>3'</td><td>4'</td><td>5'</td><td>6'</td><td>7'</td><td>8'</td> </tr> <tr> <td>Footcandles</td> <td>8.9</td><td>5.3</td><td>2.1</td><td>0.5</td><td>.02</td><td>0</td><td>-</td><td>-</td><td>-</td> </tr> </table>	Distance from Light	0'	1'	2'	3'	4'	5'	6'	7'	8'	Footcandles	8.9	5.3	2.1	0.5	.02	0	-	-	-	<table border="1"> <tr> <td>Distance from Light</td> <td>0'</td><td>1'</td><td>2'</td><td>3'</td><td>4'</td><td>5'</td><td>6'</td><td>7'</td><td>8'</td> </tr> <tr> <td>Footcandles</td> <td>2.7</td><td>1.1</td><td>.3</td><td>.2</td><td>-</td><td>-</td><td>-</td><td>-</td><td>-</td> </tr> </table>	Distance from Light	0'	1'	2'	3'	4'	5'	6'	7'	8'	Footcandles	2.7	1.1	.3	.2	-	-	-	-	-
Distance from Light	1'	2'	3'	4'	5'	6'	7'	8'	9'																																																						
Footcandles	2.6	3.2	1.2	.5	.2	-	-	-	-																																																						
Distance from Light	0'	1'	2'	3'	4'	5'	6'	7'	8'																																																						
Footcandles	8.9	5.3	2.1	0.5	.02	0	-	-	-																																																						
Distance from Light	0'	1'	2'	3'	4'	5'	6'	7'	8'																																																						
Footcandles	2.7	1.1	.3	.2	-	-	-	-	-																																																						

Denotes fixture is compatible with incandescent or LED lamps.

INCANDESCENT / LED 12V HYBRID PATH & SPREAD



15369 TZT - VINTAGE PARK™

15393 OZ - KENTUCKY

15426 BKT - ALMERIA™

Description	Graceful curves and elegant detailing in a vintage design.	Classic path light tastefully captures the traditional hunt club style.	Graceful curves and elegant detail are silhouetted by a tawny glow for a classic elegant look emulating Mediterranean sophistication.
Ordering Guide & Finish	15369 TZT - Textured Tannery Bronze™	15393 OZ - Olde Bronze®	15426 BKT - Textured Black
Housing	Cast Aluminum with tea dust glass	Cast Brass with light linen glass	Aluminum and Brass with light umber glass
Lamp Base	12V S8 wedge base socket	12V T5 wedge base socket	12V T5 wedge base socket
Supplied Lamp	18.5-W(VA) 3155K (15599 CLR) Krypton light source Power usage at 12V AC input VA MAX: 18.5-W(VA)	11.6-W(VA) 912X (17023) Xenon light source Power usage at 12V AC input VA MAX: 16.25-W(VA)	11.6-W(VA) 912X (17023) Xenon light source Power usage at 12V AC input VA MAX: 11.6-W(VA)
Incandescent Lamp Options	N/A	16.25-W(VA) 921X (17025) 6.5-W(VA) 918X (17022) 4-W(VA) 901X (17021)	6.5-W(VA) 918X (17022) 4-W(VA) 901X (17021)
LED Lamp Options	2W (18036-18038) see page 159 Compares up to 18.5W Krypton	2W (18039-18041) see page 159 Compares up to 16W Xenon	2W (18039-18041) see page 159 Compares up to 16W Xenon
Wiring	32" of usable #18-2, SPT-1-W leads Cable connector supplied	41" of usable #18-2, SPT-1-W leads Cable connector supplied	34" of usable #18-2, SPT-1-W leads Cable connector supplied
Mounting Acces. Included	8" In-ground stake	8" In-ground stake	8" In-ground stake
Optional Acces.	15601 - Surface Mounting Flange 15607 - Surface Mounting Bracket	15601 - Surface Mounting Flange 15607 - Surface Mounting Bracket	15601 - Surface Mounting Flange 15607 - Surface Mounting Bracket
Notes	U.S. Patent No. D570,517	U.S. Patent Pending	U.S. Patent No. D578,238
Photometric with Supplied Lamp	Distance from Light 0' 1' 2' 3' 4' 5' 6' 7' 8' Footcandles 10.13 4 .9 .1 - - - - -	Distance from Light 6" 1' 2' 3' 4' 5' 6' 7' 8' Footcandles 8.96 2.6 .43 .13 - - - -	Distance from Light 0' 1' 2' 3' 4' 5' 6' 7' 8' Footcandles 10 5.2 .8 .2 - - - - -

Denotes fixture is compatible with incandescent or LED lamps.

INCANDESCENT / LED 12V HYBRID PATH & SPREAD



	15422 AGZ - COTSWOLD™	15420 AGZ - COTSWOLD™
Description	Curvy edition with old world charm, this path light spreads light with style that blends into nature for a lower profile light source.	Lantern style path light with an old world, curvy cap. A curly stem adds unique charm to a popular traditional look.
Ordering Guide & Finish	15422 AGZ - Aged Bronze	15420 AGZ - Aged Bronze
Housing	Cast Aluminum	Cast Aluminum with weathered white glass
Lamp Base	12V T5 wedge base socket	12V T5 wedge base socket
Supplied Lamp	11.6-W(VA) 912X (17023) Xenon light source Power usage at 12V AC input VA MAX: 16.25-W(VA)	11.6-W(VA) 912X (17023) Xenon light source Power usage at 12V AC input VA MAX: 16.25-W(VA)
Incandescent Lamp Options	16.25-W(VA) 921X (17025) 6.5-W(VA) 918X (17022) 4-W(VA) 901X (17021)	16.25-W(VA) 921X (17025) 6.5-W(VA) 918X (17022) 4-W(VA) 901X (17021)
LED Lamp Options	2W (18039-18041) see page 159 Compares up to 16W Xenon	2W (18039-18041) see page 159 Compares up to 16W Xenon
Wiring	26" of usable #18-2, SPT-1-W leads. Cable connector supplied	28" of usable #18-2, SPT-1-W leads. Cable connector supplied
Mounting Acces. Included	8" In-ground stake	8" In-ground stake
Optional Acces.	15601 - Surface Mounting Flange 15607 - Surface Mounting Bracket	15601 - Surface Mounting Flange 15607 - Surface Mounting Bracket
Photometric with Supplied Lamp	Distance from Light 0' 1' 2' 3' 4' 5' 6' 7' 8'	Distance from Light 0' 1' 2' 3' 4' 5' 6' 7' 8'
	Footcandles 8.8 7 3.6 1.4 .4 - - - -	Footcandles 14.9 2.5 1.3 .5 .1 - - - -

Denotes fixture is compatible with incandescent or LED lamps.

INCANDESCENT / LED 12V HYBRID PATH & SPREAD



15421 AGZ - COTSWOLD™ CONVERTIBLE HEIGHT TIKI



15449 TZT - CATHEDRAL BOLLARD

Description	Adjustable-height stem converts path light to a Tiki torch style for use around patios, barbecue grills or outdoor dining areas.	Cathedral arches and interwoven bands created to form a transitional stanchion for the garden's edge.
Ordering Guide & Finish	15421 AGZ - Aged Bronze	15449 TZT - Textured Tannery Bronze™
Housing	Cast Aluminum with weathered white glass	Aluminum with dark citrine glass
Lamp Base	12V T5 wedge base socket	12V T5 wedge base socket
Supplied Lamp	11.6-W(VA) 912X (17023) Xenon light source Power usage at 12V AC input VA MAX: 16.26-W(VA)	11.6-W(VA) 912X (17023) (2) Xenon light source Power usage at 12V AC input VA MAX: 16.25-W(VA)
Incandescent Lamp Options	16.25-W(VA) 921X (17025) 6.5-W(VA) 918X (17022) 4-W(VA) 901X (17021)	16.25-W(VA) 921X (17025) 6.5-W(VA) 918X (17022) 4-W(VA) 901X (17021) (2 required)
LED Lamp Options	2W (18039-18041) see page 159 Compares up to 16W Xenon	2W (18039-18041) see page 159 Compares up to 16W Xenon
Wiring	24" of usable #18-2, SPT-1-W leads at high position. 50" usable leads at low position. Cable connector supplied	22" of usable #18-2, SPT-1-W leads. Cable connector supplied
Mounting Acces. Included	14" In-ground stake	8" In-ground stake
Optional Acces.	15601 - Surface Mounting Flange 15607 - Surface Mounting Bracket	N/A
Photometric with Supplied Lamp	Distance from Light 0' 1' 2' 3' 4' 5' 6' 7' 8' (at 32" height) Footcandles .25 .3 .2 .1 - - - - -	Distance from Light 0' 1' 2' 3' 4' 5' 6' 7' 8' Footcandles 0.44 1.81 1.26 0.70 0.39 0.25 0.16 .012 0.10

Denotes fixture is compatible with incandescent or LED lamps.

INCANDESCENT / LED 12V HYBRID PATH & SPREAD



	15429 TZT - CATHEDRAL™	15457 AZT - PIERCED DOME
Description	Transitional styling with draped arches of interwoven bands.	A cast dome sculpted with a floral band and pierced to reveal a trickle of light.
Ordering Guide & Finish	15429 TZT - Textured Tannery Bronze™	15457 AZT -Textured Architectural Bronze™
Housing	Aluminum	Cast Aluminum
Lamp Base	12V T5 wedge base socket 	12V T5 wedge base socket 
Supplied Lamp	11.6-W(VA) 912X (17023) Xenon light source Power usage at 12V AC input VA MAX: 16.25-W(VA)	16.25-W(VA) 921X (17025) Xenon light source Power usage at 12V AC input VA MAX: 16.25-W(VA)
Incandescent Lamp Options	16.25-W(VA) 921X (17025) 6.5-W(VA) 918X (17022) 4-W(VA) 901X (17021)	11.6-W(VA) 912X (17023) 6.5-W(VA) 918X (17022) 4-W(VA) 901X (17021)
LED Lamp Options	2W (18039-18041) see page 159 Compares up to 16W Xenon	2W (18039-18041) see page 159 Compares up to 16W Xenon
Wiring	24" of usable #18-2, SPT-1-W leads. Cable connector supplied	24" of usable #18-2, SPT-1-W leads. Cable connector supplied
Mounting Acces. Included	8" In-ground stake (Included)	8" In-ground stake (Included)
Optional Acces.	15601 - Surface Mounting Flange 15607 - Surface Mounting Bracket	15601 - Surface Mounting Flange 15607 - Surface Mounting Bracket
Photometric with Supplied Lamp	Distance from Light 0' 1' 2' 3' 4' 5' 6' 7' 8'	Distance from Light 0' 1' 2' 3' 4' 5' 6' 7' 8'
	Footcandles 7.52 5.42 0.47 1.15 0.32 0.05 - - -	Footcandles 9.36 5.22 3.76 2.02 0.89 0.12 0.05 - -

 Denotes fixture is compatible with incandescent or LED lamps.

INCANDESCENT / LED 12V HYBRID PATH & SPREAD



15437 TZT - PIERCED SCROLLWORK

15330 OZ - ADJUSTABLE CRESENT

Description	Classic style scrollwork is pierced and shaped into a pyramid allowing the light to play against the sculpted textures.	Adjustable shade on this versatile fixture allows it to be used as a path or accent light or for wall washing.																																								
Ordering Guide & Finish	15437 TZT - Textured Tannery Bronze™	15330 OZ - Olde Bronze®																																								
Housing	Cast Aluminum	Brass																																								
Lamp Base	12V T5 wedge base socket	12V S8 wedge base socket																																								
Supplied Lamp	16.25-W(VA) 921X (17025) Xenon light source Power usage at 12V AC input VA MAX: 16.25-W(VA)	24.4-W(VA) 3156K (15598 CLR) Krypton light source Power usage at 12V AC input VA MAX: 24.4-W(VA)																																								
Incandescent Lamp Options	11.6-W(VA) 912X (17023) 6.5-W(VA) 918X (17022) 4-W(VA) 901X (17021)	18.5-W(VA) 3155K (15599 CLR)																																								
LED Lamp Options	2W (18039-18041) see page 159 Compares up to 16W Xenon	2W (18036-18038) see page 159 Compares up to 18.5W Krypton																																								
Wiring	24" of usable #18-2, SPT-1-W leads. Cable connector supplied	42" of usable #18-2, SPT-1-W leads. Cable connector supplied																																								
Mounting Acces. Included	8" In-ground stake (Included)	8" In-ground stake (Included)																																								
Optional Acces.	15601 - Surface Mounting Flange 15607 - Surface Mounting Bracket	15601 - Surface Mounting Flange 15607 - Surface Mounting Bracket																																								
Photometric with Supplied Lamp	<table border="1"> <tr> <td>Distance from Light</td> <td>0'</td><td>1'</td><td>2'</td><td>3'</td><td>4'</td><td>5'</td><td>6'</td><td>7'</td><td>8'</td> </tr> <tr> <td>Footcandles</td> <td>11.04</td><td>6.99</td><td>3.14</td><td>1.56</td><td>0.44</td><td>0.10</td><td>0.05</td><td>0.03</td><td>-</td> </tr> </table>	Distance from Light	0'	1'	2'	3'	4'	5'	6'	7'	8'	Footcandles	11.04	6.99	3.14	1.56	0.44	0.10	0.05	0.03	-	<table border="1"> <tr> <td>Distance from Light</td> <td>0'</td><td>1'</td><td>2'</td><td>3'</td><td>4'</td><td>5'</td><td>6'</td><td>7'</td><td>8'</td> </tr> <tr> <td>Footcandles</td> <td>15.18</td><td>9.98</td><td>4.13</td><td>1.52</td><td>.6</td><td>.22</td><td>.03</td><td>-</td><td>-</td> </tr> </table>	Distance from Light	0'	1'	2'	3'	4'	5'	6'	7'	8'	Footcandles	15.18	9.98	4.13	1.52	.6	.22	.03	-	-
Distance from Light	0'	1'	2'	3'	4'	5'	6'	7'	8'																																	
Footcandles	11.04	6.99	3.14	1.56	0.44	0.10	0.05	0.03	-																																	
Distance from Light	0'	1'	2'	3'	4'	5'	6'	7'	8'																																	
Footcandles	15.18	9.98	4.13	1.52	.6	.22	.03	-	-																																	

Denotes fixture is compatible with incandescent or LED lamps.

INCANDESCENT / LED 12V HYBRID PATH & SPREAD



	15401 AZT - THATCHED ROOF	15443 CO, OB, OB12, TZT, VG - DECORATIVE HAMMERED ROOF																																								
Description	The casual style indicative of island life is reproduced in this cast aluminum lighting fixture. Coordinates with matching deck light 15461 on page 105.	Pierced shade sheds decorative patterned light over shrubs or gardens.																																								
Ordering Guide & Finish	15401 AZT - Textured Architectural Bronze	15443 CO - Unfinished Copper, Copper 15443 OB - Olde Brick®, Brass 15443 OB12 - Same as 15443OB. Bulk packed in 12 (unbreakable master) 15443 TZT - Textured Tannery Bronze™, Brass 15443 VG - Verdigris, Brass																																								
Housing	Cast Aluminum with clear glass sprinkler shield	Brass or Copper (Copper will naturally patina over time)																																								
Lamp Base	12V T3 bi-pin, high temperature porcelain socket	12V S8 wedge base socket																																								
Supplied Lamp	20-W(VA) T3 (17012) Halogen light source Power usage at 12V AC input VA MAX: 20-W(VA)	24.4-W(VA) 3156K (15598 CLR) Krypton light source Power usage at 12V AC input VA MAX: 24.4-W(VA)																																								
Incandescent Lamp Options	10-W(VA) T-3 (17011)	18.5-W(VA) 3155K (15599 CLR)																																								
LED Lamp Options	2W (18042-18044) see page 159 Compares up to 20W Halogen	2W (18036-18038) see page 159 Compares up to 18.5W Krypton																																								
Wiring	20" of usable #18-2, SPT-1-W leads. Cable connector supplied	35" of usable #18-2, SPT-1-W leads. Cable connector supplied																																								
Mounting Acces. Included	8" In-ground stake (Included)	8" In-ground stake (Included)																																								
Optional Acces.	15601 - Surface Mounting Flange 15607 - Surface Mounting Bracket	15601 - Surface Mounting Flange 15607 - Surface Mounting Bracket																																								
Integrated LED Options	N/A	15843 on page 10.																																								
Notes	N/A	U.S. Patent No. D408,573																																								
Photometric with Supplied Lamp	<table border="1"> <tr> <td>Distance from Light</td> <td>0'</td> <td>1'</td> <td>2'</td> <td>3'</td> <td>4'</td> <td>5'</td> <td>6'</td> <td>7'</td> <td>8'</td> </tr> <tr> <td>Footcandles</td> <td>9.9</td> <td>7.3</td> <td>1.7</td> <td>.76</td> <td>.16</td> <td>-</td> <td>-</td> <td>-</td> <td>-</td> </tr> </table>	Distance from Light	0'	1'	2'	3'	4'	5'	6'	7'	8'	Footcandles	9.9	7.3	1.7	.76	.16	-	-	-	-	<table border="1"> <tr> <td>Distance from Light</td> <td>1'</td> <td>2'</td> <td>3'</td> <td>4'</td> <td>5'</td> <td>6'</td> <td>7'</td> <td>8'</td> <td>9'</td> </tr> <tr> <td>Footcandles</td> <td>8.9</td> <td>2.8</td> <td>.6</td> <td>.15</td> <td>-</td> <td>-</td> <td>-</td> <td>-</td> <td>-</td> </tr> </table>	Distance from Light	1'	2'	3'	4'	5'	6'	7'	8'	9'	Footcandles	8.9	2.8	.6	.15	-	-	-	-	-
Distance from Light	0'	1'	2'	3'	4'	5'	6'	7'	8'																																	
Footcandles	9.9	7.3	1.7	.76	.16	-	-	-	-																																	
Distance from Light	1'	2'	3'	4'	5'	6'	7'	8'	9'																																	
Footcandles	8.9	2.8	.6	.15	-	-	-	-	-																																	

Denotes fixture is compatible with incandescent or LED lamps.

INCANDESCENT / LED 12V HYBRID PATH & SPREAD



15471 BBR, TZT - CAST HAMMERED ROOF

15418 AZT - RIBBED ROOF

15349 MST - TULIP

Description	Pierced shade sheds decorative patterned light over shrubs, gardens, or walkways.	Simple ribs and valleys are combined with a fluted column to blend with every landscape setting and any home exterior. Coordinates with matching deck light 15468 on page 110.	Traditionally elegant tulip shade on a grace-fully curved stem. Effective as a grouping in a flower bed or along a path.
Ordering Guide & Finish	15471 BBR - Bronzed Brass, Brass 15471 TZT - Textured Tannery Bronze™, Aluminum	15418 AZT - Textured Architectural Bronze™	15349 MST - Textured Midnight Spruce™
Housing	Cast Aluminum, Cast Brass	Cast Aluminum with clear glass sprinkler shield	Aluminum
Lamp Base	12V S8 wedge base socket	12V T3 bi-pin, high temperature porcelain socket	12V S8 wedge base socket
Supplied Lamp	24.4-W(VA) 3156K (15598CLR) Krypton light source Power usage at 12V AC input VA MAX: 24.4-W(VA)	20-W(VA) T3 (17012) halogen Halogen light source Power usage at 12V AC input VA MAX: 20-W(VA)	18.5-W(VA) 3155K (15599 CLR) Krypton light source Power usage at 12V AC input VA MAX: 18.5-W(VA)
Incandescent Lamp Options	18.5-W(VA) 3155K (15599CLR)	10-W(VA) T-3 (17011)	N/A
LED Lamp Options	2W (18036-18038) see page 159 Compares up to 18.5W Krypton	2W (18042-18044) see page 159	2W (18036-18038) see page 159 Compares up to 18.5W Krypton
Wiring	35" of useable #18-2, SPT-1-W leads. Cable connector supplied	20" of useable #18-2, SPT-1-W leads. Cable connector supplied	37" of useable #18-2, SPT-1-W leads. Cable connector supplied
Mounting Acces. Included	8" In-ground stake	8" In-ground stake	8" In-ground stake
Optional Acces.	15601 - Surface Mounting Flange 15607 - Surface Mounting Bracket	15601 - Surface Mounting Flange 15607 - Surface Mounting Bracket	15601 - Surface Mounting Flange 15607 - Surface Mounting Bracket
Integrated LED Options	15871 on page 10.	NA	NA
Photometric with Supplied Lamp	Distance from Light 1' 2' 3' 4' 5' 6' 7' 8' 9' Footcandles 8.9 2.8 .6 .15 - - - - -	Distance from Light 1' 2' 3' 4' 5' 6' 7' 8' 9' Footcandles 11.7 5.4 1.1 .2 - - - - -	Distance from Light 1' 2' 3' 4' 5' 6' 7' 8' 9' Footcandles 12.7 4.1 1 .2 .07 .02 - - -

Denotes fixture is compatible with incandescent or LED lamps.

INCANDESCENT / LED 12V HYBRID PATH & SPREAD



15313 TZG - LAFAYETTE™ LANTERN

15444 OZ - LARKIN ESTATE™

Description	A traditional lantern with French influence for a distinctive look.	Classic prairie styling employing a rich dark bronze finish and warm amber glass.																																								
Ordering Guide & Finish	15313 TZG - Tannery Bronze™ with Gold Accents	15444 OZ - Olde Bronze®																																								
Housing	Cast Aluminum. Linen seeded glass	Cast Brass with umber etched glass																																								
Lamp Base	12V T5 wedge base socket	12V T5 wedge base socket																																								
Supplied Lamp	16.25-W(VA) 912X (17025) Xenon light source Power usage at 12V AC input VA MAX: 16.25-W(VA)	11.6-W(VA) 912X (17023) Xenon light source Power usage at 12V AC input VA MAX: 16.25-W(VA)																																								
Incandescent Lamp Options	11.6-W(VA) 912X (17023) 6.5-W(VA) 918X (17022) 4-W(VA) 901X (17021)	16.25-W(VA) 921X (17025) 6.5-W(VA) 918X (17022) 4-W(VA) 901X (17021)																																								
LED Lamp Options	2W (18039-18041) see page 159 Compares up to 16W Xenon	2W (18039-18041) see page 159 Compares up to 16W Xenon																																								
Wiring	35" of usable #18-2, SPT-1-W leads. Cable connector supplied	40" of usable #18-2, SPT-1-W leads. Cable connector supplied																																								
Mounting Acces. Included	8" In-ground stake	8" In-ground stake																																								
Optional Acces.	15601 - Surface Mounting Flange 15607 - Surface Mounting Bracket	15601 - Surface Mounting Flange 15607 - Surface Mounting Bracket																																								
Notes	U.S. Patent Pending	N/A																																								
Photometric with Supplied Lamp	<table border="1"> <tr> <td>Distance from Light</td> <td>0'</td> <td>1'</td> <td>2'</td> <td>3'</td> <td>4'</td> <td>5'</td> <td>6'</td> <td>7'</td> <td>8'</td> </tr> <tr> <td>Footcandles</td> <td>1.3</td> <td>3</td> <td>1.96</td> <td>.86</td> <td>.33</td> <td>-</td> <td>-</td> <td>-</td> <td>-</td> </tr> </table>	Distance from Light	0'	1'	2'	3'	4'	5'	6'	7'	8'	Footcandles	1.3	3	1.96	.86	.33	-	-	-	-	<table border="1"> <tr> <td>Distance from Light</td> <td>0'</td> <td>1'</td> <td>2'</td> <td>3'</td> <td>4'</td> <td>5'</td> <td>6'</td> <td>7'</td> <td>8'</td> </tr> <tr> <td>Footcandles</td> <td>10.8</td> <td>6.9</td> <td>0.7</td> <td>0.4</td> <td>0.2</td> <td>0.1</td> <td>-</td> <td>-</td> <td>-</td> </tr> </table>	Distance from Light	0'	1'	2'	3'	4'	5'	6'	7'	8'	Footcandles	10.8	6.9	0.7	0.4	0.2	0.1	-	-	-
Distance from Light	0'	1'	2'	3'	4'	5'	6'	7'	8'																																	
Footcandles	1.3	3	1.96	.86	.33	-	-	-	-																																	
Distance from Light	0'	1'	2'	3'	4'	5'	6'	7'	8'																																	
Footcandles	10.8	6.9	0.7	0.4	0.2	0.1	-	-	-																																	

Denotes fixture is compatible with incandescent or LED lamps.

INCANDESCENT / LED 12V HYBRID PATH & SPREAD



15351 CO - COPPER CENTER MOUNT

15350 CO - ADJUSTABLE COPPER

Description	This classic brushed copper path light develops a natural verdigris patina over time.	Shade adjusts up or down. This traditional style light offers versatility in light spread and will develop a natural verdigris patina over time.																																																												
Ordering Guide & Finish	15351 CO - Unfinished Copper	15350 CO - Unfinished Copper																																																												
Housing	Copper (Copper will naturally patina over time)	Copper (Copper will naturally patina over time)																																																												
Lamp Base	12V S8 wedge base socket 	12V S8 wedge base socket																																																												
Supplied Lamp	24.4-W(VA) 3156K (15598 CLR) Krypton light source Power usage at 12V AC input VA MAX: 24.4-W(VA)	24.4-W(VA) 3156K (15598 CLR) Krypton light source Power usage at 12V AC input VA MAX: 24.4-W(VA)																																																												
Incandescent Lamp Options	18.5-W(VA) (15599 CLR)	18.5-W 3155K (15599 CLR)																																																												
LED Lamp Options	2W (18036-18038) see page 159 Compares up to 18.5W Krypton	N/A																																																												
Wiring	35" of usable #18-2, SPT-1-W leads. Cable connector supplied	21" of usable #18-2, SPT-1-W leads. Cable connector supplied																																																												
Mounting Acces. Included	8" In-ground stake	8" In-ground stake																																																												
Optional Acces.	15601 - Surface Mounting Flange 15607 - Surface Mounting Bracket	15601 - Surface Mounting Flange 15607 - Surface Mounting Bracket																																																												
Notes	N/A	N/A																																																												
Photometric with Supplied Lamp	<table border="1"> <thead> <tr> <th>Stern Height</th> <th>1'</th> <th>2'</th> <th>3'</th> <th>4'</th> <th>5'</th> <th>6'</th> <th>7'</th> <th>8'</th> <th>9'</th> </tr> </thead> <tbody> <tr> <td>18"</td> <td>10.4</td> <td>5.2</td> <td>1.9</td> <td>.83</td> <td>.23</td> <td>-</td> <td>-</td> <td>-</td> <td>-</td> </tr> </tbody> </table>	Stern Height	1'	2'	3'	4'	5'	6'	7'	8'	9'	18"	10.4	5.2	1.9	.83	.23	-	-	-	-	<table border="1"> <thead> <tr> <th>Shade Position on Stern</th> <th>1'</th> <th>2'</th> <th>3'</th> <th>4'</th> <th>5'</th> <th>6'</th> <th>7'</th> <th>8'</th> <th>9'</th> </tr> </thead> <tbody> <tr> <td>Bottom</td> <td>6.4</td> <td>5.0</td> <td>2.3</td> <td>1.0</td> <td>.4</td> <td>.1</td> <td>-</td> <td>-</td> <td>-</td> </tr> <tr> <td>Middle</td> <td>6.3</td> <td>2.7</td> <td>2.0</td> <td>.9</td> <td>.4</td> <td>.1</td> <td>-</td> <td>-</td> <td>-</td> </tr> <tr> <td>Top</td> <td>6.0</td> <td>2.4</td> <td>.8</td> <td>.3</td> <td>.1</td> <td>-</td> <td>-</td> <td>-</td> <td>-</td> </tr> </tbody> </table>	Shade Position on Stern	1'	2'	3'	4'	5'	6'	7'	8'	9'	Bottom	6.4	5.0	2.3	1.0	.4	.1	-	-	-	Middle	6.3	2.7	2.0	.9	.4	.1	-	-	-	Top	6.0	2.4	.8	.3	.1	-	-	-	-
Stern Height	1'	2'	3'	4'	5'	6'	7'	8'	9'																																																					
18"	10.4	5.2	1.9	.83	.23	-	-	-	-																																																					
Shade Position on Stern	1'	2'	3'	4'	5'	6'	7'	8'	9'																																																					
Bottom	6.4	5.0	2.3	1.0	.4	.1	-	-	-																																																					
Middle	6.3	2.7	2.0	.9	.4	.1	-	-	-																																																					
Top	6.0	2.4	.8	.3	.1	-	-	-	-																																																					

 Denotes fixture is compatible with incandescent or LED lamps.

INCANDESCENT / LED 12V HYBRID PATH & SPREAD



15391 OZ - ZEN GARDEN

15392 OZ - ZEN GARDEN BOLLARD

15319 PZ - MISSION LANTERN

Description	Path lighting with Far Eastern style and amber glass offers soft light with good spread for illuminating paths and walkways.	Bollard lighting with Far Eastern style and amber glass for soft lighting along a path.	California mission-style with frosted glass coordinates with contemporary, craftsman or Southwest architecture.																																																												
Ordering Guide & Finish	15391 OZ - Olde Bronze®	15392 OZ - Olde Bronze®	15319 PZ - Patina Bronze																																																												
Housing	Brass with textured amber seedy linen glass	Brass with textured amber seedy linen glass	Brass with satin-etched glass																																																												
Lamp Base	12V T5 wedge base socket	12V T5 wedge base socket	12V S8 wedge base socket																																																												
Supplied Lamp	11.6-W(VA) 912X (17023) Xenon light source Power usage at 12V AC input VA MAX: 16.25-W(VA)	11.6-W 912X (17023) Xenon light source Power usage at 12V AC input VA MAX: 16.25-W(VA)	18.5-W(VA) 3155K (15599 CLR) Krypton light source Power usage at 12V AC input VA MAX: 18.5-W(VA)																																																												
Incandescent Lamp Options	16.25-W(VA) 921X (17025) 6.5-W(VA) 918X (17022) 4-W(VA) 901X (17021)	16.25-W(VA) 921X (17025) 6.5-W(VA) 918X (17022) 4-W(VA) 901X (17021)	N/A																																																												
LED Lamp Options	2W (18039-18041) see page 159 Compares up to 16W Xenon	2W (18039-18041) see page 159 Compares up to 16W Xenon	2W (18036-18038) see page 159 Compares up to 18.5W Krypton																																																												
Wiring	30" of usable #18-2, SPT-1-W leads Cable connector supplied	35" of usable #18-2, SPT-1-W leads Cable connector supplied	40" of usable #18-2, SPT-1-W leads Cable connector supplied																																																												
Mounting Acces. Included	8" In-ground stake	8" In-ground stake	8" In-ground stake																																																												
Optional Acces.	15601 - Surface Mounting Flange 15607 - Surface Mounting Bracket	15601 - Surface Mounting Flange 15607 - Surface Mounting Bracket	15601 - Surface Mounting Flange 15607 - Surface Mounting Bracket																																																												
Notes	U.S. Patent Pending	U.S. Patent Pending																																																													
Photometric with Supplied Lamp	<table border="1"> <tr> <td>Distance from Light</td> <td>1'</td><td>2'</td><td>3'</td><td>4'</td><td>5'</td><td>6'</td><td>7'</td><td>8'</td><td>9'</td> </tr> <tr> <td>Footcandles</td> <td>3.2</td><td>1.2</td><td>.26</td><td>-</td><td>-</td><td>-</td><td>-</td><td>-</td><td>-</td> </tr> </table>	Distance from Light	1'	2'	3'	4'	5'	6'	7'	8'	9'	Footcandles	3.2	1.2	.26	-	-	-	-	-	-	<table border="1"> <tr> <td>Distance from Light</td> <td>.5'</td><td>1'</td><td>2'</td><td>3'</td><td>4'</td><td>5'</td><td>6'</td><td>7'</td><td>8'</td> </tr> <tr> <td>Footcandles</td> <td>.16</td><td>.36</td><td>.20</td><td>-</td><td>-</td><td>-</td><td>-</td><td>-</td><td>-</td> </tr> </table>	Distance from Light	.5'	1'	2'	3'	4'	5'	6'	7'	8'	Footcandles	.16	.36	.20	-	-	-	-	-	-	<table border="1"> <tr> <td>Distance from Light</td> <td>1'</td><td>2'</td><td>3'</td><td>4'</td><td>5'</td><td>6'</td><td>7'</td><td>8'</td><td>9'</td> </tr> <tr> <td>Footcandles</td> <td>21.1</td><td>7.3</td><td>1.7</td><td>.7</td><td>.5</td><td>-</td><td>-</td><td>-</td><td>-</td> </tr> </table>	Distance from Light	1'	2'	3'	4'	5'	6'	7'	8'	9'	Footcandles	21.1	7.3	1.7	.7	.5	-	-	-	-
Distance from Light	1'	2'	3'	4'	5'	6'	7'	8'	9'																																																						
Footcandles	3.2	1.2	.26	-	-	-	-	-	-																																																						
Distance from Light	.5'	1'	2'	3'	4'	5'	6'	7'	8'																																																						
Footcandles	.16	.36	.20	-	-	-	-	-	-																																																						
Distance from Light	1'	2'	3'	4'	5'	6'	7'	8'	9'																																																						
Footcandles	21.1	7.3	1.7	.7	.5	-	-	-	-																																																						

Denotes fixture is compatible with incandescent or LED lamps.

INCANDESCENT / LED 12V HYBRID PATH & SPREAD



15322 AGZ - CROSS CREEK™ LANTERN **15365 CV - LA MESA™ LANTERN** **15458 OZ - MISSION BOLLARD**

Description	Arts and crafts style in a path light for distinctive simplicity. Matching 120V surface and post mount styles available.	Arts and crafts-inspired light complements any architectural style. Matching 120V surface and post mount styles available.	The broad roof indicative of mission styling is blended into a garden bollard with honey beige glass.
Ordering Guide & Finish	15322 AGZ - Aged Bronze	15365 CV - Canyon View™	15458 OZ - Old Bronze®
Housing	Cast Aluminum with textured linen seeded glass panels	Solid Brass with Honey opalescent glass. Glass panel colors may vary due to production methods	Brass with honey beige glass
Lamp Base	12V T5 wedge base socket	12V S8 wedge base socket	12V T5 wedge base socket
Supplied Lamp	16.25-W(VA) 921X (17025) Xenon light source Power usage at 12V AC input VA MAX: 16.25-W(VA)	24.4-W(VA) 3156K (15598 CLR) Krypton light source Power usage at 12V AC input VA MAX: 24.4-W(VA)	11.6-W(VA) 912X (17023) (qty 2) Xenon light source Power usage at 12V AC input VA MAX: 16.25-W(VA)
Incandescent Lamp Options	11.6-W(VA) 921X (17023) 6.5-W(VA) 918X (17022) 4-W(VA) 901X (17021)	18.5-W(VA) 3155K (15599 CLR)	16.25-W(VA) 921X (17025) 6.5-W(VA) 918X (17022) 4-W(VA) 901X (17021) (2 required)
LED Lamp Options	2W (18039-18041) see page 159 Compares up to 16W Xenon	2W (18036-18038) see page 159 Compares up to 18.5W Krypton	2W (18039-18041) see page 159 Compares up to 16W Xenon
Wiring	35" of usable #18-2, SPT-1-W leads Cable connector supplied	21" of usable #18-2, SPT-1-W leads Cable connector supplied	22" of usable #18-2, SPT-1-W leads Cable connector supplied
Mounting Acces. Included	8" In-ground stake	8" In-ground stake	14" In-ground stake
Optional Acces.	15601 - Surface Mounting Flange 15607 - Surface Mounting Bracket	15601 - Surface Mounting Flange 15607 - Surface Mounting Bracket	
Notes	U.S. Patent No. D580,084	U.S. Patent Pending	
Photometric with Supplied Lamp	Distance from Light 0' 1' 2' 3' 4' 5' 6' 7' 8' Footcandles 3.2 1.2 .26 - - - - -	Distance from Light 1' 2' 3' 4' 5' 6' 7' 8' 9' Footcandles 3.2 .5 .03 - - - - -	Distance from Light 0' 1' 2' 3' 4' 5' 6' 7' 8' Footcandles 0.44 1.81 1.26 0.70 0.39 0.25 0.16 0.12 0.10



Denotes fixture is compatible with incandescent or LED lamps.

INCANDESCENT / LED 12V HYBRID PATH & SPREAD



15367 TZT - ROUND LANTERN

15438 OB, OZ - TRADITIONAL MARINE LANTERN

Description	Simple, elegant style blends with traditional or contemporary architecture.	Traditional marine lantern for well-shielded illumination in two finishes. Matching 120V surface and post mount styles.
Ordering Guide & Finish	15367 TZT - Textured Tannery Bronze™	15438 OB - Olde Brick®, Brass 15438 OZ - Olde Bronze®, Brass
Housing	Cast Aluminum with etched sunset glass	Brass with white polycarbonate diffuser
Lamp Base	12V S8 wedge base socket 	12V S8 wedge base socket 
Supplied Lamp	24.4-W(VA) 3156K (15598 CLR) Krypton light source Power usage at 12V AC input VA MAX: 24.4-W(VA)	18.5-W(VA) 3155K (15599 CLR) Krypton light source Power usage at 12V AC input VA MAX: 18.5-W(VA)
Incandescent Lamp Options	18.5-W(VA) 3155K (15599 CLR)	N/A
LED Lamp Options	2W (18036-18038) see page 159 Compares up to 18.5W Krypton	2W (18036-18038) see page 159 Compares up to 18.5W Krypton
Wiring	51" of usable #18-2, SPT-1-W leads. Cable connector supplied	26" of usable #18-2, SPT-1-W leads. Cable connector supplied
Mounting Acces. Included	8" In-ground stake	8" In-ground stake
Optional Acces.	15601 - Surface Mounting Flange 15607 - Surface Mounting Bracket	15601 - Surface Mounting Flange 15607 - Surface Mounting Bracket
Photometric with Supplied Lamp	Distance from Light	Distance from Light
	Footcandles	Footcandles

 Denotes fixture is compatible with incandescent or LED lamps.

INCANDESCENT / LED 12V HYBRID PATH & SPREAD



15450 TZT - MICA MISSION

15352 OZ - TRADITIONAL LANTERN

15334 OB - CONCORD LANTERN

Description	A mission style roof combined with glass designed to replicate the amber glow of mica for a warm comfortable exterior look.	Classic elegance complimented by etched seedy glass	Revolutionary design adds an early colonial flair to formal settings.
Ordering Guide & Finish	15450 TZT - Textured Tannery Bronze™	15352 OZ - Olde Bronze®	15334 OB - Olde Brick®
Housing	Cast Aluminum and mica finished glass	Brass with etched seedy glass	Brass with stainless steel rods and seedy glass
Lamp Base	12V T5 wedge base socket	12V S8 wedge base socket	12V T5 wedge base socket
Supplied Lamp	11.6-W(VA) 912X (17023) Xenon light source Power usage at 12V AC input VA MAX: 16.25-W(VA)	18.5-W(VA) 3155K (15599 CLR) Krypton light source Power usage at 12V AC input VA MAX: 18.5-W(VA)	6.5-W(VA) 918X (17022) Xenon light source Power usage at 12V AC input VA MAX: 6.5-W(VA)
Incandescent Lamp Options	16.25-W(VA) 921X (17025) 6.5-W(VA) 918X (17022) 4-W(VA) 901X (17021)	N/A	4-W(VA) 901X (17022)
LED Lamp Options	N/A	2W (18036-18038) see page 159 Compares up to 18.5W Krypton	2W (18039-18041) see page 159 Compares up to 16W Xenon
Wiring	22" of usable #18-2, SPT-1-W leads Cable connector supplied	24" of usable #18-2, SPT-1-W leads Cable connector supplied	20" of usable #18-2, SPT-1-W leads Cable connector supplied
Mounting Acces. Included	8" In-ground stake	8" In-ground stake	8" In-ground stake
Optional Acces.	15601 - Surface Mounting Flange 15607 - Surface Mounting Bracket	15601 - Surface Mounting Flange 15607 - Surface Mounting Bracket	15601 - Surface Mounting Flange 15607 - Surface Mounting Bracket
Notes	N/A	U.S. Patent No. D420,160	N/A
Photometric with Supplied Lamp	Distance from Light 0' 1' 2' 3' 4' 5' 6' 7' 8' Footcandles 1.34 1.61 1.63 0.86 0.46 0.28 0.07 0.07 -	Distance from Light .5' 1' 2' 3' 4' 5' 6' 7' 8' Footcandles 2.7 1.3 .3 .1 - - - - -	Distance from Light 1' 2' 3' 4' 5' 6' 7' 8' 9' Footcandles 20.9 4.7 .6 .2 - - - - -

Denotes fixture is compatible with incandescent or LED lamps.



INCANDESCENT / LED 12V HYBRID PATH & SPREAD



INCANDESCENT/LED 12V HYBRID PATH & SPREAD

P

Description	Dense purple, deep cranberry red and golden amber glass flowers will seamlessly blend into a flowerbed during the day and provide the punch of light needed in the evening. Mix or match colors or use the special mounting accessory to create an innovative centerpiece with different angles and heights.																				
Ordering Guide & Finish	15435 PP - Olde Bronze® with Dense Purple Glass 15435 RD - Olde Bronze® with Cranberry Red Glass 15435 AMB - Olde Bronze® with Golden Amber Glass																				
Housing	Brass																				
Lamp Base	12V S8 wedge base socket																				
Supplied Lamp	24.4-W(VA) 3156K (15598 CLR) Krypton light source Power usage at 12V AC input VA MAX: 24.4-W(VA)																				
Incandescent Lamp Options	18.5-W(VA) 3155K (15599 CLR)																				
LED Lamp Options	2W (18036-18038) see page 159 Compares up to 18.5W Krypton																				
Wiring	34" of usable #18-2, SPT-1-W leads. Cable connector supplied																				
Mounting Acces. Included	8" In-ground stake																				
Optional Acces.	15635 OZ - Three-Fixture Centerpiece Mounting Kit																				
Photometric with Supplied Lamp	<table border="1" style="width: 100%; border-collapse: collapse;"> <thead> <tr> <th>Distance from Light</th> <th>0'</th> <th>1'</th> <th>2'</th> <th>3'</th> <th>4'</th> <th>5'</th> <th>6'</th> <th>7'</th> <th>8'</th> </tr> </thead> <tbody> <tr> <td>Footcandles</td> <td>4.9</td> <td>3.1</td> <td>3.1</td> <td>1.3</td> <td>0.5</td> <td>0.2</td> <td>-</td> <td>-</td> <td>-</td> </tr> </tbody> </table>	Distance from Light	0'	1'	2'	3'	4'	5'	6'	7'	8'	Footcandles	4.9	3.1	3.1	1.3	0.5	0.2	-	-	-
Distance from Light	0'	1'	2'	3'	4'	5'	6'	7'	8'												
Footcandles	4.9	3.1	3.1	1.3	0.5	0.2	-	-	-												

Denotes fixture is compatible with incandescent or LED lamps.



THREE-FIXTURE CENTERPIECE MOUNTING KIT

The kit allows for the creation of an interesting garden centerpiece that replicates nature with Posies installed at an angle at varying heights. Can also be used to install three fixtures at the same height. Colors may be mixed or uniform. Kit includes a mounting plate, 14" In-ground stake for added stability, a 3" Olde Bronze® stem section and the necessary hardware and instructions to make a truly creative garden feature.







KICHLER®

INCANDESCENT / LED 12V HYBRID PATH & SPREAD



	15317 AZT, BN - GLASS & METAL	15318 AZT - GALAXY																																								
Description	A sleek, modern original that combines contemporary style with smooth illumination.	Sophisticated, modern style in an understated fixture.																																								
Ordering Guide & Finish	15317 BN - Brushed Nickel 15317 AZT - Textured Architectural Bronze	15318 AZT - Textured Architectural Bronze																																								
Housing	Aluminum (AZT) or Brass (BN) with glass diffuser	Aluminum																																								
Lamp Base	12V S8 wedge base socket 	12V S8 wedge base socket 																																								
Supplied Lamp	24.4-W(VA) 3156K (15598 CLR) Krypton light source Power usage at 12V AC input VA MAX: 24.4-W(VA)	24.4-W(VA) 3156K (15598 CLR) Krypton light source Power usage at 12V AC input VA MAX: 24.4-W(VA)																																								
Incandescent Lamp Options	18.5-W(VA) 3155K (15599 CLR)	18.5-W(VA) 3155K (15599 CLR)																																								
LED Lamp Options	2W (18036-18038) see page 159 Compares up to 18.5W Krypton	2W (18036-18038) see page 159 Compares up to 18.5W Krypton																																								
Wiring	35" of usable #18-2, SPT-1-W leads. Cable connector supplied	35" of usable #18-2, SPT-1-W leads. Cable connector supplied																																								
Mounting Acces. Included	8" In-ground stake	8" In-ground stake																																								
Optional Acces.	15601 – Surface Mounting Flange 15607 – Surface Mounting Bracket	15601 – Surface Mounting Flange 15607 – Surface Mounting Bracket																																								
Integrated LED Options	15817 – on Page 14	NA																																								
Notes	U.S. Patent No. D406,374	NA																																								
Photometric with Supplied Lamp	<table border="1"> <tr> <td>Distance from Light</td> <td>1'</td> <td>2'</td> <td>3'</td> <td>4'</td> <td>5'</td> <td>6'</td> <td>7'</td> <td>8'</td> <td>9'</td> </tr> <tr> <td>Footcandles</td> <td>9.4</td> <td>4.8</td> <td>2</td> <td>.72</td> <td>.32</td> <td>.16</td> <td>-</td> <td>-</td> <td>-</td> </tr> </table>	Distance from Light	1'	2'	3'	4'	5'	6'	7'	8'	9'	Footcandles	9.4	4.8	2	.72	.32	.16	-	-	-	<table border="1"> <tr> <td>Distance from Light</td> <td>1'</td> <td>2'</td> <td>3'</td> <td>4'</td> <td>5'</td> <td>6'</td> <td>7'</td> <td>8'</td> <td>9'</td> </tr> <tr> <td>Footcandles</td> <td>2.6</td> <td>3.2</td> <td>1.2</td> <td>.5</td> <td>.2</td> <td>-</td> <td>-</td> <td>-</td> <td>-</td> </tr> </table>	Distance from Light	1'	2'	3'	4'	5'	6'	7'	8'	9'	Footcandles	2.6	3.2	1.2	.5	.2	-	-	-	-
Distance from Light	1'	2'	3'	4'	5'	6'	7'	8'	9'																																	
Footcandles	9.4	4.8	2	.72	.32	.16	-	-	-																																	
Distance from Light	1'	2'	3'	4'	5'	6'	7'	8'	9'																																	
Footcandles	2.6	3.2	1.2	.5	.2	-	-	-	-																																	

 Denotes fixture is compatible with incandescent or LED lamps.

INCANDESCENT / LED 12V HYBRID PATH & SPREAD



15360 AZT - SIMPLICITY SIDE MOUNT

15333 TZT - CONTOURS

Description	Simple, uncomplicated design for perfect illumination along paths without troublesome glare.	A fresh interpretation of contemporary style. Equally effective as a path light or to highlight a flower bed.																																								
Ordering Guide & Finish	15360 AZT - Textured Architectural Bronze	15333 TZT - Textured Tannery Bronze																																								
Housing	Aluminum	Aluminum																																								
Lamp Base	12V S8 wedge base socket	12V S8 wedge base socket																																								
Supplied Lamp	24.4-W(VA) 3156K (15598 CLR) Krypton light source Power usage at 12V AC input VA MAX: 24.4-W(VA)	24.4-W(VA) 3156K (15598 CLR) Krypton light source Power usage at 12V AC input VA MAX: 24.4-W(VA)																																								
Incandescent Lamp Options	18.5-W(VA) 3155K (15599 CLR)	18.5-W(VA) 3155K (15599 CLR)																																								
LED Lamp Options	2W (18036-18038) see page 159 Compares up to 18.5W Krypton	2W (18036-18038) see page 159 Compares up to 18.5W Krypton																																								
Wiring	35" of usable #18-2, SPT-1-W leads. Cable connector supplied	34" of usable #18-2, SPT-1-W leads. Cable connector supplied																																								
Mounting Acces. Included	8" In-ground stake	8" In-ground stake																																								
Optional Acces.	15601 - Surface Mounting Flange 15607 - Surface Mounting Bracket	15601 - Surface Mounting Flange 15607 - Surface Mounting Bracket																																								
Notes	N/A	U.S. Patent Pending																																								
Photometric with Supplied Lamp	<table border="1"> <tr> <td>Distance from Light</td> <td>.5'</td> <td>1'</td> <td>2'</td> <td>3'</td> <td>4'</td> <td>5'</td> <td>6'</td> <td>7'</td> <td>8'</td> </tr> <tr> <td>Footcandles</td> <td>20.7</td> <td>10.6</td> <td>3.5</td> <td>1.1</td> <td>.4</td> <td>.1</td> <td>-</td> <td>-</td> <td>-</td> </tr> </table>	Distance from Light	.5'	1'	2'	3'	4'	5'	6'	7'	8'	Footcandles	20.7	10.6	3.5	1.1	.4	.1	-	-	-	<table border="1"> <tr> <td>Distance from Light</td> <td>1'</td> <td>2'</td> <td>3'</td> <td>4'</td> <td>5'</td> <td>6'</td> <td>7'</td> <td>8'</td> <td>9'</td> </tr> <tr> <td>Footcandles</td> <td>11.9</td> <td>6.6</td> <td>2.58</td> <td>.88</td> <td>.28</td> <td>-</td> <td>-</td> <td>-</td> <td>-</td> </tr> </table>	Distance from Light	1'	2'	3'	4'	5'	6'	7'	8'	9'	Footcandles	11.9	6.6	2.58	.88	.28	-	-	-	-
Distance from Light	.5'	1'	2'	3'	4'	5'	6'	7'	8'																																	
Footcandles	20.7	10.6	3.5	1.1	.4	.1	-	-	-																																	
Distance from Light	1'	2'	3'	4'	5'	6'	7'	8'	9'																																	
Footcandles	11.9	6.6	2.58	.88	.28	-	-	-	-																																	

Denotes fixture is compatible with incandescent or LED lamps.

INCANDESCENT / LED 12V HYBRID PATH & SPREAD



15439 CO, OB, OB6, TZT - FUNDAMENTALS™

15328 AZT - LARGE CENTER MOUNT

Description	Basic, uncomplicated design for versatility. Use along walkways or points of interest. Now with a heavier gauge shade.	Wide head for broad light spread to highlight beds and paths. Textured Architectural Bronze finish blends with landscape.
Ordering Guide & Finish	15439 CO - Polished Copper, Copper 15439 OB - Olde Brick®, Brass 15439 OB6 - Same as 15439 OB. Bulk packed in 6 (unbreakable master). 15439 TZT - Textured Tannery Bronze™, Brass	15328 AZT - Textured Architectural Bronze
Housing	Brass or Unfinished Copper. Copper will naturally patina over time.	Aluminum
Lamp Base	12V S8 wedge base socket	12V S8 wedge base socket
Supplied Lamp	24.4-W(VA) 3156K (15598 CLR) Krypton light source Power usage at 12V AC input VA MAX: 24.4-W(VA)	24.4-W(VA) 3156K (15598 CLR) Krypton light source Power usage at 12V AC input VA MAX: 24.4-W(VA)
Incandescent Lamp Options	18.5-W(VA) 3155K (15599 CLR)	18.5-W(VA) 3155K (15599 CLR)
LED Lamp Options	2W (18036-18038) see page 159 Compares up to 18.5W Krypton	2W (18036-18038) see page 159 Compares up to 18.5W Krypton
Wiring	35" of usable #18-2, SPT-1-W leads. Cable connector supplied	35" of usable #18-2, SPT-1-W leads. Cable connector supplied
Mounting Acces. Included	8" In-ground stake	8" In-ground stake and 18" stem
Optional Acces.	15601 - Surface Mounting Flange 15607 - Surface Mounting Bracket	15601 - Surface Mounting Flange 15607 - Surface Mounting Bracket
Integrated LED Options	15839 - on Page 11	NA
Photometric with Supplied Lamp	Distance from Light	0' 1' 2' 3' 4' 5' 6' 7' 8'
	Footcandles	13.4 4.55 1.65 .58 .13 - - - -
	Stem Height	1' 2' 3' 4' 5' 6' 7' 8' 9'
	12"	20.8 4.1 .27 - - - - -
18** (as supplied)	12.1 5.6 1.8 .67 - - - - -	
24"	8.3 5.8 2.2 .97 .48 .02 - - -	

Denotes fixture is compatible with incandescent or LED lamps.

INCANDESCENT / LED 12V HYBRID PATH & SPREAD



15005 AZT, BKT - FUNDAMENTALS™

15315 AZT, AZT6, BE, BKT - SIDE MOUNT

Description	Louvers direct tiers of light downward for well-shielded, dramatic lighting. Blends nicely with shrubs or flowers along a pathway. Available in stem or deck mount or as a bollard. Mounting stems and bollard kits sold separately. Coordinates with matching deck light 15065 on page 109.	A popular design in a side-mount fixture for more directional lighting without glare. Coordinates with matching deck light 15065 on page 109.																																																																																
Ordering Guide & Finish	15005 AZT - Textured Architectural Bronze 15005 BKT - Textured Black	15315 AZT - Textured Architectural Bronze 15315 AZT6 - Same as 15315 AZT. Bulk packed in 6 (unbreakable master) 15315 BKT - Textured Black																																																																																
Housing	Cast Aluminum with molded ribbed diffuser of clear UV stabilized high impact resistant polycarbonate	Cast Aluminum																																																																																
Lamp Base	12V S8 wedge base socket	12V S8 wedge base socket																																																																																
Supplied Lamp	24.4-W(VA) 3156K (15598 CLR) Krypton light source Power usage at 12V AC input VA MAX: 24.4-W(VA)	24.4-W(VA) 3156K (15598 CLR) Krypton light source Power usage at 12V AC input VA MAX: 24.4-W(VA)																																																																																
Incandescent Lamp Options	18.5-W(VA) 3155K (15599 CLR)	18.5-W(VA) 3155K (15599 CLR)																																																																																
LED Lamp Options	2W (18036-18038) see page 159 Compares up to 18.5W Krypton	2W (18036-18038) see page 159 Compares up to 18.5W Krypton																																																																																
Wiring	52" of usable #18-2, SPT-1-W leads. Cable connector supplied	35" of usable #18-2, SPT-1-W leads. Cable connector supplied																																																																																
Mounting Acces. Included	NA	8" In-ground stake and 18" stem																																																																																
Optional Acces.	15656, 15657, 15658 or 15570 - Stems 15575 BK, 15576 BK or 15578 - Stakes 15665, 15666 or 15667 - Bollard 15671 ST - Bollard Template Kit 15601 - Surface Mounting Flange 15602 - Flange Mounting Nipple 15607 - Surface Mounting Bracket	15601 - Surface Mounting Flange 15607 - Surface Mounting Bracket																																																																																
Integrated LED Option	NA	15815 - on Page 15																																																																																
Photometric with Supplied Lamp	<table border="1"> <thead> <tr> <th>Stem Height</th> <th>1'</th> <th>2'</th> <th>3'</th> <th>4'</th> <th>5'</th> <th>6'</th> <th>7'</th> <th>8'</th> <th>9'</th> </tr> </thead> <tbody> <tr> <td>12"</td> <td>2.1</td> <td>.93</td> <td>.67</td> <td>.18</td> <td>-</td> <td>-</td> <td>-</td> <td>-</td> <td>-</td> </tr> <tr> <td>18"</td> <td>1.8</td> <td>.73</td> <td>.4</td> <td>.27</td> <td>0.3</td> <td>-</td> <td>-</td> <td>-</td> <td>-</td> </tr> <tr> <td>24"</td> <td>1.2</td> <td>.67</td> <td>.33</td> <td>.35</td> <td>.27</td> <td>.15</td> <td>-</td> <td>-</td> <td>-</td> </tr> </tbody> </table>	Stem Height	1'	2'	3'	4'	5'	6'	7'	8'	9'	12"	2.1	.93	.67	.18	-	-	-	-	-	18"	1.8	.73	.4	.27	0.3	-	-	-	-	24"	1.2	.67	.33	.35	.27	.15	-	-	-	<table border="1"> <thead> <tr> <th>Stem Height</th> <th>1'</th> <th>2'</th> <th>3'</th> <th>4'</th> <th>5'</th> <th>6'</th> <th>7'</th> <th>8'</th> <th>9'</th> </tr> </thead> <tbody> <tr> <td>12"</td> <td>18.7</td> <td>4.3</td> <td>1.4</td> <td>.27</td> <td>-</td> <td>-</td> <td>-</td> <td>-</td> <td>-</td> </tr> <tr> <td>18" (as supplied)</td> <td>15</td> <td>5.2</td> <td>1.8</td> <td>.8</td> <td>.27</td> <td>.03</td> <td>-</td> <td>-</td> <td>-</td> </tr> <tr> <td>24"</td> <td>11.6</td> <td>5.1</td> <td>2.2</td> <td>.97</td> <td>.48</td> <td>.2</td> <td>.07</td> <td>-</td> <td>-</td> </tr> </tbody> </table>	Stem Height	1'	2'	3'	4'	5'	6'	7'	8'	9'	12"	18.7	4.3	1.4	.27	-	-	-	-	-	18" (as supplied)	15	5.2	1.8	.8	.27	.03	-	-	-	24"	11.6	5.1	2.2	.97	.48	.2	.07	-	-
Stem Height	1'	2'	3'	4'	5'	6'	7'	8'	9'																																																																									
12"	2.1	.93	.67	.18	-	-	-	-	-																																																																									
18"	1.8	.73	.4	.27	0.3	-	-	-	-																																																																									
24"	1.2	.67	.33	.35	.27	.15	-	-	-																																																																									
Stem Height	1'	2'	3'	4'	5'	6'	7'	8'	9'																																																																									
12"	18.7	4.3	1.4	.27	-	-	-	-	-																																																																									
18" (as supplied)	15	5.2	1.8	.8	.27	.03	-	-	-																																																																									
24"	11.6	5.1	2.2	.97	.48	.2	.07	-	-																																																																									

Denotes fixture is compatible with incandescent or LED lamps.

INCANDESCENT / LED 12V HYBRID PATH & SPREAD



	15326 AZT, AZT6, BKT - CENTER MOUNT	15011 AZT, BKT - ONE TIER																																																																																
Description	Unobtrusive, center mount fixture for maximum light spread. Coordinates with matching deck light 15065 on page 109.	Versatile fixture with wider light distribution for paths and low areas of groundcover. Louver inverts to create more indirect light spread. Mounting stems and bollard kits sold separately. Coordinates with matching deck light 15065 on page 109																																																																																
Ordering Guide & Finish	15326 AZT - Textured Architectural Bronze 15326 AZT6 - Same as 15326 AZT. Bulk packed in 6 (unbreakable master) 15326 BKT - Textured Black	15011 AZT - Textured Architectural Bronze 15011 BKT - Textured Black																																																																																
Housing	Cast Aluminum	Cast Aluminum with molded ribbed diffuser of clear UV stabilized high impact resistant polycarbonate																																																																																
Lamp Base	12V S8 wedge base socket	12V S8 wedge base socket																																																																																
Supplied Lamp	24.4-W(VA) 3156K (15598 CLR) Krypton light source Power usage at 12V AC input VA MAX: 24.4-W(VA)	24.4-W(VA) 3156K (15598 CLR) Krypton light source Power usage at 12V AC input VA MAX: 24.4-W(VA)																																																																																
Incandescent Lamp Options	18.5-W(VA) 3155K (15599 CLR)	18.5-W(VA) 3155K (15599 CLR)																																																																																
LED Lamp Options	2W (18036-18038) see page 159 Compares up to 18.5W Krypton	2W (18036-18038) see page 159 Compares up to 18.5W Krypton																																																																																
Wiring	35" of usable #18-2, SPT-1-W leads. Cable connector supplied	52" of usable #18-2, SPT-1-W leads. Cable connector supplied																																																																																
Mounting Acces. Included	8" In-ground stake and 18" stem	NA																																																																																
Optional Acces.	15601 - Surface Mounting Flange 15607 - Surface Mounting Bracket	15656, 15657, 15658 or 15570 - Stems 15575 BK, 15576 or 15578 BK - Stakes 15665, 15666 or 15667 - Bollard 15671 ST - Bollard Template Kit 15601 - Surface Mounting Flange 15602 - Flange Mounting Nipple 15607 - Surface Mounting Bracket																																																																																
Integrated LED Option	15826 - on Page 16	NA																																																																																
Photometric with Supplied Lamp	<table border="1"> <thead> <tr> <th>Stem Height</th> <th>1'</th> <th>2'</th> <th>3'</th> <th>4'</th> <th>5'</th> <th>6'</th> <th>7'</th> <th>8'</th> <th>9'</th> </tr> </thead> <tbody> <tr> <td>12"</td> <td>21.8</td> <td>5.3</td> <td>1.5</td> <td>.1</td> <td>-</td> <td>-</td> <td>-</td> <td>-</td> <td>-</td> </tr> <tr> <td>18" (as supplied)</td> <td>16.6</td> <td>6.3</td> <td>2.2</td> <td>.87</td> <td>.1</td> <td>-</td> <td>-</td> <td>-</td> <td>-</td> </tr> <tr> <td>24"</td> <td>7.9</td> <td>6.1</td> <td>2.7</td> <td>1.2</td> <td>.55</td> <td>.2</td> <td>-</td> <td>-</td> <td>-</td> </tr> </tbody> </table>	Stem Height	1'	2'	3'	4'	5'	6'	7'	8'	9'	12"	21.8	5.3	1.5	.1	-	-	-	-	-	18" (as supplied)	16.6	6.3	2.2	.87	.1	-	-	-	-	24"	7.9	6.1	2.7	1.2	.55	.2	-	-	-	<table border="1"> <thead> <tr> <th>Stem Height</th> <th>1'</th> <th>2'</th> <th>3'</th> <th>4'</th> <th>5'</th> <th>6'</th> <th>7'</th> <th>8'</th> <th>9'</th> </tr> </thead> <tbody> <tr> <td>12"</td> <td>6.9</td> <td>1.8</td> <td>1.1</td> <td>.13</td> <td>-</td> <td>-</td> <td>-</td> <td>-</td> <td>-</td> </tr> <tr> <td>18"</td> <td>5.3</td> <td>1.8</td> <td>.9</td> <td>.68</td> <td>.13</td> <td>-</td> <td>-</td> <td>-</td> <td>-</td> </tr> <tr> <td>24"</td> <td>4.1</td> <td>1.9</td> <td>.75</td> <td>.62</td> <td>.43</td> <td>.13</td> <td>-</td> <td>-</td> <td>-</td> </tr> </tbody> </table>	Stem Height	1'	2'	3'	4'	5'	6'	7'	8'	9'	12"	6.9	1.8	1.1	.13	-	-	-	-	-	18"	5.3	1.8	.9	.68	.13	-	-	-	-	24"	4.1	1.9	.75	.62	.43	.13	-	-	-
Stem Height	1'	2'	3'	4'	5'	6'	7'	8'	9'																																																																									
12"	21.8	5.3	1.5	.1	-	-	-	-	-																																																																									
18" (as supplied)	16.6	6.3	2.2	.87	.1	-	-	-	-																																																																									
24"	7.9	6.1	2.7	1.2	.55	.2	-	-	-																																																																									
Stem Height	1'	2'	3'	4'	5'	6'	7'	8'	9'																																																																									
12"	6.9	1.8	1.1	.13	-	-	-	-	-																																																																									
18"	5.3	1.8	.9	.68	.13	-	-	-	-																																																																									
24"	4.1	1.9	.75	.62	.43	.13	-	-	-																																																																									

Denotes fixture is compatible with incandescent or LED lamps.

INCANDESCENT / LED 12V HYBRID PATH & SPREAD

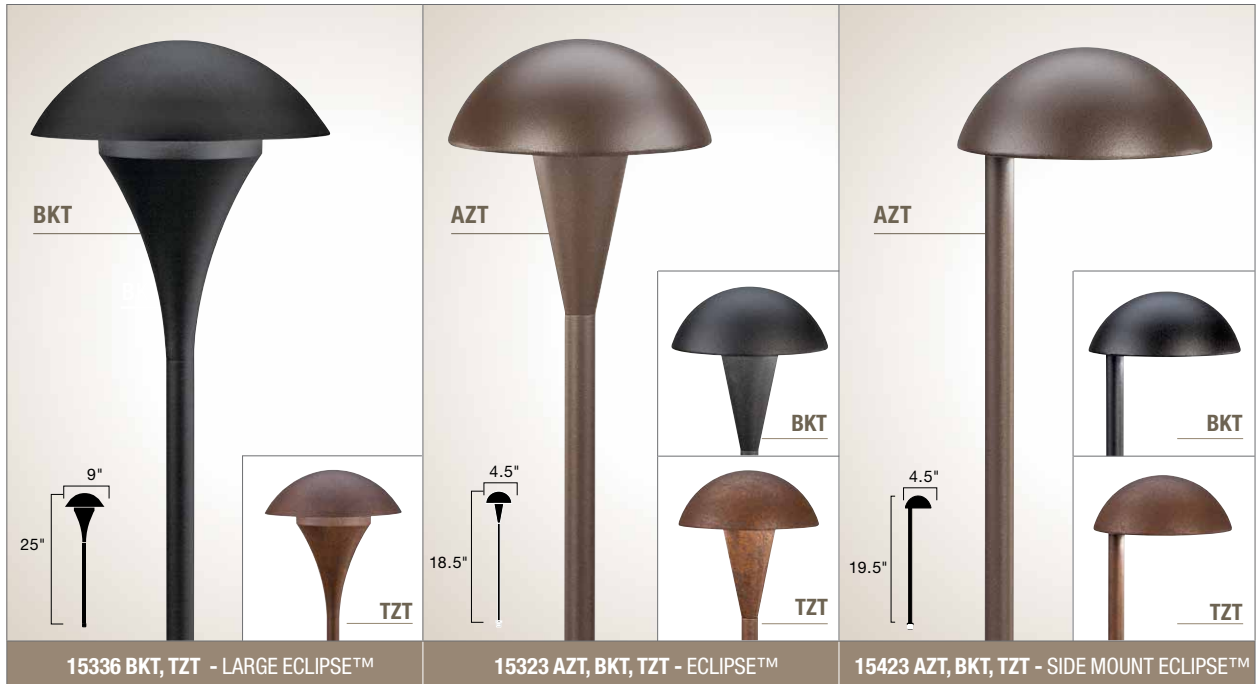

	15336 BKT, Tzt - LARGE ECLIPSE™	15323 AZT, BKT, Tzt - ECLIPSE™	15423 AZT, BKT, Tzt - SIDE MOUNT ECLIPSE™																																																												
Description	A larger version of our popular Eclipse design to cast a wider light spread on a wide path or patio.	A smaller scale, contemporary design with a dome cap that creates a soft, warm circular glow of light.	Popular dome cap design in a side-mounted fixture for more directional lighting.																																																												
Ordering Guide & Finish	15336 BKT - Textured Black 15336 Tzt - Textured Tannery Bronze™	15323 AZT - Textured Architectural Bronze 15323 BKT - Textured Black 15323 Tzt - Textured Tannery Bronze™	15423 AZT - Textured Architectural Bronze 15423 BKT - Textured Black 15423 Tzt - Textured Tannery Bronze™																																																												
Housing	Cast Aluminum with clear glass	Cast Aluminum	Cast Aluminum																																																												
Lamp Base	12V S8 wedge base socket	12V S8 wedge base socket	12V S8 wedge base socket																																																												
Supplied Lamp	24.4-W(VA) 3156K (15598 CLR) Krypton light source Power usage at 12V AC input VA MAX: 24.4-W(VA)	24.4-W(VA) 3156K (15598 CLR) Krypton light source Power usage at 12V AC input VA MAX: 24.4-W(VA)	24.4-W(VA) 3156K (15598 CLR) Krypton light source Power usage at 12V AC input VA MAX: 24.4-W(VA)																																																												
Incandescent Lamp Options	18.5-W(VA) 3155K (15599 CLR)	18.5-W(VA) 3155K (15599 CLR)	18.5-W(VA) 3155K (15599 CLR)																																																												
LED Lamp Options	2W (18036-18038) see page 159 Compares up to 18.5W Krypton	2W (18036-18038) see page 159 Compares up to 18.5W Krypton	2W (18036-18038) see page 159 Compares up to 18.5W Krypton																																																												
Wiring	35" of usable #18-2, SPT-1-W leads Cable connector supplied	37" of usable #18-2, SPT-1-W leads Cable connector supplied	34" of usable #18-2, SPT-1-W leads Cable connector supplied																																																												
Mounting Acces. Included	8" In-ground stake	8" In-ground stake	8" In-ground stake																																																												
Optional Acces.	15601 - Surface Mounting Flange 15607 - Surface Mounting Bracket	15601 - Surface Mounting Flange 15607 - Surface Mounting Bracket	15601 - Surface Mounting Flange 15607 - Surface Mounting Bracket																																																												
Photometric with Supplied Lamp	<table border="1"> <tr> <td>Distance from Light</td> <td>1'</td><td>2'</td><td>3'</td><td>4'</td><td>5'</td><td>6'</td><td>7'</td><td>8'</td><td>9'</td> </tr> <tr> <td>Footcandles</td> <td>8.7</td><td>3.3</td><td>1.1</td><td>.4</td><td>.1</td><td>-</td><td>-</td><td>-</td><td>-</td> </tr> </table>	Distance from Light	1'	2'	3'	4'	5'	6'	7'	8'	9'	Footcandles	8.7	3.3	1.1	.4	.1	-	-	-	-	<table border="1"> <tr> <td>Distance from Light</td> <td>1'</td><td>2'</td><td>3'</td><td>4'</td><td>5'</td><td>6'</td><td>7'</td><td>8'</td><td>9'</td> </tr> <tr> <td>Footcandles</td> <td>14.7</td><td>4.8</td><td>1.8</td><td>1</td><td>-</td><td>-</td><td>-</td><td>-</td><td>-</td> </tr> </table>	Distance from Light	1'	2'	3'	4'	5'	6'	7'	8'	9'	Footcandles	14.7	4.8	1.8	1	-	-	-	-	-	<table border="1"> <tr> <td>Distance from Light</td> <td>0'</td><td>1'</td><td>2'</td><td>3'</td><td>4'</td><td>5'</td><td>6'</td><td>7'</td><td>8'</td> </tr> <tr> <td>Footcandles</td> <td>44.3</td><td>18.6</td><td>5.7</td><td>1.8</td><td>.3</td><td>.2</td><td>-</td><td>-</td><td>-</td> </tr> </table>	Distance from Light	0'	1'	2'	3'	4'	5'	6'	7'	8'	Footcandles	44.3	18.6	5.7	1.8	.3	.2	-	-	-
Distance from Light	1'	2'	3'	4'	5'	6'	7'	8'	9'																																																						
Footcandles	8.7	3.3	1.1	.4	.1	-	-	-	-																																																						
Distance from Light	1'	2'	3'	4'	5'	6'	7'	8'	9'																																																						
Footcandles	14.7	4.8	1.8	1	-	-	-	-	-																																																						
Distance from Light	0'	1'	2'	3'	4'	5'	6'	7'	8'																																																						
Footcandles	44.3	18.6	5.7	1.8	.3	.2	-	-	-																																																						

Denotes fixture is compatible with incandescent or LED lamps.

INCANDESCENT/LED 12V HYBRID PATH & SPREAD

P



15310 AZT, AZT6, BE, BKT - DOME PATH LIGHT

Description	A wider path and spread light that is unobtrusive in the landscape. Coordinates with our 15410 & 15470 Domed Roof series.
Ordering Guide & Finish	15310 AZT - Textured Architectural Bronze 15310 AZT6 - Same as 15310 AZT. Bulk packed in 6 (unbreakable master) 15310 BE - Beach 15310 BKT - Textured Black
Housing	Cast Aluminum
Lamp Base	12V T5 wedge base socket 
Supplied Lamp	16.25-W(VA) 921X (17025) Xenon light source Power usage at 12V AC input VA MAX: 16.25-W(VA)
Incandescent Lamp Options	11.6-W(VA) 912X (17023) 6.5-W(VA) 918X (17022) 4-W(VA) 901X (17021)
LED Lamp Options	2W (18039-18041) see page 159 Compares up to 16W Xenon
Wiring	24" of usable #18-2, SPT-1-W leads. Cable connector supplied
Mounting Acces. Included	8" In-ground stake
Optional Acces.	15601 - Surface Mounting Flange 15607 - Surface Mounting Bracket
Integrated LED Options	15810 - on Page 17
Photometric with Supplied Lamp	Distance from Light 1' 2' 3' 4' 5' 6' 7' 8' 9'
	Footcandles 8 4.1 1.6 .5 .4 .1 - - -



 Denotes fixture is compatible with incandescent or LED lamps.

INCANDESCENT / LED 12V HYBRID PATH & SPREAD



INCANDESCENT/LED 12V HYBRID PATH & SPREAD

P

	15410 AZT, BE - DOME PATH LIGHT	15470 AZT, BBR, BE, BKT - 6" DOME PATH LIGHT																																								
Description	A shorter version of our popular 15310 designed for use with lower planting and smaller garden areas. Coordinates with our 15310 & 15470 Domed Roof series.	A popular look with a smaller 6" shade. Coordinates with our 15310 & 15410 Domed Roof series.																																								
Ordering Guide & Finish	15410 AZT - Textured Architectural Bronze 15410 BE - Beach	15470 AZT - Textured Architectural Bronze 15470 BBR - Bronzed Brass 15470 BE - Beach 15470 BKT - Textured Black																																								
Housing	Cast Aluminum	Cast Aluminum, Cast Brass																																								
Lamp Base	12V T5 wedge base socket 	12V T5 wedge base socket 																																								
Supplied Lamp	16.25-W(VA) 921X (17025) Xenon light source Power usage at 12V AC input VA MAX: 16.25-W(VA)	16.25-W(VA) 921X (17025) Xenon light source Power usage at 12V AC input VA MAX: 16.25-W(VA)																																								
Incandescent Lamp Options	11.6-W(VA) 912X (17023) 6.5-W(VA) 918X (17022) 4-W(VA) 901X (17021)	11.6-W(VA) 912X (17023) 6.5-W(VA) 918X (17022) 4-W(VA) 901X (17021)																																								
LED Lamp Options	2W (18039-18041) see page 159 Compares up to 16W Xenon	2W (18039-18041) see page 159 Compares up to 16W Xenon																																								
Wiring	30" of usable #18-2, SPT-1-W leads. Cable connector supplied	24" of usable #18-2, SPT-1W leads. Cable connector supplied																																								
Mounting Acces. Included	8" In-ground stake	8" In-ground stake																																								
Optional Acces.	15601 - Surface Mounting Flange 15607 - Surface Mounting Bracket	15601 - Surface Mounting Flange 15607 - Surface Mounting Bracket																																								
Integrated LED Option	15811 - on Page 17	15870 - on Page 16																																								
Photometric with Supplied Lamp	<table border="1"> <tr> <td>Distance from Light</td> <td>0'</td><td>1'</td><td>2'</td><td>3'</td><td>4'</td><td>5'</td><td>6'</td><td>7'</td><td>8'</td> </tr> <tr> <td>Footcandles</td> <td>22.0</td><td>9.6</td><td>4.0</td><td>1.1</td><td>.03</td><td>0.1</td><td>-</td><td>-</td><td>-</td> </tr> </table>	Distance from Light	0'	1'	2'	3'	4'	5'	6'	7'	8'	Footcandles	22.0	9.6	4.0	1.1	.03	0.1	-	-	-	<table border="1"> <tr> <td>Distance from Light</td> <td>0'</td><td>1'</td><td>2'</td><td>3'</td><td>4'</td><td>5'</td><td>6'</td><td>7'</td><td>8'</td> </tr> <tr> <td>Footcandles</td> <td>6.17</td><td>4.85</td><td>4.34</td><td>2.51</td><td>1.58</td><td>1.35</td><td>0.77</td><td>0.43</td><td>0.28</td> </tr> </table>	Distance from Light	0'	1'	2'	3'	4'	5'	6'	7'	8'	Footcandles	6.17	4.85	4.34	2.51	1.58	1.35	0.77	0.43	0.28
Distance from Light	0'	1'	2'	3'	4'	5'	6'	7'	8'																																	
Footcandles	22.0	9.6	4.0	1.1	.03	0.1	-	-	-																																	
Distance from Light	0'	1'	2'	3'	4'	5'	6'	7'	8'																																	
Footcandles	6.17	4.85	4.34	2.51	1.58	1.35	0.77	0.43	0.28																																	

 Denotes fixture is compatible with incandescent or LED lamps.

Incandescent / LED 12V Hybrid Specialty

Fashion meets innovation.



INCANDESCENT/LED 12V HYBRID SPECIALTY



15409 OZ - ZEN GARDEN™ 12V OUTDOOR CHANDELIER

15402 OZ - OAK TRAIL™ 12V OUTDOOR CHANDELIER

Description	This minimal, arts and crafts design illuminates outdoors where weather exposure becomes an issue. Brass will patina over time if unprotected but will resist corrosion. Subtle contemporary Asian style accents any backyard room for sophisticated exterior designers. Pull chain switch allows easy on/off at the light source, even when tied to a larger 12V design layout. Suitable for wet locations. Matching path light available on page 84.	Rugged lodge design with candle-style lights to illuminate pergolas, gazebos or outdoor cooking and dining areas. Suitable for wet locations.																				
Ordering Guide & Finish	15409 OZ - Olde Bronze®	15402 OZ - Olde Bronze®																				
Housing	Brass. Textured amber seedy linen glass.	Brass. Beige glass candle with clear top, candle-drip trim.																				
Lamp Base	12V T5 wedge base socket	12V T5 wedge base sockets																				
Supplied Lamp	16.25-W(VA) 921X (17025) (4 required and supplied) Xenon light source Power usage at 12V AC input VA MAX: 16.25-W(VA)	11.6-W(VA) 918X (17023) (9 required and supplied) Xenon light source Power usage at 12V AC input VA MAX: 11.6-W(VA)																				
Incandescent Lamp Options	11.6-W(VA) 912X (17023) (4 required) 6.5-W(VA) 918X (17022) (4 required) 4-W(VA) 901X (17021) (4 required)	6.5-W(VA) 912X (17022) (9 required)																				
LED Lamp Options	2W (18039-18041) see page 159 Compares up to 16W Xenon	2W (18039-18041) see page 159 Compares up to 16W Xenon																				
Wiring	42" of usable #16-2, SPT-2W leads	42" of usable #16-2, SPT-1-W leads																				
Mounting Acces. Included	(2) 12" extensions and (2) 6" extensions	(2) 12" extensions and (2) 6" extensions																				
Notes	N/A	U.S. Patent Pending																				
Photometric with Supplied Lamp	<table border="1"> <tr> <td>Distance from Light</td> <td>1'</td> <td>2'</td> <td>3'</td> <td>4'</td> <td>5'</td> <td>6'</td> <td>7'</td> <td>8'</td> <td>9'</td> </tr> <tr> <td>Footcandles</td> <td>1.2</td> <td>1.2</td> <td>.9</td> <td>.4</td> <td>.3</td> <td>.1</td> <td>-</td> <td>-</td> <td>-</td> </tr> </table>	Distance from Light	1'	2'	3'	4'	5'	6'	7'	8'	9'	Footcandles	1.2	1.2	.9	.4	.3	.1	-	-	-	N/A
Distance from Light	1'	2'	3'	4'	5'	6'	7'	8'	9'													
Footcandles	1.2	1.2	.9	.4	.3	.1	-	-	-													
		N/A																				

Denotes fixture is compatible with incandescent or LED lamps.

INCANDESCENT/LED 12V HYBRID SPECIALTY



15415 TZT - CATHEDRAL™ LIGHT RAISED PLANTER

15123 BK - MR11 BARBECUE LIGHT

Description	A tall planter that will allow draped foliage to interplay with the light emitting from within the arched interwoven bands.	Integrated surface mount BBQ light for direct connection to 12V landscape lighting system for rail or outdoor countertop mount only.
Ordering Guide & Finish	15415 TZT - Textured Tannery Bronze™	15123 BK - Black
Housing	Aluminum	Components of durable high heat thermoplastic resin. Lamp shielded by a high heat-resistant flat glass lens sealed for watertight outdoor use. Flexible stem is durable chrome plated steel with heat shrink rubber sleeving. On/off switch is protected by waterproof rubber boot.
Lamp Base	12V T5 wedge base socket 	12V bi-pin, high temperature porcelain socket
Supplied Lamp	16.25-W(VA) 921X (17025) Xenon light source Power usage at 12V AC input VA MAX: 16.25-W(VA)	35-W(VA) MR-11 Halogen light source Power usage at 12V AC input VA MAX: 35-W(VA)
Incandescent Lamp Options	11.6-W(VA) 912X (17023) 6.5-W(VA) 918X (17022) 4-W(VA) 901X (17021)	N/A
LED Lamp Options	2W (18039-18041) see page 159 Compares up to 16W Xenon	N/A
Wiring	27' of usable #18-2, SPT-1-W leads. Cable connector supplied	25' of usable #18-2, SPT-1-W leads. Connector supplied
Mounting Acces. Included	14" In-ground stake	(1) set wood screws and (1) set machine screws and nuts
Photometric with Supplied Lamp	Distance from Light .6' 1' 2' 3' 4' 5' 6' 7' 8'	N/A
	Footcandles 8.87 5.16 1.11 1.84 1.14 0.69 0.46 0.34 0.25	N/A

 Denotes fixture is compatible with incandescent or LED lamps.



KICHLER®

Incandescent / LED 12V Hybrid Deck & Patio

Bring outdoor living areas into the light.

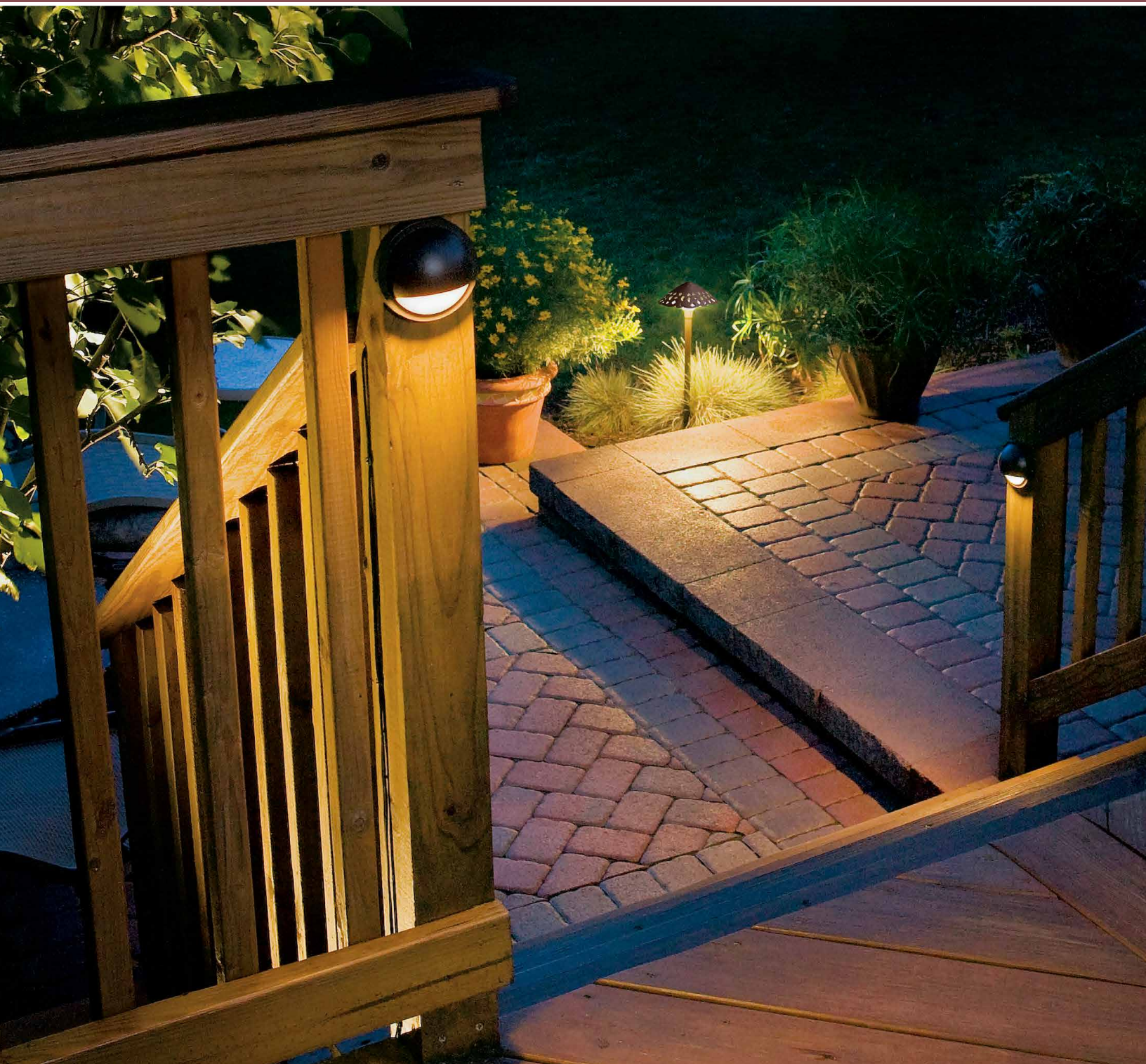



INCANDESCENT/LED 12V HYBRID DECK & PATIO



15047 OZ - OAK TRAIL™ ACCENT LIGHT

15461 AZT - THATCHED ROOF DECK LIGHT

Description	Heavy duty, solid brass lizard to accent decks, breakwalls or other interest points. Patinas over time.	The casual style indicative of island life has been reproduced in this deck light. Coordinates with matching path light 15401 AZT on page 80.																																																																								
Ordering Guide & Finish	15047 OZ - Olde Bronze®	15461 AZT - Textured Architectural Bronze																																																																								
Housing	Cast Brass	Cast Aluminum																																																																								
Lamp Base	12V T5 wedge base socket	12V T5 wedge base socket 																																																																								
Supplied Lamp	6.5-W(VA) 918X (17022) Xenon light source Power usage at 12V AC input VA MAX: 6.5-W(VA)	6.5-W(VA) 918X (17022) Xenon light source Power usage at 12V AC input VA MAX: 6.5-W(VA)																																																																								
Incandescent Lamp Options	4-W(VA) 901X (17021)	4-W(VA) 901X (17021)																																																																								
LED Lamp Options	N/A	2W (18039-18041) see page 159 Compares up to 16W Xenon Light distribution may be affected by location of sockets																																																																								
Wiring	71" of usable #18-2, SPT-1-W leads. Cable connector supplied	72" of usable #18-2, SPT-1-W leads. Cable connector supplied																																																																								
Mounting Acces. Included	Stainless steel mounting bracket	Stainless steel mounting bracket																																																																								
Notes	U.S. Patent No. D573,293	N/A																																																																								
Photometric with Supplied Lamp	<table border="1"> <thead> <tr> <th>Mounting Height</th> <th>0'</th> <th>0.5'</th> <th>1'</th> <th>2'</th> <th>3'</th> <th>4'</th> <th>5'</th> </tr> </thead> <tbody> <tr> <td>6"</td> <td>3.6</td> <td>.25</td> <td>-</td> <td>-</td> <td>-</td> <td>-</td> <td>-</td> </tr> <tr> <td>12"</td> <td>2.1</td> <td>.76</td> <td>.15</td> <td>-</td> <td>-</td> <td>-</td> <td>-</td> </tr> <tr> <td>30"</td> <td>1.26</td> <td>.76</td> <td>.1</td> <td>-</td> <td>-</td> <td>-</td> <td>-</td> </tr> </tbody> </table>	Mounting Height	0'	0.5'	1'	2'	3'	4'	5'	6"	3.6	.25	-	-	-	-	-	12"	2.1	.76	.15	-	-	-	-	30"	1.26	.76	.1	-	-	-	-	<table border="1"> <thead> <tr> <th>Mounting Height</th> <th>.6'</th> <th>1'</th> <th>2'</th> <th>3'</th> <th>4'</th> <th>5'</th> <th>6'</th> <th>7'</th> <th>8'</th> </tr> </thead> <tbody> <tr> <td>6"</td> <td>53.30</td> <td>11.28</td> <td>1.08</td> <td>0.13</td> <td>0.03</td> <td>-</td> <td>-</td> <td>-</td> <td>-</td> </tr> <tr> <td>12"</td> <td>14.54</td> <td>7.90</td> <td>2.13</td> <td>0.79</td> <td>0.29</td> <td>0.08</td> <td>0.04</td> <td>-</td> <td>-</td> </tr> <tr> <td>30"</td> <td>2.90</td> <td>2.37</td> <td>1.45</td> <td>0.83</td> <td>0.50</td> <td>0.32</td> <td>0.20</td> <td>0.14</td> <td>0.10</td> </tr> </tbody> </table>	Mounting Height	.6'	1'	2'	3'	4'	5'	6'	7'	8'	6"	53.30	11.28	1.08	0.13	0.03	-	-	-	-	12"	14.54	7.90	2.13	0.79	0.29	0.08	0.04	-	-	30"	2.90	2.37	1.45	0.83	0.50	0.32	0.20	0.14	0.10
Mounting Height	0'	0.5'	1'	2'	3'	4'	5'																																																																			
6"	3.6	.25	-	-	-	-	-																																																																			
12"	2.1	.76	.15	-	-	-	-																																																																			
30"	1.26	.76	.1	-	-	-	-																																																																			
Mounting Height	.6'	1'	2'	3'	4'	5'	6'	7'	8'																																																																	
6"	53.30	11.28	1.08	0.13	0.03	-	-	-	-																																																																	
12"	14.54	7.90	2.13	0.79	0.29	0.08	0.04	-	-																																																																	
30"	2.90	2.37	1.45	0.83	0.50	0.32	0.20	0.14	0.10																																																																	

 Denotes fixture is compatible with incandescent or LED lamps.

INCANDESCENT/LED 12V HYBRID DECK & PATIO



15110 OZ - ZEN GARDEN™ DECK LIGHT

15071 OZ - ZEN GARDEN™ POST LIGHT

Description	Asian-inspired minimalist design for subtle deck lighting. Coordinates with matching Bollard 15392 OZ and with matching Path light 15391 OZ on page 84.	Serene, minimalist design and added security to supplement deck sconces. Coordinates with matching Bollard 15392 OZ and with matching Path light 15391 OZ on page 84.																																																				
Ordering Guide & Finish	15110 OZ - Olde Bronze®	15071 OZ - Olde Bronze®																																																				
Housing	Brass with textured seedy linen glass	Brass with textured linen seedy glass																																																				
Lamp Base	12V T5 wedge base socket	12V T5 wedge base socket 																																																				
Supplied Lamp	6.5-W(VA) 901X (17021) Xenon light source Power usage at 12V AC input VA MAX: 6.5-W(VA)	16.25-W(VA) 912X (17023) Xenon light source Power usage at 12V AC input VA MAX: 6.5-W(VA)																																																				
Incandescent Lamp Options	6.5-W(VA) 918X (17022)	16.25-W(VA) 921X (17025) 6.5-W(VA) 918X (17022) 4-W(VA) 901X (17021)																																																				
LED Lamp Options	N/A	2W (18039-18041) see page 159 Compares up to 16W Xenon Light distribution may be affected by location of sockets																																																				
Wiring	72" of usable #18-2, SPT-1-W leads. Cable connector supplied	59" of usable #18-2, SPT-1-W leads. Cable connector supplied																																																				
Mounting Acces. Included	Stainless steel mounting bracket	Post adaptor and Rail adaptor included are stainless steel Fits standard 4"x 4" post																																																				
Notes	N/A	U.S. Patent Pending																																																				
Photometric with Supplied Lamp	<table border="1"> <thead> <tr> <th>Mounting Height</th> <th>0'</th> <th>1'</th> <th>2'</th> <th>3'</th> <th>4'</th> <th>5'</th> <th>6'</th> </tr> </thead> <tbody> <tr> <td>6"</td> <td>26.53</td> <td>7.26</td> <td>1.33</td> <td>.06</td> <td>-</td> <td>-</td> <td>-</td> </tr> <tr> <td>12"</td> <td>7.63</td> <td>4</td> <td>1.46</td> <td>.2</td> <td>-</td> <td>-</td> <td>-</td> </tr> <tr> <td>30"</td> <td>1.06</td> <td>.93</td> <td>.7</td> <td>.3</td> <td>.03</td> <td>-</td> <td>-</td> </tr> </tbody> </table>	Mounting Height	0'	1'	2'	3'	4'	5'	6'	6"	26.53	7.26	1.33	.06	-	-	-	12"	7.63	4	1.46	.2	-	-	-	30"	1.06	.93	.7	.3	.03	-	-	<table border="1"> <thead> <tr> <th>Distance from Light</th> <th>1'</th> <th>2'</th> <th>3'</th> <th>4'</th> <th>5'</th> <th>6'</th> <th>7'</th> <th>8'</th> <th>9'</th> </tr> </thead> <tbody> <tr> <td>On 4" Mounting Height</td> <td>.23</td> <td>.03</td> <td>-</td> <td>-</td> <td>-</td> <td>-</td> <td>-</td> <td>-</td> <td>-</td> </tr> </tbody> </table>	Distance from Light	1'	2'	3'	4'	5'	6'	7'	8'	9'	On 4" Mounting Height	.23	.03	-	-	-	-	-	-	-
	Mounting Height	0'	1'	2'	3'	4'	5'	6'																																														
	6"	26.53	7.26	1.33	.06	-	-	-																																														
12"	7.63	4	1.46	.2	-	-	-																																															
30"	1.06	.93	.7	.3	.03	-	-																																															
Distance from Light	1'	2'	3'	4'	5'	6'	7'	8'	9'																																													
On 4" Mounting Height	.23	.03	-	-	-	-	-	-	-																																													



 Denotes fixture is compatible with incandescent or LED lamps.

INCANDESCENT/LED 12V HYBRID DECK & PATIO



15479 TZT - CATHEDRAL POST LIGHT

15474 OZ - LARKIN ESTATE™ POST LIGHT

Description	Cathedral arches and interwoven bands designed to crown deck posts and walls. Coordinates with matching Bollard 15449 TZT on page 77 and with matching Path light 15429 TZT on page 78.	Classic prairie styling in a rich dark bronze finish with warm amber glass. Coordinates with matching Path light 15444 OZ on page 82.
Ordering Guide & Finish	15479 TZT - Textured Tannery Bronze™	15474 OZ - Olde Bronze®
Housing	Aluminum with dark citrine glass	Brass with umber-etched glass
Lamp Base	12V T5 wedge base socket 	12V T5 wedge base socket 
Supplied Lamp	16.25-W(VA) 912X (17023) Xenon light source Power usage at 12V AC input VA MAX: 16.25-W(VA)	16.25-W(VA) 912X (17023) Xenon light source Power usage at 12V AC input VA MAX: 16.25-W(VA)
Incandescent Lamp Options	16.25-W(VA) 921X (17025) 6.5-W(VA) 918X (17022) 4-W(VA) 901X (17021)	16.25-W(VA) 921X (17025) 6.5-W(VA) 918X (17022) 4-W(VA) 901X (17021)
LED Lamp Options	2W (18039-18041) see page 159 Compares up to 16W Xenon Light distribution may be affected by location of sockets	2W (18039-18041) see page 159 Compares up to 16W Xenon Light distribution may be affected by location of sockets
Wiring	71" of usable #18-2, SPT-1-W leads. Cable connector supplied	71" of usable #18-2, SPT-1-W leads. Cable connector supplied
Mounting Acces. Included	Stainless steel rail mounting bracket for 4" x 4" post and adaptor for 6" x 6" post	Stainless steel rail mounting bracket for 4" x 4" post and adaptor for 6" x 6" post

 Denotes fixture is compatible with incandescent or LED lamps.

INCANDESCENT/LED 12V HYBRID DECK & PATIO

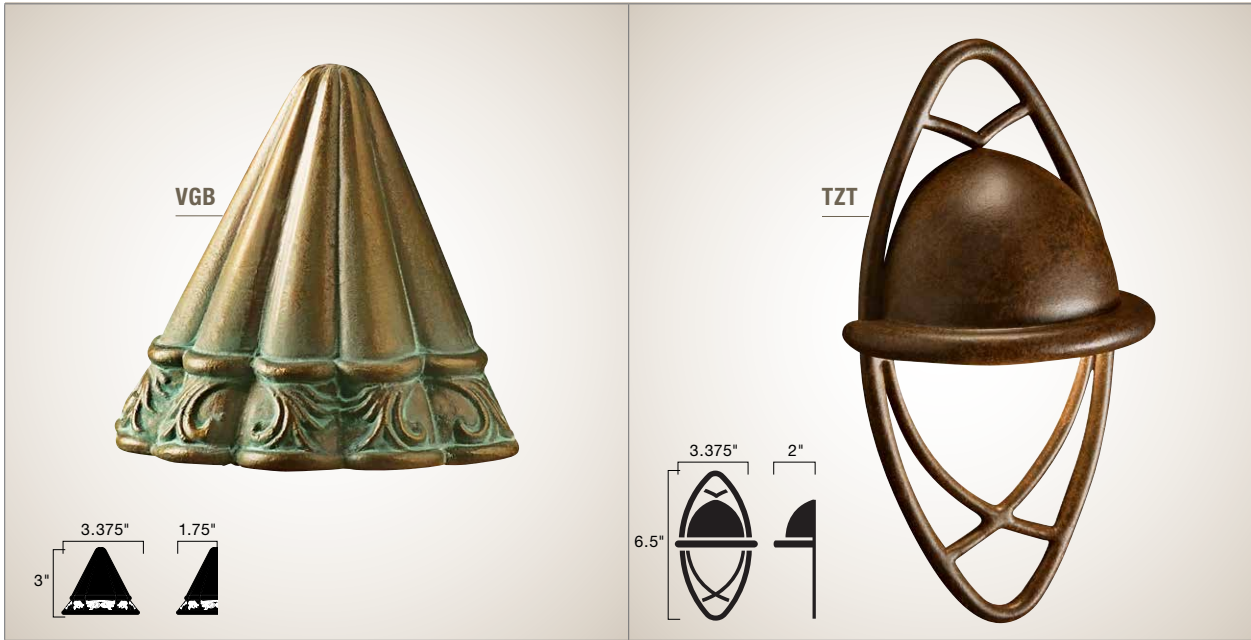

15021 VGB - AINSLEY SQUARE™ DECK LIGHT

15469 TZT - CATHEDRAL™ DECK LIGHT

Description	Charming detail in a decorative sconce with a Verdigris and Aged Brass finish.	Arches of interwoven bands dress the post as light flows down from the integral dome. Coordinates with matching Bollard 15449 TZT on page 77 and with matching Path light 15429 TZT on page 78.																																																																				
Ordering Guide & Finish	15021 VGB - Verdigris with Aged Brass	15469 TZT - Textured Tannery Bronze™																																																																				
Housing	Cast Brass	Aluminum																																																																				
Lamp Base	12V T5 wedge base socket	12V T5 wedge base socket																																																																				
Supplied Lamp	6.5-W(VA) 918X (17023) Xenon light source Power usage at 12V AC input VA MAX: 6.5-W(VA)	6.5-W(VA) 918X (17022) Xenon light source Power usage at 12V AC input VA MAX: 6.5-W(VA)																																																																				
Incandescent Lamp Options	4-W(VA) 901X (17021)	Optional: 4-W(VA) 901X (17021)																																																																				
LED Lamp Options	2W (18039-18041) see page 159 Compares up to 16W Xenon Light distribution may be affected by location of sockets	2W (18039-18041) see page 159 Compares up to 16W Xenon Light distribution may be affected by location of sockets																																																																				
Wiring	72" of usable #18-2, SPT-1-W leads. Cable connector supplied	72" of usable #18-2, SPT-1-W leads. Cable connector supplied																																																																				
Mounting Acces. Included	Stainless steel mounting bracket	Stainless steel mounting bracket																																																																				
Notes	U.S. Patent Pending	N/A																																																																				
Photometric with Supplied Lamp	<table border="1"> <thead> <tr> <th>Mounting Height</th> <th>0'</th> <th>1'</th> <th>2'</th> <th>3'</th> <th>4'</th> <th>5'</th> <th>6'</th> </tr> </thead> <tbody> <tr> <td>6"</td> <td>11.7</td> <td>4.65</td> <td>1.9</td> <td>-</td> <td>-</td> <td>-</td> <td>-</td> </tr> <tr> <td>12"</td> <td>2.86</td> <td>2.16</td> <td>1.36</td> <td>.2</td> <td>-</td> <td>-</td> <td>-</td> </tr> <tr> <td>30"</td> <td>.26</td> <td>.3</td> <td>.16</td> <td>.2</td> <td>.1</td> <td>-</td> <td>-</td> </tr> </tbody> </table>	Mounting Height	0'	1'	2'	3'	4'	5'	6'	6"	11.7	4.65	1.9	-	-	-	-	12"	2.86	2.16	1.36	.2	-	-	-	30"	.26	.3	.16	.2	.1	-	-	<table border="1"> <thead> <tr> <th>Mounting Height</th> <th>.6'</th> <th>1'</th> <th>2'</th> <th>3'</th> <th>4'</th> <th>5'</th> <th>6'</th> <th>7'</th> </tr> </thead> <tbody> <tr> <td>6"</td> <td>37.3</td> <td>8.88</td> <td>1.39</td> <td>.34</td> <td>.10</td> <td>.03</td> <td>-</td> <td>-</td> </tr> <tr> <td>12"</td> <td>13.6</td> <td>6.17</td> <td>1.85</td> <td>.74</td> <td>.35</td> <td>.18</td> <td>-</td> <td>-</td> </tr> <tr> <td>30"</td> <td>2.39</td> <td>2.01</td> <td>1.29</td> <td>.79</td> <td>.47</td> <td>.30</td> <td>-</td> <td>-</td> </tr> </tbody> </table>	Mounting Height	.6'	1'	2'	3'	4'	5'	6'	7'	6"	37.3	8.88	1.39	.34	.10	.03	-	-	12"	13.6	6.17	1.85	.74	.35	.18	-	-	30"	2.39	2.01	1.29	.79	.47	.30	-	-
Mounting Height	0'	1'	2'	3'	4'	5'	6'																																																															
6"	11.7	4.65	1.9	-	-	-	-																																																															
12"	2.86	2.16	1.36	.2	-	-	-																																																															
30"	.26	.3	.16	.2	.1	-	-																																																															
Mounting Height	.6'	1'	2'	3'	4'	5'	6'	7'																																																														
6"	37.3	8.88	1.39	.34	.10	.03	-	-																																																														
12"	13.6	6.17	1.85	.74	.35	.18	-	-																																																														
30"	2.39	2.01	1.29	.79	.47	.30	-	-																																																														

Denotes fixture is compatible with incandescent or LED lamps.

INCANDESCENT/LED 12V HYBRID DECK & PATIO



15064 AZT, BBR, BN, WHT - HALF MOON

15065 AZT, BBR, BKT, WHT - MINI DECK LIGHT

Description	Understated, modern style for deck or patio in a choice of contemporary finishes.	Versatile mini size and simple styling for multiple applications, available in a variety of finishes constructed of brass or aluminum.																																																																												
Ordering Guide & Finish	15064 AZT - Textured Architectural Bronze, Aluminum 15064 BBR - Bronzed Brass, Brass 15064 BN - Brushed Nickel 15064 WHT - Textured White, Aluminum	15065 AZT - Textured Architectural Bronze, Aluminum 15065 BBR - Bronzed Brass, Brass 15065 BKT - Textured Black, Aluminum 15065 WHT - Textured White, Aluminum																																																																												
Housing	Cast Aluminum or Cast Brass	Cast Aluminum or Cast Brass.																																																																												
Lamp Base	12V T3 bi-pin, high temperature porcelain socket	12V T5 wedge base socket																																																																												
Supplied Lamp	10-W(VA) Q10T3 (17011) Halogen light source Power usage at 12V AC input VA MAX: 10-W(VA)	6.5-W(VA) 918X (17022) Xenon light source Power usage at 12V AC input VA MAX: 6.5-W(VA)																																																																												
Incandescent Lamp Options	N/A	N/A																																																																												
LED Lamp Options	2W (18042-18044) see page 159 Compares up to 16W Xenon Light distribution may be affected by location of sockets	2W (18039-18041) see page 159 Compares up to 16W Xenon Light distribution may be affected by location of sockets																																																																												
Wiring	72" of usable #18-2, SPT-1-W leads. Cable connector supplied	72" of usable #18-2, SPT-1-W leads. Cable connector supplied																																																																												
Matching Outdoor Path Lights	15360	15005, 15011, 15315, 15326, 15327, 15328																																																																												
Mounting Acces. Included	N/A	Stainless Steel surface mounting bracket																																																																												
LED Option	See 15764 on page 25.	See 15765 on page 24.																																																																												
Photometric with Supplied Lamp	<table border="1"> <thead> <tr> <th>Mounting Height</th> <th>0'</th> <th>0.5'</th> <th>1'</th> <th>1.5'</th> <th>2'</th> <th>2.5'</th> <th>3'</th> <th>3.5'</th> <th>4'</th> <th>4.5'</th> </tr> </thead> <tbody> <tr> <td>6"</td> <td>53</td> <td>36.1</td> <td>4.7</td> <td>.9</td> <td>.2</td> <td>-</td> <td>-</td> <td>-</td> <td>-</td> <td>-</td> </tr> <tr> <td>12"</td> <td>13.8</td> <td>17.3</td> <td>6.9</td> <td>2.5</td> <td>.9</td> <td>.3</td> <td>.1</td> <td>-</td> <td>-</td> <td>-</td> </tr> <tr> <td>30"</td> <td>2.2</td> <td>3.2</td> <td>2.6</td> <td>2</td> <td>1.4</td> <td>.9</td> <td>.6</td> <td>.3</td> <td>.2</td> <td>.1</td> </tr> </tbody> </table>	Mounting Height	0'	0.5'	1'	1.5'	2'	2.5'	3'	3.5'	4'	4.5'	6"	53	36.1	4.7	.9	.2	-	-	-	-	-	12"	13.8	17.3	6.9	2.5	.9	.3	.1	-	-	-	30"	2.2	3.2	2.6	2	1.4	.9	.6	.3	.2	.1	<table border="1"> <thead> <tr> <th>Mounting Height</th> <th>1'</th> <th>2'</th> <th>3'</th> <th>4'</th> <th>5'</th> <th>6'</th> <th>7'</th> </tr> </thead> <tbody> <tr> <td>6"</td> <td>2.8</td> <td>.06</td> <td>.03</td> <td>-</td> <td>-</td> <td>-</td> <td>-</td> </tr> <tr> <td>12"</td> <td>4.1</td> <td>.73</td> <td>.15</td> <td>-</td> <td>-</td> <td>-</td> <td>-</td> </tr> <tr> <td>30"</td> <td>1.7</td> <td>.87</td> <td>.37</td> <td>.1</td> <td>-</td> <td>-</td> <td>-</td> </tr> </tbody> </table>	Mounting Height	1'	2'	3'	4'	5'	6'	7'	6"	2.8	.06	.03	-	-	-	-	12"	4.1	.73	.15	-	-	-	-	30"	1.7	.87	.37	.1	-	-	-
Mounting Height	0'	0.5'	1'	1.5'	2'	2.5'	3'	3.5'	4'	4.5'																																																																				
6"	53	36.1	4.7	.9	.2	-	-	-	-	-																																																																				
12"	13.8	17.3	6.9	2.5	.9	.3	.1	-	-	-																																																																				
30"	2.2	3.2	2.6	2	1.4	.9	.6	.3	.2	.1																																																																				
Mounting Height	1'	2'	3'	4'	5'	6'	7'																																																																							
6"	2.8	.06	.03	-	-	-	-																																																																							
12"	4.1	.73	.15	-	-	-	-																																																																							
30"	1.7	.87	.37	.1	-	-	-																																																																							

Denotes fixture is compatible with incandescent or LED lamps.

INCANDESCENT/LED 12V HYBRID DECK & PATIO



	15045 AZT - FULL BACK MINI DECK LIGHT	15468 AZT - RIBBED ROOF	15165 AZ - MINI DECK LIGHT																																																																																																
Description	Versatile mini size and simple styling. Integral full back for mounting on irregular surfaces.	Simple ribs and valleys are combined with a fluted column to blend with any deck setting.	Small size, simple styling and economical thermoplastic resin construction. Ideal for lighting along decks, porch steps and above stairways in salt air environments.																																																																																																
Ordering Guide & Finish	15045 AZT - Textured Architectural Bronze	15468 AZT - Textured Architectural Bronze	15165 AZ - Architectural Bronze™																																																																																																
Housing	Cast Aluminum	Cast Aluminum	Durable thermoplastic composite resin, one-piece construction. Extremely resistant to impact, weather and the effects of UV.																																																																																																
Lamp Base	12V T5 wedge base socket	12V T5 wedge base socket	12V T5 wedge base socket																																																																																																
Supplied Lamp	6.5-W(VA) 918X (17022) Xenon light source Power usage at 12V AC input VA MAX: 6.5-W(VA)	6.5-W(VA) 918X (17022) Xenon light source Power usage at 12V AC input VA MAX: 6.5-W(VA)	6.5-W(VA) 918X (17022) Xenon light source Power usage at 12V AC input VA MAX: 6.5-W(VA)																																																																																																
Incandescent Lamp Options	4-W(VA) 901X (17021)	4-W(VA) 901X (17021)	4-W(VA) 901X (17021)																																																																																																
LED Lamp Options	2W (18039-18041) see page 159 Compares up to 16W Xenon Light distribution may be affected by location of sockets	2W (18039-18041) see page 159 Compares up to 16W Xenon Light distribution may be affected by location of sockets	2W (18039-18041) see page 159 Compares up to 16W Xenon Light distribution may be affected by location of sockets																																																																																																
Wiring	72" of usable #18-2, SPT-1-W leads Cable connector supplied	72" of usable #18-2, SPT-1-W leads Cable connector supplied	71" of usable #18-2, SPT-1-W leads Cable connector supplied																																																																																																
Matching Outdoor Path Lights	15005, 15011, 15315, 15326, 15327, 15328	15418	NA																																																																																																
Mounting Acces. Included	N/A	Stainless Steel surface mounting bracket	Stainless Steel surface mounting bracket																																																																																																
Photometric with Supplied Lamp	<table border="1"> <thead> <tr> <th>Mounting Height</th> <th>1'</th> <th>2'</th> <th>3'</th> <th>4'</th> <th>5'</th> <th>6'</th> <th>7'</th> </tr> </thead> <tbody> <tr> <td>6"</td> <td>2.8</td> <td>.06</td> <td>.03</td> <td>-</td> <td>-</td> <td>-</td> <td>-</td> </tr> <tr> <td>12"</td> <td>4.1</td> <td>.73</td> <td>.15</td> <td>-</td> <td>-</td> <td>-</td> <td>-</td> </tr> <tr> <td>30"</td> <td>1.7</td> <td>.87</td> <td>.37</td> <td>.1</td> <td>-</td> <td>-</td> <td>-</td> </tr> </tbody> </table>	Mounting Height	1'	2'	3'	4'	5'	6'	7'	6"	2.8	.06	.03	-	-	-	-	12"	4.1	.73	.15	-	-	-	-	30"	1.7	.87	.37	.1	-	-	-	<table border="1"> <thead> <tr> <th>Mounting Height</th> <th>1'</th> <th>2'</th> <th>3'</th> <th>4'</th> <th>5'</th> <th>6'</th> <th>7'</th> </tr> </thead> <tbody> <tr> <td>6"</td> <td>10.52</td> <td>1.21</td> <td>.35</td> <td>.14</td> <td>.08</td> <td>-</td> <td>-</td> </tr> <tr> <td>12"</td> <td>7.56</td> <td>1.92</td> <td>.66</td> <td>.28</td> <td>.15</td> <td>-</td> <td>-</td> </tr> <tr> <td>30"</td> <td>2.61</td> <td>1.54</td> <td>.84</td> <td>.48</td> <td>.31</td> <td>-</td> <td>-</td> </tr> </tbody> </table>	Mounting Height	1'	2'	3'	4'	5'	6'	7'	6"	10.52	1.21	.35	.14	.08	-	-	12"	7.56	1.92	.66	.28	.15	-	-	30"	2.61	1.54	.84	.48	.31	-	-	<table border="1"> <thead> <tr> <th>Mounting Height</th> <th>1'</th> <th>2'</th> <th>3'</th> <th>4'</th> <th>5'</th> <th>6'</th> <th>7'</th> </tr> </thead> <tbody> <tr> <td>6"</td> <td>1.9</td> <td>.03</td> <td>-</td> <td>-</td> <td>-</td> <td>-</td> <td>-</td> </tr> <tr> <td>12"</td> <td>2.4</td> <td>.4</td> <td>-</td> <td>-</td> <td>-</td> <td>-</td> <td>-</td> </tr> <tr> <td>30"</td> <td>.9</td> <td>.4</td> <td>.2</td> <td>-</td> <td>-</td> <td>-</td> <td>-</td> </tr> </tbody> </table>	Mounting Height	1'	2'	3'	4'	5'	6'	7'	6"	1.9	.03	-	-	-	-	-	12"	2.4	.4	-	-	-	-	-	30"	.9	.4	.2	-	-	-	-
Mounting Height	1'	2'	3'	4'	5'	6'	7'																																																																																												
6"	2.8	.06	.03	-	-	-	-																																																																																												
12"	4.1	.73	.15	-	-	-	-																																																																																												
30"	1.7	.87	.37	.1	-	-	-																																																																																												
Mounting Height	1'	2'	3'	4'	5'	6'	7'																																																																																												
6"	10.52	1.21	.35	.14	.08	-	-																																																																																												
12"	7.56	1.92	.66	.28	.15	-	-																																																																																												
30"	2.61	1.54	.84	.48	.31	-	-																																																																																												
Mounting Height	1'	2'	3'	4'	5'	6'	7'																																																																																												
6"	1.9	.03	-	-	-	-	-																																																																																												
12"	2.4	.4	-	-	-	-	-																																																																																												
30"	.9	.4	.2	-	-	-	-																																																																																												

Denotes fixture is compatible with incandescent or LED lamps.

INCANDESCENT/LED 12V HYBRID DECK & PATIO



15077 AZT - ADJUSTABLE UNDER RAILING LIGHT

15066 AZT, WHT - LOUVERED DOWN LIGHT

Description	Adaptable, compact fixture for safety and security. Installs under deck railing or wall mount.	Compact and contemporary, designed for lighting on rails, along decks, patios or stairways.																																																								
Ordering Guide & Finish	15077 AZT - Textured Architectural Bronze	15066 AZT - Textured Architectural Bronze 15066 WHT - Textured White																																																								
Housing	Aluminum	Aluminum																																																								
Lamp Base	12V S8 wedge base socket 	12V T5 wedge base socket																																																								
Supplied Lamp	18.5-W(VA) 3155K (15599 CLR) Krypton light source Power usage at 12V AC input VA MAX: 18.5-W(VA)	6.5-W(VA) 918X (17022) Xenon light source Power usage at 12V AC input VA MAX: 6.5-W(VA)																																																								
Incandescent Lamp Options	N/A	4-W(VA) 901X (17021)																																																								
LED Lamp Options	2W (18036-18038) see page 159 Compares up to 18.5W Krypton.	N/A																																																								
Wiring	72" of usable #18-2, SPT-1-W leads. Cable connector supplied	72" of usable #18-2, SPT-1-W leads. Cable connector supplied																																																								
Mounting Acces. Included	Mounting hardware	Stainless steel mounting plate																																																								
Notes	N/A	U.S. Patent No. D437,445																																																								
Photometric with Supplied Lamp	<table border="1"> <thead> <tr> <th>Distance from Light</th> <th>1'</th> <th>2'</th> <th>3'</th> <th>4'</th> <th>5'</th> <th>6'</th> <th>7'</th> <th>8'</th> <th>9'</th> </tr> </thead> <tbody> <tr> <td>Footcandles</td> <td>4.7</td> <td>3.1</td> <td>1.5</td> <td>.35</td> <td>.15</td> <td>.08</td> <td>-</td> <td>-</td> <td>-</td> </tr> </tbody> </table>	Distance from Light	1'	2'	3'	4'	5'	6'	7'	8'	9'	Footcandles	4.7	3.1	1.5	.35	.15	.08	-	-	-	<table border="1"> <thead> <tr> <th>Mounting Height</th> <th>.5'</th> <th>1'</th> <th>1.5'</th> <th>2'</th> <th>2.5'</th> <th>3'</th> <th>3.5'</th> <th>4'</th> </tr> </thead> <tbody> <tr> <td>6"</td> <td>5.2</td> <td>.4</td> <td>-</td> <td>-</td> <td>-</td> <td>-</td> <td>-</td> <td>-</td> </tr> <tr> <td>12"</td> <td>19.</td> <td>.6</td> <td>.1</td> <td>-</td> <td>-</td> <td>-</td> <td>-</td> <td>-</td> </tr> <tr> <td>30"</td> <td>2.4</td> <td>.2</td> <td>.1</td> <td>-</td> <td>-</td> <td>-</td> <td>-</td> <td>-</td> </tr> </tbody> </table>	Mounting Height	.5'	1'	1.5'	2'	2.5'	3'	3.5'	4'	6"	5.2	.4	-	-	-	-	-	-	12"	19.	.6	.1	-	-	-	-	-	30"	2.4	.2	.1	-	-	-	-	-
Distance from Light	1'	2'	3'	4'	5'	6'	7'	8'	9'																																																	
Footcandles	4.7	3.1	1.5	.35	.15	.08	-	-	-																																																	
Mounting Height	.5'	1'	1.5'	2'	2.5'	3'	3.5'	4'																																																		
6"	5.2	.4	-	-	-	-	-	-																																																		
12"	19.	.6	.1	-	-	-	-	-																																																		
30"	2.4	.2	.1	-	-	-	-	-																																																		

 Denotes fixture is compatible with incandescent or LED lamps.

INCANDESCENT/LED 12V HYBRID DECK & PATIO



15079 AZT - UP/DOWN ACCENT LIGHT

15123 BK - BARBECUE LIGHT

Description	Attractive and functional up and down light blends with a range of architectural styles.	Integrated surface mount BBQ light for direct connection to 12V landscape lighting system for rail or outdoor countertop mount only.																				
Ordering Guide & Finish	15079 AZT - Textured Architectural Bronze	15123 BK - Black																				
Housing	Aluminum	Components of durable high heat thermoplastic resin. Lamp shielded by a high heat-resistant flat glass lens sealed for watertight outdoor use. Flexible stem is durable chrome plated steel with heat shrink rubber sleeving. On/off switch is protected by waterproof rubber boot																				
Lamp Base	12V T5 wedge base socket 	12V bi-pin, high temperature porcelain socket																				
Supplied Lamp	11.6-W(VA) 912X (17023) (2) Xenon light source Power usage at 12V AC input VA MAX: 11.6-W(VA)	35-W(VA) MR11 Halogen light source Power usage at 12V AC input VA MAX: 35-W(VA)																				
Incandescent Lamp Options	6.5-W(VA) 918X (17022) 4-W (VA) 901X (17021)	N/A																				
LED Lamp Options	2W (18039-18041) see page 159 Compares up to 16W Xenon	N/A																				
Wiring	70" of usable #18-2, SPT-1-W leads Cable connector supplied with fixture	25' of usable #18-2, SPT-1-W leads Connector supplied																				
Mounting Acces. Included	Stainless Steel surface mounting plate	(1) set wood screws and (1) set machine screws and nuts																				
Optional Len Acces.	15659 – Lens	NA																				
Photometric with Supplied Lamp	<table border="1"> <tr> <td>Distance from Light</td> <td>1'</td> <td>2'</td> <td>3'</td> <td>4'</td> <td>5'</td> <td>6'</td> <td>7'</td> <td>8'</td> <td>9'</td> </tr> <tr> <td>Footcandles</td> <td>2.2</td> <td>1.2</td> <td>.8</td> <td>.6</td> <td>.1</td> <td>-</td> <td>-</td> <td>-</td> <td>-</td> </tr> </table>		Distance from Light	1'	2'	3'	4'	5'	6'	7'	8'	9'	Footcandles	2.2	1.2	.8	.6	.1	-	-	-	-
Distance from Light	1'	2'	3'	4'	5'	6'	7'	8'	9'													
Footcandles	2.2	1.2	.8	.6	.1	-	-	-	-													

 Denotes fixture is compatible with incandescent or LED lamps.

INCANDESCENT/LED 12V HYBRID DECK & PATIO



INCANDESCENT/LED 12V HYBRID DECK & PATIO

	15070 AZT / 15072 AZT, CO, WHT - MINI STEP LIGHT	15074 AZT - BRICK LIGHT - GLASS LENS / 15073 AZT - LOUVERED																																																																				
Description	Designed to be integrated into outdoor steps. Casts a low, even spread of light. Available with louvered or white acrylic faceplate.	Designed to be integrated into brick walls during construction. Casts a low, even spread of light.																																																																				
Ordering Guide & Finish	15070 AZT - Acrylic Lens, Textured Architectural Bronze, Aluminum 15072 AZT - Louvered Lens, Textured Architectural Bronze, Aluminum 15072 CO - Louvered Lens, Copper, Unfinished Copper 15072 WHT - Louvered Lens, Textured White, Aluminum	15074 AZT - Textured Architectural Bronze 15073 AZT - Textured Architectural Bronze																																																																				
Housing	Aluminum or copper faceplate with white reflector. Zinc plated steel housing. White acrylic diffuser on 15070 only	Cast Aluminum with a fully sealed heat-resistant glass lens																																																																				
Lamp Base	12V T5 wedge base socket	(2) 12V T3 bi-pin, high temperature porcelain sockets																																																																				
Supplied Lamp	11.6-W(VA) 912X (17023) 6.5-W(VA) 918X MAX supplied on copper Xenon light source Power usage at 12V AC input VA MAX: 11.6-W(VA)	10-W(VA) Q10T3 (17011) Halogen (2) Halogen light source Power usage at 12V AC input VA MAX: 10-W(VA)																																																																				
Incandescent Lamp Options	6.5-W(VA) 918X (17022) 4-W(VA) 901X (17021)	N/A																																																																				
LED Lamp Options	2W (18039-18041) see page 159 Compares up to 16W Xenon. Light distribution may be affected by location of sockets.	2W (18042-18044) see page 159 Compares up to 20W Halogen. Light distribution may be affected by location of sockets.																																																																				
Wiring	Wire connection must be made inside fixture housing. 90° supply wire required	Wire connection must be made inside fixture housing. 75° supply wire required																																																																				
Mounting Acces. Included	Mounting hardware and junction box	Stainless steel mounting bracket																																																																				
LED Option	15782 and 15780 - on page 26.	15774 and 15773 - on page 25.																																																																				
Notes	For recessed installation. For outdoor use only	For outdoor use only. Masonry or concrete use only																																																																				
Photometric with Supplied Lamp	<table border="1"> <thead> <tr> <th>15070 Mounting Height</th> <th>0.5'</th> <th>1'</th> <th>1.5'</th> <th>2'</th> <th>2.5'</th> <th>3'</th> <th>3.5'</th> </tr> </thead> <tbody> <tr> <td>6"</td> <td>2.1</td> <td>.5</td> <td>.1</td> <td>-</td> <td>-</td> <td>-</td> <td>-</td> </tr> <tr> <td>12"</td> <td>1.2</td> <td>.98</td> <td>.5</td> <td>.2</td> <td>.1</td> <td>.02</td> <td>-</td> </tr> </tbody> </table>	15070 Mounting Height	0.5'	1'	1.5'	2'	2.5'	3'	3.5'	6"	2.1	.5	.1	-	-	-	-	12"	1.2	.98	.5	.2	.1	.02	-	<table border="1"> <thead> <tr> <th>15074 Mounting Height</th> <th>0.5'</th> <th>1'</th> <th>1.5'</th> <th>2'</th> <th>2.5'</th> <th>3'</th> <th>3.5'</th> <th>4'</th> </tr> </thead> <tbody> <tr> <td>12"</td> <td>-</td> <td>-</td> <td>-</td> <td>-</td> <td>.01</td> <td>.04</td> <td>.04</td> <td>-</td> </tr> <tr> <td>24"</td> <td>-</td> <td>-</td> <td>.06</td> <td>.1</td> <td>.09</td> <td>.04</td> <td>.04</td> <td>-</td> </tr> <tr> <td>36"</td> <td>.02</td> <td>.04</td> <td>.04</td> <td>.04</td> <td>.04</td> <td>.04</td> <td>.01</td> <td>-</td> </tr> </tbody> </table>	15074 Mounting Height	0.5'	1'	1.5'	2'	2.5'	3'	3.5'	4'	12"	-	-	-	-	.01	.04	.04	-	24"	-	-	.06	.1	.09	.04	.04	-	36"	.02	.04	.04	.04	.04	.04	.01	-								
15070 Mounting Height	0.5'	1'	1.5'	2'	2.5'	3'	3.5'																																																															
6"	2.1	.5	.1	-	-	-	-																																																															
12"	1.2	.98	.5	.2	.1	.02	-																																																															
15074 Mounting Height	0.5'	1'	1.5'	2'	2.5'	3'	3.5'	4'																																																														
12"	-	-	-	-	.01	.04	.04	-																																																														
24"	-	-	.06	.1	.09	.04	.04	-																																																														
36"	.02	.04	.04	.04	.04	.04	.01	-																																																														
	<table border="1"> <thead> <tr> <th>15072 Mounting Height</th> <th>0.5'</th> <th>1'</th> <th>1.5'</th> <th>2'</th> <th>2.5'</th> <th>3'</th> <th>3.5'</th> </tr> </thead> <tbody> <tr> <td>6"</td> <td>2.6</td> <td>.3</td> <td>.09</td> <td>-</td> <td>-</td> <td>-</td> <td>-</td> </tr> <tr> <td>12"</td> <td>1.6</td> <td>1.2</td> <td>.54</td> <td>.08</td> <td>.1</td> <td>.04</td> <td>-</td> </tr> </tbody> </table>	15072 Mounting Height	0.5'	1'	1.5'	2'	2.5'	3'	3.5'	6"	2.6	.3	.09	-	-	-	-	12"	1.6	1.2	.54	.08	.1	.04	-	<table border="1"> <thead> <tr> <th>15073 Mounting Height</th> <th>0.5'</th> <th>1'</th> <th>1.5'</th> <th>2'</th> <th>2.5'</th> <th>3'</th> <th>3.5'</th> <th>4'</th> <th>4.5'</th> <th>5'</th> </tr> </thead> <tbody> <tr> <td>12"</td> <td>.3</td> <td>1.1</td> <td>.8</td> <td>.5</td> <td>.1</td> <td>.02</td> <td>-</td> <td>-</td> <td>-</td> <td>-</td> </tr> <tr> <td>24"</td> <td>-</td> <td>-</td> <td>.1</td> <td>.2</td> <td>.2</td> <td>.2</td> <td>.1</td> <td>.03</td> <td>.02</td> <td>-</td> </tr> <tr> <td>36"</td> <td>-</td> <td>-</td> <td>-</td> <td>-</td> <td>.01</td> <td>.01</td> <td>.03</td> <td>.06</td> <td>.03</td> <td>.01</td> </tr> </tbody> </table>	15073 Mounting Height	0.5'	1'	1.5'	2'	2.5'	3'	3.5'	4'	4.5'	5'	12"	.3	1.1	.8	.5	.1	.02	-	-	-	-	24"	-	-	.1	.2	.2	.2	.1	.03	.02	-	36"	-	-	-	-	.01	.01	.03	.06	.03	.01
15072 Mounting Height	0.5'	1'	1.5'	2'	2.5'	3'	3.5'																																																															
6"	2.6	.3	.09	-	-	-	-																																																															
12"	1.6	1.2	.54	.08	.1	.04	-																																																															
15073 Mounting Height	0.5'	1'	1.5'	2'	2.5'	3'	3.5'	4'	4.5'	5'																																																												
12"	.3	1.1	.8	.5	.1	.02	-	-	-	-																																																												
24"	-	-	.1	.2	.2	.2	.1	.03	.02	-																																																												
36"	-	-	-	-	.01	.01	.03	.06	.03	.01																																																												

Denotes fixture is compatible with incandescent or LED lamps.





KICHLER®

Incandescent/LED 12V Hybrid Accent

Create dramatic effects that make a landscape come alive at night.



INCANDESCENT/LED 12V HYBRID ACCENT



15384 AZT, AZT 20L, AZT 24, BBR, BKT, BKT 24, CO - MINI ACCENT

Description	For uplighting only (spotlighting, cross-lighting, grazing).	
Ordering Guide & Finish	15384 AZT - Textured Architectural Bronze, Aluminum 15384 AZT 20L - Same as 15384 AZT. 20-W MR-16, FL 36° included. 15384 AZT 24 - Same as 15384 AZT. Bulk packed in 24 (unbreakable master) 15384 BBR - Bronzed Brass, Brass 15384 BBR 20L- Same as 15384 BBR. 20-W MR-16, FL 36° included. 15384 BKT - Textured Black, Aluminum 15384 BKT 24 - Same as 15384 BKT. Bulk packed in 24 (unbreakable master) 15384 CO - Unfinished Copper. Extruded copper cowl. Die-cast brass knuckle/stem.	
Housing	Cast Aluminum, Cast Brass or Unfinished Copper. Heat resistant flat glass lens is fully sealed.	
Lamp Base	12V Incandescent bi-pin, high temperature porcelain socket 	
Supplied Lamp	Lamp not supplied unless noted. Halogen light source.	
Incandescent Lamp Options	Power usage at 12V AC input VA MAX: 50-W(VA) MR-16 35-W(VA) Max. on 15384CO 20-W(VA) Max. Canada see page 161	
LED Lamp Options	4W (18000-18011) see page 159 Compares to 20W Halogen 6W (18012-18020) see page 159 Compares to 35W Halogen	
Wiring	35" of usable #18-2, SPT-1-W leads. Cable connector supplied	
Mounting Acces. Included	8" In-ground stake	
Optional Mounting Accessories	15601 - Surface Mounting Flange 15607 - Surface Mounting Flange 15609 - Junction Box Mounting Bracket	15647 - 90° Elbow 15649 - Stem Coupler 15645, 15656, 15657, 15658 or 15570 - Stems
Optional Lens Accessories	15675 LIN - Linear Lens 15676 FRO - Frosted Lens 15679 BK - Hexcell Louver Shield 15686 BL - Blue Filter	
Notes	See page 200 for photometrics. Copper will naturally patina over time.	



 Denotes fixture is compatible with incandescent or LED lamps.

INCANDESCENT / LED 12V HYBRID ACCENT



15484 AZT - LONG COWL MINI-ACCENT LIGHT (UP AND DOWN)

15397 AZT - ARCHITECTURAL GRADE ADJUSTABLE ACCENT LIGHT

Description	A compact (2¼" diameter) accent light with extra long cowl for up and down lighting versatility.		Recommend for up or down spotlighting, cross-lighting and grazing. Use with the 6" (15645), 12" (15656), 18" (15657) or 24" (15658) mounting stem for dramatic effects.	
Ordering Guide & Finish	15484 AZT - Textured Architectural Bronze		15397 AZT - Textured Architectural Bronze	
Housing	Cast Aluminum. Heat-resistant flat glass lens is fully sealed.		Machined aluminum. Heat-resistant glass is fully sealed and angled for easy water run-off. Cowl is fully adjustable.	
Lamp Base	12V Incandescent bi-pin, high temperature porcelain socket 		12V Incandescent bi-pin, high temperature porcelain socket 	
Supplied Lamp	Lamp not supplied unless noted		Lamp not supplied unless noted	
Incandescent Lamp Options	Power usage at 12V AC input VA MAX: 50-W(VA) MR-16 20-W(VA) Max. Canada 35-W(VA) MR-11 see page 161		Power usage at 12V AC input VA MAX: 50-W(VA) MR-16 35-W(VA) Max. Canada 35-W(VA) MR-11 see page 161	
LED Lamp Options	4W (18000-18011) see page 159 Compares to 20W Halogen 6W (18012-18020) see page 159 Compares to 35W Halogen		4W (18000-18011) see page 159 Compares to 20W Halogen 6W (18012-18020) see page 159 Compares to 35W Halogen	
Wiring	35" of usable #18-2, SPT-1-W leads. Connector supplied		51" of usable #18-2, SPT-1-W leads. Cable connector supplied	
Mounting Acces. Included	8" In-ground stake		8" In-ground stake	
Optional Mounting Accessories	15601 - Surface Mounting Flange 15607 - Surface Mounting Flange 15609 - Junction Box Mounting Bracket	15647 - 90° Elbow 15649 - Stem Coupler 15645, 15656, 15657, 15658 or 15570 - Stems	15601 - Surface Mounting Flange 15607 - Surface Mounting Flange 15609 - Junction Box Mounting Bracket	15647 - 90° Elbow 15649 - Stem Coupler 15645, 15656, 15657, 15658 or 15570 - Stems
Optional Lens Accessories	15679 BK - Louver 15686 BL - Blue Filter	15676 FRO - Frosted Lens 15675 LIN - Linear Lens	15683 BK - Louver 15693 BL - Blue Filter	
Notes	See page 200 for photometrics		See page 200 for photometrics	

 Denotes fixture is compatible with incandescent or LED lamps.

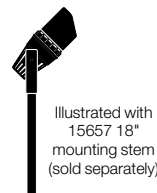
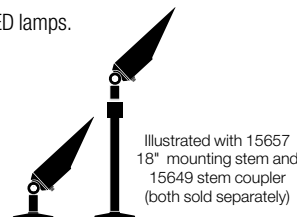

INCANDESCENT / LED 12V HYBRID ACCENT



15398 AZT - MICRO ACCENT - MR 11 ACCENT LIGHT

15309 AZT, BKT - ACCENT LIGHT

Description	Our smallest incandescent (1 7/8") accent light. Recommended for up or down narrow spotlighting, cross-lighting and grazing for specialty applications.	Accent light for up or down spotlighting, cross-lighting and grazing.
Ordering Guide & Finish	15398 AZT – Textured Architectural Bronze	15309 AZT – Textured Architectural Bronze 15309 AZT 12 – Same as 15309 AZT. Bulk packed in 12 (unbreakable master). 15309 BKT – Textured Black
Housing	Cast Aluminum. Heat-resistant glass is fully sealed.	Cast Aluminum. Heat resistant flat glass lens is fully sealed.
Lamp Base	12V Incandescent bi-pin, high temperature porcelain socket	12V Incandescent bi-pin, high temperature porcelain socket
Supplied Lamp	Lamp not supplied unless noted	20-W(VA) MR-16 Halogen light source
Incandescent Lamp Options	Power usage at 12V AC input VA MAX: 35-W(VA) MR-11 20-W(VA) Max. Canada see page 161	Power usage at 12V AC input VA MAX: 35-W(VA) MR-16 35-W(VA) MR-11 see page 161
LED Lamp Options	N/A	4W (18000-18011) see page 159 Compares to 20W Halogen
Wiring	36" of usable #18-2, SPT-1-W leads. Cable connector supplied	40" of usable #18-2, SPT-1-W leads. Cable connector supplied. 12V
Mounting Acces. Included	8" In-ground stake	8" In-ground stake
Optional Mounting Accessories	15601 – Surface Mounting Flange 15607 – Surface Mounting Flange 15609 – Junction Box Mounting Bracket	15647 – 90° Elbow 15649 – Stem Coupler 15645, 15656, 15657, 15658 or 15570 – Stems
Optional Lens Accessories	15631 BL – Blue Filter 15632 LIN – Linear Lens 15633 FRO – Frosted Lens 15634 BK – Louver	15601 – Surface Mounting Flange 15607 – Surface Mounting Flange 15609 – Junction Box Mounting Bracket
Notes	See page 200 for photometrics	See page 200 for photometrics

Denotes fixture is compatible with incandescent or LED lamps.

INCANDESCENT / LED 12V HYBRID ACCENT



15374 AZT, AZT 20L, AZT 20L 24, BE 20L, BKT, BKT 20L 24 - MINI ACCENT LIGHT

Description	A compact (2¼" diameter) accent light for a variety of up and down lighting special effects such as spotlighting, cross-lighting and grazing.	
Ordering Guide & Finish	15374 AZT - Textured Architectural Bronze 15374 AZT 20L - Same as 15374 AZT. 20-W MR-16, FL 36° included 15374 AZT 20L 24 - Same as 15374 AZT. 20-W MR-16, FL 36° included. Bulk packed in 24 (unbreakable master). 15374 BE 20L - Beach, 20-W MR16, FL 36° 15374 BKT - Textured Black 15374 BKT 20L 24 - Same as 15374 BKT. 20-W MR-16, FL 36° included. Bulk packed in 24 (unbreakable master).	
Housing	Cast Aluminum. Heat resistant flat glass lens is fully sealed	
Lamp Base	12V Incandescent bi-pin, high temperature porcelain socket 	
Supplied Lamp	Lamp not supplied unless noted	
Incandescent Lamp Options	Power usage at 12V AC input VA MAX: 50-W(VA) MR-16 20-W(VA) Max. Canada see page 161	
LED Lamp Options	4W (18000-18011) see page 159 Compares to 20W Halogen	6W (18012-18020) see page 159 Compares to 35W Halogen
Wiring	31" of usable #18-2, SPT-1-W leads. Cable connector supplied	
Mounting Acces. Included	8" In-ground stake	
Optional Mounting Accessories	15601 - Surface Mounting Flange 15607 - Surface Mounting Flange 15609 - Junction Box Mounting Bracket	15647 - 90° Elbow 15649 - Stem Coupler 15645, 15656, 15657, 15658 or 15570 - Stems
Optional Lens Accessories	15641 BL - Blue Filter 15642 LIN - Linear Lens 15643 FRO - Frosted Lens 15644 BK - Hexcell Louver Shield	
Notes	See page 200 for photometrics	

 Denotes fixture is compatible with incandescent or LED lamps.

15374 illustrated with 15649 stem coupler, 15601 surface flange and 15656 mounting stem (sold separately)



INCANDESCENT / LED 12V HYBRID ACCENT



15382 BK - COMPOSITE ACCENT LIGHT

Description	For up or down spotlighting, cross-lighting and grazing. A cost-effective, corrosion-resistant option in harsh environments.	
Ordering Guide & Finish	15382 BK - Black	
Housing	Components of durable high heat thermoplastic composite resin. Heat-resistant flat glass lens is fully sealed.	
Lamp Base	12V Incandescent bi-pin, high temperature porcelain socket 	
Supplied Lamp	Lamp not supplied unless noted	
Incandescent Lamp Options	Power usage at 12V AC input VA MAX: 35-W(VA) MR-16 see page 161	
LED Lamp Options	4W (18000-18011) see page 159 Compares to 20W Halogen 6W (18012-18020) see page 159 Compares to 35W Halogen	
Wiring	30" usable #18-2, SPT-1-W leads. Cable connector supplied	
Mounting Acces. Included	8" In-ground stake	
Optional Mounting Accessories	15601 - Surface Mounting Flange 15607 - Surface Mounting Flange 15609 - Junction Box Mounting Bracket	15647 - 90° Elbow 15649 - Stem Coupler 15645, 15656, 15657, 15658 or 15570 - Stems
Optional Lens Accessories	15673 BL - Blue Filter 15672 FRO - Frosted Lens 15674 LIN - Linear Lens	
Notes	U.S. Patent D417,519 See page 200 for photometrics	

 Denotes fixture is compatible with incandescent or LED lamps.

INCANDESCENT / LED 12V HYBRID ACCENT



15381 AZT, AZT 6, BBR, BKT - MR-16 ACCENT LIGHT

Description	Larger (4½" diameter) for up or down wider light spread along walls, shrubs, and trees.	
Ordering Guide & Finish	15381 AZT – Textured Architectural Bronze, Aluminum 15381 AZT 6 – Same as 15381AZT. Bulk packed in 6 (unbreakable master) 15381 BBR – Bronzed Brass, Brass 15381 BKT – Textured Black, Aluminum	
Housing	Cast Aluminum or Cast Brass. Heat resistant flat glass lens is fully sealed.	
Lamp Base	12V Incandescent bi-pin, high temperature porcelain socket 	
Supplied Lamp	Lamp not supplied unless noted	
Incandescent Lamp Options	Power usage at 12V AC input VA MAX: 75-W(VA) MR-16 see page 161	
LED Lamp Options	4W (18000-18011) see page 159 Compares to 20W Halogen 6W (18012-18020) see page 159 Compares to 35W Halogen	
Wiring	35" of usable #18-2, SPT-1-W leads. Cable connector supplied	
Mounting Acces. Included	8" In-ground stake	
Optional Mounting Accessories	15601 – Surface Mounting Flange 15607 – Surface Mounting Flange 15609 – Junction Box Mounting Bracket	15647 – 90° Elbow 15649 – Stem Coupler 15645, 15656, 15657, 15658 or 15570 – Stems
Optional Lens Accessories	15680 BK – Hexcell Louver Shield 15687 BL – Blue Filter 15691 FRO – Frosted Lens 15692 LIN – Linear Lens	
Notes	See page 200 for photometrics	

 Denotes fixture is compatible with incandescent or LED lamps.

INCANDESCENT / LED 12V HYBRID ACCENT



15383 AZT - BI-PIN ACCENT LIGHT

15390 AZT - PAR 36 ACCENT LIGHT

Description	The clarity of halogen in a larger (4½" diameter) size for wider up or down light spread.				A full-size (5¼" diameter) adjustable accent light, recommend for up or down wall washing and other wider beam spread applications.																																																								
Ordering Guide & Finish	15383 AZT – Textured Architectural Bronze				15390 AZT – Textured Architectural Bronze																																																								
Housing	Cast Aluminum. Heat-resistant flat glass is fully sealed.				Cast Aluminum																																																								
Lamp Base	12V Incandescent bi-pin, high temperature porcelain socket				12V Incandescent PAR-36 lamp 																																																								
Supplied Lamp	50-W(VA) Q50T4 (17015) Halogen light source				Lamp not supplied unless noted																																																								
Incandescent Lamp Options	Power usage at 12V AC input VA MAX: VA MAX: 75-W(VA) see page 161				Power usage at 12V AC input VA MAX: 50-W(VA) PAR-36 see page 161																																																								
LED Lamp Options	N/A				11W (18021-18029) see page 159 Compares to 50W Halogen																																																								
Wiring	38" of usable #18-2, SPT-1-W leads. Cable connector supplied				42" of usable #18-2, SPT-1-W leads. Cable connector supplied. Supply wire lugs attach directly to PAR 36 light bulb screw terminals. Light bulb secured in place with retaining ring																																																								
Mounting Acces. Included	8" In-ground stake				8" In-ground stake																																																								
Optional Mounting Accessories	15601 – Surface Mounting Flange 15607 – Surface Mounting Flange 15609 – Junction Box Mounting Bracket	15647 – 90° Elbow 15649 – Stem Coupler 15645, 15656, 15657, 15658 or 15570 – Stems	15601 – Surface Mounting Flange 15607 – Surface Mounting Flange 15609 – Junction Box Mounting Bracket	15647 – 90° Elbow 15649 – Stem Coupler 15645, 15656, 15657, 15658 or 15570 – Stems																																																									
Notes	See page 200 for photometrics				See page 200 for photometrics																																																								
Photometric with Supplied Lamp	<table border="1"> <thead> <tr> <th rowspan="2">A-Aiming Angle</th> <th colspan="3">0°</th> <th colspan="3">30°</th> <th colspan="3">45°</th> </tr> <tr> <th>D</th> <th>FC</th> <th>L</th> <th>W</th> <th>FC</th> <th>L</th> <th>W</th> <th>FC</th> <th>L</th> <th>W</th> </tr> </thead> <tbody> <tr> <td>5°</td> <td>8.76</td> <td>4.45</td> <td>4.45</td> <td>5.69</td> <td>6.36</td> <td>5.14</td> <td>3.1</td> <td>11.11</td> <td>6.3</td> <td></td> </tr> <tr> <td>10°</td> <td>2.19</td> <td>8.9</td> <td>8.9</td> <td>1.42</td> <td>12.71</td> <td>10.28</td> <td>.77</td> <td>22.21</td> <td>12.59</td> <td></td> </tr> <tr> <td>20°</td> <td>.55</td> <td>17.81</td> <td>17.81</td> <td>.36</td> <td>25.43</td> <td>20.56</td> <td>.19</td> <td>44.42</td> <td>25.19</td> <td></td> </tr> </tbody> </table>								A-Aiming Angle	0°			30°			45°			D	FC	L	W	FC	L	W	FC	L	W	5°	8.76	4.45	4.45	5.69	6.36	5.14	3.1	11.11	6.3		10°	2.19	8.9	8.9	1.42	12.71	10.28	.77	22.21	12.59		20°	.55	17.81	17.81	.36	25.43	20.56	.19	44.42	25.19	
A-Aiming Angle	0°			30°			45°																																																						
	D	FC	L	W	FC	L	W	FC	L	W																																																			
5°	8.76	4.45	4.45	5.69	6.36	5.14	3.1	11.11	6.3																																																				
10°	2.19	8.9	8.9	1.42	12.71	10.28	.77	22.21	12.59																																																				
20°	.55	17.81	17.81	.36	25.43	20.56	.19	44.42	25.19																																																				



 Denotes fixture is compatible with incandescent or LED lamps.

INCANDESCENT / LED 12V HYBRID ACCENT



15395 AZT - ADJUSTABLE WIDE FLOOD LIGHT

15396 AZT - MINIATURE HOODED ADJUSTABLE WIDE FLOOD LIGHT

Description	Large (6¾" x 5") floodlight with wide beam spread for dramatic up or down wall washing in a vertical installation.		Small (4½" x 5") eyebrow allows adjustment to upwards position without glare. Use for up or down wide-angle wall washing and young shrubs.									
Ordering Guide & Finish	15395 AZT – Textured Architectural Bronze		15396 AZT – Textured Architectural Bronze									
Housing	Cast Aluminum. Heat-resistant flat glass is fully sealed.		Cast Aluminum. Heat-resistant flat glass lens is fully sealed.									
Lamp Base	12V Incandescent bi-pin, high temperature porcelain socket 		12V Incandescent bi-pin, high temperature porcelain socket 									
Supplied Lamp	50-W(VA) QT4 (17015) Halogen light source		35-W(VA) QT3 (17013) Halogen light source									
Incandescent Lamp Options	Power usage at 12V AC input VA MAX: 75-W(VA) see page 161		Power usage at 12V AC input VA MAX: 35-W(VA) see page 161									
LED Lamp Options	N/A		N/A									
Wiring	35' of usable #18-2, SPT-1-W leads. Cable connector supplied		35' of usable #18-2, SPT-1-W leads. Cable connector supplied									
Mounting Acces. Included	8" In-ground stake		8" In-ground stake									
Optional Mounting Accessories	15601 – Surface Mounting Flange 15607 – Surface Mounting Flange 15609 – Junction Box Mounting Bracket	15647 – 90° Elbow 15649 – Stem Coupler 15645, 15656, 15657, 15658 or 15570 – Stems	15601 – Surface Mounting Flange 15607 – Surface Mounting Flange 15609 – Junction Box Mounting Bracket	15647 – 90° Elbow 15649 – Stem Coupler 15645, 15656, 15657, 15658 or 15570 – Stems								
Notes	See page 200 for photometrics		See page 200 for photometrics U.S. Patent Pending									
Photometric with Supplied Lamp	A	B	C	D	E	F	A	B	C	D	E	F
3'	9.30	5.43	1.81	.9	.18	.09	13.89	8.33	2.78	1.39	.28	.14
4'	5.08	3.05	1.01	.51	.10	.05	7.81	4.69	1.56	.78	.16	.08
5'	3.25	1.95	.65	.33	.07	.03	5	3	1	.5	.1	.05
6'	2.26	1.35	.45	.23	.05	.02	3.47	2.08	.69	.35	.07	.03
7'	1.66	.99	.33	.17	.03	.03	2.55	1.53	.51	.26	.05	.03
8'	1.27	.76	.25	.13	.03	.01	1.95	1.17	.39	.2	.04	.02
9'	1	.6	.2	.1	.02	.01	1.54	.93	.31	.15	.03	.02
10'	.81	.49	.16	.08	.02	.01	1.25	.75	.25	.13	.03	.01

 Denotes fixture is compatible with incandescent or LED lamps.

INCANDESCENT / LED 12V HYBRID ACCENT



15385 AZT - HOODED ADJUSTABLE WIDE FLOOD LIGHT

Description	Large (6¾" x 5") floodlight with wide beam spread for dramatic up or down wall-washing of taller walls and vertical stonework. Eyebrow shields glare to allow for horizontal use.					
Ordering Guide & Finish	15385 AZT – Textured Architectural Bronze					
Housing	Cast Aluminum. Heat-resistant flat glass lens is fully sealed.					
Lamp Base	12V Incandescent bi-pin, high temperature porcelain socket					
Supplied Lamp	50-W(VA) QT4 (17015) Halogen light source					
Incandescent Lamp Options	Power usage at 12V AC input VA MAX: 75-W(VA) Aluminum see page 161					
LED Lamp Options	N/A					
Wiring	35' of usable #18-2, SPT-1-W leads. Cable connector supplied					
Mounting Acces. Included	8" In-ground stake					
Optional Mounting Accessories	15601 – Surface Mounting Flange	15647 – 90° Elbow	15607 – Surface Mounting Flange	15649 – Stem Coupler	15609 – Junction Box Mounting Bracket	15645, 15656, 15657, 15658 or 15570 – Stems
Notes	See page 200 for photometrics U.S. Patent Pending					
Photometric with Supplied Lamp	A	B	C	D	E	F
3'	9.30	5.43	1.81	.9	.18	.09
4'	5.08	3.05	1.01	.51	.10	.05
5'	3.25	1.95	.65	.33	.07	.03
6'	2.26	1.35	.45	.23	.05	.02
7'	1.66	.99	.33	.17	.03	.03
8'	1.27	.76	.25	.13	.03	.01
9'	1	.6	.2	.1	.02	.01
10'	.81	.49	.16	.08	.02	.01

Denotes fixture is compatible with incandescent or LED lamps.

15395 AZT

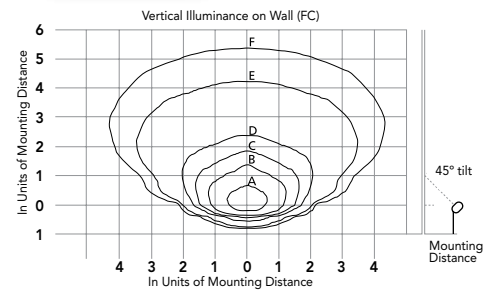

15396 AZT

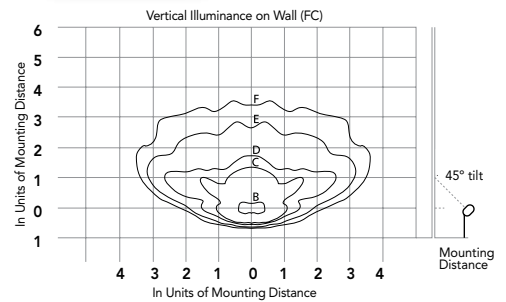

15385 AZT

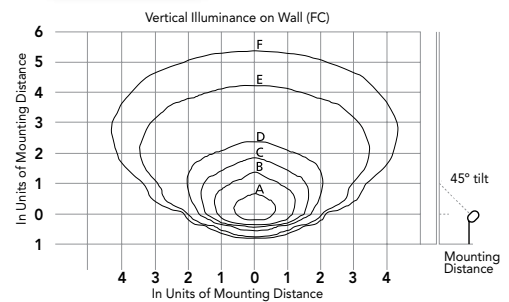

INCANDESCENT / LED 12V HYBRID ACCENT



15361 AZT. BKT - ADJUSTABLE WALL WASH

15363 BBR - ADJUSTABLE CAST BRASS WALL WASH

Description	Creates a low, even light spread to illuminate shrubs, plants or textured wall surfaces to silhouette special details.		Engineered for harsh weather conditions, including salt air. Creates a low, even light spread to illuminate shrubs, plants or textured wall surfaces to silhouette special details.																																																																			
Ordering Guide & Finish	15361 AZT – Textured Architectural Bronze 15361 BKT – Textured Black		15363 BBR – Bronzed Brass																																																																			
Housing	Cast Aluminum with clear polycarbonate shield		Cast Brass with clear polycarbonate shield																																																																			
Lamp Base	12V Incandescent S-8 wedge base socket		12V Incandescent S-8 wedge base socket																																																																			
Supplied Lamp	24.4-W(VA) 3156K (15598 CLR) Krypton light source		24.4-W(VA) 3156K (15598 CLR) Krypton light source																																																																			
Incandescent Lamp Options	Power usage at 12V AC input VA MAX: 24.4-W(VA) see page 161		Power usage at 12V AC input VA MAX: 24.4-W(VA) see page 161																																																																			
LED Lamp Options	N/A		N/A																																																																			
Wiring	42" of usable #18-2, SPT-1-W leads. Cable connector supplied		46" of usable #18-2, SPT-1-W leads. Cable connector supplied																																																																			
Mounting Acces. Included	8" In-ground stake		8" In-ground stake																																																																			
Optional Mounting Accessories	15601 – Surface Mounting Flange 15607 – Surface Mounting Flange 15609 – Junction Box Mounting Bracket	15647 – 90° Elbow 15649 – Stem Coupler 15645, 15656, 15657, 15658 or 15570 – Stems	15601 – Surface Mounting Flange 15607 – Surface Mounting Flange 15647 – 90° Elbow 15649 – Stem Coupler	15658 or 15570 – Stems 15645, 15657																																																																		
Photometric with Supplied Lamp	<table border="1"> <thead> <tr> <th>Distance from Wall</th> <th>0'</th> <th>1'</th> <th>2'</th> <th>3'</th> <th>4'</th> <th>5'</th> <th>6'</th> <th>7'</th> <th>8'</th> <th>9'</th> </tr> </thead> <tbody> <tr> <td>4'</td> <td>4.9</td> <td>3.6</td> <td>2.5</td> <td>1.6</td> <td>1.0</td> <td>.70</td> <td>.40</td> <td>.30</td> <td>.15</td> <td>.10</td> </tr> <tr> <td>8'</td> <td>1.2</td> <td>1.1</td> <td>.90</td> <td>.78</td> <td>.63</td> <td>.50</td> <td>.40</td> <td>.33</td> <td>.25</td> <td>.20</td> </tr> </tbody> </table>		Distance from Wall	0'	1'	2'	3'	4'	5'	6'	7'	8'	9'	4'	4.9	3.6	2.5	1.6	1.0	.70	.40	.30	.15	.10	8'	1.2	1.1	.90	.78	.63	.50	.40	.33	.25	.20	<table border="1"> <thead> <tr> <th>Distance from Wall</th> <th>0'</th> <th>1'</th> <th>2'</th> <th>3'</th> <th>4'</th> <th>5'</th> <th>6'</th> <th>7'</th> <th>8'</th> <th>9'</th> </tr> </thead> <tbody> <tr> <td>4'</td> <td>6.37</td> <td>4.68</td> <td>3.25</td> <td>2.08</td> <td>1.30</td> <td>.91</td> <td>.52</td> <td>.39</td> <td>.19</td> <td>.13</td> </tr> <tr> <td>8'</td> <td>1.60</td> <td>1.43</td> <td>1.17</td> <td>1.02</td> <td>.82</td> <td>.65</td> <td>.52</td> <td>.43</td> <td>.32</td> <td>.26</td> </tr> </tbody> </table>		Distance from Wall	0'	1'	2'	3'	4'	5'	6'	7'	8'	9'	4'	6.37	4.68	3.25	2.08	1.30	.91	.52	.39	.19	.13	8'	1.60	1.43	1.17	1.02	.82	.65	.52	.43	.32	.26
Distance from Wall	0'	1'	2'	3'	4'	5'	6'	7'	8'	9'																																																												
4'	4.9	3.6	2.5	1.6	1.0	.70	.40	.30	.15	.10																																																												
8'	1.2	1.1	.90	.78	.63	.50	.40	.33	.25	.20																																																												
Distance from Wall	0'	1'	2'	3'	4'	5'	6'	7'	8'	9'																																																												
4'	6.37	4.68	3.25	2.08	1.30	.91	.52	.39	.19	.13																																																												
8'	1.60	1.43	1.17	1.02	.82	.65	.52	.43	.32	.26																																																												

Denotes fixture is compatible with incandescent or LED lamps.

INCANDESCENT / LED 12V HYBRID ACCENT



15087 AZT - MR-16 MINI ACCENT (DOWN) **15093 WHT - MR-16 MINI ACCENT (DOWN)** **15494 AZT - LONG COWL MINI-ACCENT**

Description	Tree or surface mount for downlight application. Features open stainless steel lamp protection. For downlight use only.	Tree or surface mount for downlight application. Features open stainless steel lamp protection. For downlight use only.	A compact accent light with extra long cowl. Up or down lighting.
Ordering Guide & Finish	15087 AZT – Textured Architectural Bronze	15093 WHT – Textured White	15494 AZT – Textured Architectural Bronze
Housing	Cast Aluminum with stainless steel screen.	Cast Aluminum with Stainless Steel screen.	Cast Aluminum. Heat-resistant flat glass lens is fully sealed.
Lamp Base	12V Incandescent bi-pin, high temperature porcelain socket	12V Incandescent bi-pin, high temperature porcelain socket	12V Incandescent bi-pin, high temperature porcelain socket
Supplied Lamp	Lamp not supplied unless noted	Lamp not supplied unless noted	Lamp not supplied unless noted
Incandescent Lamp Options	Power usage at 12V AC input VA MAX: 50-W(VA) MR-16 20-W(VA) Max. Canada 35-W(VA) MR-11 see page 161	Power usage at 12V AC input VA MAX: 50-W(VA) MR-16 20-W(VA) Max. Canada 35-W(VA) MR-11 see page 161	Power usage at 12V AC input VA MAX: 50-W(VA) MR-16 20-W(VA) Max. Canada 35-W(VA) MR-11 see page 161
LED Lamp Options	4W (18000-18011) see page 159 Compares to 20W Halogen 6W (18012-18020) see page 159 Compares to 35W Halogen	4W (18000-18011) see page 159 Compares to 20W Halogen 6W (18012-18020) see page 159 Compares to 35W Halogen	4W (18000-18011) see page 159 Compares to 20W Halogen 6W (18012-18020) see page 159 Compares to 35W Halogen
Wiring	35" of usable #18-2, SPT-1-W leads. Cable connector supplied	35" of usable #18-2, SPT-1-W leads. Cable connector supplied. 12V porcelain universal bi-pin socket	35" of usable #18-2, SPT-1-W leads. Connector supplied
Mounting Acces. Included	15607 – Surface Mounting Bracket	15607 – White Surface Mounting Bracket and Hardware	15609 – Junction Box Mounting Bracket
Optional Mounting Accessories	15601 – Surface Mounting Flange 15609 – Junction Box Mounting Bracket 15647 – 90° Elbow 15649 – Stem Coupler 15645, 15656, 15657, 15658 or 15570 – Stems	N/A	15601 – Surface Mounting Flange 15607 – Surface Mounting Flange 15647 – 90° Elbow 15649 – Stem Coupler 15645, 15656, 15657, 15658 or 15570 – Stems
Optional Lens Accessories	N/A	N/A	15675 LIN – Linear Lens 15676 FRO – Frosted Glass 15679 BK – Louver 15686 BL – Blue Filter
Notes	See page 200 for photometrics	See page 200 for photometrics	See page 200 for photometrics

Denotes fixture is compatible with incandescent or LED lamps.





KICHLER®

Incandescent / LED 12V Hybrid In-Ground

Bring the light center stage.



INCANDESCENT/LED 12V HYBRID IN-GROUND

INCANDESCENT/LED 12V HYBRID IN-GROUND

W



15488 BK, 15488 BK12 - RUBBER BOOT HELD PAR 36 WELL LIGHT **15088 BK, 15088 BK12 - YOKE HELD PAR 36 WELL LIGHT**

Description	Flush mounted or angled uplighting effects when semi-recessed.	Versatile design with reversible support sleeve to accommodate uplighting when flush mounted or angled lighting effects when semi-recessed. Stainless steel gimble ring design holds lamp securely at desired angle.
Ordering Guide	15488 BK - Black 15488 BK 12 - Same as 15488 BK. Bulk packed in 12 (unbreakable master)	15088 BK - Black 15088 BK 12 - Same as 15088 BK. Bulk packed in 12 (unbreakable master) 15388 BK - Same as 15088 BK. 35-W PAR-36 included
Housing	Silicone rubber lamp holder. Heavy-duty polycarbonate ground support sleeve.	Stainless steel gimble ring with silicone rubber lamp support clips. Heavy-duty polycarbonate ground support sleeve.
Lamp Base	12V PAR 36 lamp	12V PAR 36 lamp
Supplied Lamp	35-W (VA) PAR 36 wide flood (supplied and installed) Halogen light source Power usage at 12V AC input VA MAX: 50-W(VA)	Lamp not supplied unless noted. Power usage at 12V AC input VA MAX: 36-W(VA)
Incandescent Lamp Options	NA	NA
LED Lamp Options	11W PAR36/AR111 (18021-18029) see page 159 Compares to 50W Halogen	11W PAR36/AR111 (18021-18029) see page 159 Compares to 50W Halogen
Wiring	39" of usable #18-2, SPT-1-W leads. Cable connector supplied. Supply wire with lugs attach directly to PAR 36 light bulb screw terminals	42" of usable #18-2, SPT-1-W leads. Cable connector supplied. Supply wire with lugs attach directly to PAR 36 light bulb screw terminals
Optional Lens Accessories	NA	15689 BK - Lens Cover 15690 BK - Rock Guard
Notes	See page 200 for photometrics	See page 200 for photometrics

Denotes fixture is compatible with incandescent or LED lamps.

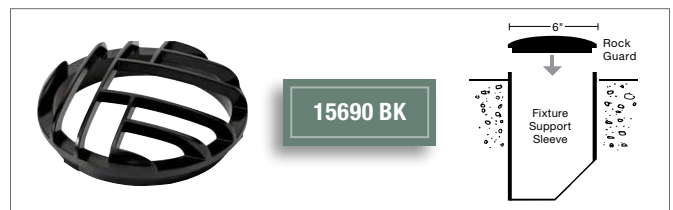

15690 BK snaps easily into place on flat side of fixture's sleeve.

Lens Accessory 15689 BK available for Well Light 15088 and 15388.
Heat-resistant glass lens provides protection from sprinklers and lawn debris.

INCANDESCENT/LED 12V HYBRID IN-GROUND



15194 AZ - ENCLOSED PAR 36 WELL

15190 BK - MR16 MINI WELL

Description	Completely sealed well light creates unique lighting effects and reduces maintenance with Rock Guard/Glare Shield accessory (15694 AZ) on page 152.	Smaller version of our popular standard well light to shed focused upwards illumination on special features in the landscape. Recommended for salt-air environments.
Ordering Guide	15194 AZ - Architectural Bronze™	15190 BK - Black
Housing	Durable high temperature polymeric housing material. Glass lens for watertight outdoor inground use.	Durable high heat thermo-plastic composite resin. Heat resistant convex shaped glass lens. Fully sealed for watertight outdoor usage.
Lamp Base	12V PAR 36 lamp	12V bi-pin, high temperature porcelain socket
Supplied Lamp	Lamp not supplied unless noted Power usage at 12V AC input VA MAX: 50-W(VA) 50-W(VA) PAR 36	Lamp not supplied unless noted Power usage at 12V AC input VA MAX: 50-W(VA) 50-W(VA) MR-16: 35-W(VA) Max. MR-11
Incandescent Lamp Options	N/A	N/A
LED Lamp Options	11W PAR36/AR111 (18021-18029) see page 159 Compares to 50W Halogen	4W (18000-18011) see page 159 Compares to 20W Halogen
Wiring	34" of usable #18-2, SPT-1-W leads. Cable connector supplied. Supply wire with lugs attach directly to PAR 36 light bulb screw terminals	36" of usable #18-2, SPT-1-W leads. Cable connector supplied
Optional Lens Accessories	15694 - Rock Guard	N/A
Notes	See page 200 for photometrics	U.S. Patent No. D437,652 See page 200 for photometrics



Denotes fixture is compatible with incandescent or LED lamps.

INCANDESCENT/LED 12V HYBRID IN-GROUND



15192 BK - MR16 MINI WELL WITH COWL

15092 BK - MR16 WELL

Description	Same as 15190 with added glare shield for optimal viewing comfort. Recommended for salt air environments.	Versatile design with reversible support sleeve to accommodate uplighting when flush mounted or angled lighting effects when semi-recessed. Heavy-duty polypropylene sleeve provides in-ground support.
Ordering Guide	15192 BK – Black	15092 BKT – Textured Black
Housing	Components of durable high heat thermoplastic composite resin. Glare shield molded into lid. Light bulb shielded by a heat-resistant convex shaped glass lens for better debris run-off. Fully sealed for watertight outdoor usage.	Aluminum housing with heat resistant flat glass lens is fully sealed. Heavy duty polypropylene sleeve provides in-ground fixture support.
Lamp Base	12V bi-pin, high temperature porcelain socket 	12V bi-pin, high temperature porcelain socket 
Supplied Lamp	Lamp not included unless noted Power usage at 12V AC input VA MAX: 50-W(VA) 50-W(VA) MR-16 10-W(VA) MAX Canada 35-W(VA) Max. MR-11	Lamp not included unless noted Power usage at 12V AC input VA MAX: 50-W(VA) 50-W(VA) MR-16
Incandescent Lamp Options	N/A	N/A
LED Lamp Options	4W (18000-18011) see page 159 Compares to 20W Halogen	4W (18000-18011) see page 159 Compares to 20W Halogen 6W (18012-18020) see page 159 Compares to 35W Halogen
Wiring	36" of usable #18-2, SPT-1-W leads. Cable connector supplied	38" of usable #18-2, SPT-1-W leads. Cable connector supplied
Optional Lens Accessories	N/A	15675 LIN – Linear Lens 15676 FRO – Frosted Lens 15679 BK – Hexcell Louver Shield 15686 BL – Blue Filter
Notes	See page 200 for photometrics	See page 200 for photometrics

 Denotes fixture is compatible with incandescent or LED lamps.

Incandescent / LED 12V Hybrid Water Feature Lighting

The perfect concert of sound, movement and light.





15191 BK - UNDERWATER LIGHT

Description	Creates dramatic effects in or near water features.
Ordering Guide	15191 BK - Black
Housing	Components of durable high heat thermoplastic composite resin. Heat-resistant flat glass lens is fully sealed. Weighted base included.
Lamp Base	12V bi-pin, high temperature porcelain socket 
Supplied Lamp	Lamp not included unless noted
Incandescent Lamp Options	Power usage at 12V AC input VA MAX: 50-W(VA) MR-16 35-W(VA) Max. MR-11
LED Lamp Options	4W (18000-18011) see page 159 Compares to 20W Halogen
Wiring	25' of #18-2, STW leads
Notes	See page 200 for photometrics Note: NOT for pool and spa use

 Denotes fixture is compatible with incandescent or LED lamps.

Incandescent / LED 12V Transformers

Power to perform with incandescent and LED fixtures.



RELIABLE

- Runs feature one common transformer per circuit. ANSI/UL1838 requirements limit each circuit to 300-W and 15V.
- Secondary circuit breakers offer short-circuit protection as a standard feature.
- Magnetic circuit breakers provide a faster response to a fault in the system.
- An in-line primary thermostat protects against thermal over-load. These built-in thermostats are auto-resetting, eliminating the need for replacement or maintenance.
- Because compliance and safety are important long after the installation is complete all Kichler® Landscape Lighting low voltage transformers are listed or certified by UL, ETL, and/or CSA to the appropriate ANSI/UL 1838 standard for both the United States and Canada.
- Internal wiring is rated for 150°C (302°F), which exceeds safety standard requirements and provides longer life.

POWERFUL

- Various wattage options are available including: 60, 75, 100, 120, 200, 300, 600, 900, and 1200 in many options.
- Available in premium or economy options – convenient for larger, more complicated jobs or where smaller profile, lower-wattage units can be used.

DURABLE

- Full enclosure of the housing protects components from weather, sprinkling systems and debris.
- Professional Series housings are made of stainless steel grade 304 designed to run cooler and resist corrosion and last longer in outdoor environments.
- Multi-tap transformers allow greater flexibility in managing multiple wire runs by moving cables up and down the multi-range. This assures that the correct voltage is applied to a lamp – creating a consistent light output and maximizing lamp life.

DEPENDABLE

- Every tap is tested on the assembly line to ensure that output is consistently accurate.
- Installation is simplified, thanks to 30°-tilted taps mounted on the 125-Amp terminal board. This provides more space and greater visibility while inserting cables into taps.
- Units can be loaded up to the full maximum watts, including cable length, fixtures and cable loss. For ease in calculating runs, Kichler provides a Voltage Drop Tool that features pull-down menus and professional printouts for recordkeeping.

WARRANTY

- Limited lifetime warranty offered on Stainless Steel (SS) transformer models.
- A limited 10-Year Warranty on powder-coated Textured Architectural Bronze™ (AZT) transformer models.

CORE AND COIL CONSTRUCTION

All core and coil-types used in Kichler transformers, except economy series, feature epoxy encapsulation. This provides commercial-grade benefits such as:

- **PROTECTION:** Core, wire leads and inner parts are set inside epoxy to prevent exposure to moisture to resist corrosion and maintain a permanent seal.
- **QUIET:** Humming noises are eliminated, as well as vibration, keeping connections from loosening.
- **COOL:** Epoxy also keeps unit running cooler. Running cooler at full load is safer and conserves energy.

OTHER IMPORTANT INSTALLATION CONSIDERATIONS:

- National Electric Code and Underwriters Laboratories (UL) require that wiring, where concealed or extended through a building wall, must be enclosed in conduit.
- All Kichler transformers are rated for use with ANSI/UL 1838 listed fixtures including those for underwater use. Kichler transformers are NOT rated for use with fixtures for pools, spas, or bodies of water intended for immersion of humans.

TIP ON PRIMARY POWER:

Since 120-Volts can vary depending on time of day and local utility fluctuations, always measure the voltage on the primary side before and during job installation. Transformers reduce primary input in a ratio of 10:1 – Ex: 120 Volts:12 Volts.



High Efficient E.I. core and coil configuration is standard on most Kichler models

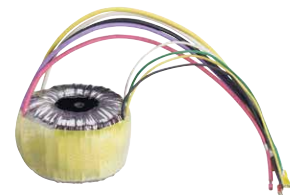

15PR75SS, 15PR900SS, 15PR1200SS, 15PL75AZT and 15PL900AZT feature high efficiency Toroid core and coil configuration

12V TRANSFORMERS



PROFESSIONAL SERIES PR



OPTIMIZED
FOR LED
FIXTURES

PROFESSIONAL SERIES PR

<p>Description</p>	<p>Kichler's Professional Series provides the best options and flexibility needed for most installations. Output voltage range will suit most jobs. Features include a commercial grade core and coil, pluggable timer and photocell outlets, plus a lifetime warranty</p> <p>For details see chart on page 142.</p>	<p>75W Professional Series transformer is ideal for use with Kichler Design Pro LED low voltage fixtures.</p> <p>For details see chart on page 142.</p>
<p>Features</p>	<ul style="list-style-type: none"> • Output voltage taps 12/13/14/15 Volts • Installation is made easy with 30° tilted taps mounted on a 125-Amp terminal board because there is more space and greater visibility while inserting cables into taps • Tilted terminal board and large capacity lugs inside the taps hold up to 8, #10-gauge wires or up to 10, #12-gauge wires per tap • In-line secondary magnetic breaker protects against short circuit • Fully enclosed housing constructed of #304 grade stainless steel • Epoxy encapsulant for greater protection and performance • Drop down bottom panel with four pre-punched field knockouts sized for 1/2" or 3/4" conduit (trade sizes) and one large center 1-3/4" inlet • Professional Series units feature high efficiency E.I. core and coil and dedicated wire loop for quick access testing of primary load. This provides the best reliability and maintains improved regulation from no load to full load. High efficiency E.I. offers comparable efficiency to toroid models. High-efficiency E.I. run cooler because heat dissipates, run quieter since there's no hum, and run smoother due to less vibration • 900-W and 1200-W units feature high efficiency Toroid core and coils • 900-W and 1200-W Professional Series units feature relay (contactor), which reduces current amp draw through the timer, photocell, and receptacle – extending the life of these components • Mounting brackets are welded and riveted in place for extra strength Mounting plate for indoor use is included. Transformers used indoors require cable to be routed through conduit. Check local government ordinances and codes to ensure proper standards are met • Compatible with plug-in timer and plug-in photocells • Limited lifetime warranty 	<ul style="list-style-type: none"> • Output voltage tap 15V only for simplified LED installations • In-line secondary magnetic breaker protects against short circuit • Epoxy encapsulant for greater protection and performance • Fully enclosed housing constructed of #304 grade stainless steel • Features high efficiency Toroid core and coil • Mounting brackets are welded and riveted in place for extra strength. Mounting plate for indoor use is included. Transformers used indoors require cable to be routed through conduit. Check local government ordinances and codes to ensure proper standards are met • Limited lifetime warranty

12V TRANSFORMERS



PROFESSIONAL SERIES 2-IN-1 PR



PLUS SERIES PL

<p>Description</p>	<p>The Professional Series 2-In-1 Transformer provides one distinct model designed for unique applications where two separate 300-W circuits (zones) and control options are needed within the same housing</p> <p>For details see chart on page 142.</p>	<p>Kichler's Plus Series Transformers feature a 6' cord, pluggable options and a powder coated steel case</p> <p>For details see chart on page 142.</p>
<p>Features</p>	<ul style="list-style-type: none"> • 2 separate sets of multi-tap output – 12V, 13V, 14V, 15V on each circuit • 600-W total power and (2) independently controlled 300-W transformers for 2 separate scenes • (2) independent receptacles for pluggable photocells for multiple on/off options • (2) independent receptacles for pluggable timers • Limited lifetime warranty 	<ul style="list-style-type: none"> • Output voltage taps are 12V, 13V, 14V, 15V, 80 Amp. Max. per board • Powder-coated housing is painted steel with AZT finish • Auto-resettable in-line primary overload protection • An in-line secondary magnetic breaker protects against short circuiting • Epoxy encapsulated for greater protection and performance • Compatible with plug-in timer and plug-in photocells • Mounting template included • 10-year limited warranty

12V TRANSFORMERS

	 <p>OPTIMIZED FOR LED FIXTURES</p> <p>PLUS SERIES PL</p>	 <p>MANUAL SERIES M</p>	 <p>ECONOMY SERIES E</p>
Description	<p>75W Plus Series transformer is ideal for use with Kichler Design Pro LED low voltage fixtures. For details see chart on page 142.</p>	<p>Kichler's Manual Series Transformers are the ideal solution when on/off switching is desired from a switched electrical outlet. Timers and photo-cells are not offered as options for this unit. For details see chart on page 142.</p>	<p>Kichler's Economy Series Transformers for small jobs or single specialty piece applications. Built in photocell, timer and high-low switch. For details see chart on page 142.</p>
Features	<ul style="list-style-type: none"> • Output voltage tap 15V only for simplified LED installations. • In-line secondary magnetic breaker protects against short circuit • Epoxy encapsulant for greater protection and performance • Powder-coated housing is painted steel with AZT Finish • Features high efficiency Toroid core and coil • Mounting brackets are welded and riveted in place for extra strength. Mounting plate for indoor use is included. Transformers used indoors require cable to be routed through conduit. Check local government ordinances and codes to ensure proper standards are met • 10-year limited warranty 	<ul style="list-style-type: none"> • Output voltage taps are 12V, 13V, 15V only on 15M300 AZT and 15M600 AZT. 15M100 AZT and 15M200 AZT are single 12V taps • Epoxy encapsulated for greater protection and performance • An in-line secondary thermal or magnetic breaker protects against short circuiting • Auto-resettable in-line primary overload protection • 10-year limited warranty 	<ul style="list-style-type: none"> • High and Low output settings • Integral timer and photocell • Durable black polymeric enclosure resists corrosion • An in-line push button thermal breaker on the secondary protects against short circuiting. • Auto-resettable in-line primary overload protection • 10-year limited warranty

12V TRANSFORMER ACCESSORIES

Mechanical Transformer Timer



15557 BK

See Page 153

Plug-In Transformer Photocell



Photocells should be faced out (not up) for optimum life

15565 BK

See Page 153

Digital Transformer Timer



15556 WH

Integrated battery backup
See Page 153

Synchronizer Device



15511 BK

See Page 153

Remote Plug-In Transformer Photocell



Photocells should be faced out (not up) for optimum life.

10' cord

15534 BK

See Page 153

TRANSFORMER ACCESSORIES

Along with a wide variety of transformers, Kichler offers a full complement of control accessories. Used separately or in tandem; light may be controlled as desired.

Photocells allow the intensity of daylight to define transformer operation. Timers can be used for more exacting requirements. Regardless of which is chosen, each will assist the transformer in providing the desired result.

12V TRANSFORMERS

	PROFESSIONAL								PLUS						MANUAL				ECO	
	15PR75 SS	15PR100 SS	15PR200 SS	15PR300 SS	15PRD600 SS ²⁻ⁱⁿ⁻¹	15PR600 SS	15PR900 SS	15PR1200 SS	15PL75 AZT	15PL100 AZT	15PL200 AZT	15PL300 AZT	15PL600 AZT	15PL900 AZT	15M100 AZT	15M200 AZT	15M300 AZT	15M600 AZT	15E60 BK	15E120 BK
	16.5"x5.5"x5.75"	19"x5.5"x5.75"	19"x5.5"x5.75"	19"x5.5"x5.75"	21.25"x6.75"x5.75"	19"x6.75"x5.75"	21"x6.75"x6"	17.5"x8"x7"	16.5"x5.5"x5.75"	19"x5.5"x5.75"	19"x5.5"x5.75"	19"x5.5"x5.75"	19"x6.75"x5.75"	21"x6.75"x6"	8"x3.25"x3"	13.25"x3.5"x4"	13.5"x4.5"x4"	14.25"x5.5"x5"	6.75"x3.75"x3.75"	6.75"x3.75"x3.75"
Wattage (VA)	75	100	200	300	600	600	900	1200	75	100	200	300	600	900	100	200	300	600	60	120
Automatic Timer	●	●	●	●	●	●	●	●	●	●	●	●	●	●					●	●
Photo Electric Eye	●	●	●	●	●	●	●	●	●	●	●	●	●	●					●	●
High-Low Switch																			●	●
On-Off-Auto Switch																			●	●
Multi-Tap Connection 12V, 13V, 15V																	●	●		
Multi-Tap Connection 12V, 13V, 14V, 15V		●	●	●	●	●	●	●	●	●	●	●	●	●						
Single-Tap Connection 15V	●								●											
Thermal Cut-Off on Primary Side	●	●	●	●	●	●	●	●	●	●	●	●	●	●		●	●	●	●	●
Thermal Reset Breaker on Secondary Side														●	●				●	●
Magnetic Breaker on Secondary Side	●	●	●	●	●	●	●	●	●	●	●	●	●	●			●	●		
Easy Connect Terminal Blocks	●	●	●	●	●	●	●	●	●	●	●	●	●	●		●	●	●		
6', 3-Wire #14-GA SJTW Cord								●												
6', 3-Wire #16-3 SJTW Cord					●	●	●						●	●			●			
6', 3-Wire #18-3 SJTW Cord	●	●	●	●					●	●	●	●			●	●	●			
6', 2-Wire #18-2 SJTW Cord																			●	●
Includes Mounting Plate for Indoor Use	●	●	●	●	●	●	●	●	●	●	●	●	●	●						
Textured Architectural Bronze or Powder Coat									●	●	●	●	●	●	●	●	●	●		
#304 Grade Stainless Steel	●	●	●	●	●	●	●	●												
Composite Housing																			●	●
10-Year Limited Warranty									●	●	●	●	●	●	●	●	●	●	●	●
Lifetime Warranty	●	●	●	●	●	●	●	●												
High Efficiency E.I. Core and Coil Configuration		●	●	●		●				●	●	●	●		●	●	●	●	●	●
High Efficiency Toroid Core and Coil Configuration	●				●		●	●	●					●						



● = Included
● = Optional

12V TRANSFORMERS

600-W, 900-W and 1200-W Transformer models are manufactured in intervals of 300-W (VA) circuits.

National Electric Code and Underwriters Laboratories require that wiring, where concealed or extended through a building wall, must be enclosed in conduit.

All transformers are for use with outdoor low voltage lighting.

   All Kichler transformers are listed or certified to ANSI/UL 1838 The listing/certification agency may vary.

IMPORTANT: These units are not approved for use with fixtures placed within 10' of swimming pools or spas.

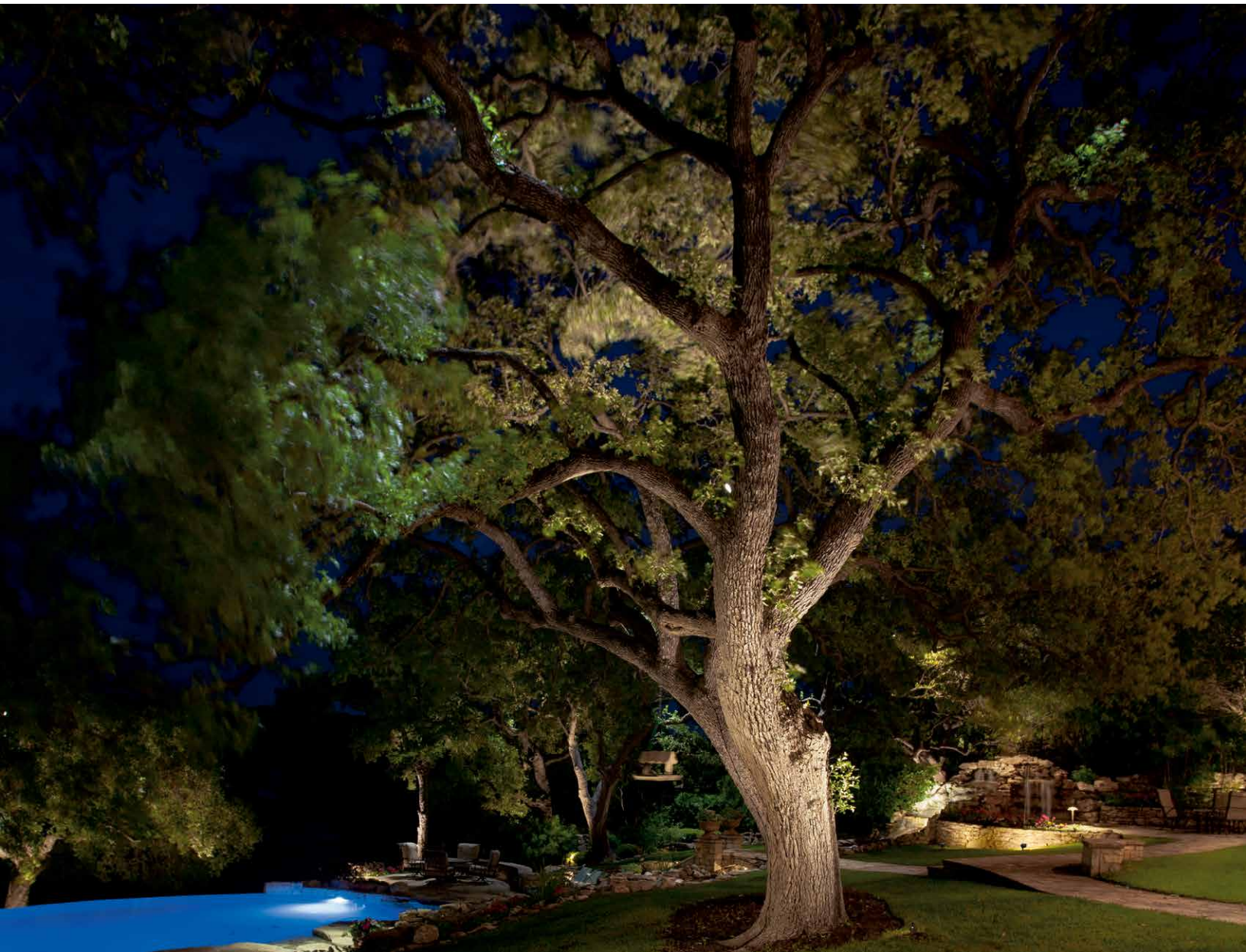





KICHLER®

Incandescent / LED 12V Accessories

Genuine Kichler® low voltage accessories.





BLAZING
INSTALL FASTER

15529 BL - PRO SERIES WIRE CONNECTOR

Description	Now, there's an alternate to silicone-filled wire connectors, soldered wire connections and costly shrink-wrap connections. Kichler® exclusively offers the Pro Series Wire Connector – a reliable, quality connection that will compliment your installation of premium Kichler® landscape lighting. Developed in concert with Blazing Products, Inc, this new method of making 12V connections is safer, faster, more reliable, and exclusive to Kichler.
Ordering Guide & Finish	15529 BL – Bulk pack of 100 connectors in sealed bags of 10 ANSI/UL 486 D Sealed wire connector system. Sealed wire connector for direct burial applications
Safer & Faster	<ul style="list-style-type: none"> • Drastically reduces the potential for arcing • Improves safety and speed of installation
More Reliable	<ul style="list-style-type: none"> • Gel filled connection and semi-permanent seal provides a watertight long-lasting connection • Has a stronger strain relief (up to 30 lbs. of force) for a more secure connection • Stranded wire torques around metal insert • Reduces callbacks due to connections that become loose • An access hole for a voltmeter probe is integrated in each Pro Series Connector



Packed in sealed bags of 10

STEP 1

- Turn power off.
- Rotate wings fully apart.



STEP 2

Using the strip guide molded into the connector for reference, strip the wire to 11/16".



STEP 3

Insert wires into connector so that they are bottomed out. Connector must be open.

- #12 in large holes
- #18 in small holes



Repeat for second connector as part of complete splice.

STEP 4

(Optional if testing voltage at fixture) Turn power back on. With connector still open halfway, push voltmeter probe into connector probe port. Push probe all the way in and repeat on other connector.







STEP 5



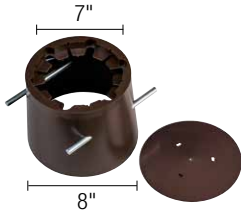
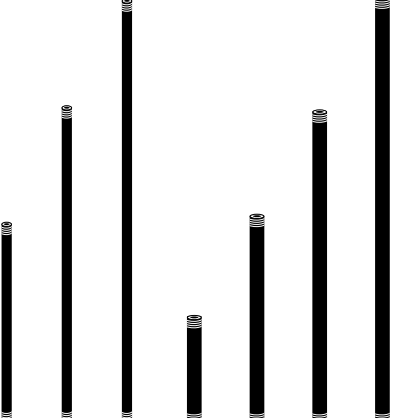

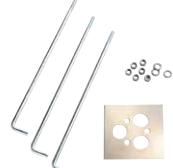



Hold wires in place while squeezing handles together until the connector snaps shut. Use pliers if necessary to close. Repeat on other connector.













INCANDESCENT / LED 12V ACCESSORIES

MOUNTING ACCESSORIES	ITEM NUMBER		NOTES
<p>Concrete Installation Kit</p>  <p>POWERED BY DESIGN PRO LED TECHNOLOGY</p> <p>WITH Radiax OPTICS</p>	16501 BBRP		<ul style="list-style-type: none"> • Drive-over and walk-over rated to 4,500 lbs. • Throw-away debris lid • Includes two steel support rods <p>For use with fixtures 4W, 6.5W & 14W – 16030, 16031, 16032, 16033, 16034, 16035, 16036, 16037, 16038</p>
<p>Fixture Mounting Stems</p> 	<p>1/4-18 NPSM THD. STEMS .5" DIA. OVERALL</p> <p>12" 15651 AZT 15651 BKT</p> <p>18" 15652 AZT 15652 BKT</p> <p>24" 15653 AZT 15653 BKT</p> <p>Reference fixture specifications for proper stem</p>	<p>1/2-14 NPSM THD. STEMS .75" DIA. OVERALL</p> <p>6" 15645 AZT 15645 BBR 15645 BKT</p> <p>12" 15656 AZT 15656 BBR 15656 BKT</p> <p>18" 15657 AZT *15657 BBR 15657 BKT</p> <p>24" 15658 AZT 15658 BBR 15658 BKT</p>	<p>All stems made of corrosion resistant aluminum alloy (except BBR, which is Cast Brass) with baked thermoset powder coating to match fixtures</p> <p>Used with:</p> <ul style="list-style-type: none"> • In-ground support stakes (low voltage only) • Surface mounting flange (low or line voltage) <p>1/2-14 NPSM stems will require additional Coupler (15649) or Elbow (15647) for accent light use</p>
<p>Adjustable Height Stems</p>  <p>Extends from 18" to 33"</p>	15570 AZT 15570 BKT		<p>For use with most 12V accent fixtures</p> <p>Corrosion resistant aluminum alloy with baked thermoset powder coat finish</p> <p>Stem allows fixture height to be extended for plant growth. Used with in-ground support stakes (order separately)</p> <ul style="list-style-type: none"> • 1/2-14 NPSM thds.
<p>Bollard Mounting Kit</p>  <p>4.0625" ID 4.25" OD</p>	<p>18" 15665 AZT 15665 BKT</p> <p>24" 15666 AZT 15666 BKT</p> <p>36" 15667 AZT 15667 BKT</p>		<p>For use with fixtures 15005, 15011, 15205, 15211</p> <p>Bollard kit is supplied with cast aluminum internal mounting plate including lag bolts for deck or surface mounting. Extruded aluminum bollard finished with baked thermoset powder coat. Order separate bollard template kit for installation into concrete or bollard mounting stake for installation in soil. UL and CSA listed</p>
<p>Bollard Template Kit</p> 	15671 ST		<p>For use with all bollard mounting kits</p> <p>For permanent installation into concrete. Template kit includes positioning template, anchor bolts, and mounting hardware.</p>
<p>Bollard Mounting Stake</p>  <p>23" H</p>	15578 BK		<p>For use with all bollard mounting kits on 12V and 120V fixtures.*</p> <p>Improved extruded PVC stake is corrosion resistant and 23" length has increased support and stability. Fitting provided to mount bollard in soil.</p> <p>*As allowed by local electrical codes</p>
<p>Polymeric Support Stakes</p>  <p>8" H & 14" H</p>	<p>15575 BK 8" In-ground Stake</p> <p>15576 BK 14" In-ground Stake</p>		<p>For use with 12V fixtures</p> <p>Injection molded stakes are corrosion resistant and provide maximum support and stability</p> <p>U.S. Patent No. D415,018</p>





INCANDESCENT / LED 12V ACCESSORIES

MOUNTING ACCESSORIES	ITEM NUMBER	NOTES
<p>Elbow</p> <p>1.18" W 2.09" H 1.35" L</p> 	<p>15647 AZT 15647 BBR 15647 BKT</p>	<p>When combined with a stem, this accessory creates a 90° angle to offer more ways to utilize our accent fixtures as a path, area or down light. Cast Aluminum or Cast Brass housing. Textured Architectural Bronze, Bronzed Brass or Textured Black finish. Stabilizer set screw included.</p>
<p>Stem Coupler</p> <p>1/2-14 NPSM thd. 1.5" H</p> 	<p>15649 AZT 15649 BBR 15649 BKT</p>	<p>Aluminum (except BBR, which is Brass) coupler. For use with 1/2" NPSM stems.</p>
<p>Surface Mounting Flange</p> <p>4" D 1/2-14 NPSM thd.</p> 	<p>15601 AZT 15601 BBR 15601 BKT 15601 WHT</p>	<p>For 12V or 120V installations, surface flange must be used with junction box (not included). Neoprene gasket supplied to ensure water tight seal.</p> <p>BBR is Bronzed Cast Brass AZT, BKT and WHT are Cast Aluminum</p>
<p>Flange Mounting Nipple</p> <p>1" x 1/2-14 NPSM thd.</p> 	<p>15602 AL</p>	<p>Anodized aluminum nipple. Used when attaching fixture directly to 15601 flange and 15607 bracket.</p>
<p>Surface Mounting Bracket</p> <p>1.5" x 2.5" x 1" 1/2-14 NPSM thd.</p> 	<p>15607 AZT 15607 BBR 15607 BKT 15607 WHT</p>	<p>For use with low voltage fixtures</p> <p>Corrosion resistant Cast aluminum alloy with baked thermoset powder coat finish. Low voltage only.</p> <p>BBR is Bronzed Cast Brass</p>
<p>1 LED Hardscape Bracket</p> 	<p>15716 SS Use with fixture 15734, 15744</p>	<p>Brackets mount to parallel surfaces and hold fixture in place. For use in hardscape installations where the masonry plate cannot be used or in non-hardscape applications where there is no or inadequate overhang surface area. Mounting hardware included.</p>
<p>3 LED Flat Mounting Bracket</p> 	<p>15717 SS Use with fixture 15735, 15745</p>	<p>Brackets mount to parallel surfaces and hold fixture in place. For use in hardscape installations where the masonry plate cannot be used or in non-hardscape applications where there is no or inadequate overhang surface area. Mounting hardware included.</p>
<p>6 LED Flat Mounting Bracket</p> 	<p>15718 SS Use with fixture 15736, 15746</p>	<p>Brackets mount to parallel surfaces and hold fixture in place. For use in hardscape installations where the masonry plate cannot be used or in non-hardscape applications where there is no or inadequate overhang surface area. Mounting hardware included.</p>
<p>9 LED Flat Mounting Bracket</p> 	<p>15719 SS Use with fixture 15755, 15756</p>	<p>Brackets mount to parallel surfaces and hold fixture in place. For use in hardscape installations where the masonry plate cannot be used or in non-hardscape applications where there is no or inadequate overhang surface area. Mounting hardware included.</p>
<p>Out of Water Bracket</p> <p>2.52" W</p> 	<p>15777 SS Use with fixture 15711 SS U.S. Patent Pending</p>	<p>Stainless steel easy mount bracket for use above ground on any surface – ideal for wood and masonry when used on decks, patios or overhangs.</p>





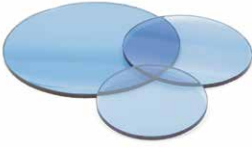
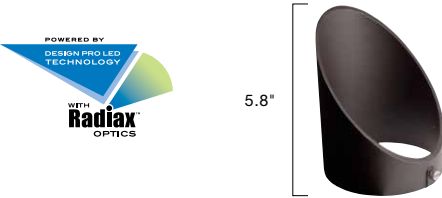
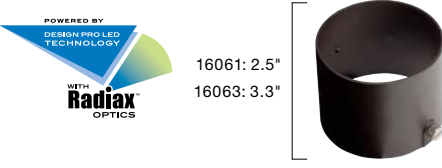

INCANDESCENT / LED 12V ACCESSORIES

MOUNTING ACCESSORIES		ITEM NUMBER	NOTES
Multi-Fixture Weighted Base  3.375" W	15776 BK	Use with fixture 15711 SS	Heavy weighted 3 pronged underwater accessory for 2 or 3 fixtures to give maximum flexibility and directional capability
Single Fixture Weighted Base  3.375" W	15778 BK	Use with fixture 15711 SS	Heavy weight 1 prong underwater light accessory for standard installations. Provides advanced directional capability.
Junction Box Mounting Bracket  2.39" W 5.56" H	15609 AZT 15609 BKT 15609 WHT	Use with 12V and 120V fixtures	Corrosion resistant Cast Aluminum alloy with baked thermoset powder coat finish
Three Fixtures, Centerpiece Mounting Kit  6" W 14" L	15635 OZ	for use with 15435 PP, 15435 RD and 15435 AMB Posies	The kit allows for the creation of an interesting garden centerpiece that replicates nature with Posies that can be installed at an angle at varying heights. Can also be used to install three fixtures at the same height. Colors may be mixed or uniform. Kit included a mounting plate, 14" In-ground stake for added stability, a 3" Olde Bronze® stem section and the necessary hardware and instructions to make a truly creative garden feature.
LENS/SHIELD ACCESSORIES		ITEM NUMBER	NOTES
LED Amber Lens 	 POWERED BY DESIGN PRO LED TECHNOLOGY WITH Radiax OPTICS	16064 AMB for use with 3W & 4W – 16000, 16001, 16002, 16003, 16004, 16005	Designed specifically for Kichler Design Pro LED with Radiax Optics, lens offers the ability to create a warmer lighting effect.
		16065 AMB for use with 6.5W & 13W – 16006, 16007, 16008, 16009, 16010, 16011	
		16066 AMB for use with 21W – 16012, 16013, 16014	
LED Green Lens 	 POWERED BY DESIGN PRO LED TECHNOLOGY WITH Radiax OPTICS	15875 AMB for use with 15731, 15732, 15733, 15741, 15742, 15743, 15767, 15768, 15769, 15728, 15747, 15748	Designed specifically for Kichler Design Pro LED, lens offers the ability to create a warmer lighting effect.
		15876 AMB for use with 15751, 15752, 15753, 15729, 15757, 15758	
		16064 GRN for use with 3W & 4W – 16000, 16001, 16002, 16003, 16004, 16005	
LED Frosted Lens 	 POWERED BY DESIGN PRO LED TECHNOLOGY WITH Radiax OPTICS	16065 GRN for use with 6.5W & 13W – 16006, 16007, 16008, 16009, 16010, 16011	Designed specifically for Kichler Design Pro LED, greens of foliage can be intensified to illustrate their true beauty.
		16066 GRN for use with 21W – 16012, 16013, 16014	
		15885 AMB for use with 15731, 15732, 15733, 15741, 15742, 15743, 15767, 15768, 15769, 15728, 15747, 15748	
LED Frosted Lens 	 POWERED BY DESIGN PRO LED TECHNOLOGY WITH Radiax OPTICS	15886 AMB for use with 15751, 15752, 15753, 15729, 15757, 15758	Designed specifically for Kichler Design Pro LED, creates a soft focus and diffuses the light to provide even, clean illumination
		16064 FRO for use with 3W & 4W – 16000, 16001, 16002, 16003, 16004, 16005	
		16065 FRO for use with 6.5W & 13W – 16006, 16007, 16008, 16009, 16010, 16011	
		16066 FRO for use with 21W – 16012, 16013, 16014	Designed specifically for Kichler Design Pro LED, creates a soft focus and diffuses the light to provide even, clean illumination
	15895 FRO for use with LED fixtures 15731, 15732, 15733, 15741, 15742, 15743, 15767, 15768, 15769, 15728, 15747, 15748		
		15896 FRO for use with LED fixtures 15751, 15752, 15753, 15729, 15757, 15758	

INCANDESCENT / LED 12V ACCESSORIES

LENS/SHIELD ACCESSORIES	ITEM NUMBER	NOTES
<p>Incandescent Frosted Lens</p> 	<p>15672 FRO for use with fixture 15382 15676 FRO for use with fixtures 15092, 15384, 15484, 15494 15691 FRO for use with fixture 15381 15643 FRO for use with fixture 15374 15633 FRO for use with fixture 15398</p>	<p>Creates a soft focus and diffuses the light to provide even, clean illumination</p>
<p>Polycarbonate Lens</p> 	<p>15677 CLR for use with fixture 15827 15695 CLR for use with fixture 15315/15815 15696 CLR for use with fixture 15362</p>	<p>Accessory lens of clear polycarbonate plastic. Provides additional internal protection from lawn sprinklers, etc.</p>
<p>Incandescent Linear Lens</p> 	<p>15674 LIN clear ribbed for use with fixture 15382 15675 LIN clear ribbed for use with fixtures 15092, 15384, 15484, 15494 15692 LIN clear ribbed for use with fixture 15381 15642 LIN clear ribbed for use with fixture 15374 15632 LIN clear ribbed for use with fixture 15398</p>	<p>Create a directional beam to highlight or elongate the beam spread on columns, arches and taller trees</p>
<p>Heat Resistant Lens</p> 	<p>15659 AZT for use with fixture 15079 15689 BK for use with fixtures 15088, 15388</p>	<p>Heat-resistant glass lens held in an aluminum ring</p>
<p>Blue Lens</p> 	<p>15673 BL for use with fixture 15382 15686 BL for use with fixtures 15092, 15384, 15484, 15494 15687 BL for use with fixture 15381 15693 BL for use with fixture 15397 15641 BL for use with fixture 15374 15631 BL for use with fixture 15398</p>	<p>Blue glass filters act as color enhancers to bring out the true rich greens of foliage for incandescent light sources.</p>
<p>LED Long Cowl</p> 	<p>16060 AZT 16060 BBR 16060 BKT for use with 6.5W & 13W fixtures 16006 16060 WHT 16007, 16008, 16009, 16010, 16011 16062 AZT 16062 BBR 16062 BKT for use with 21W fixtures 16012, 16013, 16062 WHT 16014</p>	<p>Ideal solution for downlighting where increased glare control is needed.</p>
<p>LED 360° Short Cowl</p> 	<p>16061 AZT 16061 BBR 16061 BKT for use with 6.5W & 13W fixtures 16006 16061 WHT 16007, 16008, 16009, 16010, 16011 16063 AZT 16063 BBR 16063 BKT for use with 21W fixtures 16012, 16013, 16063 WHT 16014</p>	<p>Full shroud for expanded glare control. Great option for downlighting to recess light source back.</p>

INCANDESCENT / LED 12V ACCESSORIES

LENS/SHIELD ACCESSORIES	ITEM NUMBER	NOTES						
<p>Cowl – Polycarbonate</p>  <p>2.5"</p> <p>POWERED BY DESIGN PRO LED TECHNOLOGY WITH Radiax OPTICS</p>	<p>16050 BBRP for use with 4W, 6.5W & 14W fixtures 16030, 16031, 16032, 16033, 16034, 16035, 16036, 16037, 16038</p>	<p>Feature water weeping channels for drainage. Easy two-screw installation.</p>						
<p>Cowl – Cast Brass</p>  <p>2.5"</p> <p>POWERED BY DESIGN PRO LED TECHNOLOGY WITH Radiax OPTICS</p>	<p>16050 BBR for use with 4W, 6.5W & 14W fixtures 16030, 16031, 16032, 16033, 16034, 16035, 16036, 16037, 16038</p>	<p>Feature water weeping channels for drainage. Easy two-screw installation.</p>						
<p>LED Snap-On Cowls</p>  <p>15703: 5.6" 15704: 6.5"</p> <p>2.6"</p>	<table border="0"> <tr> <td data-bbox="526 531 748 678"> <p>Short Cowl 15701 AZTP, BKTP for use with fixtures 15731, 15732, 15733, 15741, 15742, 15743</p> </td> <td data-bbox="748 531 980 678"> <p>Long Cowl 15703 AZTP, BKTP for use with fixtures 15731, 15732, 15733, 15741, 15742, 15743</p> </td> </tr> <tr> <td data-bbox="526 678 748 783"> <p>15702 AZTP, BKTP for use with fixtures 15751, 15752, 15753</p> </td> <td data-bbox="748 678 980 783"> <p>15704 AZTP, BKTP for use with fixtures 15751, 15752, 15753</p> </td> </tr> <tr> <td data-bbox="526 783 748 846"> <p>For BBR fixture finishes, use AZTP</p> </td> <td data-bbox="748 783 980 846"> <p>For BBR fixture finishes, use AZTP</p> </td> </tr> </table>	<p>Short Cowl 15701 AZTP, BKTP for use with fixtures 15731, 15732, 15733, 15741, 15742, 15743</p>	<p>Long Cowl 15703 AZTP, BKTP for use with fixtures 15731, 15732, 15733, 15741, 15742, 15743</p>	<p>15702 AZTP, BKTP for use with fixtures 15751, 15752, 15753</p>	<p>15704 AZTP, BKTP for use with fixtures 15751, 15752, 15753</p>	<p>For BBR fixture finishes, use AZTP</p>	<p>For BBR fixture finishes, use AZTP</p>	<p>Finishes to match Design Pro LED accent fixtures. Easy one step snap-on installation – glare shield rotates 360° in ring and retains its desired shield position.</p>
<p>Short Cowl 15701 AZTP, BKTP for use with fixtures 15731, 15732, 15733, 15741, 15742, 15743</p>	<p>Long Cowl 15703 AZTP, BKTP for use with fixtures 15731, 15732, 15733, 15741, 15742, 15743</p>							
<p>15702 AZTP, BKTP for use with fixtures 15751, 15752, 15753</p>	<p>15704 AZTP, BKTP for use with fixtures 15751, 15752, 15753</p>							
<p>For BBR fixture finishes, use AZTP</p>	<p>For BBR fixture finishes, use AZTP</p>							
<p>LED Rock Guard – Polycarbonate</p>  <p>POWERED BY DESIGN PRO LED TECHNOLOGY WITH Radiax OPTICS</p>	<p>16051 BBRP for use with 4W, 6.5W & 14W fixtures 16030, 16031, 16032, 16033, 16034, 16035, 16036, 16037, 16038</p>	<p>Feature water weeping channels for drainage. Easy two-screw installation. Walk-over rated.</p>						
<p>LED Rock Guard – Cast Brass</p>  <p>POWERED BY DESIGN PRO LED TECHNOLOGY WITH Radiax OPTICS</p>	<p>16051 BBR for use with 4W, 6.5W & 14W fixtures 16030, 16031, 16032, 16033, 16034, 16035, 16036, 16037, 16038</p>	<p>Drive-over & walk-over rated to 4,500 lbs.</p>						
<p>LED Rock Guard</p>  <p>5.90" D 1.686" H</p>	<p>15787 BK only for use with fixtures 15767BKT, 15768BKT, 15769BKT, 15728BKT, 15747BKT, 15748BKT, 15729BKT, 15757BKT, 15758BKT</p>	<p>Rock Guard/Glare Shield accessory for Design Pro LED Well Light Series. High-strength, UV and corrosion resistant polycarbonate housing. Black Polycarbonate finish.</p>						
<p>Incandescent Rock Guard</p>  <p>6.97" D 1.29" H</p>	<p>15694 AZ for use with fixture 15194 or 15268</p>	<p>Rock Guard/Glare Shield corrosion resistant for use with 15194 or 15268 well light. Architectural Bronze Polycarbonate Finish.</p>						
<p>Incandescent Rock Guard</p>  <p>5.90" D 1.686" H</p>	<p>15690 BK for use with fixtures 15088BK or 15388 BK.</p>	<p>Rock Guard/Glare Shield accessory for 15088BK and 15388BK Well Lights. Polycarbonate housing. High-strength, UV and corrosion resistant polycarbonate housing. Black Polycarbonate finish.</p>						
<p>45° Hexcell Louver</p> 	<p>15679 BK for use with fixtures 15092, 15384, 15484, 15494 15680 BK for use with fixture 15381 15683 BK for use with fixture 15397 15644 BK for use with fixture 15374 15634 BK for use with fixture 15398</p>	<p>Expanded aluminum shield with high temperature black finish. Provides maximum glare reduction for accent lights.</p>						

INCANDESCENT / LED 12V ACCESSORIES

CONNECTION ACCESSORIES		ITEM NUMBER	NOTES
Low Voltage Cable 	For use with all 12V rated fixtures. 12-gauge 10-gauge 15501 BK 100' 15504 BK 250' 15502 BK 250' 15505 BK 500' 8-gauge 15506 BK 1000' 15503 BK 250' For use with all 12V rated fixtures.	#12-2, #10-2, 8-2 conductor SPT cable. UL listed for 12V outdoor lighting applications. UV stabilized PVC insulation. For direct burial.	
Gel Filled Wire Connector 	15579 BK for use when connecting: • 8-gauge wire to 10- and 12-gauge • connecting 10-gauge wire to 12-gauge wire 15589 BK for use when connecting: • 10-gauge wire • 12-gauge wire • 10-gauge wire to 12-gauge wire • 12-gauge wire to 18-gauge wire	Wire connector offers twist-on, waterproof, in-line cable splicing for direct burial. Services both 12V or 120V line voltage.	
QUIC DISC® Connector 	15509 BK for use with #12-2 or #10-2 low voltage cable only	Joins #18-2 fixture leads with #12-2 or #10-2 low voltage cable. Injection molded polycarbonate with nickel plated brass contacts to provide maximum corrosion protection and improved conductivity.	
Pro Series Wire Connector 	15529 BL Bulk pack of 100 connectors packed in sealed bags of 10.	Gel filled wire connector provides watertight long lasting connection. Suitable for direct burial. Connects two #12 gauge to one #18 gauge. Two connectors required per connection.	
TRANSFORMER ACCESSORIES		ITEM NUMBER	NOTES
Mechanical Transformer Timer 3" W 3.09" H 2.75" L 	15557 BK	Plug-in timer suitable for outdoor temperatures when enclosed in an outdoor transformer enclosure. For use in all Plus and Professional series transformers.	
Digital Transformer Timer 2.73" W 3.84" H 1.89" L 	15556 WH	Plug-in digital timer is for use with all Plus and Professional series transformers Battery backup included. Straight forward programming and easy day light savings change over.	
Remote Plug-In Transformer Photocell 	15534 BK	Plug-In Photocell with 10' cord is for use with all Plus and Professional Series Transformers	
Plug-In Transformer Photocell 	15565 BK	Plug-In Photocell is for use with all Plus and Professional Series Transformers	
Synchronizer Device 	15511 BK	Synchronize all transformers used in a landscape setting so they turn on and off at the same time. Jumper wire (not included) should be a minimum of 24 gauge.	
INSTALLATION ACCESSORIES		ITEM NUMBER	NOTES
Kichler Landscape Flag Marker 	15507 ONG	A great tool to use for designing your landscape lighting system. Plot out your landscape lighting needs with these green marker flags.	
Corrosion Preventative Compound 	15670 BK	Specially formulated non-conductive sealant and corrosion preventative for all types of electrical contacts. Its grease-like consistency helps prevent intrusion of dust, moisture and rust. Apply to socket shell and bulb base. Acts to increase bulb and socket life. 2 oz. tube.	

LED 12V Lamps

Landscape LED lamps developed the Kichler way.





Proven LED performance, superior savings and a broad range of options for landscape lighting systems

We've taken everything we know about LED technology and created a new line of lamps that help save money without sacrificing performance. Designed to fit landscape, outdoor, and security lighting fixtures for both 12v and 120v-277v systems. Kichler® LED lamps offer superior cost savings in terms of energy used and total cost of ownership. You'll also find an exceptional variety of lamp options so you can create the lighting look you want. And, because they're from Kichler, you are assured that the lamps will perform and last.

PROVEN PERFORMANCE

All Kichler LED lamps are designed, tested and listed for use in outdoor environments and are suitable for use in **outdoor wet locations**, and in open or **enclosed** fixtures.

Weather coated and **epoxy potted** electronics match the end-use application, assuring **superior durability** for all-weather performance.



MR16 Bi-Pin



PAR20 WET



CAST ALUMINUM HEAT SINK, ANODIZED BLACK, FOR ENHANCED THERMAL MANAGEMENT

EPOXY POTTING PROTECTS & SEALS CRITICAL COMPONENTS

PAR36 AR111 shown Rated IP 66

All lamps are listed or certified by UL, ETL, and/or CSA to the appropriate ANSI/standard for both the United States and Canada and have been tested for FCC compliance, assuring they won't interfere with other home electronic devices. So, you don't have to worry about inadvertent interference.



We've given our lamps a warranty to match: **30,000 hours or 6 years** even in an enclosed fixture.





T5 Wedge



PAR36
AR111



PAR30
WET
Longneck

SUPERIOR SAVINGS

Kichler® LED lamps can help to **lower the total operating cost** of your existing system, whether you're replacing halogen or other incandescent lamps. You get all of the light needed, while **consuming less wattage**.

6 YEAR Cost Comparison Based on operating cost for 25 fixture installation

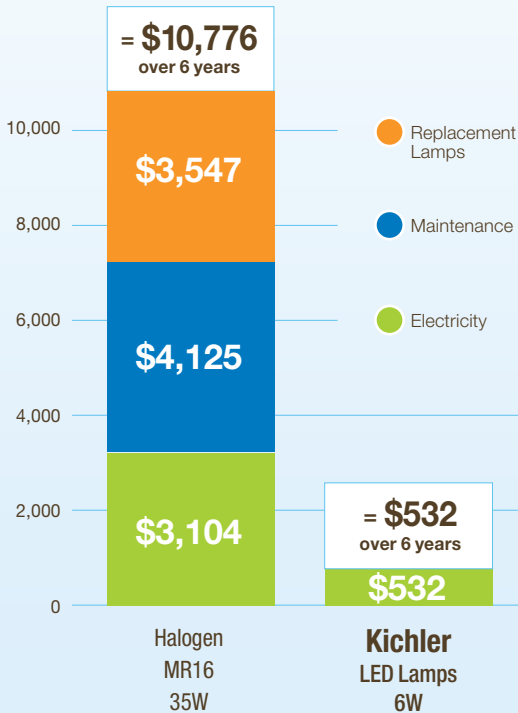

Less Bulb Replacements
+
Less Maintenance
= Longer Service Life*

1 LED
MR16
Bi-Pin



OUTLASTS

13 MR16
Incandescent
Bulbs



* Over 6 years

They not only use less energy, but also last longer than traditional bulbs, meaning **less maintenance** and **no bulbs to replace**. In fact, testing confirms that the lamps will **pay for themselves** in less than two years.

BROAD RANGE OF OPTIONS

When you choose Kichler® LED lamps you don't have to worry about the **voltage, beam spread** or **lamp type** your system requires – because **we've got it all**. With many (light output) **lumen options**, you can get the **exact light output you need**. And, they are **compatible with** all of our **hybrid fixtures**.



Kelvin Temperature Range

Plus, our range of Kelvin **color temperature choices** helps you **customize** the color of the light to **your application**.



Warm White
2700K

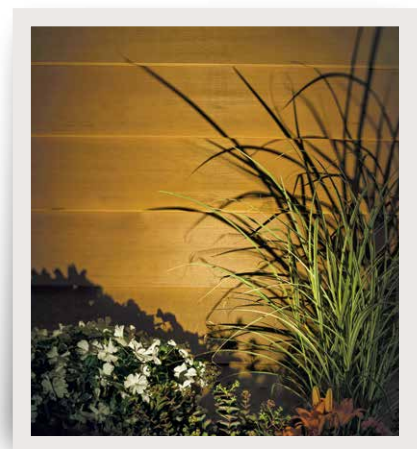

Pure White
3000K



Cool White
4200K

Beam Spread Options

We also offer lamps for a variety of **fixture types** and **beam spread choices** from **narrow spot** to **wide flood**. Beam spread options vary between 12V and 120V lamps.

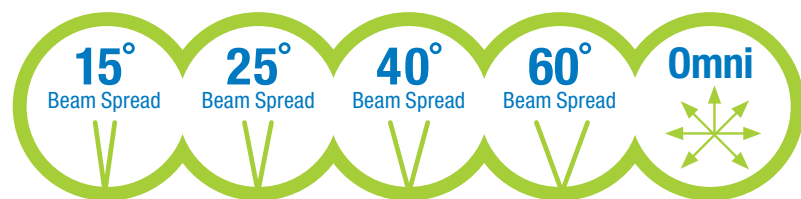



MR16 Bi-Pin



MR16 Bi-Pin



PAR36/
AR11



S8 Wedge



T5 Wedge



G4/T3 Bi-Pin

12v FEATURES

- ★ Potted and/or coated electronics protect against moisture
- ★ Generates consistent light output for systems with an operating range from 9V to 15V with no loss in light output because of constant current driver designs
- ★ Designed and listed for outdoor use in enclosed fixtures or wet locations
- ★ Cast aluminum heat sink, anodized black, for increased thermal management
- ★ Integrated, high output Cree®* LEDs tightly binned for high CRI, color uniformity and color quality
- ★ 30,000 hour life in an enclosed fixture
- ★ FCC compliance ensures no interference with other electronic devices
- ★ High total lumens and lumens per watt (efficacy)
- ★ Custom optics deliver center-to-edge beam uniformity

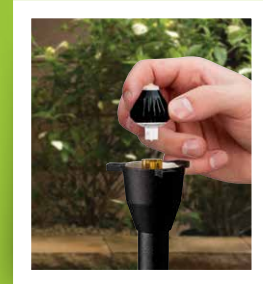

12v PHOTOMETRICS

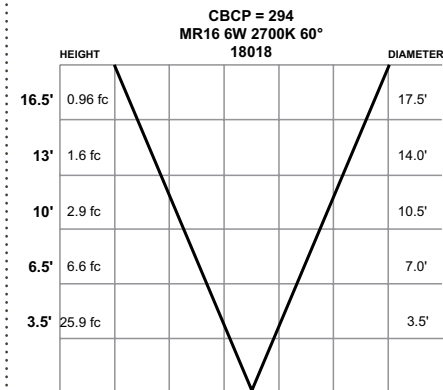
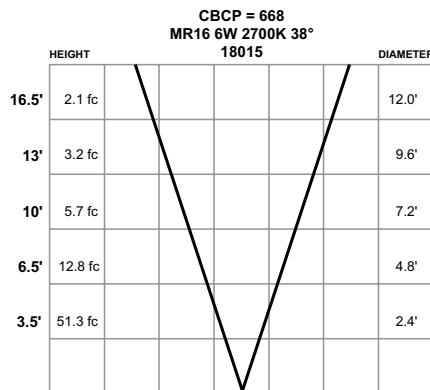
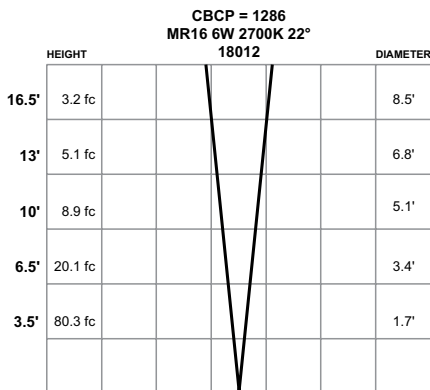
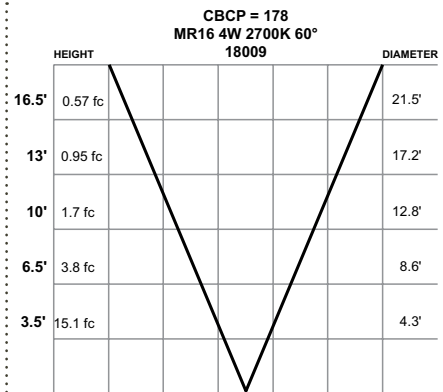
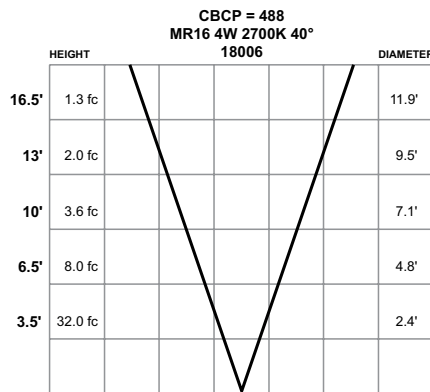
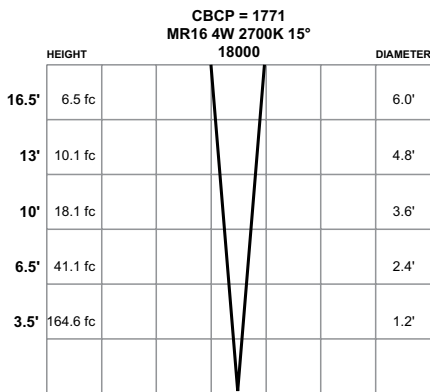

* The curves indicate the illuminated area and the average illumination when the luminaire is at different distances. Stated footcandles are for bare lamps only. For additional photometrics, visit landscapelighting.com

12V LED LAMPS

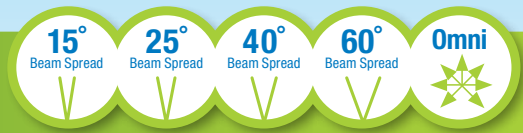

Base / Lamp Type	Watts	Kelvin / Lumens	Beam Angle			
MR16 Bi-Pin Medium Power 	4W, 5.2VA* Compares up to 20-25W Halogen		15° Spot	25° Wide Spot	40° Flood	60° Wide Flood
		2700K - Warm White 240Lm	18000	18003	18006	18009
		3000K - Pure White 260Lm	18001	18004	18007	18010
		4200K - Cool White 280Lm	18002	18005	18008	18011
MR16 Bi-Pin High Power 	6W, 9VA* Compares up to 35-40W Halogen		22° Spot	38° Flood	60° Wide Flood	
		2700K - Warm White 350Lm	18012	18015	18018	
		3000K - Pure White 380Lm	18013	18016	18019	
		4200K - Cool White 410Lm	18014	18017	18020	
PAR36/AR111 Wet Location 	11W, 14.9VA* Compares up to 50W Halogen		15° Spot	25° Wide Spot	40° Flood	
		2700K - Warm White 540Lm	18021	18024	18027	
		3000K - Pure White 600Lm	18022	18025	18028	
		4200K - Cool White 660Lm	18023	18026	18029	
S8 Wedge 	2W, 2.8VA* Compares up to 18.5W Krypton		300° Omni-directional			
		2700K - Warm White 85Lm	18036			
		3000K - Pure White 100Lm	18037			
		4200K - Cool White 110Lm	18038			
T5 Wedge 	2W, 2.8VA* Compares up to 16W Xenon		300° Omni-directional			
		2700K - Warm White 85Lm	18039			
		3000K - Pure White 100Lm	18040			
		4200K - Cool White 110Lm	18041			
G4/T3 Bi-Pin 	2W, 2.8VA* Compares up to 20W Halogen		300° Omni-directional			
		2700K - Warm White 85Lm	18042			
		3000K - Pure White 100Lm	18043			
		4200K - Cool White 110Lm	18044			

* Multiply fixture VA by the number of fixtures used to determine size of transformer.

Stated lumens are for bare lamp only. Using lamp in enclosed fixtures can result in up to 30-50% loss in lumen output based on test data.









All lamps are listed or certified by UL, ETL, and/or CSA to the appropriate ANSI/standard for both the United States and Canada and have tested for FCC compliance, assuring they won't interfere with other home electronic devices. So, you don't have to worry about inadvertent interference.



Incandescent 12V Lamps



INCANDESCENT 12V LAMPS

	Product ID	12V Bulb Type	Wattage	Beam Spread	Base	Average Life
	15599 CLR	3155K Krypton	18.5		Wedge	5,700
	15598 CLR	3156K Krypton	24.4		Wedge	5,000
	17011	Q10T3 Halogen	10		Bi-Pin	10,000
	17012	Q20T3 Halogen	20		Bi-Pin	5,000
	17013	Q35T3 Halogen	35		Bi-Pin	2,000
	17015	Q50T4 Halogen	50		Bi-Pin	2,000
	17017	Q75T4 Halogen	75		Bi-Pin	2,000
	17021	901X Xenon	4		Wedge	19,000
	17022	918X Xenon	6.5		Wedge	8,000
	17023	912X Xenon	11.6		Wedge	10,000
	17025	921X Xenon	16.25		Wedge	10,000
	17030	PAR-36 Halogen	20	Narrow Spot 8°	Screw Terminal	4,000
	17032	PAR-36 Halogen	20	Narrow Flood 20°	Screw Terminal	4,000
	17033	PAR-36 Halogen	20	Flood 30°	Screw Terminal	4,000
	17037	PAR-36 Halogen	35	Narrow Spot 8°	Screw Terminal	4,000
	17039	PAR-36 Halogen	35	Narrow Flood 20°	Screw Terminal	4,000
	17040	PAR-36 Halogen	35	Flood 30°	Screw Terminal	4,000
	17044	PAR-36 Halogen	50	Narrow Spot 8°	Screw Terminal	4,000
	17046	PAR-36 Halogen	50	Narrow Flood 20°	Screw Terminal	4,000
	17047	PAR-36 Halogen	50	Flood 30°	Screw Terminal	4,000
	17050	MR-11 Halogen	20	Narrow Spot 10°	Bi-Pin	2,000
	17051	MR-11 Halogen	20	Spot 17°	Bi-Pin	2,000
	17052	MR-11 Halogen	20	Flood 30°	Bi-Pin	2,000
	17055	MR-11 Halogen	35	Narrow Spot 12°	Bi-Pin	2,000
	17056	MR-11 Halogen	35	Spot 20°	Bi-Pin	2,000
	17057	MR-11 Halogen	35	Flood 30°	Bi-Pin	2,000
	17060	MR-16 Halogen	20	Narrow Spot 12°	Bi-Pin	5,000
	17061	MR-16 Halogen	20	Spot 24°	Bi-Pin	5,000
	17062	MR-16 Halogen	20	Flood 36°	Bi-Pin	5,000
	17063	MR-16 Halogen	20	Wide Flood 60°	Bi-Pin	5,000
	17070	MR-16 Halogen	35	Narrow Spot 12°	Bi-Pin	5,000
	17071	MR-16 Halogen	35	Spot 24°	Bi-Pin	5,000
	17072	MR-16 Halogen	35	Flood 36°	Bi-Pin	5,000
	17073	MR-16 Halogen	35	Wide Flood 60°	Bi-Pin	5,000
	17080	MR-16 Halogen	50	Narrow Spot 12°	Bi-Pin	5,000
	17081	MR-16 Halogen	50	Spot 24°	Bi-Pin	5,000
	17082	MR-16 Halogen	50	Flood 36°	Bi-Pin	5,000
	17083	MR-16 Halogen	50	Wide Flood 60°	Bi-Pin	5,000
	17090	MR-16 Halogen	75	Narrow Spot 12°	Bi-Pin	5,000
	17091	MR-16 Halogen	75	Spot 24°	Bi-Pin	5,000
17092	MR-16 Halogen	75	Flood 36°	Bi-Pin	5,000	
17093	MR-16 Halogen	75	Wide Flood 60°	Bi-Pin	5,000	
	17066	MR-16 Halogen	20	Spot 24°	Bi-Pin	10,000
	17067	MR-16 Halogen	20	Flood 36°	Bi-Pin	10,000
	17076	MR-16 Halogen	35	Spot 24°	Bi-Pin	10,000
	17077	MR-16 Halogen	35	Flood 36°	Bi-Pin	10,000
	17078	MR-16 Halogen	35	Wide Flood 60°	Bi-Pin	10,000
	17085	MR-16 Halogen	50	Narrow Spot 12°	Bi-Pin	10,000
	17086	MR-16 Halogen	50	Spot 24°	Bi-Pin	10,000
	17087	MR-16 Halogen	50	Flood 36°	Bi-Pin	10,000
	17088	MR-16 Halogen	50	Wide Flood 60°	Bi-Pin	10,000
	15572 FRO	A-19 12-V	25		Medium	





KICHLER®



LED / Incandescent 120V / HID

Create a total landscape plan, with a variety of commercial-grade pieces that live up to harsh environmental conditions and every-day wear-and-tear.

Illuminating a commercial setting means planning for the here-and-now – and for the future. Our Design Pro LED accent lights, featuring our exclusive Radiax™ Optics deliver the greatest lumens per watt in the industry for energy savings and lower maintenance costs for comparable fixtures.

Our powerful halogen and HID fixtures are built to last with durable, cast-aluminum housings for years of reliable performance at a value.



FEATURES

- Three lumen output options for just the right punch of light.
- Three beam spread options, 10°, 35° or 60°, put light where you want it.
- A range of Kelvin color temperature choices from pure white 3000K to cool white 4250K.
- Radiax™ Optics deliver the greatest lumens per watt in the industry for comparable fixtures.
- Constructed from durable, specification grade materials.

LED 120V Accent

In the commercial world, ROI counts – and you can count on our 120V fixtures to pay for themselves on average in less than two years with lower cost of ownership. Plus, our Radiax Optics deliver more efficient lumens per watt, for energy savings that help the bottom line. There's no better solution for replacing your halogen PAR and metal halide lamps.

75W Halogen

= \$113.73
per year

19.5W Design Pro LED

= \$11.53
per year

Superior Light Fixtures, Superior Results



Design Pro LED fixture
120V, 12.5 Watt



Competitor LED Fixture
120V, 13 Watt

DESIGN PRO LED 120V ACCENT



16200, 16201, 16206 - 120V 12.5W LED ACCENT

Description	A specification-grade LED fixture collection for both new installations and existing fixture replacement.
Ordering Guide & Finish	Textured Architectural Bronze (marine grade powder coat) Bronzed Brass Textured White (marine grade powder coat)
Housing	Cast Aluminum, Cast Brass (brass will naturally patina over time)
Light Source	5 Integrated High Output Cree® LEDs, tightly binned for color uniformity
Color Temp. (CCT) & CRI	3000K (-45/+130) Pure White, 4250K (-250/+250) Cool White 3000K = 80s, 4250K = 85 minimum
Optics	Radiax™
Power Usage	12.5W, .13VA, .85pf
Operating Voltage Range	108-132V AC, 50-60 Hz with no loss in output due to constant current technology
Lumen Maint.	Tested to an L-70 of 40,000 hours
Total Lumens & Efficacy	3000K = 590 Lm 4250K = 646 Lm 3000K = 47 Lm/W 4250K = 52 Lm/W
Wiring	8" of usable 200° C 18AWG wire leads
Mounting Acces.	N/A
Optional Acces.	15276 - Power Post® 15601 - Surface Mounting Flange, for attachment to junction box 15609 - Junction Box Mounting Bracket
Notes	Subjected to Highly Accelerated Life Testing – 3rd party reliability testing *Cree is a registered trademark of Cree, Inc.

ORDER GUIDE



Kelvin	3000K PURE WHITE	4250K COOL WHITE
Watts/Lumens	Compares to Halogen 50W PAR30	
Beam Spread 10° Spot	16200 AZT30 16200 BBR30 16200 WHT30	16200 AZT42 16200 BBR42 16200 WHT42
Beam Spread 35° Flood	16201 AZT30 16201 BBR30 16201 WHT30	16201 AZT42 16201 BBR42 16201 WHT42
Beam Spread 60° Wide Flood	16206 AZT30 16206 BBR30 16206 WHT30	16206 AZT42 16206 BBR42 16206 WHT42

FINISH GUIDE

- AZT – Textured Architectural Bronze
- BBR – Bronzed Brass
- WHT – Textured White

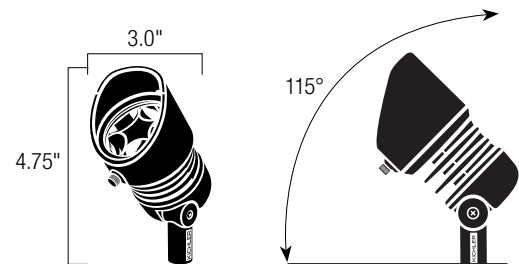

DESIGN PRO LED 120V ACCENT



16202, 16203, 16207 - 120V 19.5W LED ACCENT

Description	A specification-grade LED fixture collection for both new installations and existing fixture replacement.
Ordering Guide & Finish	Textured Architectural Bronze (marine grade powder coat) Bronzed Brass, Textured White (marine grade powder coat)
Housing	Cast Aluminum, Cast Brass (brass will naturally patina over time)
Light Source	8 Integrated High Output Cree® LEDs, tightly binned for color uniformity
Color Temp. (CCT) & CRI	3000K (-45/+130) Pure White, 4250K (-250/+250) Cool White 3000K = 80s, 4250K = 85 minimum
Optics	Radiax™
Power Usage	19.5W, .18A, .90pf
Operating Voltage Range	108-132V AC, 50-60 Hz with no loss in output due to constant current technology
Lumen Maint.	Tested to an L-70 of 40,000 hours
Total Lumens & Efficacy	3000K = 947 Lm 4250K = 993 Lm 3000K = 49 Lm/W 4250K = 51 Lm/W
Wiring	8" of usable 200° C 18AWG wire leads
Mounting Acces.	N/A
Optional Acces.	15276 - Power Post® 15601 - Surface Mounting Flange, for attachment to junction box 15609 - Junction Box Mounting Bracket
Notes	Subjected to Highly Accelerated Life Testing – 3rd party reliability testing *Cree is a registered trademark of Cree, Inc.

ORDER GUIDE



Kelvin	3000K PURE WHITE	4250K COOL WHITE
Watts/Lumens	Compares to Halogen 75W PAR30	
Beam Spread 10° Spot	16202 AZT30 16202 BBR30 16202 WHT30	16202 AZT42 16202 BBR42 16202 WHT42
Beam Spread 35° Flood	16203 AZT30 16203 BBR30 16203 WHT30	16203 AZT42 16203 BBR42 16203 WHT42
Beam Spread 60° Wide Flood	16207 AZT30 16207 BBR30 16207 WHT30	16207 AZT42 16207 BBR42 16207 WHT42

FINISH GUIDE

AZT – Textured Architectural Bronze
BBR – Bronzed Brass
WHT – Textured White

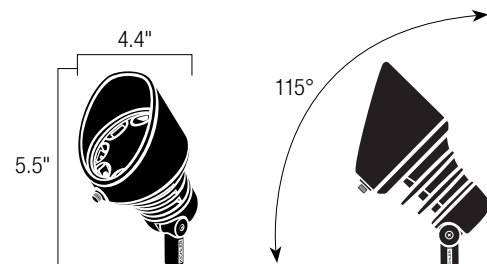

DESIGN PRO LED 120V ACCENT



16204, 16205, 16208 - 120V 29W LED ACCENT

Description	A specification-grade LED fixture collection for both new installations and existing fixture replacement.
Ordering Guide & Finish	Textured Architectural Bronze (marine grade powder coat) Bronzed Brass Textured White (marine grade powder coat)
Housing	Cast Aluminum, Cast Brass (brass will naturally patina over time)
Light Source	8 Integrated High Output Cree® LEDs, tightly binned for color uniformity
Color Temp. (CCT) & CRI	3000K (-45/+130) Pure White, 4250K (-250/+250) Cool White 3000K = 80s, 4250K = 85 minimum
Optics	Radiax™
Power Usage	29W, .27A, .90pf
Operating Voltage Range	108-132V AC, 50-60 Hz with no loss in output due to constant current technology
Lumen Maint.	Tested to an L-70 of 40,000 hours
Total Lumens & Efficacy	3000K = 1,131 Lm 4250K = 1,368 Lm 3000K = 39 Lm/W 4250K = 47 Lm/W
Wiring	8" of usable 200° C 18AWG wire leads
Mounting Acces.	N/A
Optional Acces.	15276 - Power Post® 15601 - Surface Mounting Flange, for attachment to junction box 15609 - Junction Box Mounting Bracket
Notes	Subjected to Highly Accelerated Life Testing – 3rd party reliability testing *Cree is a registered trademark of Cree, Inc.

ORDER GUIDE



Kelvin	3000K PURE WHITE	4250K COOL WHITE
Watts/Lumens	Compares to Halogen 100W PAR38	
Beam Spread 10° Spot	16204 AZT30 16204 BBR30 16204 WHT30	16204 AZT42 16204 BBR42 16204 WHT42
Beam Spread 35° Flood	16205 AZT30 16205 BBR30 16205 WHT30	16205 AZT42 16205 BBR42 16205 WHT42
Beam Spread 60° Wide Flood	16208 AZT30 16208 BBR30 16208 WHT30	16208 AZT42 16208 BBR42 16208 WHT42

FINISH GUIDE

- AZT – Textured Architectural Bronze
- BBR – Bronzed Brass
- WHT – Textured White

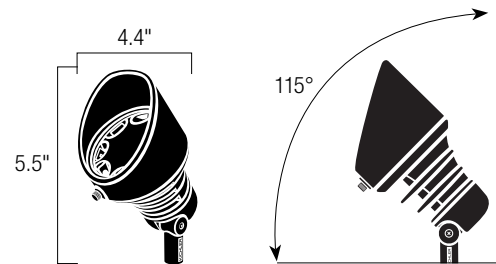

Incandescent / LED 120V / HID Hybrid Accent

Versatile lamping options and optional accessories give you the flexibility you need to meet a variety of client demands.



INCANDESCENT / LED 120V / HID HYBRID ACCENT



15231 AZT, BKT - 120V ACCENT – SMALL 15241 AZT, BKT- 120V ACCENT – MEDIUM 15251 AZT, BKT- 120V ACCENT – LARGE

Description	Small (4") accent light for cross-lighting, spotlighting or grazing	Medium-sized (5") accent light for cross-lighting, accenting or grazing	Large (7") accent light for wider light spread along walls, shrubs, trees
Ordering Guide & Finish	15231 AZT - Textured Architectural Bronze 15231 BKT - Textured Black	15241 AZT - Textured Architectural Bronze 15241 BKT - Textured Black	15251 AZT - Textured Architectural Bronze 15251 BKT - Textured Black
Housing	Cast Aluminum. Tempered convex glass lens.	Cast Aluminum. Tempered convex glass lens.	Cast Aluminum. Tempered convex glass lens.
Wiring	8" of usable 200°C 18 AWG wire leads	8" of usable 200°C 18 AWG wire leads	8" of usable 200°C 18 AWG wire leads
Lamp Base	4000V (4KV) pulse rated medium base porcelain socket	4000V (4KV) pulse rated medium base porcelain socket	4000V (4KV) pulse rated medium base porcelain socket
Supplied Lamp	Lamp not supplied unless noted	Lamp not supplied unless noted	Lamp not supplied unless noted
Incandescent Lamp Options	35-W Max. PAR20 Metal Halide or 50-W Max. PAR20/R20 Incandescent	70-W Max. PAR30L Metal Halide or 75-W(VA) PAR30L/R30 Incandescent	175-W Max. PAR38 Metal Halide, 100-W Max. E17 Metal Halide or 150-W Max. PAR38/R40 Incandescent Reflector: for use with E17 lamp. Removable for PAR38/R40 use.
LED Lamp Options	7W PAR20 Standard (18045-18056) see page 192 Compares up to 35W Halogen Standard version must be used in enclosed fixtures 7W PAR20 Wet (18081-18086) see page 192 Compares up to 35W Halogen	12W PAR30L Standard (18099-18110) see page 192 Compares up to 50W Halogen Standard version must be used in enclosed fixtures 12W PAR30L Wet (18111-18116) see page 192 Compares up to 50W Halogen	17W PAR38 Standard (18069-18080) see page 192 Compares up to 75W Halogen Standard version must be used in enclosed fixtures 17W PAR38 Wet (18093-18098) see page 192 Compares up to 75W Halogen
Optional Mounting Accessories	15276 - Power Post® 15601 - Surface Mounting Flange, for attachment to junction box (not included) 15609 - Junction Box Mounting Bracket	15276 - Power Post® 15601 - Surface Mounting Flange, for attachment to junction box (not included) 15609 - Junction Box Mounting Bracket	15276 - Power Post® 15601 - Surface Mounting Flange, for attachment to junction box (not included) 15609 - Junction Box Mounting Bracket
Optional Lens Accessories	15620 - Medium Cowl 15628 - Long Cowl 15623 - Blue Filter 15637 - Hexcell Louver	15640 - Medium Cowl 15648 - Long Cowl 15624 - Blue Filter 15638 - Hexcell Louver	15660 - Medium Cowl 15668 - Long Cowl 15625 - Blue Filter 15639 - Hexcell Louver
Notes	Accents require remote ballasts for High Intensity Discharge. See HID Ballast Guide on page 185 and 120V Lamp Guide on page 195. For Lamp Photometrics see page 196.	Accents require remote ballasts for High Intensity Discharge. See HID Ballast Guide on page 185 and 120V Lamp Guide on page 195. For Lamp Photometrics see page 196.	Accents require remote ballasts for High Intensity Discharge. See HID Ballast Guide on page 185 and 120V Lamp Guide on page 195. For Lamp Photometrics see page 196.

Denotes fixture is compatible with incandescent or LED lamps.



INCANDESCENT / LED 120V / HID HYBRID ACCENT



15230 AZT - 120V ACCENT – SMALL COMPACT

15250 AZT - 120V ACCENT – LARGE COMPACT

15255 AZT, BKT - 120V DOWNLIGHT

Description	Adjustable, compact accent light (3¾" diameter) for up or downlighting	Adjustable accent light in a larger size (5" diameter) for up or downlighting	Downlight or below horizontal effects with wide light spread. Available as surface or tree-mounted. Designed for below horizontal aiming only.
Ordering Guide & Finish	15230 AZT - Textured Architectural Bronze	15250 AZT - Textured Architectural Bronze	15255 AZT - Textured Architectural Bronze 15255 BKT - Textured Black
Housing	Textured Architectural Bronze (Marine grade powder coat)	Textured Architectural Bronze (Marine grade powder coat)	Textured Architectural Bronze (Marine grade powder coat) Textured Black (Marine grade powder coat)
Wiring	8" of usable 200°C 18 AWG wire leads	8" of usable 200°C 18 AWG wire leads	8" of usable 200°C 18 AWG wire leads
Lamp Base	4000V (4KV) pulse rated medium base porcelain socket	4000V (4KV) pulse rated medium base porcelain socket 	4000V (4KV) pulse rated medium base porcelain socket 
Supplied Lamp	Lamp not supplied unless noted	Lamp not supplied unless noted	Lamp not supplied unless noted
Incandescent Lamp Options	35-W Max. PAR20 Metal Halide or 50-W Max. PAR20 Incandescent	100-W Max. PAR38 Metal Halide or 100-W Max. PAR38 Incandescent	175-W Max. PAR38 Metal Halide, 100-W Max. E17 Metal Halide or 150-W Max. PAR38/R40 Incandescent Reflector: for use with E17 lamp. Removable for PAR38/R40 use.
LED Lamp Options	N/A	12W PAR30L Standard (18099-18110) see page 192 Compares up to 75W Halogen Standard version must be used in enclosed fixtures 12W PAR30L Wet (18111-18116) see page 192 Compares up to 75W Halogen	17W PAR38 Standard (18069-18080) see page 192 Compares up to 75W Halogen Standard version must be used in enclosed fixtures 17W PAR38 Wet (18093-18098) see page 192 Compares up to 75W Halogen
Optional Mounting Accessories	15276 - Power Post® 15601 - Surface Mounting Flange, for attachment to junction box (not included) 15609 - Junction Box Mounting Bracket	15276 - Power Post® 15601 - Surface Mounting Flange, for attachment to junction box (not included) 15609 - Junction Box Mounting Bracket	15601 - Surface Mounting Flange, for attachment to junction box (not included) 15609 - Junction Box Mounting Bracket
Optional Lens Accessories	15630 - Cowl with glass lens	15650 - Cowl with glass lens	15660 - Medium Cowl 15668 - Long Cowl
Notes	Accents require remote ballasts for High Intensity Discharge. See HID Ballast Guide on page 185 and 120V Lamp Guide on page 195. For Lamp Photometrics see page 196.	Accents require remote ballasts for High Intensity Discharge. See HID Ballast Guide on page 185 and 120V Lamp Guide on page 195. For Lamp Photometrics see page 196.	Accents require remote ballasts for High Intensity Discharge. See HID Ballast Guide on page 185 and 120V Lamp Guide on page 195. For Lamp Photometrics see page 196.



 Denotes fixture is compatible with incandescent or LED lamps.

INCANDESCENT / LED 120V / HID HYBRID ACCENT



15295 AZ -IN-GROUND INCANDESCENT – PAR38

15268 AZ - SMALL IN-GROUND – PAR20/PAR30

Description	Incandescent in-ground light. Adjustable to 15° angle. Use with blue filter 15626 to intensify green color in the landscape.	Smaller 7" diameter in-ground light designed for use with PAR20 and PAR30 lamps.
Ordering Guide & Finish	15295 AZ – Architectural Bronze™	15268 AZ – Architectural Bronze™
Housing	Durable thermoplastic composite resin. Tempered convex glass lens fully sealed for watertight outdoor use.	Durable thermoplastic composite resin. Tempered convex glass lens fully sealed for watertight outdoor use.
Wiring	Architectural Bronze™	Architectural Bronze™
Lamp Base	4000V (4KV) pulse rated medium base porcelain socket. Re-enterable encapsulant 	Medium base porcelain socket 
Supplied Lamp	Lamp not supplied unless noted	Lamp not supplied unless noted
Incandescent Lamp Options	150-W Max. PAR38 Incandescent	75-W Max. PAR20 or PAR30 and PAR30 Longneck Incandescent
LED Lamp Options	17W PAR38 Standard (18069-18080) see page 192 Compares up to 75W Halogen Standard version must be used in enclosed fixtures 17W PAR38 Wet (18093-18098) see page 192 Compares up to 75W Halogen	7W PAR20 Standard (18045-18056) see page 192. Compares up to 35W Halogen. Standard version must be used in enclosed fixtures. 7W PAR20 Wet (18081-18086) see page 192. Compares up to 35W Halogen. 12W PAR30 Standard (18057-18068) see page 192. Compares up to 50W Halogen. Standard version must be used in enclosed fixtures. 12W PAR30 Wet (18087-18029) see page 192. Compares up to 50W Halogen. Standard version must be used in enclosed fixtures. 12W PAR30L Standard (18099-18110) see page 192. Compares up to 50W Halogen. Standard version must be used in enclosed fixtures. 12W PAR30L Wet (18111-18116) see page 192. Compares up to 50W Halogen.
Aiming	With adjustable aim assembly, 15° angle, 358° rotation with wing-nut locking mechanism	With adjustable aim assembly, 25° angle, 358° rotation
Optional Accessories	15608 – Concrete Pour Kit (Drive-over) 15616 WH10 – Gel Encapsulant 10 pack	NA
Optional Lens Accessories	15626 – Blue Filter with gasket 15688 – Rock Guard	15694 – Rock Guard
Notes	Drive over capacity 3,000 lbs.	U.S. Patent No. 5,230,559 Korea Patent No. 126459

INCANDESCENT / LED 120V / HID HYBRID ACCENT

A

 Denotes fixture is compatible with incandescent or LED lamps.

INCANDESCENT / LED 120V / HID HYBRID ACCENT



15262 AZ - IN-GROUND 35-W MH

15263 AZ - IN-GROUND 70-W MH

Description	35-W metal halide in-ground light. Adjustable to 15° angle. Use with blue filter 15626 to intensify green color in the landscape.	70-W metal halide in-ground light. Adjustable to 15° angle. Use with blue filter 15626 to intensify green color in the landscape.
Ordering Guide & Finish	15262 AZ - Architectural Bronze™	15263 AZ - Architectural Bronze™
Housing	Durable thermoplastic composite resin. Tempered convex glass lens fully sealed for watertight outdoor use.	Durable thermoplastic composite resin. Tempered convex glass lens fully sealed for watertight outdoor use.
Wiring	4000V (4KV) pulse rated medium base porcelain socket	4000V (4KV) pulse rated medium base porcelain socket
Lamp Base	Internal ANSI M130 Metal Halide ballast included with 120V tap	Internal ANSI M98 Metal Halide ballast with 120V tap
Supplied Lamp	Lamp not supplied unless noted	Lamp not supplied unless noted
Incandescent Lamp Options	35-W PAR20 Metal Halide	70-W PAR30 Metal Halide or 70-W E17 Metal Halide
LED Lamp Options	N/A	N/A
Aiming	With adjustable aim assembly, 15° angle, 358° rotation with wing-nut locking mechanism	With adjustable aim assembly, 15° angle, 358° rotation with wing nut locking mechanism
Optional Accessories	15608 - Concrete Pour Kit (Drive-over) 15616 WH10 - Gel Encapsulant 10 pack	15608 - Concrete Pour Kit (Drive-over) 15616 WH10 - Gel Encapsulant 10 pack
Optional Lens Accessories	15626 - Blue Filter with gasket 15688 - Rock Guard	15626 - Blue Filter with gasket 15688 - Rock Guard
Notes	Drive Over Capacity: 3000 lbs.	Drive Over Capacity: 3000 lbs.



15266 AZ - IN-GROUND 70-W MH QUAD-TAP

Description	70-W metal halide in-ground light with quad taps. Adjustable to 15° angle. Use with blue filter 15626 to intensify green color in the landscape.
Ordering Guide & Finish	15266 AZ - Architectural Bronze™
Housing	Durable thermoplastic composite resin. Tempered convex glass lens fully sealed for watertight outdoor use.
Wiring	4000V (4KV) pulse rated medium base porcelain socket
Lamp Base	Internal ANSI M98 Metal Halide ballast with 120V, 208V, 240V and 277V taps
Supplied Lamp	Lamp not supplied unless noted
Incandescent Lamp Options	70-W PAR30 Metal Halide or 70-W E17 Metal Halide
LED Lamp Options	N/A
Aiming	With adjustable aim assembly, 15° angle, 358° rotation with wing-nut locking mechanism
Optional Accessories	15608 - Concrete Pour Kit (Drive-over) 15616 WH10 - Gel Encapsulant 10 pack
Optional Lens Accessories	15626 - Blue Filter with gasket 15688 - Rock Guard
Notes	Drive Over Capacity: 3000 lbs.

 Denotes fixture is compatible with incandescent or LED lamps.





KICHLER®

Incandescent 120V / HID Path & Spread

Let powerful light inhabit space around walkways, landscapes, and commercial & retail buildings.



INCANDESCENT 120V / HID PATH & SPREAD

Kichler offers a collection of HID bollards employing the same stylish designs, premium quality materials and product flexibility that you've come to expect from Kichler. You'll discover more than ninety possible product combinations to satisfy any construction or specification criteria – and ordering what you need is as simple as 1 – 2 – 3.

STEP 1

Select your head design and finish. Choose from the signature Kichler® segmented roof design in a small or large size, or the traditional rounded top. Two finishes are available: Textured Architectural Bronze™ or Textured Black. Head and louvers are commercial-grade Cast Aluminum construction.

Housing. Cast Aluminum

Lens. Molded ribbed diffuser of clear heat resistant borosilicate lenses

Finish. Textured Architectural Bronze (AZT) or Textured Black (BKT)

Wiring. 43" of usable 200°C 18 AWG wire leads

Socket. 4000-Volt (4KV) pulse rated medium base porcelain socket

Lamp Type. 50, 70, or 100-W. Max. E17 Metal Halide

Head Design

15215 AZT, 15215 BKT, 15221 AZT, 15221 BKT, 15226 AZT, 15226 BKT

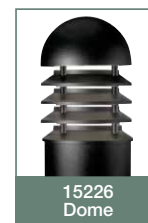

STEP 2

Determine the bollard size, height and diameter.

Bollards are available in 4" or 6" size and in lengths of 18", 24" or 36". Bollard kit is supplied with cast aluminum internal mounting plate including lag bolts for deck or surface mounting. Extruded aluminum bollard finished with baked thermoset powder coat. Order separate bollard template kit for installation into concrete or 15578 BK bollard mounting stake for installation in soil. UL listed.

For use with fixtures 15215, 15221, and 15226.

Finish Textured Architectural Bronze (AZT) or Textured Black (BKT)

Bollard Assembly

15603 AZT 4" x 18"	15603 BKT 4" x 18"	15604 AZT 4" x 24" ,
15604 BKT 4" x 24"	15605 AZT 4" x 36"	15605 BKT 4" x 36"
15613 AZT 6" x 18"	15613 BKT 6" x 18"	15614 AZT 6" x 24"
15614 BKT 6" x 24"	15615 AZT 6" x 36"	15615 BKT 6" x 36"

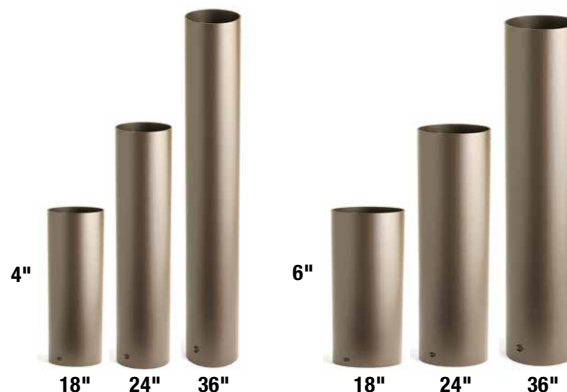

STEP 3

Determine your desired lamp/ballast combination.

50-W, 70-W and 100-W Metal Halide are offered. (Lamps are not included.) Each comes equipped with ballasts that will accept multiple voltage options: 120V, 208V, 240V or 277V. (Because of heat restrictions, 100-W lamplighting cannot be used in the 4" diameter bollard.) All mounting hardware is corrosion resistant.

Ballast Assembly

15BLMH50 BK – 50-W Metal Halide (use with 4" and 6" diameter bollard)

15BLMH70 BK – 70-W Metal Halide (use with 4" and 6" diameter bollard)

15BLMH100 BK – 100-W Metal Halide (use only with 6" diameter bollard)

In addition to the lighting fixtures, Kichler offers 4" and 6" Bollard Template Kits used for permanent installation in concrete. The kits include positioning template, anchor bolts and mounting hardware.

15671 ST – 4" Bollard Template Kit

15678 ST – 6" Bollard Template Kit

Or use optional Bollard Stake **15578**. See page 187.

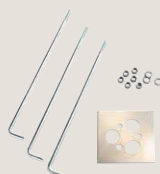

For complete photometrics, please see page 203.

INCANDESCENT 120V / HID PATH & SPREAD

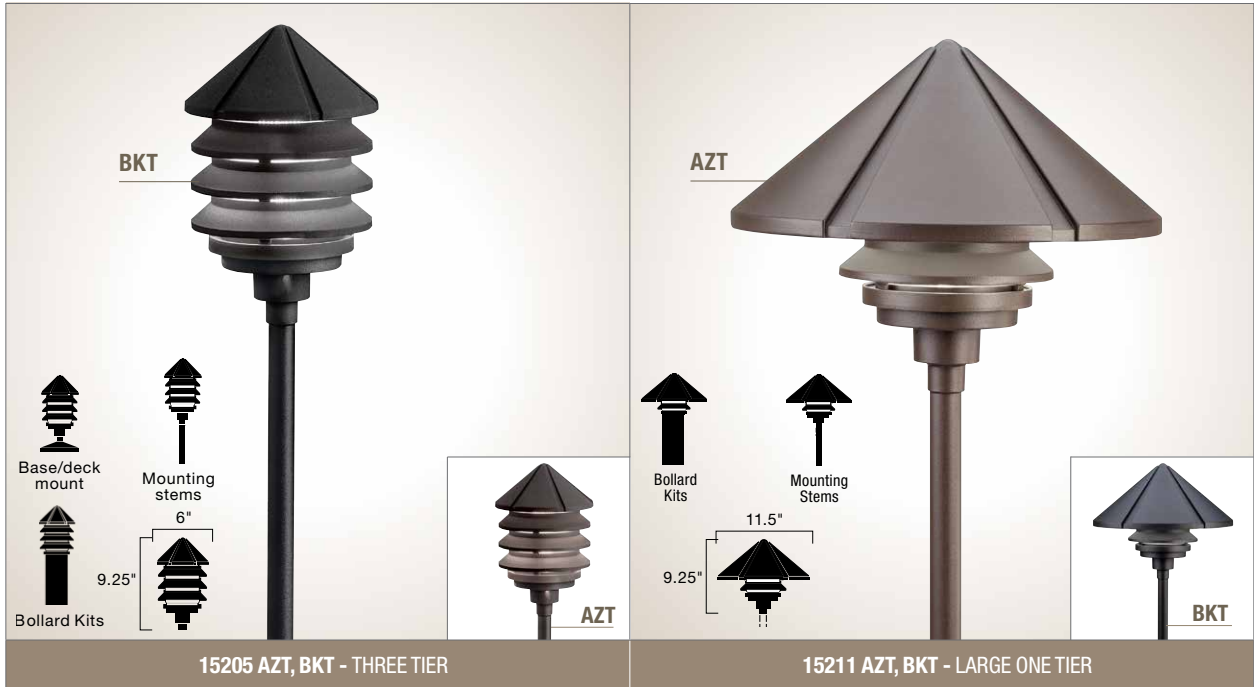

	15205 AZT, BKT - THREE TIER	15211 AZT, BKT - LARGE ONE TIER																																																																																
Description	Versatile, louvered fixture with multiple mounting options for deck or path lighting, on optional post, stem or bollard. Stem or bollard ordered separately	Versatile fixture with wider light distribution for paths and low areas of groundcover. Stem or bollard ordered separately																																																																																
Ordering Guide & Finish	15205 AZT - Textured Architectural Bronze 15205 BKT - Textured Black	15211 AZT - Textured Architectural Bronze 15211 BKT - Textured Black																																																																																
Housing	Cast Aluminum. Molded ribbed diffuser of clear UV stabilized high impact resistant polycarbonate. Mounting stems and bollard kits sold separately	Cast Aluminum. High impact resistant diffuser. Mounting stems and bollard kits sold separately																																																																																
Lamp Type	Up to 75W Max. A19 light bulb (not supplied)	Up to 75W Max. A19 light bulb (not supplied)																																																																																
Wiring	30" of usable 105°C 18 AWG wire leads. 120V medium base porcelain socket with nickel plated screw shell	30" of usable 105°C 18 AWG wire leads. 120V medium base porcelain socket with nickel plated screw shell																																																																																
Optional Mounting Acces.	15645, 15656, 15657 or 15658 - Stems 15276 - Power Post® 15665, 15666 or 15667 - Bollard Mounting Kits 15578 - Bollard Mounting Stakes 15671 - Bollard Template Kit 15601 - Surface Mounting Flange (for attachment to junction box, not included) 15602 - Flange Mounting Nipple	15645, 15656, 15657 or 15658 - Stems 15276 - Power Post® 15665, 15666 or 15667 - Bollard 15578 - Bollard Mounting Stakes 15671 - Bollard Template Kit 15601 - Surface Mounting Flange (for attachment to junction box, not included) 15602 - Flange Mounting Nipple																																																																																
Fixture Photometric (fc)	<table border="1"> <thead> <tr> <th>Mounting Hgt.</th> <th>1'</th> <th>2'</th> <th>3'</th> <th>4'</th> <th>5'</th> <th>6'</th> <th>7'</th> <th>8'</th> <th>9'</th> </tr> </thead> <tbody> <tr> <td>12"</td> <td>10.1</td> <td>7.7</td> <td>1.7</td> <td>.82</td> <td>.48</td> <td>.21</td> <td>.11</td> <td>-</td> <td>-</td> </tr> <tr> <td>18"</td> <td>4.9</td> <td>4.7</td> <td>2.8</td> <td>1.0</td> <td>.48</td> <td>.27</td> <td>.14</td> <td>.07</td> <td>-</td> </tr> <tr> <td>24"</td> <td>3.2</td> <td>3.5</td> <td>3.4</td> <td>1.3</td> <td>.62</td> <td>.38</td> <td>.21</td> <td>.14</td> <td>.07</td> </tr> </tbody> </table>	Mounting Hgt.	1'	2'	3'	4'	5'	6'	7'	8'	9'	12"	10.1	7.7	1.7	.82	.48	.21	.11	-	-	18"	4.9	4.7	2.8	1.0	.48	.27	.14	.07	-	24"	3.2	3.5	3.4	1.3	.62	.38	.21	.14	.07	<table border="1"> <thead> <tr> <th>Mounting Hgt.</th> <th>1'</th> <th>2'</th> <th>3'</th> <th>4'</th> <th>5'</th> <th>6'</th> <th>7'</th> <th>8'</th> <th>9'</th> </tr> </thead> <tbody> <tr> <td>12"</td> <td>27.1</td> <td>11.7</td> <td>2.8</td> <td>1.2</td> <td>.89</td> <td>.34</td> <td>.18</td> <td>.07</td> <td>-</td> </tr> <tr> <td>18"</td> <td>19</td> <td>9.5</td> <td>4.6</td> <td>1.7</td> <td>.82</td> <td>.45</td> <td>.31</td> <td>.18</td> <td>.07</td> </tr> <tr> <td>24"</td> <td>14.6</td> <td>7.8</td> <td>4.8</td> <td>2.4</td> <td>1</td> <td>.55</td> <td>.27</td> <td>.27</td> <td>.14</td> </tr> </tbody> </table>	Mounting Hgt.	1'	2'	3'	4'	5'	6'	7'	8'	9'	12"	27.1	11.7	2.8	1.2	.89	.34	.18	.07	-	18"	19	9.5	4.6	1.7	.82	.45	.31	.18	.07	24"	14.6	7.8	4.8	2.4	1	.55	.27	.27	.14
Mounting Hgt.	1'	2'	3'	4'	5'	6'	7'	8'	9'																																																																									
12"	10.1	7.7	1.7	.82	.48	.21	.11	-	-																																																																									
18"	4.9	4.7	2.8	1.0	.48	.27	.14	.07	-																																																																									
24"	3.2	3.5	3.4	1.3	.62	.38	.21	.14	.07																																																																									
Mounting Hgt.	1'	2'	3'	4'	5'	6'	7'	8'	9'																																																																									
12"	27.1	11.7	2.8	1.2	.89	.34	.18	.07	-																																																																									
18"	19	9.5	4.6	1.7	.82	.45	.31	.18	.07																																																																									
24"	14.6	7.8	4.8	2.4	1	.55	.27	.27	.14																																																																									

INCANDESCENT 120V / HID PATH & SPREAD



15232 AGZ - CROSS CREEK™ LANTERN **15236 BKT, Tzt - ECLIPSE™** **15239 OB, OZ - TRADITIONAL MARINE LANTERN**

Description	Arts and crafts style path light adds simplicity to the landscape	Large (9"), 120V version of our popular dome-cap Eclipse design to cast a wider light spread on a wide path or patio	Traditional marine lantern design for well-shielded illumination
Ordering Guide & Finish	15232 AGZ - Aged Bronze	15236 BKT - Textured Black 15236 Tzt - Textured Tannery Bronze™	15239 OB - Olde Brick® 15239 OZ - Olde Bronze®
Housing	Aluminum with textured linen seeded glass side panels and clear glass bottom panel	Cast Aluminum with clear glass	Brass
Lamp Type	Up to 25W Max. A19 light bulb (not supplied)	Up to 25W Max. A19 light bulb (not supplied)	Up to 25W Max. A19 light bulb (not supplied)
Wiring	6" Min. of usable 105°C, 18 AWG wire leads. 120V medium base porcelain socket	6" of usable 105°C, 18 AWG wire leads. 120V medium base porcelain socket with a nickel plated screw shell	6" of usable 105° C 18 AWG wire leads. 120V medium base porcelain socket with nickel plated screw shell
Optional Acces.	15276 - Power Post® 15601 - Surface Mounting Flange (for attachment to junction box, not included)	15276 - Power Post® 15601 - Surface Mounting Flange (for attachment to junction box, not included)	15276 - Power Post® 15601 - Surface Mounting Flange (for attachment to junction box, not included)
Notes	U.S. Patent No. D580,084	U.S. Patent No. D580,084	U.S. Patent No. D580,084
Fixture Photometric (fc)	Dist. from Lgt 1' 2' 3' 4' 5' 6' 7' 8' 9' Footcandles 2.8 1.9 .4 .1 - - - - -	Dist. from Lgt 1' 2' 3' 4' 5' 6' 7' 8' 9' Footcandles 30.8 11.5 3.9 1.5 .70 .30 1 - -	Dist. from Lgt 1' 2' 3' 4' 5' 6' 7' 8' 9' Footcandles 76 31 10.2 3.6 1.6 .7 3 .2 .1

INCANDESCENT 120V / HID PATH & SPREAD

P

LED 120V OUTDOOR



11251 AZT, BKT - LED **11250 AZT, BKT - LED** **11077 AZT, BKT - LED**

Description	Up and downlight cylinder can be used to highlight architectural surfaces.	Downlight (only) cylinder can be used to highlight architectural surfaces. Perfect for Dark Sky applications.	Downlight (only) cylinder can be used to highlight architectural surfaces. Perfect for Dark Sky applications.
Ordering Guide & Finish	11251 AZT - Textured Architectural Bronze 11251 BKT - Textured Black	11250 AZT - Textured Architectural Bronze 11250 BKT - Textured Black	11077 AZT - Textured Architectural Bronze 11077 BKT - Textured Black
Housing	Cast Aluminum with powder coat finish and polycarbonate top shield.	Cast Aluminum with powder coat finish.	Cast Aluminum with powder coat finish.
Light Source	Integrated high output Nichia LEDs and Drivers	Integrated high output Nichia LEDs and Drivers	Integrated high output Nichia LEDs and Drivers
Color Temp. (CCT) & CRI	3000K (-50/+50) / Mid 80s CRI	3000K (-50/+50) / Mid 80s CRI	3000K (-50/+50) / Mid 80s CRI
Power Usage	14.67 W	11.23 W	15.42 W
Operating Voltage Range	120V-277V AC, 50-60 Hz	120V-277V AC, 50-60 Hz	120V-277V AC, 50-60 Hz
Lumen Maint.	Tested to an L-70 of 40,000 hours	Tested to an L-70 of 40,000 hours	Tested to an L-70 of 40,000 hours
Total Lumens & Efficacy	574 Lm 39 Lm/W	374 Lm 33 Lm/W	425 Lm 28 Lm/W
Wiring	8" of usable 105° 18 AWG wire leads	8" of usable 105° 18 AWG wire leads	8" of usable 105° 18 AWG wire leads
Fixture Photometric (fc)	Distance from Light 4.2' 8.4' 12.5' 16.7' 20.9' Footcandles 52.1 13.0 5.8 3.3 2.1	Distance from Light 4' 8.3' 12.4' 16.5' 20.6' Footcandles 50.9 12.7 5.7 3.2 2.0	Distance from Light 2.7' 5.5' 8.2' 11.0' 13.7' Footcandles 82.5 20.6 9.2 5.2 3.3



6051 AZ, WH

6052 AZ, WH

Description	Classic single wall or ceiling mounted flood light for use indoors and out.	Classic double wall or ceiling mounted flood light for use indoors and out.
Ordering Guide & Finish	6051 AZ - Architectural Bronze™ 6051 WH - White	6052 AZ - Architectural Bronze™ 6052 WH - White
Housing	Aluminum	Aluminum
Lamp Base	Medium base lamp	Medium base lamp
Supplied Lamp	(1) 120-W Max. BR-40 or 150-W Max. PAR38	(2) 120-W Max. BR-40 or 150-W Max. PAR38
Incandescent Lamp Options	N/A	N/A
LED Lamp Options	12W PAR30 Wet (18087-18092) see page 192 Compares up to 50W Halogen 12W PAR30L Wet (18111-18116) see page 192 Compares up to 50W Halogen 17W PAR38 Wet (18093-18098) see page 192 Compares up to 75W Halogen	12W PAR30 Wet (18087-18092) see page 192 Compares up to 50W Halogen 12W PAR30L Wet (18111-18116) see page 192 Compares up to 50W Halogen 17W PAR38 Wet (18093-18098) see page 192 Compares up to 75W Halogen
Wiring	8" of useable 105° 18 AWG wire leads	8" of useable 105° 18 AWG wire leads
Notes	For LED Lamp photometrics, see page 193	For LED Lamp photometrics, see page 193

Incandescent HID Ballasts

Helping your HID system operate flawlessly.



INCANDESCENT HID BALLASTS



Single Ballast

Twin Ballast

HID ABOVE-GROUND BALLAST

HID IN-GROUND BALLAST

Ordering Guide & Finish	HID ABOVE-GROUND BALLAST				HID IN-GROUND BALLAST			
	Product ID	Description	Tap	ANSI#	Product ID	Description	Tap	ANSI#
	15MHS35 AZT	Single 35-W MH	120V	M130	15IGMHS35 AZ	Single 35-W MH	120V	M130
	15MHS70 AZT	Single 70-W MH	120V	M98	15IGMHS70 AZ	Single 70-W MH	120V	M98
	15MHS100 AZT	Single 100-W MH	120V	M90	15IGMHS100 AZ	Single 100-W MH	120V	M90
	15MHS175 AZT	Single 175-W MH	120V	M57	15IGMHS175 AZ	Single 175-W MH	120V	M57
	15MHT35 AZT	Twin 35-W MH	120V	M130				
	15MHT70 AZT	Twin 70-W MH	120V	M98				
	15MHT100 AZT	Twin 100-W MH	120V	M90				
	15MHT175 AZT	Twin 175-W MH	120V	M57**				
	** Complies with EISA 2007							
Housing	Stamped steel. Textured Architectural Bronze thermoset powder coat finish. Top and bottom mounting brackets. 1/2" and 3/4" trade size combination knockouts for conduit entry. Stainless steel mounting screws and anchors included.				Single piece Polyphenylene Sulphide (PPS) glass reinforced composite with molded in ribs to prevent ground shift. Two 3/4" NPT entries for conduit attachment. With 1/2" NPSM removable plug for both direct fixture mount and remote mount application. Re-enterable encapsulant 3M 8882 potting compound included. One piece, molded silicone "O" Ring. Stainless steel captive and gasketed screws.			
Ballast	Copper wrapped core and coil with High Power Factor (HPF) 105° C High Heat capacitor and long range ignitor. Rated for -20° F starting. Available with single 120V tap.				Quick disconnect ballast with bracket handle. Available with single 120V tap.			
Dimensions	Single 120V: 6.375" W x 9.5" L x 5.25" D Twin 120V: 6.375" W x 15" L x 5.25" D				9.625" Dia. X 12" Hgt.			
Notes	Above ground ballasts carry a UL listing mark suitable for the US and Canadian marketplace. Maximum distance from lamp to ballast cannot exceed 15' on single (120V) models. Some lamp brands may perform better.				In-ground ballasts carry a CSA listing mark suitable for the US and Canadian marketplace Maximum distance from lamp to ballast cannot exceed 15 feet. Some lamp brands may perform better.			







INCANDESCENT HID BALLASTS

B

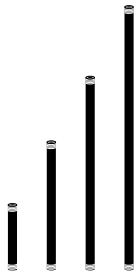



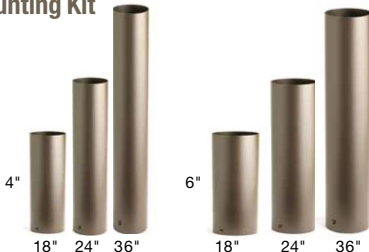



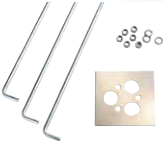

Incandescent / LED 120V / HID Accessories

Create a customized installation.







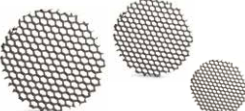





MOUNTING ACCESSORIES	ITEM NUMBER	NOTES						
<p>Fixture Mounting Stems</p>  <p>1/2-14 NPSM thd. stems .75 dia. overall</p>	<table border="0"> <tr> <td>6" 15645 AZT 15645 BBR 15645 BKT</td> <td>18" 15657 AZT 15657 BBR 15657 BKT</td> </tr> <tr> <td>12" 15656 AZT 15656 BBR 15656 BKT</td> <td>24" 15658 AZT 15658 BBR 15658 BKT</td> </tr> </table>	6" 15645 AZT 15645 BBR 15645 BKT	18" 15657 AZT 15657 BBR 15657 BKT	12" 15656 AZT 15656 BBR 15656 BKT	24" 15658 AZT 15658 BBR 15658 BKT	<p>All stems made of corrosion resistant aluminum alloy (except BBR, which is Bronzed Brass) with baked thermoset powder coating to match fixtures. Used with:</p> <ul style="list-style-type: none"> • In-ground support stakes (low voltage only) • Surface mounting flange (low or line voltage) <p>1/2-14 NPSM stems will require additional Coupler (15649) or Elbow (15647) for accent light use</p>		
6" 15645 AZT 15645 BBR 15645 BKT	18" 15657 AZT 15657 BBR 15657 BKT							
12" 15656 AZT 15656 BBR 15656 BKT	24" 15658 AZT 15658 BBR 15658 BKT							
<p>Power Post®</p>  <p>4.375" 19" 2.25"</p>	<p>15276 BKT For use with fixtures 15205 AZT, 15205 BKT, 15211 AZT, 15211 BKT, 15232 AGZ, 15236 BKT, 15236 TZ, 15239 OB & 15239 OZ</p>	<p>Fast, one-step connection. 2¼" inside diameter accepts conduit of different sizes. Made of impact and corrosion resistant PVC, suitable for wet locations. No unsightly junction boxes or time-taking assembly. Just a trouble-free installation. Designed for line voltage (120V) landscape lighting. Eliminates need for above or below ground boxes. Built-in stabilizer removes need for concrete. Accepts 1/2 NPSM thread. UL and cUL listed</p>						
<p>Bollard Mounting Stake</p>  <p>23" H</p>	<p>15578 BK For use with all bollard mounting kits on 12V and 120V fixtures 15005, 15011, 15205, 15211</p>	<p>Improved extruded PVC stake is corrosion resistant and 23" length has increased support and stability. Fitting provided to mount bollard in soil. *As allowed by local electrical codes</p>						
<p>Bollard Mounting Kit</p>  <p>4.0625" ID 4.25" OD</p>	<table border="0"> <tr> <td>18" 15665 AZT 15665 BKT</td> <td>For use with fixtures 15005, 15011, 15205, 15211</td> </tr> <tr> <td>24" 15666 AZT 15666 BKT</td> <td>For use with fixtures 15005, 15011, 15205, 15211</td> </tr> <tr> <td>36" 15667 AZT 15667 BKT</td> <td>For use with fixtures 15005, 15011, 15205, 15211</td> </tr> </table>	18" 15665 AZT 15665 BKT	For use with fixtures 15005, 15011, 15205, 15211	24" 15666 AZT 15666 BKT	For use with fixtures 15005, 15011, 15205, 15211	36" 15667 AZT 15667 BKT	For use with fixtures 15005, 15011, 15205, 15211	<p>Bollard kit is supplied with Cast Aluminum internal mounting plate including lag bolts for deck or surface mounting. Extruded aluminum bollard finished with baked thermoset powder coat. Order separate bollard template kit for installation into concrete or bollard mounting stake for installation in soil. UL listed.</p>
18" 15665 AZT 15665 BKT	For use with fixtures 15005, 15011, 15205, 15211							
24" 15666 AZT 15666 BKT	For use with fixtures 15005, 15011, 15205, 15211							
36" 15667 AZT 15667 BKT	For use with fixtures 15005, 15011, 15205, 15211							
<p>HID Bollard Mounting Kit</p>  <p>4" 18" 24" 36" 6" 18" 24" 36"</p>	<table border="0"> <tr> <td>4" x 18" 15603 AZT 15603 BKT</td> <td>6" x 18" 15613 AZT 15613 BKT</td> </tr> <tr> <td>4" x 24" 15604 AZT 15604 BKT</td> <td>6" x 24" 15614 AZT 15614 BKT</td> </tr> <tr> <td>4" x 36" 15605 AZT 15605 BKT</td> <td>6" x 36" 15615 AZT 15615 BKT</td> </tr> </table> <p>For use with fixtures 15215, 15221, 15226</p>	4" x 18" 15603 AZT 15603 BKT	6" x 18" 15613 AZT 15613 BKT	4" x 24" 15604 AZT 15604 BKT	6" x 24" 15614 AZT 15614 BKT	4" x 36" 15605 AZT 15605 BKT	6" x 36" 15615 AZT 15615 BKT	
4" x 18" 15603 AZT 15603 BKT	6" x 18" 15613 AZT 15613 BKT							
4" x 24" 15604 AZT 15604 BKT	6" x 24" 15614 AZT 15614 BKT							
4" x 36" 15605 AZT 15605 BKT	6" x 36" 15615 AZT 15615 BKT							
<p>Surface Mounting Flange</p>  <p>4" D 1/2-14 NPSM thd</p>	<p>15601 AZT 15601 BBR 15601 BKT 15601 WHT</p>	<p>On 120V installations, Cast Aluminum surface flange must be used with junction box (not included). Neoprene gasket supplied to ensure water tight seal. BBR is Bronzed Cast Brass.</p>						
<p>Flange Mounting Nipple</p>  <p>1/2-14 NPSM thd.</p>	<p>15602 AL</p>	<p>Anodized aluminum nipple. Used when attaching fixture directly to 15601 flange and 15607 bracket.</p>						

INCANDESCENT / LED 120V / HID ACCESSORIES

MOUNTING ACCESSORIES	ITEM NUMBER	NOTES
<p>Junction Box Mounting Bracket</p> <p>2.39" W 5.56" H</p> 	<p>15609 AZT 15609 BKT 15609 WHT</p>	<p>For use with low voltage and line voltage fixtures Corrosion resistant Cast Aluminum alloy with baked thermoset powder coat finish</p>
<p>Bollard Template Kit</p> 	<p>15671 ST</p>	<p>For use with all bollard mounting kits For permanent installation into concrete. Template kit includes positioning template, anchor bolts, and mounting hardware.</p>
<p>Gel Encapsulant</p> 	<p>15616 WH10 10 pack</p>	<p>Re-enterable encapsulant gel for in-ground installations. Two-part field mixable material in one convenient package.</p>
<p>In-Ground Concrete Pour Kit</p> <p>7" D 5.19" H</p> 	<p>15608 AZ for use with 15262, 15263, 15266, 15295</p>	<p>Injection molded concrete pour kit</p>
LENS/SHIELD ACCESSORIES	ITEM NUMBER	NOTES
<p>LED Amber Lens</p>  	<p>16065 AMB for use with 12.5W – 16200, 16201, 16206 16066 AMB for use with 19.5W & 29W – 16202, 16203, 16204, 16205, 16207, 16208</p>	<p>Designed specifically for Kichler Design Pro LED with Radiax Optics, lens offers the ability to create a warmer lighting effect.</p>
<p>LED Green Lens</p>  	<p>16065 GRN for use with 12.5W – 16200, 16201, 16206 16066 GRN for use with 19.5W & 29W – 16202, 16203, 16204, 16205, 16207, 16208</p>	<p>Designed specifically for Kichler Design Pro LED with Radiax Optics, greens of foliage can be intensified to illustrate their true beauty.</p>
<p>LED Frosted Lens</p>  	<p>16065 FRO for use with 12.5W – 16200, 16201, 16206 16066 FRO for use with 19.5W & 29W – 16202, 16203, 16204, 16205, 16207, 16208</p>	<p>Designed specifically for Kichler Design Pro LED with Radiax Optics, creates a soft focus and diffuses the light to provide even, clean illumination</p>
<p>Blue Lens Filter</p> 	<p>15623 BL for use with 15231 15624 BL for use with 15241 15625 BL for use with 15251</p>	<p>Blue glass filters act as color enhancers to bring out the true rich greens of foliage. Glass is tempered to resist heat and impact.</p>
<p>Well Light Blue Lens Filter</p> 	<p>15626 BL for use with 15262, 15263, 15266, 15295</p>	<p>Blue glass filter with rubber gasket. Glass is tempered to resist heat and impact.</p>
<p>45° Hexcell Louver</p> 	<p>15637 BK for use with 15231 15638 BK for use with 15241 15639 BK for use with 15251</p>	<p>Expanded aluminum shield with high temperature black finish.</p>

INCANDESCENT / LED 120V / HID ACCESSORIES

LENS/SHIELD ACCESSORIES	ITEM NUMBER	NOTES
<p>LED Long Cowl</p>  <p>5.8"</p> <p>POWERED BY DESIGN PRO LED TECHNOLOGY Radiax OPTICS</p>	<p>16060 AZT 16060 BBR 16060 WHT for use with 12.5W fixtures 16200, 16201, 16206</p> <p>16062 AZT 16062 BBR 16062 WHT for use with 19.5W & 29W fixtures 16202, 16203, 16204, 16205, 16207, 16208</p>	
<p>LED 360° Short Cowl</p>  <p>16061: 2.5" 16063: 3.3"</p> <p>POWERED BY DESIGN PRO LED TECHNOLOGY Radiax OPTICS</p>	<p>16061 AZT 16061 BBR 16061 WHT for use with 12.5W fixtures 16200, 16201, 16206</p> <p>16063 AZT 16063 BBR 16063 WHT for use with 19.5W & 29W fixtures 16202, 16203, 16204, 16205, 16207, 16208</p>	
<p>Rock Guard</p> 	<p>15688 AZ for use with 15263, 15264, 15265 and 15295</p>	
<p>PAR20 Medium Cowl</p>  <p>3.32" L</p>	<p>15620 AZT 15620 BKT for use with 15231</p>	<p>Lens cowl sold with fixture. 360° rotation for precise light cutoff.</p>
<p>PAR20 Long Cowl</p>  <p>7.45" L</p>	<p>15628 AZT 15628 BKT for use with 15231</p>	
<p>PAR30 Medium Cowl</p>  <p>3.87" L</p>	<p>15640 AZT 15640 BKT for use with 15241</p>	
<p>PAR30 Long Cowl</p>  <p>8.99" L</p>	<p>15648 AZT 15648 BKT for use with 15241</p>	
<p>PAR38 Medium Cowl</p>  <p>4.92"</p>	<p>15660 AZT 15660 BKT for use with 15251, 15255</p>	
<p>PAR38 Long Cowl</p>  <p>12" L</p>	<p>15668 AZT for use with 15251 & 15255</p>	
<p>PAR20 Cowl</p>  <p>3.58" L</p>	<p>15630 AZ for use with 15230</p>	<p>Heat-resistant clear lens</p>
<p>PAR38 Cowl</p>  <p>3.58"</p>	<p>15650 AZT for use with 15250</p>	<p>Heat-resistant clear lens</p>

LED 120V Lamps

Landscape LED lamps developed the Kichler way.



Proven LED performance,
superior savings and a
broad range of options for
landscape lighting systems

We've taken everything we know about LED technology and created a new line of lamps that help save money without sacrificing performance. Designed to fit landscape, outdoor, and security lighting fixtures for both 12V and 120V-277V systems. Kichler® LED lamps offer superior cost savings in terms of energy use and total cost of ownership. You'll also find an exceptional variety of lamp options so you can create the lighting look you want. And, because they're from Kichler, you are assured that the lamps will perform and last.



120V FEATURES

- ★ Potted and/or coated electronics protect against moisture
- ★ Operating range from 120V to 277V
- ★ Standard versions designed and listed for use in an enclosed fixture
- ★ Wet location versions designed and listed for use in an enclosed or open fixture
- ★ Cast aluminum heat sink, anodized black, for increased thermal management
- ★ Integrated driver and transformer with high output Cree®* LEDs tightly binned for high CRI, color uniformity and color quality
- ★ 30,000 hour life in an enclosed fixture
- ★ FCC compliance ensures no interference with other electronic devices
- ★ High total lumens and lumens per watt (efficacy)
- ★ Custom optics deliver center-to-edge beam uniformity



* Cree is a registered trademark of Cree, Inc.

120v-277v LED LAMPS

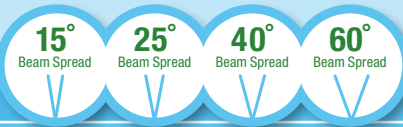

Base / Lamp Type	Watts	Kelvin / Lumens	Beam Angle			
PAR20 - Standard** 	7W Compares up to 35W Halogen		15° Spot	25° Wide Spot	40° Flood	60° Wide Flood
		2700K - Warm White 330Lm	18045	18048	18051	18054
		3000K - Pure White 360Lm	18046	18049	18052	18055
		4200K - Cool White 400Lm	18047	18050	18053	18056
PAR30 - Standard** 	12W Compares up to 50W Halogen		15° Spot	25° Wide Spot	40° Flood	60° Wide Flood
		2700K - Warm White 650Lm	18057	18060	18063	18066
		3000K - Pure White 700Lm	18058	18061	18064	18067
		4200K - Cool White 750Lm	18059	18062	18065	18068
PAR30 - Standard** Longneck 	12W Compares up to 50W Halogen		15° Spot	25° Wide Spot	40° Flood	60° Wide Flood
		2700K - Warm White 650Lm	18099	18102	18105	18108
		3000K - Pure White 700Lm	18100	18103	18106	18109
		4200K - Cool White 750Lm	18101	18104	18107	18110
PAR38 - Standard** 	17W Compares up to 75W Halogen		15° Spot	25° Wide Spot	40° Flood	60° Wide Flood
		2700K - Warm White 800Lm	18069	18072	18075	18078
		3000K - Pure White 850Lm	18070	18073	18076	18079
		4200K - Cool White 900Lm	18071	18074	18077	18080
PAR20 - Wet*** Location 	7W Compares up to 35W Halogen		25° Wide Spot		40° Flood	
		2700K - Warm White 310Lm	18081		18084	
		3000K - Pure White 330Lm	18082		18085	
		4200K - Cool White 350Lm	18083		18086	
PAR30 - Wet*** Location 	12W Compares up to 50W Halogen		25° Wide Spot		40° Flood	
		2700K - Warm White 580Lm	18087		18090	
		3000K - Pure White 610Lm	18088		18091	
		4200K - Cool White 640Lm	18089		18092	
PAR30 - Wet*** Location Longneck 	12W Compares up to 50W Halogen		25° Wide Spot		40° Flood	
		2700K - Warm White 580Lm	18111		18114	
		3000K - Pure White 610Lm	18112		18115	
		4200K - Cool White 640Lm	18113		18116	
PAR38 - Wet*** Location 	17W Compares up to 75W Halogen		25° Wide Spot		40° Flood	
		2700K - Warm White 800Lm	18093		18096	
		3000K - Pure White 850Lm	18094		18097	
		4200K - Cool White 900Lm	18095		18098	

** Standard versions designed and listed for use in an enclosed fixture.

***Wet location versions designed and listed for use in an enclosed or open fixture.

Stated lumens are for bare lamp only. Using lamp in enclosed fixtures can result in up to 30-50% loss in lumen output based on test data.

120V-277V PHOTOMETRICS

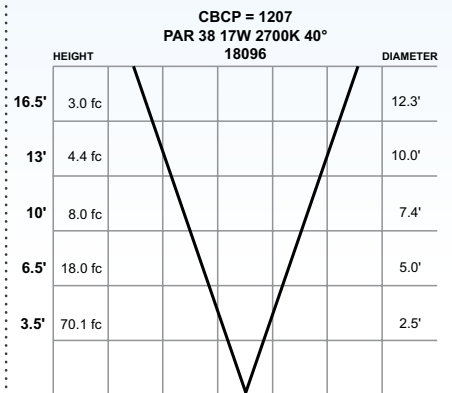
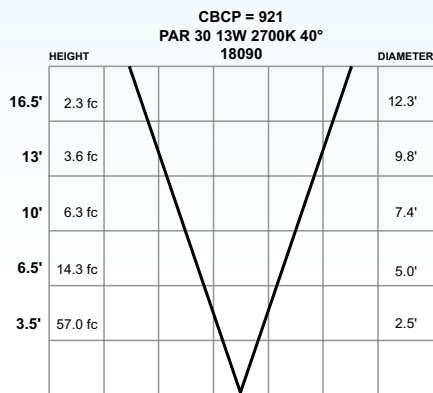
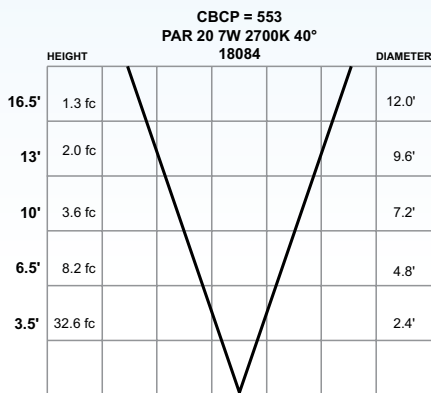
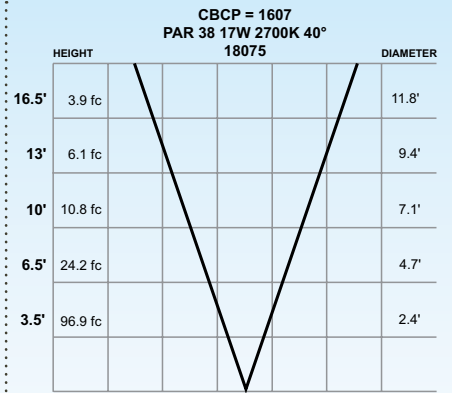
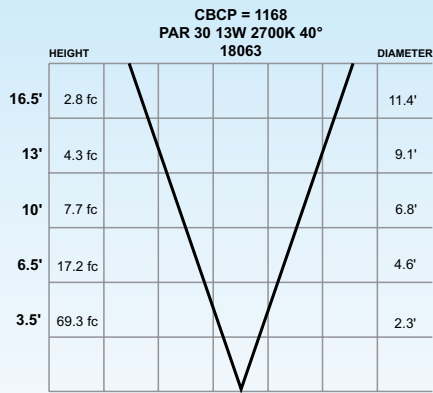
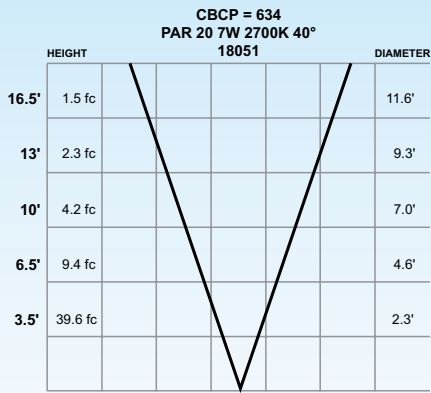

* The curves indicate the illuminated area and the average illumination when the luminaire is at different distances. Stated footcandles are for bare lamps only. For additional photometrics, visit landscapelighting.com

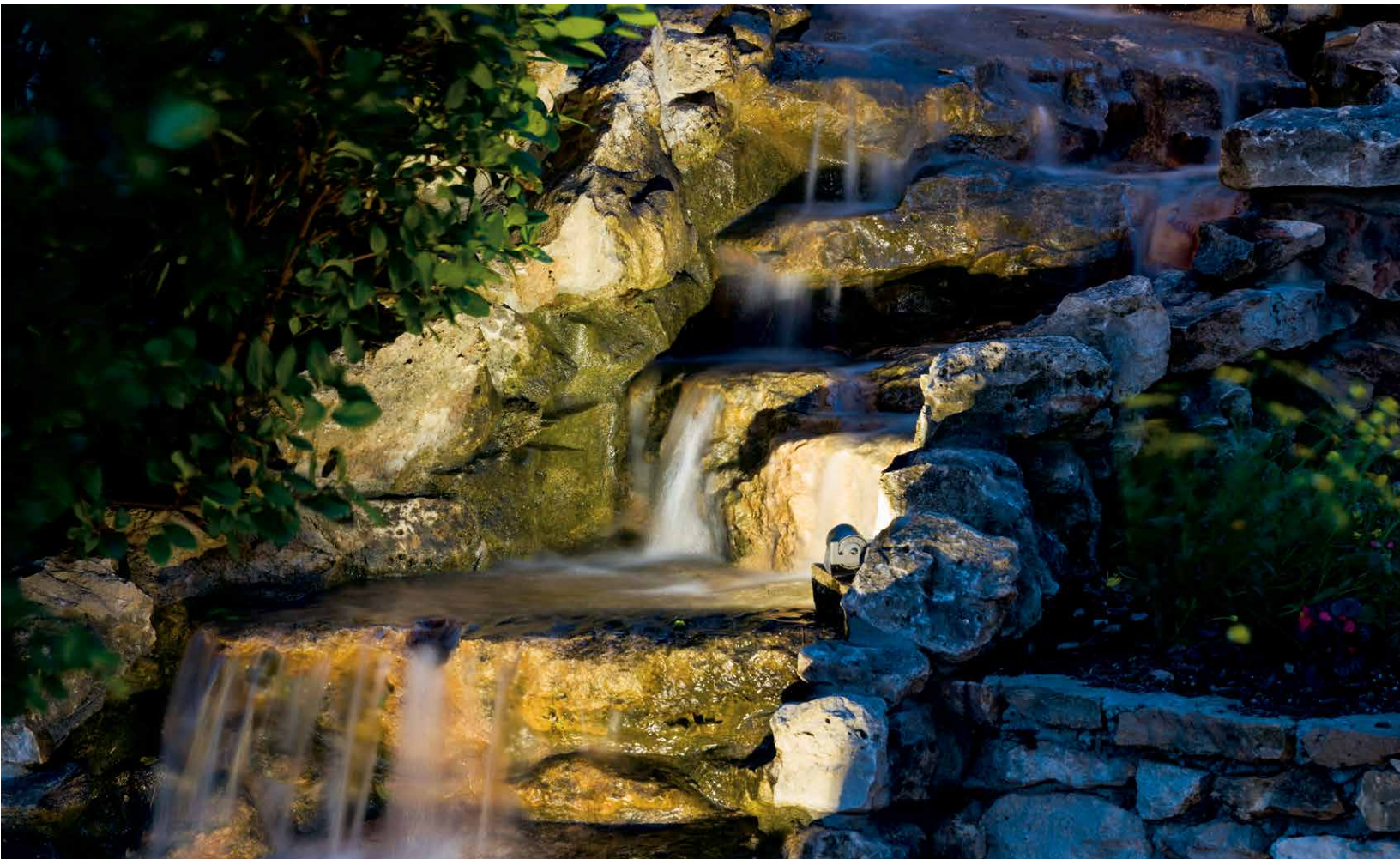



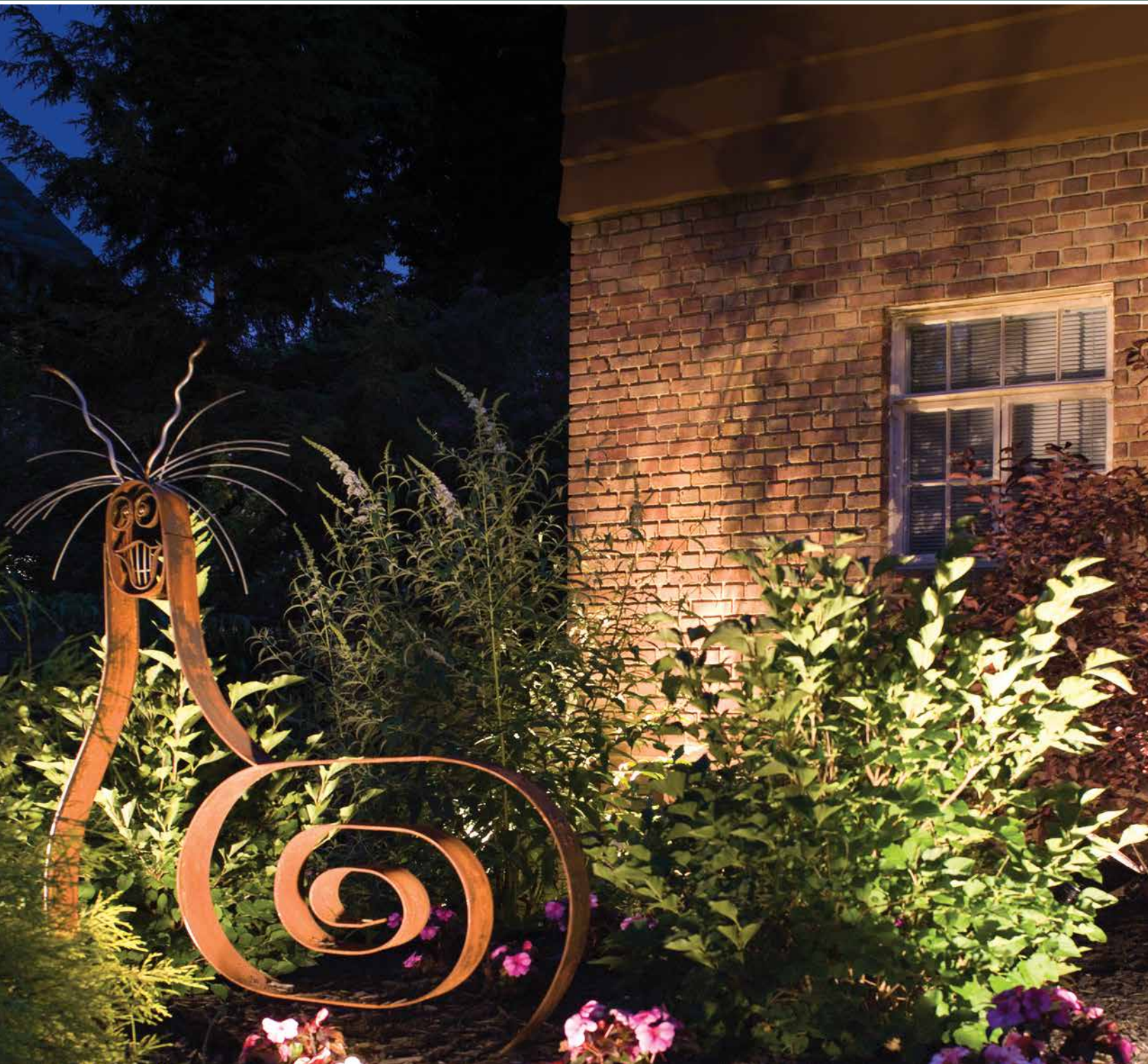







Incandescent 120V / HID Lamps & Photometrics

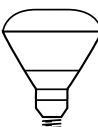

INCANDESCENT 120V HID LAMPS & PHOTOMETRICS

INCANDESCENT 120V / HID LAMPS & PHOTOMETRICS

L

Lamp Type	Watts	Beam Spread	Base	Lumens	Avg. Life (hrs)	
INCANDESCENT						
	30R20-SP	30	Spot	Medium	300	2,000
	30R20-FL	30	Flood	Medium	300	2,000
	50R20-SP	50	Spot	Medium	550	2,000
	50R20-FL	50	Flood	Medium	550	2,000
	75R30-SP	75	Spot	Medium	770	2,000
	75R30-FL	75	Flood	Medium	770	2,000
	65R40-SP	65	Spot	Medium	500	2,000
	65R40-FL	65	Flood	Medium	500	2,000
	85R40-SP	85	Spot	Medium	700	2,000
	85R40-FL	85	Flood	Medium	700	2,000
	120R40-SP	120	Spot	Medium	1,000	2,000
	120R40-FL	120	Flood	Medium	1,000	2,000
HALOGEN						
	35PAR20-SP	35	9°	Medium	350	2,000
	35PAR20-FL	35	30°	Medium	350	2,000
	50PAR20-SP	50	9°	Medium	550	2,000
	50PAR20-FL	50	30°	Medium	550	2,000
	50PAR30L-SP	50	10°	Medium	630	2,000
	50PAR30L-FL	50	30°	Medium	630	2,000
	75PAR30L-SP	75	10°	Medium	965	2,000
	75PAR30L-FL	75	30°	Medium	965	2,000
	90PAR38-SP	90	12°	Medium	1,280	2,500
	90PAR38-FL	90	28°	Medium	1,280	2,500
	150PAR38-SP	150	12°	Medium	2,200	2,500
	150PAR38-FL	150	28°	Medium	2,200	2,500
METAL HALIDE						
	70-ED17	70	-	Medium	4,000	10,000
	100-ED17	100	-	Medium	5,850	10,000
	35PAR20-SP	35	10°	Medium	2,000	9,000
	35PAR20-FL	35	30°	Medium	2,000	9,000
	35PAR30L-SP	35	10°	Medium	2,200	9,000
	35PAR30L-FL	35	30°	Medium	2,200	9,000
	70PAR30L-SP	70	10°	Medium	4,850	9,000
	70PAR30L-FL	70	40°	Medium	4,850	9,000
	70PAR38-SP	70	15°	Medium	4,800	10,000
	70PAR38-FL	70	25°	Medium	4,800	10,000
	100PAR38-SP	100	15°	Medium	6,800	12,500
	100PAR38-FL	100	25°	Medium	6,800	12,500
	175PAR38-FL	175	65°	Medium	10,000	7,500

Code: VN-SP - Very narrow spot NSP - Narrow spot SP - Spot NFL - Narrow flood FL - Flood WFL - Wide flood
 VWFL - Very wide flood MEDIUM - Medium screwshell

Note: Lumens and lamp life may vary by manufacturer.
 Stated lumens are of bare lamp.

INCANDESCENT 120V HID LAMPS & PHOTOMETRICS

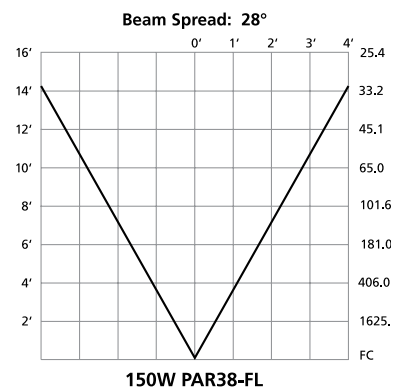
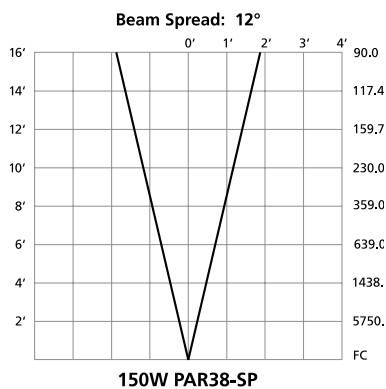
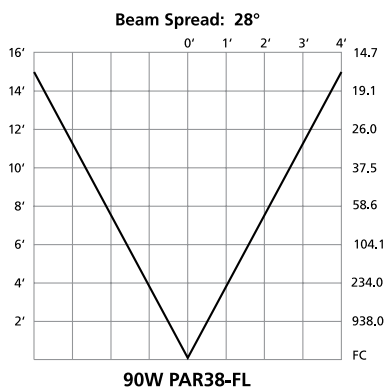
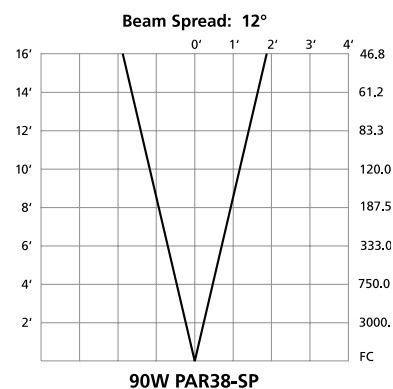
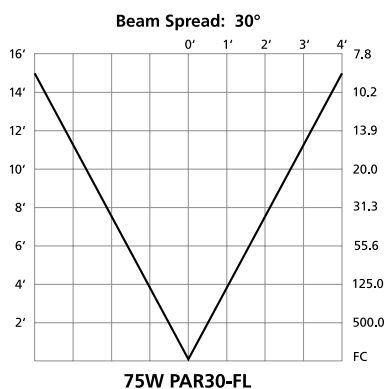
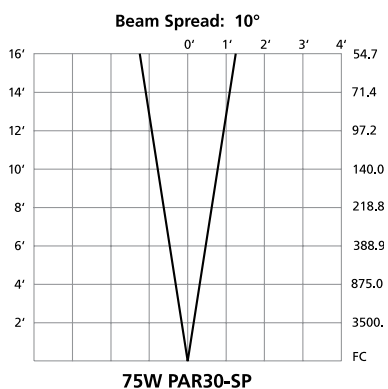
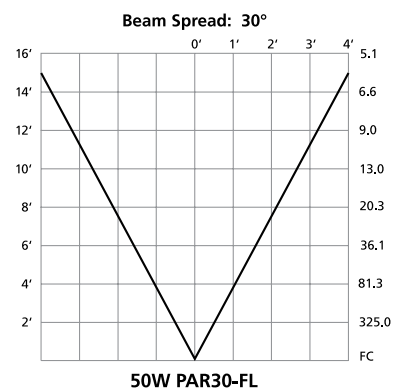
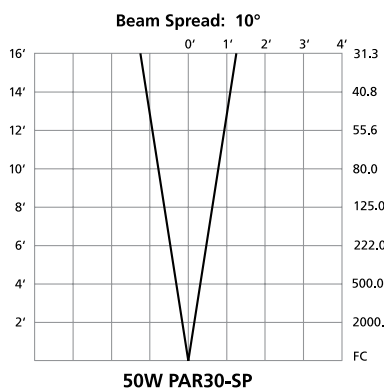
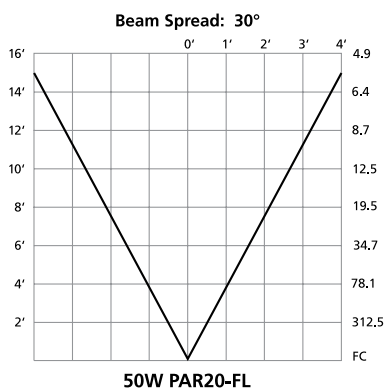
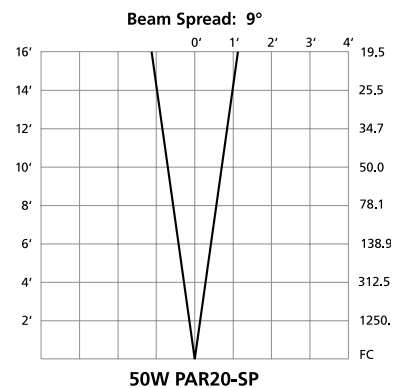
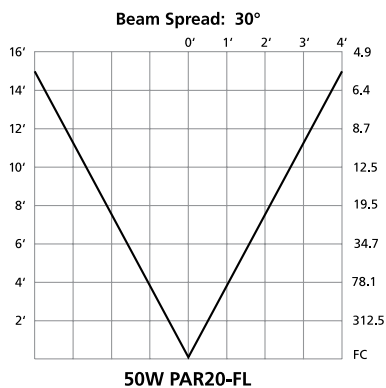
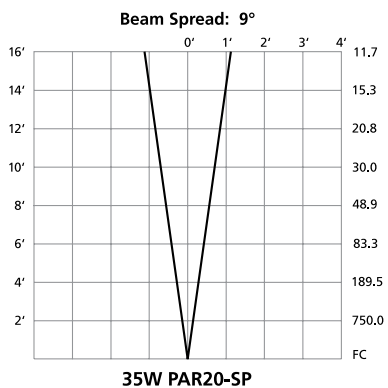

Note: Footcandle (FC) values may differ amongst lamp manufacturers.



KICHLER®

Incandescent / LED Fixture Photometrics



LED 12V FIXTURE PHOTOMETRICS

10° SPOT		15731 & 15767		15741 & 15728		15751 & 15729		16000		16003		16006		
Feet	Foot Candles	Beam Width	Foot Candles	Beam Width	Foot Candles	Beam Width	Foot Candles	Beam Width	Foot Candles	Beam Width	Foot Candles	Beam Width	Foot Candles	Beam Width
8	33.6	1.2	68.3	1.2	100.6	1.3	20	1.8	22.2	2.1	106.3	1.6	8.9	2.7
12	14.9	1.8	30.4	1.9	44.7	1.9	8.9	2.7	9.9	3.1	48.4	2.4	2.2	5.4
24	3.73	3.6	7.60	3.8	11.18	3.8	2.2	5.4	2.5	6.2	12.2	4.8	1	8.1
36	1.66	5.4	3.38	5.7	4.97	5.7	1	8.1	1.1	9.3	5.4	7.2	0.6	10.8
48	0.93	7.2	1.90	7.6	2.79	7.6	0.6	10.8	0.6	12.4	3.1	9.6	0.4	13.5
60	0.60	9	1.22	9.5	1.79	9.5	0.4	13.5	0.4	15.5	2	12		

35° FLOOD		15732 & 15768		15742 & 15747		15752 & 15757		16001		16004		16007		
Feet	Foot Candles	Beam Width	Foot Candles	Beam Width	Foot Candles	Beam Width	Foot Candles	Beam Width	Foot Candles	Beam Width	Foot Candles	Beam Width	Foot Candles	Beam Width
4	35.78	1.9	66.94	1.8	98.1	2.07	16.3	2.2	21.7	2.3	66.1	2.3	4.1	4.5
8	9	3.9	16.75	3.6	24.5	4.1	4.1	4.5	5.4	4.5	16.5	4.5	1	9
16	2.2	7.8	4.15	7.3	6.1	8.2	1	9	1.4	9	4.1	9.1	0.5	13.5
24	0.98	11.7	1.84	10.95	2.71	12.3	0.5	13.5	0.6	13.5	1.8	13.6	0.3	18
32	0.55	15.6	1.04	14.6	1.53	16.4	0.3	18	0.3	18	1	18.1	0.2	22.5
40	0.35	19.5	0.66	18.25	0.98	20.5	0.2	22.5	0.2	22.5	0.7	22.6		

60° WIDE FLOOD		15733 & 15769		15743 & 15748		15753 & 15758		15711 LED		16002		16005		16008		
Feet	Foot Candles	Beam Width	Foot Candles	Beam Width	Foot Candles	Beam Width	Foot Candles	Beam Width	Foot Candles	Beam Width	Foot Candles	Beam Width	Foot Candles	Beam Width	Foot Candles	Beam Width
4	18.54	2.4	36.9	2.4	47.03	2.4	5.6	3.25	6.8	4	11.2	4.3	15	4.2		
8	4.65	4.8	9.3	4.8	11.8	4.8	1.49	6.5	1.7	7.9	2.8	8.6	3.7	8.5		
16	1.15	9.6	2.3	9.6	2.9	9.6	.40	12.98	0.4	15.8	0.7	17.3	0.9	17		
24	0.51	14.4	1.02	14.4	1.29	14.4	.18	19.47	0.2	23.7	0.3	25.9	0.4	25.5		
32	0.29	19.2	0.58	19.2	0.73	19.2	.11	25.96	0.1	31.6	0.2	34.6	0.2	34		
40	0.18	24	0.37	24	0.46	24	.07	32.45	0.1	39.5	0.1	43.2	0.2	42.4		







10° SPOT		16009		16012		16030		16033		16036		16200		16202		16204		
Feet	Foot Candles	Beam Width	Foot Candles	Beam Width	Foot Candles	Beam Width	Foot Candles	Beam Width	Foot Candles	Beam Width	Foot Candles	Beam Width	Foot Candles	Beam Width	Foot Candles	Beam Width	Foot Candles	Beam Width
8	187.2	1.5	252	2	32.6	1.6	113.8	1.4	214.7	1.4	238.9	1.4	313.3	1.6	394.5	1.6		
12	83.2	2.3	112	3	14.5	2.3	50.6	2.1	95.4	2	106.2	2.1	139.2	2.4	175.3	2.5		
24	20.8	4.6	27	6	3.6	4.7	12.6	4.3	23.8	4.1	26.5	4.1	34.8	4.9	43.8	4.9		
36	9.2	6.9	12.4	8.9	1.6	7	5.6	6.4	10.6	6.1	11.8	6.2	15.5	7.3	19.5	7.4		
48	5.2	9.2	7.1	11.9	0.9	9.3	3.2	8.6	6	8.1	6.6	8.3	8.7	9.7	11	9.8		
60	3.3	11.6	4.5	14.9	0.6	11.7	2	10.7	3.8	10.1	4.2	10.3	5.6	12.1	7	12.3		

35° FLOOD		16010		16013		16031		16034		16037		16201		16203		16205		
Feet	Foot Candles	Beam Width	Foot Candles	Beam Width	Foot Candles	Beam Width	Foot Candles	Beam Width	Foot Candles	Beam Width	Foot Candles	Beam Width	Foot Candles	Beam Width	Foot Candles	Beam Width	Foot Candles	Beam Width
4	99.6	2.3	138.8	2.5	21.7	2.3	53	2.4	98.5	2.3	112.6	2.3	153.2	2.5	205.8	2.4		
8	24.9	4.6	34.7	4.9	5.4	4.5	13.3	4.7	24.6	4.5	28.1	4.5	38.3	4.9	51.5	4.8		
16	6.2	9.1	8.7	9.8	1.4	9	3.3	9.4	6.1	9.1	7	9	9.6	9.9	13.2	9.6		
24	2.8	13.7	3.9	14.8	0.6	13.5	1.5	14.1	2.7	13.6	3.1	13.6	4.3	14.8	5.9	14.4		
32	1.6	18.2	2.2	19.7	0.3	18	0.8	18.9	1.5	18.1	1.8	18.1	2.4	19.8	3.3	19.2		
40	1	22.8	1.4	24.6	0.2	22.5	0.5	23.6	1	22.6	1.1	22.6	1.5	24.7	2.1	24		

60° WIDE FLOOD		16011		16014		16032		16035		16038		16206		16207		16208		
Feet	Foot Candles	Beam Width	Foot Candles	Beam Width	Foot Candles	Beam Width	Foot Candles	Beam Width	Foot Candles	Beam Width	Foot Candles	Beam Width	Foot Candles	Beam Width	Foot Candles	Beam Width	Foot Candles	Beam Width
4	26.4	4.4	43.2	4.2	11.2	4.3	14.7	4.5	25.1	4.4	26	4.2	43.4	4.1	53.5	4.2		
8	6.6	8.8	10.8	8.5	2.8	8.6	3.7	9.1	6.3	8.8	6.5	8.4	10.8	8.1	13.4	8.3		
16	1.7	17.5	2.7	16.9	0.7	17.3	0.9	18.1	1.6	17.7	1.6	16.9	2.7	16.3	3.4	16.7		
24	0.7	26.3	1.2	25.4	0.3	25.9	0.4	27.2	0.7	26.5	0.7	25.3	1.2	24.4	1.5	25.0		
32	0.4	35	0.7	33.9	0.2	34.6	0.2	36.2	0.4	35.3	0.4	33.7	0.7	32.6	0.8	33.3		
40	0.3	43.8	0.4	42.3	0.1	43.2	0.1	45.3	0.3	44.2	0.3	42.4	0.4	40.7	0.5	41.6		

- All Foot Candle values shown for 3000K color temperature, except 16200 -16208 (4250K)
- For 2700K reduce by 10%.
- For 4250K increase by 20%.

INCANDESCENT 12V FIXTURE PHOTOMETRICS

SPOT		17050 MR11 - 20-W FTB, JDR/M12V-20-W/G/SP10		17055 MR11 - 35-W FTE, JDR/M12V-35-W/G/SP12		17060 MR16 - 20-W ESX, JR12V-20-W/SP12		17070 MR16 - 35-W FMT/FBR, JR12V-35-W/SP12		17080 MR16 - 50-W EXT, JR12V-50-W/SP12		17090 MR16 - 75-W EYF, JR12V-75-W/SP12		
Feet		Foot Candles	Beam Width	Foot Candles	Beam Width	Foot Candles	Beam Width	Foot Candles	Beam Width	Foot Candles	Beam Width	Foot Candles	Beam Width	
		8	47.3	1.39	75.7	1.68	55	1.68	95	1.68	174	1.68	205	1.68
		12	21	2.09	33.6	2.52	24	2.52	42	2.52	77	2.52	91	2.52
		24	5.25	4.19	8.41	5.04	6.1	5.04	10.5	5.04	19.3	5.04	22	5.04
		36	2.42	6.29	3.88	7.56	2.7	7.56	4.6	7.56	8.5	7.56	10.1	7.56
		48	1.31	8.39	2.1	10	1.5	10.09	2.6	10.09	4.8	10.09	5.7	10.09
		60	0.84	1.04	1.34	12.6	0.98	12.6	1.6	12.6	3	12.6	3.6	12.6
SPOT/NARROW FLOOD		17051 MR11 - 20-W FTC, JDR/M12V-20-W/G/SP17		17056 MR11 - 35-W FTF, JDR/M12V-35-W/G/SP20		17061 MR16 - 20-W BBF, JR12V-20-W/NFL24		17071 MR16 - 35-W FMV/FRA, JR12V-35-W/NFL24		17081 MR16 - 50-W EXZ, JR12V-50-W/NFL24		17091 MR16 - 75-W EYJ, JR12V-75-W/NFL24		
Feet		Foot Candles	Beam Width	Foot Candles	Beam Width	Foot Candles	Beam Width	Foot Candles	Beam Width	Foot Candles	Beam Width	Foot Candles	Beam Width	
		8	22.1	2.39	37.7	2.82	18.8	3.4	36	3.4	57	3.4	76	3.4
		12	9.83	3.58	16.7	4.23	8.4	5.1	16	5.1	25	5.1	34	5.1
		24	2.45	7.17	4.19	8.46	2.1	10.2	4.04	10.2	6.3	10.2	8.4	10.2
		36	1.13	10.73	1.94	12.7	0.9	15.3	1.7	15.3	2.8	15.3	3.7	15.3
		48	0.61	14.4	1.04	16.9	0.5	20.4	1	20.4	1.6	20.4	2.1	20.4
		60	0.39	17.9	0.67	21.1	0.3	25.5	0.6	25.5	1	25.5	1.3	25.5
FLOOD		17052 MR11 - 20-W FTD, JDR/M12V-20-W/G/FL30		17057 MR11 - 35-W FTH, JDR/M12V-35-W/G/FL30		17062 MR16 - 20-W BAB, JR12V-20-W/FL36		17072 MR16 - 35-W FMW, JR12V-35-W/FL36		17082 MR16 - 50-W EXN, JR12V-50-W/FL36		17092 MR16 - 75-W EYC, JR12V-75-W/FL36		
Feet		Foot Candles	Beam Width	Foot Candles	Beam Width	Foot Candles	Beam Width	Foot Candles	Beam Width	Foot Candles	Beam Width	Foot Candles	Beam Width	
		4	37.9	2.14	81.6	2.14	38	2.6	82	2.6	126	2.6	170	2.13
		8	9.48	4.28	20.4	4.28	9.5	5.1	20	5.1	31	5.1	42	5.1
		16	2.37	8.57	5.1	8.57	2.4	10.4	5	10.4	8	10.4	10	10.4
		24	1.05	12.8	2.26	12.8	1	15.5	2	15.5	3.5	15.5	4.7	15.5
		32	0.59	17.1	1.27	17.1	0.6	20.7	1.3	20.7	2	20.7	2.6	20.7
		40	0.37	25.7	0.82	21.4	0.3	25	0.8	25	1.2	25	1.7	25
WIDE FLOOD						17063 MR16 - 20-W BAB/60, JR12V-20-W/WFL60		17073 MR16 - 35-W FMW/60, JR12V-35-W/WFL60		17083 MR16 - 50-W FNV, JR12V-50-W/WFL60		17093 MR16 - 75-W EYC/60, JR12V-75-W/WFL60		
Feet						Foot Candles	Beam Width	Foot Candles	Beam Width	Foot Candles	Beam Width	Foot Candles	Beam Width	
						4	17	4.6	32	4.6	54	4.6	77	4.6
						8	4.2	9.2	8	9.2	13	9.2	19	9.2
						16	1.1	18.5	2	18.5	3.3	18.5	4.8	18.5
						24	0.5	27.7	0.8	27.7	1.5	27.7	2.1	27.7
						32	0.3	36	0.5	36	0.8	36	1.2	36
						40	0.17	46	0.4	39	0.5	46	0.7	46
SPOT		17030 20PAR36/ NSP8/12V		17037 35PAR36/ NSP8/12V		17044 50PAR36/ NSP8/12V								
Feet		Foot Candles	Beam Width	Foot Candles	Beam Width	Foot Candles	Beam Width							
		8	55.3	1.11	118	1.11	213	1.11						
		12	24.5	1.67	52.6	1.67	94.8	1.67						
		24	6.14	3.35	13.1	3.35	23.7	3.35						
		36	2.73	5.03	5.84	5.03	10.5	5.03						
		48	1.53	6.71	3.28	6.71	5.92	6.71						
		60	0.98	8.39	2.1	8.39	3.79	8.39						
SPOT/NARROW FLOOD		17032 20PAR36/ NFL20/12V		17039 35PAR36/ NFL20/12V		17046 50PAR36/ NFL20/12V								
Feet		Foot Candles	Beam Width	Foot Candles	Beam Width	Foot Candles	Beam Width							
		8	20.4	2.82	39.4	2.82	78.9	2.82						
		12	9.07	4.23	17.5	4.23	35	4.23						
		24	2.26	8.46	4.38	8.46	8.77	8.46						
		36	1	12.6	1.94	12.6	3.89	12.6						
		48	0.56	16.9	1.09	16.9	2.19	16.9						
		60	0.36	21.1	0.7	21.1	1.4	21.1						
FLOOD		17033 20PAR36/ FL30/12V		17040 35PAR36/ FL30/12V		17047 50PAR36/ FL30/12V								
Feet		Foot Candles	Beam Width	Foot Candles	Beam Width	Foot Candles	Beam Width							
		4	46.9	2.14	88.4	2.14	125	2.14						
		8	11.7	2.48	22.1	4.28	31.4	4.28						
		16	2.93	8.57	5.53	8.57	7.86	8.57						
		24	1.3	12.8	2.45	12.8	3.49	12.8						
		32	1.06	17.07	1.77	16.0	2.52	16.0						
		40	.49	21.3	.93	21.37	1.32	21.37						

INCANDESCENT 120V & HID FIXTURE PHOTOMETRICS

75-W Metal Halide
Clear ED17 Metal Halide
based on 5000 lumens
per lamp

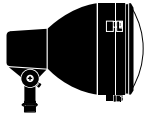

15251

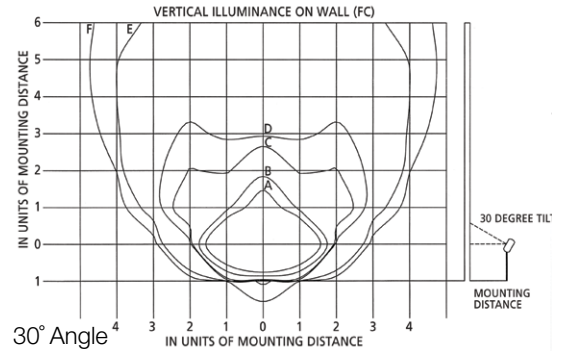
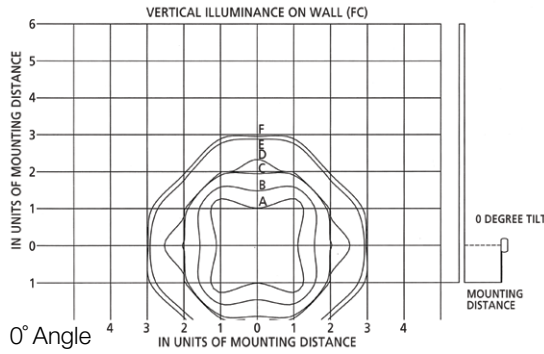

Vertical Illuminance (FC)

MD(FT)	A	B	C	D	E	F
3	13.89	8.33	2.78	1.39	0.28	0.14
4	7.81	4.69	1.56	0.78	0.16	0.08
5	5.00	3.00	1.00	0.50	0.10	0.05
6	3.47	2.08	0.69	0.35	0.07	0.03
7	2.55	1.53	0.51	0.26	0.05	0.03
8	1.95	1.17	0.39	0.20	0.04	0.02
9	1.54	0.93	0.31	0.15	0.03	0.02
10	1.25	0.75	0.25	0.13	0.03	0.01

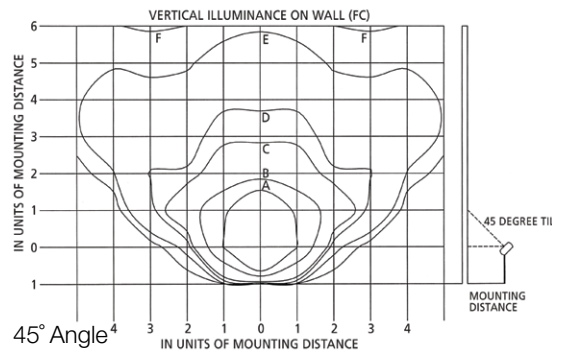

100-W Metal Halide
Clear ED17 Metal Halide
based on 9000 lumens
per lamp

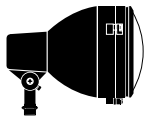

15251

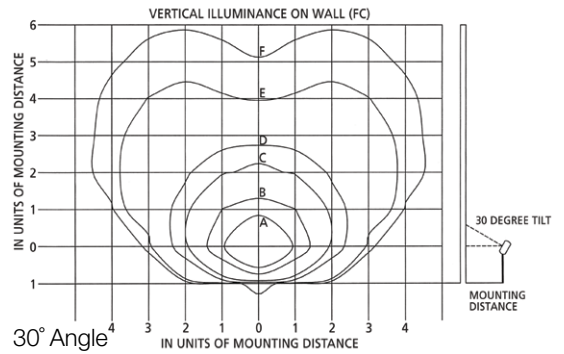
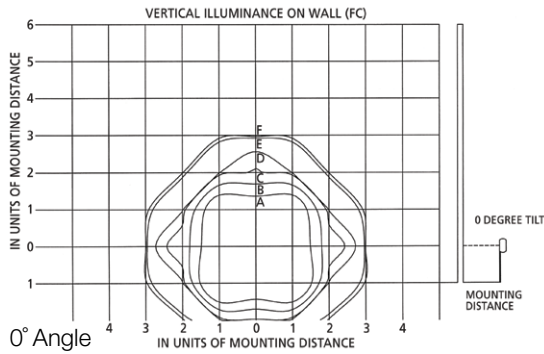

Vertical Illuminance (FC)

MD(FT)	A	B	C	D	E	F
3	13.89	8.33	2.78	1.39	0.28	0.14
4	7.81	4.69	1.56	0.78	0.16	0.08
5	5.00	3.00	1.00	0.50	0.10	0.05
6	3.47	2.08	0.69	0.35	0.07	0.03
7	2.55	1.53	0.51	0.26	0.05	0.03
8	1.95	1.17	0.39	0.20	0.04	0.02
9	1.54	0.93	0.31	0.15	0.03	0.02
10	1.25	0.75	0.25	0.13	0.03	0.01

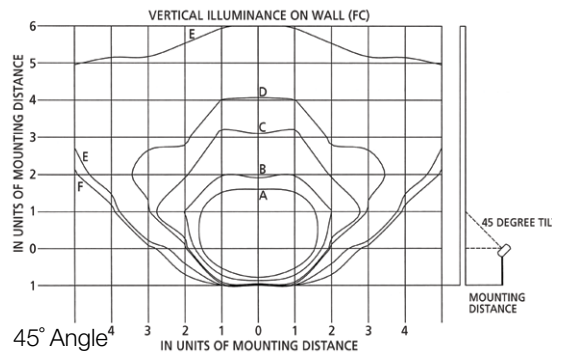

INCANDESCENT 120V & HID FIXTURE PHOTOMETRICS

175-W Metal Halide
Clear ED17 Metal Halide
based on 14000 lumens
per lamp

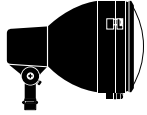

15251

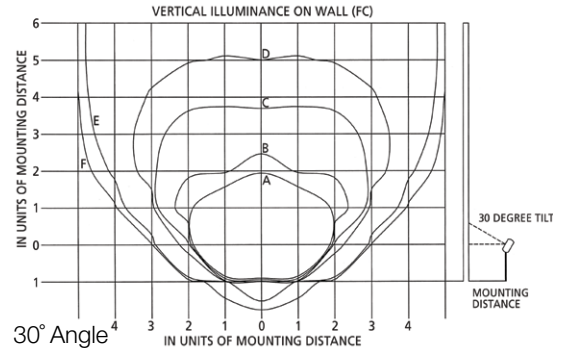
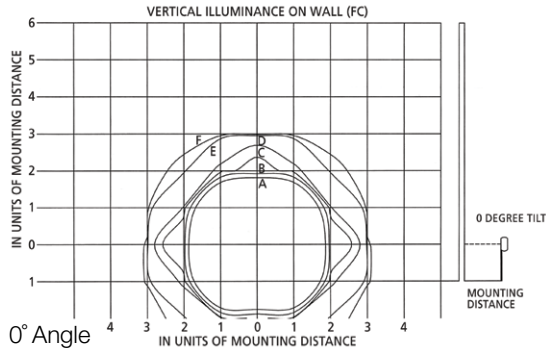

Vertical Illuminance (FC)

MD(FT)	A	B	C	D	E	F
3	13.89	8.33	2.78	1.39	0.28	0.14
4	7.81	4.69	1.56	0.78	0.16	0.08
5	5.00	3.00	1.00	0.50	0.10	0.05
6	3.47	2.08	0.69	0.35	0.07	0.03
7	2.55	1.53	0.51	0.26	0.05	0.03
8	1.95	1.17	0.39	0.20	0.04	0.02
9	1.54	0.93	0.31	0.15	0.03	0.02
10	1.25	0.75	0.25	0.13	0.03	0.01

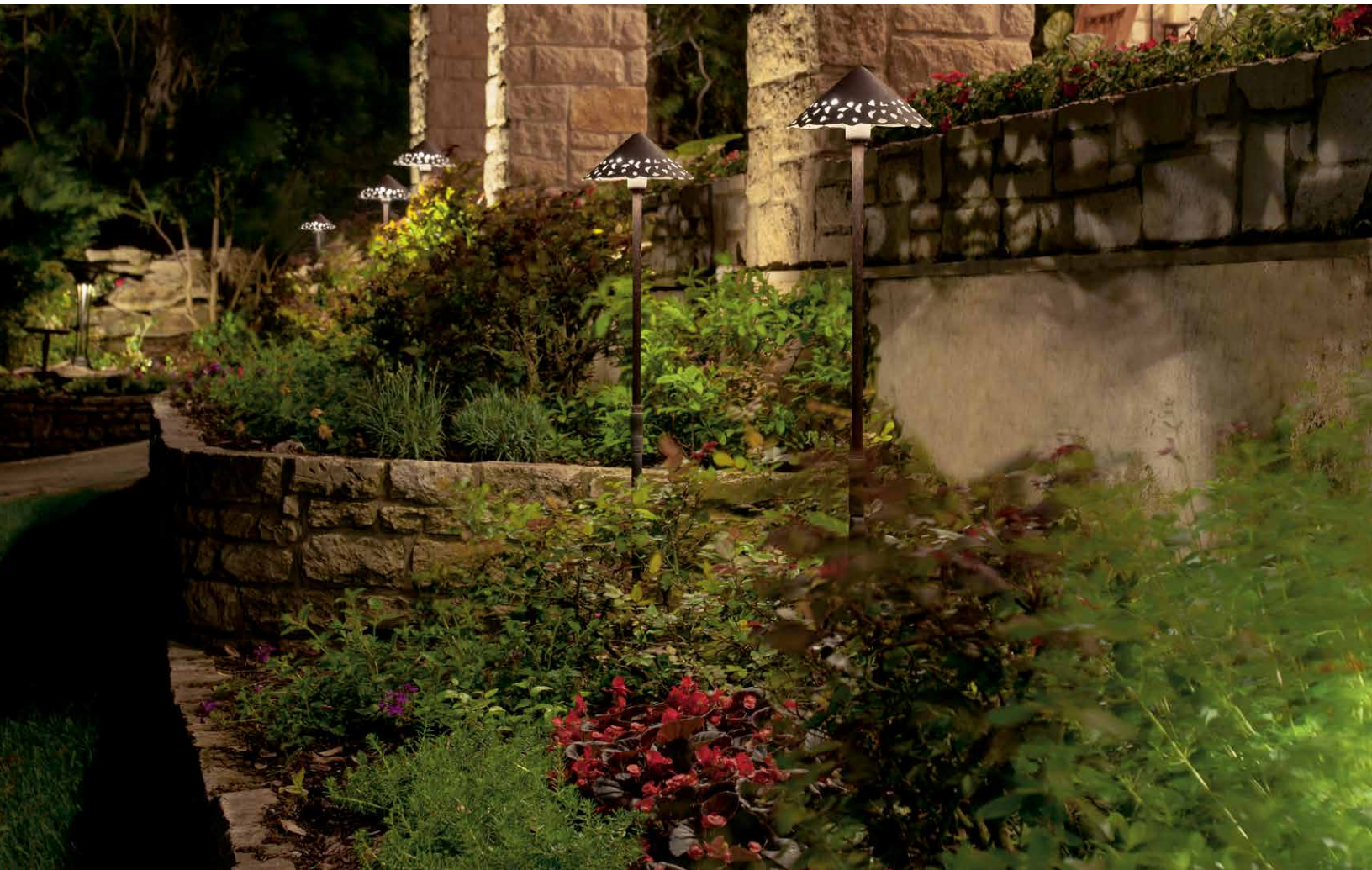
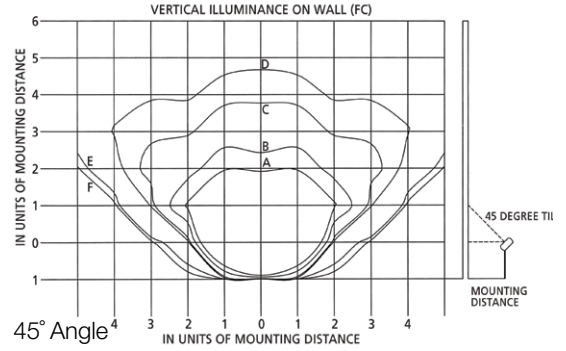

HID BOLLARD PHOTOMETRICS from page 179

15215AZT & BKT - 50-W Metal Halide
Footcandles/Distance from Fixture Center

Bollard Height	1'-0"	2'-0"	3'-0"	4'-0"	5'-0"	6'-0"
18"	10.4	19.6	10.9	5.7	3.2	1.8
24"	6.1	12.4	11.3	6.3	3.8	2.5
36"	3.4	5.7	7.2	6.4	4.7	3.3

15215AZT & BKT - 70-W Metal Halide
Footcandles/Distance from Fixture Center

Bollard Height	1'-0"	2'-0"	3'-0"	4'-0"	5'-0"	6'-0"
18"	15.8	26.6	15.5	8.9	5.5	3.3
24"	8.4	16.4	17.2	8.8	5.9	4.2
36"	4.8	8.5	9.8	9.7	7.0	4.6

15215AZT & BKT - 100-W Metal Halide
Footcandles/Distance from Fixture Center

Bollard Height	1'-0"	2'-0"	3'-0"	4'-0"	5'-0"	6'-0"
18"	21.3	48.1	23.8	11.9	6.1	3.6
24"	12.4	29.0	24.8	13.4	8.1	4.7
36"	6.9	11.3	14.6	13.2	8.5	6.1

15221AZT & BKT - 50-W Metal Halide
Footcandles/Distance from Fixture Center

Bollard Height	1'-0"	2'-0"	3'-0"	4'-0"	5'-0"	6'-0"
18"	15.3	20.8	11.1	5.1	2.7	1.4
24"	9.5	13.6	11.7	5.9	3.5	2.3
36"	5.4	6.9	7.6	6.5	4.5	2.9

15221AZT & BKT - 70-W Metal Halide
Footcandles/Distance from Fixture Center

Bollard Height	1'-0"	2'-0"	3'-0"	4'-0"	5'-0"	6'-0"
18"	24.5	29.9	16.5	8.2	5.0	2.7
24"	14.5	19.8	19.2	8.8	5.7	4.0
36"	8.3	10.8	11.1	10.3	6.9	4.5

15221AZT & BKT - 100-W Metal Halide
Footcandles/Distance from Fixture Center

Bollard Height	1'-0"	2'-0"	3'-0"	4'-0"	5'-0"	6'-0"
18"	33.9	46.7	21.4	9.9	4.8	2.2
24"	20.9	28.4	25.5	12.3	6.7	4.2
36"	12.4	14.3	15.4	14.2	9.7	6.2

15226AZT & BKT - 50-W Metal Halide
Footcandles/Distance from Fixture Center

Bollard Height	1'-0"	2'-0"	3'-0"	4'-0"	5'-0"	6'-0"
18"	8.7	17.9	10.5	5.4	3.1	2.1
24"	5.3	11.6	10.5	5.9	3.6	2.5
36"	3.1	5.2	6.5	6.1	4.4	3.1

15226AZT & BKT - 70-W Metal Halide
Footcandles/Distance from Fixture Center

Bollard Height	1'-0"	2'-0"	3'-0"	4'-0"	5'-0"	6'-0"
18"	14.3	26.7	15.2	8.9	5.4	2.9
24"	8.3	16.3	8.9	8.8	6.0	4.0
36"	4.8	8.1	9.5	9.5	6.7	4.6

15226AZT & BKT - 100-W Metal Halide
Footcandles/Distance from Fixture Center

Bollard Height	1'-0"	2'-0"	3'-0"	4'-0"	5'-0"	6'-0"
18"	18.5	38.3	20.4	10.5	5.6	3.6
24"	10.5	23.6	22.0	12.4	7.5	4.5
36"	6.3	10.6	14.2	12.6	9.0	6.4

FLAG POLE ILLUMINATION

- Flag poles used in a residential yard can usually be effectively lit with two fixtures
- Poles positioned on commercial or large residential lots will typically require three lighting fixtures
- The fixtures should be placed 180° apart if using two and 120° apart if using three
- The fixtures should be located 6" to 3' from the flag pole in low-voltage residential applications. For large residential, commercial and line-voltage applications, fixtures should be from 12" to 3' from the base of the pole
- Aim the fixture at the ball at the top of the flagpole



Installation 6" to 3' from base of flagpole

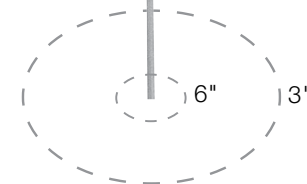

Please use the chart below to determine the recommended quantity of fixtures, lamp wattage and lamp type.

Pole Height	Typical Flag Size	Quantity of Fixtures	Lamp Wattage	Lamp Beam Spread	Kichler LED Option
12' to 20'	3' x 5'	2	20-W	NSP 10° to 15°	16003
25'	4' x 6'	2	35-W	NSP 10° to 15°	16006
30'	5' x 8'	2 or 3	35-W	NSP 10° to 15°	16006
35'	6' x 10'	3	35-W	NSP 10° to 15°	16006
Taller than 35'	10' +	3	50-W	NSP 10° to 15°	16009 or 16012

PICTORIAL INDEX

DESIGN PRO LED PATH & SPREAD



15800
AZT, BBR
Page 12



15801
TZT
Page 9



15802
TZT
Page 12



15803
AZT
Page 12



15804
AZT
Page 13



15805
BKT
Page 14

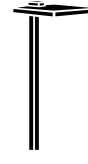

15806
BKT
Page 14



15807
AZT, BBR
Page 09



15810
AZT, BBR,
BE, BKT
Page 17



15843
CO, NBK,
TZT
Page 10



15850
CO
Page 11



15857
AZT
Page 9



15870
AZT, BBR,
BE, BKT
Page 16



15871
BBR, TZT
Page 10

DESIGN PRO LED DECK & PATIO



15750
TZT
Page 23



15763
TZT
Page 23



15764
AZT, BBR,
WHT
Page 25



15744
AZT, BBR,
CO, GRY,
SD, WHT
Page 32



15745
AZT, BBR,
CO, GRY,
SD, WHT
Page 32

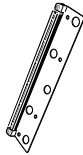

15746
AZT, BBR,
CO, GRY,
SD, WHT
Page 33



15755
AZT, BBR,
CO, GRY,
SD, WHT
Page 35

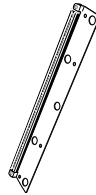

15756
AZT, BBR,
CO, GRY,
SD, WHT
Page 33

DESIGN PRO LED 12V ACCENT



**16000,
16001,
16002**
AZT, BBR,
BE, BKT, WHT
Page 45



**16003,
16004,
16005**
AZT, BBR,
BE, BKT, WHT
Page 46



**16006,
16007,
16008**
AZT, BBR,
BE, BKT, WHT
Page 47



**16204,
16205,
16208**
AZT, BBR, WHT
Page 53

DESIGN PRO LED ACCENT



**15731,
15732,
15733**
AZT, BBR, BKT
Page 58



**15741,
15742,
15743**
AZT, BBR, BKT
Page 58



**15751,
15752,
15753**
AZT, BBR, BKT
Page 58



15861
AZT, BBR, BKT
Page 61



16070
AZT, BBR, BKT
Page 60

PICTORIAL INDEX

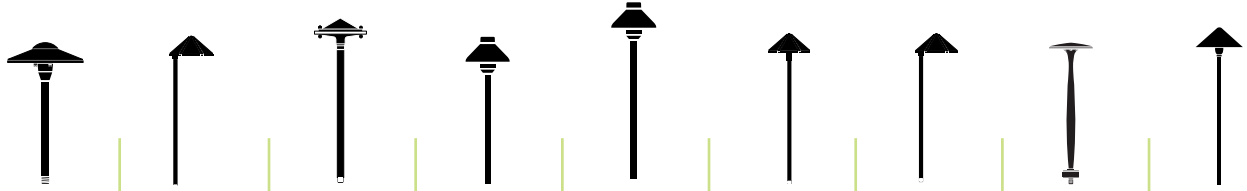

15811
AZT, BE
Page 17

15815
AZT, BE, BKT
Page 15

15817
AZT, BN
Page 14

15820
AZT, BBR, CO
Page 21

15821
AZT, BBR, CO
Page 21

15826
AZT, BE, BKT
Page 16

15827
BBR
Page 15

15833
AZT
Page 13

15839
CO, TZT
Page 11



15765
AZT, BBR, BE
BKT, WHT
Page 24

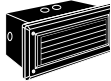

15773
AZT
Page 25



15774
AZT
Page 25



15780
AZT
Page 26



15782
AZT, BBR,
BKT, CO, WHT
Page 26

DESIGN PRO LED HARDSCAPE



15734
AZT, BBR,
CO, GRY,
SD, WHT
Page 34



15735
AZT, BBR,
CO, GRY,
SD, WHT
Page 34



15736
AZT, BBR,
CO, GRY,
SD, WHT
Page 35



**16009,
16010,
16011**
AZT, BBR,
BE, BKT, WHT
Page 48



**16012,
16013,
16014**
AZT, BBR,
BE, BKT, WHT
Page 49

DESIGN PRO LED 12V IN-GROUND



**16030,
16031,
16032**
BBR
Page 63



**16033,
16034,
16035**
BBR
Page 64



**16036,
16037,
16038**
BBR
Page 65

DESIGN PRO LED 120V ACCENT



**16200,
16201,
16206**
AZT, BBR, WHT
Page 51



**16202,
16203,
16207**
AZT, BBR, WHT
Page 52

DESIGN PRO LED WELL LIGHT



**15767,
15768,
15769**
BKT
Page 66



**15728,
15747,
15748**
BKT
Page 66



**15729,
15757,
15758**
BKT
Page 66

DESIGN PRO LED WATER/ACCENT



15711
SS
Page 69

PICTORIAL INDEX

PATH & SPREAD



15005
AZT, BKT,
Page 95



15310
AZT, AZT6,
BE, BKT
Page 98



15011
AZT, BKT,
Page 96



15313
TZG
Page 82



15314
AZT, MST
Page 74



15315
AZT, AZT6,
BE, BKT
Page 95



15317
AZT, BN
Page 92



15318
AZT
Page 92

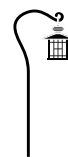

15319
PZ
Page 84

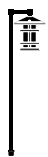

15322
AGZ
Page 85



15350
CO
Page 83



15351
CO
Page 83



15352
OZ
Page 87



15360
AZT
Page 93



15365
CV
Page 85



15367
TZT
Page 86



15369
TZT
Page 75

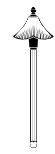

15379
OZ
Page 73

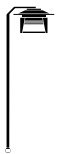

15391
OZ
Page 84



15392
OZ
Page 84



15429
TZT
Page 78



15435
AMB, PP, RD
Page 89



15436
OZ
Page 74



15437
TZT
Page 79



15438
OB, OZ
Page 86



15439
CO, OB,
OB6, TZT
Page 94



15443
CO, OB,
OB12, TZT,
VG
Page 80



15444
OZ
Page 82



15446
OZ
Page 73



15447
OZ
Page 73

SPECIALTY



15123
BK
Page 102

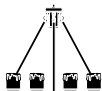

15402
OZ
Page 101

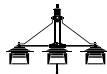

15409
OZ
Page 101

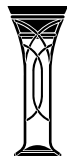

15415
TZT
Page 102

DECK & PATIO



15021
VGB
Page 108



15045
AZT
Page 110



15047
OZ
Page 105















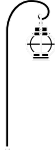



15064
AZT, BBR,
BN, WHT
Page 109





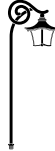







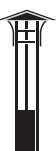



15065
AZT, BBR,
BKT, WHT
Page 109

PICTORIAL INDEX







								
15323 AZT, BKT, TZT Page 97	15326 AZT, AZT6, BKT Page 96	15328 AZT Page 94	15330 OZ Page 79	15333 TZT Page 93	15334 OB Page 87	15336 BKT, TZT Page 97	15347 VGB Page 74	15349 MST Page 81

								
15393 OZ Page 75	15401 AZT Page 80	15410 AZT, BE Page 99	15418 AZT Page 81	15420 AGZ Page 76	15421 AGZ Page 77	15422 AGZ Page 76	15423 AZT, BKT, TZT Page 97	15426 BKT Page 75





					
15449 TZT Page 77	15450 TZT Page 87	15457 AZT Page 78	15458 OZ Page 85	15470 AZT, BBR, BE, BKT Page 99	15471 BBR, TZT Page 81

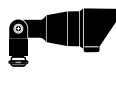

								
15066 AZT, WHT Page 111	15070 AZT Page 113	15071 OZ Page 106	15072 AZT, CO, WHT Page 113	15073 AZT Page 113	15074 AZT Page 113	15077 AZT Page 111	15079 AZT Page 112	15110 OZ Page 106

PICTORIAL INDEX



						
15123 BK Page 112	15165 AZ Page 110	15461 AZT Page 105	15468 AZT Page 110	15469 Tzt Page 108	15474 OZ Page 107	15479 Tzt Page 107

ACCENT		
	15309 AZT, BKT Page 119	15374 AZT, AZT20L 24, BE20L, BKT, BKT 20L 24 Page 120





				
15383 AZT Page 123	15385 AZT Page 125	15390 AZT Page 123	15395 AZT Page 124	15396 AZT Page 124

ACCENT Downlight			
	15087 AZT Page 127	15093 WH Page 127	15494 AZT Page 127







DESIGN PRO LED 120V ACCENT

		
16200, 16201, 16206 AZT, BBR, WHT Page 167	16202, 16203, 16207 AZT, BBR, WHT Page 168	16204, 16205, 16208 AZT, BBR, WHT Page 169

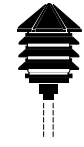



12 VOLT HID/ACCENT

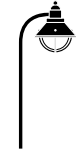

				
15230 AZT Page 172	15231 AZT, BKT Page 171	15241 AZT, BKT Page 171	15250 AZT Page 172	15251 AZT, BKT Page 171

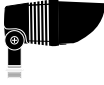





12 VOLT HID PATH & SPREAD

							
15205 BKT, Tzt Page 180	15211 AZT, BKT Page 180	15215 AZT, BKT Page 179	15221 AZT, BKT Page 179	15226 AZT, BKT Page 179	15232 AGZ Page 181	15236 BKT, Tzt Page 181	15239 OB, OZ Page 181

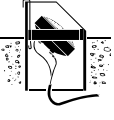





PICTORIAL INDEX





				
15382 BK Page 121	15384 AZT, AZT20L, AZT24, BBR, BKT, BKT24, CO Page 117	15397 AZT Page 118	15398 AZT Page 119	15484 AZT Page 118

		
15361 AZT, BKT Page 126	15363 BBR Page 126	15381 AZT, AZT6, BBR, BKT Page 122

						
15088 BK, BK12 Page 131	15092 BK Page 133	15190 BK Page 132	15192 BK Page 133	15194 AZ Page 132	15388 BK Page 131	15488 BK, BK12 Page 131

15191 BK Page 135

					
15255 AZT, BKT Page 172	15262 AZ Page 174	15263 AZ Page 174	15266 AZ Page 175	15268 AZ Page 173	15295 AZ Page 173

				
6051 AZ, WH Page 183	6052 AZ, WH Page 183	11077 AZT, BKT Page 182	11250 AZT, BKT Page 182	11251 AZT, BKT Page 182

KICHLER

World Headquarters
7711 E. Pleasant Valley Road • PO Box 318010
Cleveland, Ohio 44131-8010
www.landscapelighting.com
12-LD-2060-254
Catalog No. **K213**
Printed in USA 6.13. © Copyright All rights reserved. Kichler.

LEGEND

Wattages stated are the maximum recommended, however, you may use lower wattage bulbs to suit your lighting needs..

All electrical products are cUL, UL, ETL or CSA listed.

Because compliance and safety are important long after the installation is complete all Kichler Landscape Lighting low voltage transformers are listed or certified by UL, ETL, and/or CSA to the appropriate ANSI/UL 1838 standard for both the United States and Canada.

Finishes for fixtures installed outdoors are subject to change due to prolonged exposure to sunlight, airborne pollutants and other forms of weathering.

To serve you better, Kichler® Lighting reserves the right to make improvements to the products in this catalog. Therefore, some products may change during the life of the catalog and the product information contained in this catalog may also have changed.

WARRANTY

For complete warranty details, go to www.landscapelighting.com.

Kichler Products are not produced or associated with any Native American Indians, nor are they a Native American product or the product of a particular Indian, Indian tribe or Indian arts and crafts organization as defined by 25 U.S.C. §305 et. seq.

Cree®, CSA®, ETL®, Nichia®, UL® and other trademarks featured or referred to are the property of their respective trademark holders and Kichler claims no rights or interest in any of the trademarks.



NUMERIC INDEX

Product #	Page #	Product #	Page #	Product #	Page #	Product #	Page #	Product #	Page #	Product #	Page #
6051	183	15310	98	15426	75	15605	179, 187	15677	151	15767	66
6052	183	15313	82	15429	78	15607	149	15678	179	15768	66
11077	182	15314	74	15435	89	15608	188	15679	152	15769	66
11250	182	15315	95	15436	74	15609	150, 188	15680	152	15773	25
11251	182	15317	92	15437	79	15613	179, 187	15683	152	15774	25
15005	95	15318	92	15438	86	15614	179, 187	15686	151	15776	150
15011	96	15319	84	15439	94	15615	179, 187	15687	151	15777	149
15021	108	15322	85	15443	80	15616	188	15688	189	15778	150
15045	110	15323	97	15444	82	15620	189	15689	151	15780	26
15047	105	15326	96	15446	73	15623	188	15690	152	15782	26
15064	109	15328	94	15447	73	15624	188	15691	151	15787	152
15065	109	15330	79	15449	77	15625	188	15692	151	15800	12
15066	111	15333	93	15450	87	15626	188	15693	151	15801	9
15070	113	15334	87	15457	78	15628	189	15694	152	15802	12
15071	106	15336	97	15458	85	15630	189	15695	151	15803	12
15072	113	15347	74	15461	105	15631	151	15696	151	15804	13
15073	113	15349	81	15468	110	15632	151	15701	152	15805	14
15074	113	15350	83	15469	108	15633	151	15702	152	15806	14
15077	111	15351	83	15470	99	15634	152	15703	152	15807	9
15079	112	15352	87	15471	81	15635	150	15704	152	15810	17
15087	127	15360	93	15474	107	15637	188	15711	69	15811	17
15088	131	15361	126	15479	107	15638	188	15716	149	15815	15
15092	133	15363	126	15484	118	15639	188	15717	149	15817	14
15093	127	15365	85	15488	131	15640	189	15718	149	15820	21
15110	106	15367	86	15494	127	15641	151	15719	149	15821	21
15123	102, 112	15369	75	15501	153	15642	151	15728	66	15826	16
15165	110	15374	120	15502	153	15643	151	15729	66	15827	15
15190	132	15379	73	15503	153	15644	152	15731	58	15833	13
15191	135	15381	122	15504	153	15645	148, 187	15732	58	15839	11
15192	133	15382	121	15505	153	15647	149	15733	58	15843	10
15194	132	15383	123	15506	153	15648	189	15734	34	15850	11
15205	180	15384	117	15507	153	15649	149	15735	34	15857	9
15211	180	15385	125	15509	153	15650	189	15736	35	15861	61
15215	179	15388	131	15511	141, 153	15651	148	15741	58	15870	16
15221	179	15390	123	15529	147, 153	15652	148	15742	58	15871	10
15226	179	15391	84	15534	141, 153	15653	148	15743	58	15875	150
15230	172	15392	84	15556	141, 153	15656	148, 187	15744	32	15876	150
15231	171	15393	75	15557	141, 153	15657	148, 187	15745	32	15885	150
15232	181	15395	124	15565	141, 153	15658	148, 187	15746	33	15886	150
15236	181	15396	124	15570	148	15659	151	15747	66	15895	150
15239	181	15397	118	15572	161	15660	189	15748	66	15896	150
15241	171	15398	119	15575	148	15665	148, 187	15750	23	15BLMH100	179
15250	172	15401	80	15576	148	15666	148, 187	15751	58	15BLMH50	179
15251	171	15402	101	15578	148, 187	15667	148, 187	15752	58	15BLMH70	179
15255	172	15409	101	15579	153	15668	189	15753	58	15E120	142
15262	174	15410	99	15589	153	15670	153	15755	35	15E60	142
15263	174	15415	102	15598	161	15671	148, 179	15756	33	15IGMHS100	185
15266	175	15418	81	15599	161	15672	151	15757	66	15IGMHS175	185
15268	173	15420	76	15601	149, 187	15673	151	15758	66	15IGMHS35	185
15276	187	15421	77	15602	149, 187	15674	151	15763	23	15IGMHS70	185
15295	173	15422	76	15603	179, 187	15675	151	15764	25	15M100	142
15309	119	15423	97	15604	179, 187	15676	151	15765	24	15M200	142

NUMERIC INDEX

Product #	Page #	Product #	Page #	Product #	Page #	Product #	Page #	Product #	Page #
15M300	142	16037	65	17060	161	18021	159	18073	192
15M600	142	16038	65	17061	161	18022	159	18074	192
15MHS100	185	16050	152	17062	161	18023	159	18075	192
15MHS175	185	16051	152	17063	161	18024	159	18076	192
15MHS35	185	16060	151, 189	17066	161	18025	159	18077	192
15MHS70	185	16061	151, 189	17067	161	18026	159	18078	192
15MHT100	185	16062	151, 189	17070	161	18027	159	18079	192
15MHT175	185	16063	151, 189	17071	161	18028	159	18080	192
15MHT35	185	16064	150, 188	17072	161	18029	159	18081	192
15MHT70	185	16065	150, 188	17073	161	18036	159	18082	192
15PL100	142	16066	150, 188	17076	161	18037	159	18083	192
15PL200	142	16070	60	17077	161	18038	159	18084	192
15PL300	142	16200	51, 167	17078	161	18039	159	18085	192
15PL600	142	16201	51, 167	17080	161	18040	159	18086	192
15PL75	142	16202	52, 168	17081	161	18041	159	18087	192
15PL900	142	16203	52, 168	17082	161	18042	159	18088	192
15PR100	142	16204	53, 169	17083	161	18043	159	18089	192
15PR1200	142	16205	53, 169	17085	161	18044	159	18090	192
15PR200	142	16206	51, 167	17086	161	18045	192	18091	192
15PR300	142	16207	52, 168	17087	161	18046	192	18092	192
15PR600	142	16208	53, 169	17088	161	18047	192	18093	192
15PR75	142	16501	148	17090	161	18048	192	18094	192
15PR900	142	17011	161	17091	161	18049	192	18095	192
15PRD600	142	17012	161	17092	161	18050	192	18096	192
16000	45	17013	161	17093	161	18051	192	18097	192
16001	45	17015	161	18000	159	18052	192	18098	192
16002	45	17017	161	18001	159	18053	192	18099	192
16003	46	17021	161	18002	159	18054	192	18100	192
16004	46	17022	161	18003	159	18055	192	18101	192
16005	46	17023	161	18004	159	18056	192	18102	192
16006	47	17025	161	18005	159	18057	192	18103	192
16007	47	17030	161	18006	159	18058	192	18104	192
16008	47	17032	161	18007	159	18059	192	18105	192
16009	48	17033	161	18008	159	18060	192	18106	192
16010	48	17037	161	18009	159	18061	192	18107	192
16011	48	17039	161	18010	159	18062	192	18108	192
16012	49	17040	161	18011	159	18063	192	18109	192
16013	49	17044	161	18012	159	18064	192	18110	192
16014	49	17046	161	18013	159	18065	192	18111	192
16030	63	17047	161	18014	159	18066	192	18112	192
16031	63	17050	161	18015	159	18067	192	18113	192
16032	63	17051	161	18016	159	18068	192	18114	192
16033	64	17052	161	18017	159	18069	192	18115	192
16034	64	17055	161	18018	159	18070	192	18116	192
16035	64	17056	161	18019	159	18071	192		
16036	65	17057	161	18020	159	18072	192		

Ceiling Fans Outdoor/Indoor



CLIMATES™ Ceiling Fans & Accessories

Outfit your coastal escape with the finest, most durable wet-rated ceiling fans available for harsh outdoor elements. Repeated saltwater spray, extreme heat and cold, and constant high UV exposure, are no match for Climates superior construction. Fan bodies and select blades are crafted from durable ABS plastic, creating a superior level of corrosion resistance.



WET-Rated Ceiling Fans

Outdoor living spaces that are open to the elements, such as a pergola or a lanai are the ideal place for our wet location ceiling fans. Kichler® wet location ceiling fans feature a powder coated finish, stainless steel mounting hardware, aluminum support system and all-weather ABS blade options that help combat direct exposure to rain or repeated water spray.



DAMP-Rated Ceiling Fans

Kichler's Damp location rated ceiling fans are engineered for hot, damp, high-humidity areas such as an enclosed porch, master bath, or a laundry room, where high humidity or condensation are present. Damp-rated ceiling fans feature a powder coated finish with a galvanized undercoat and stainless steel mounting hardware. Many are available with ABS plastic blades.

See all of our ceiling fans and accessories at kichler.com





KICHLER®

Outdoor

Our newest outdoor lighting collections with updated styles and unique designs

See our complete line at kichler.com





KICHLER®

The Premium Choice in Landscape Lighting



Catalog No. **K213**
Printed in USA 6.13.
© Copyright All rights reserved. Kichler.

KICHLER.

Style to live by™