

Straight Blade Devices  
 15A, 125V, 2 Pole, 3 Wire Grounding  
 Hubbell-Pro™ Heavy Duty Duplex  
 Receptacles

# HUBBELL

## Features

- Slender/compact design
- Smooth face
- Triple wipe contacts

## Ordering Information

Description	Device Color	UPC	Catalog Number
Back and side wired	Black	783585109749	5252ABLK

## Listings

UL File No. E2186  
 Certified to CSA 22.2, No. 42 File 285  
 Fed. Spec. W-C-596  
 NEMA® WD-6 Compliant

## Specifications

Face	Nylon
Base	PBT
Contacts	Brass
Mounting Strap	Galvanized steel
Automatic Self-grounding Staple	Stainless steel
Mounting Screws	Zinc plated steel

## Performance

<b>Electrical</b>	
Current Interrupting	Certified for current interrupting at full rated current
Dielectric Voltage	Withstands 2,000V minimum
<b>Mechanical</b>	
Product Identification	Ratings are a permanent part of the device
Terminal Accommodation	#14-#10 AWG copper stranded or solid conductor only
Terminal Identification	Terminal wire leads identified in accordance with UL 498
<b>Environmental</b>	
Flammability	UL 94 V-2
Operating Temperatures	Maximum continuous 75°C; minimum -40°C (w/o impact)

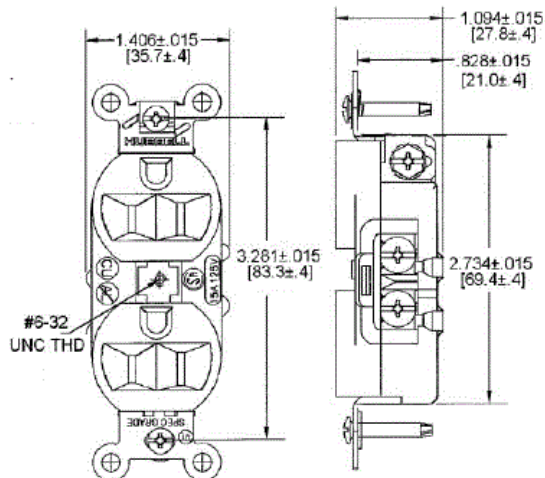

## Accessories

Wallplate or Weatherproof Cover Duplex Opening

## Resources

Customer Use Drawing  
 eCatalog

Dimensions in Inches (mm)

Hubbell Wiring Device-Kellems • Hubbell Incorporated (Delaware) • 40 Waterview Drive • Shelton, CT 06484

Phone (800) 288-6000 • Fax (800) 255-1031 • Specifications subject to change without notice.

