

Cable Management Horizontal Cable Manager M-Series Rail Mounted

HUBBELL

Features

- Cable rings align with patch panel adaptors to prevent patch cord kinks
- Steel construction provides ample strength for heavy cable loading
- Door hinges and is removeable to allow for easy addition of patch cords

Ordering Information

Rack Units	Depth	Catalog Number	UPC
2 RU	7"	HM27C	662620553412

Listings

EIA/ECA-310-E Universal Mounting Pattern

Specifications

Material	Steel
Wire Diameter	0.225"
Finish	Black Powder Coated

Characteristics

Cover	Included, hinged & removable
Pass through holes	Standard
Corresponding Vertical Cbl Mgr	VM Series

Accessories

Replacement Cover, 2U	HM2C
Black Velcro Roll	HVFBK575
9" Velco Strips, Yellow	MCCMV9YL10

Online Resources

Customer Drawings
Customer Use Drawing
eCatalog

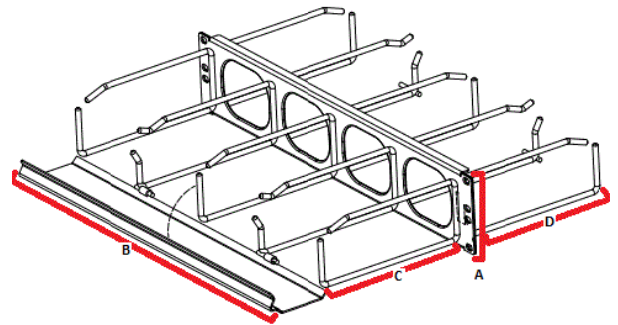

Dimensions- inches (mm)

A	2 RU, 3.5" (89)
B	19" (483)
C	7" (178)

